

2013

BELEUCHTUNG LKW
LIGHTING TRUCKS

Ed. 2



www.ermax.at
www.ral.at

DAF	Seite / page 1
Iveco	Seite / page 7
MAN	Seite / page 17
MB	Seite / page 29
RVI	Seite / page 48
Scania	Seite / page 55
Volvo	Seite / page 62
Index nach Artikelnummern	Seite / page 75
	<i>/ index item no.</i>
 OE → ERMAX	Seite / page 78



Ⓔ ECE Prüfzeichen / *ECE approval sign*

SM1 Seitenmarkierungsleuchte / *side marker lamp*

CE CE Prüfzeichen / *CE approval sign*



GGVS / ADR Prüfzeichen

Zugelassen für die Verwendung an Fahrzeugen zur Beförderung gefährlicher Güter

GGVS / ADR approval sign

Approved for use on vehicles for transport of dangerous goods

(E)

H4



DAF 95
Hauptscheinwerfer mit Blinker und
Positionsleuchte
Head lamp with indicator and position lamp

L

R

Artikelnummer
part number

098 056 500

098 056 501

Blinker / indicator

L

R

098 223 061

Streuscheibe / lens

L

R

098 109 700

098 109 701

Stecker / plug

099 110 618

(E)

H4



DAF 95 XF
Hauptscheinwerfer mit Blinker und
Positionsleuchte
Head lamp with indicator and position lamp

L

R

098 056 502

098 056 503

Blinker, Klarglas
indicator, clear lens

L

R

098 223 060

Streuscheibe / lens

L

R

098 109 702

098 109 703

Stecker / plug

099 110 618

(E)

H1 H7



099 110 006



099 110 618

**DAF LF Serie 01 >, CF Serie 03 >
XF 105 / XC 105 06 >**

Hauptscheinwerfer mit Blinker und
Positionsleuchte
Head lamp with indicator and position lamp

L

R

098 056 505

098 056 504

Streuscheibe / lens

L

R

098 109 706

098 109 707

Stecker / plug

L

R

099 110 006

099 110 618

(E)

XENON

D1S H1



DAF CF Serie 03 >, XF 105 / XC 105 06 >
Hauptscheinwerfer
mit Blinker und Positionsleuchte

L

R

098 056 690

098 056 691

Head lamp HID
with indicator and position lamp

Artikelnummer
part number

Ⓔ

H1 H3



**DAF 95XF, Serie LF 01 >
Serie CF, XF95 03 >
Serie XF / XC105 06 >**

Nebel- und Fernscheinwerfer ohne Rahmen
Fog lamp with high beam without frame

L

R

098 148 221

098 148 222

mit Rahmen / *with frame*

L

R

098 148 223

098 148 224

Stecker / *plug*

099 110 051

Ⓔ

H3



**DAF Serie LF 01 >, Serie CF / XF95 03 >
Serie XF / XC105 06 >**

Nebel- und Fernscheinwerfer
fog lamp with high beam

L

R

098 148 226

098 148 225

Stecker / *plug*

099 110 051

Ⓔ

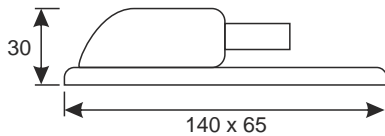

DAF Serie LF 01 >

Positionsleuchte vorne / *Position lamp, front*

098 230 010

Ⓔ



DAF CF Serie, XF95 03 >, XF / XC105 06 >

Positionsleuchte vorne
Position lamp, front

098 231 381

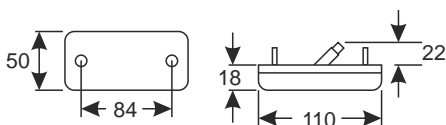

Fassung / *bulb holder*

098 291 381

Stecker / *plug*

099 110 006

Ⓔ

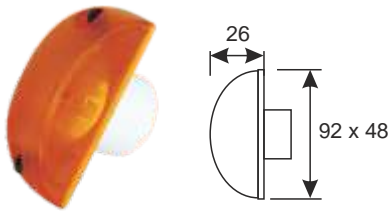

DAF LF 45 / 55 2001 >
Blinker / indicator



Artikelnummer
part number

098 221 837



Fassung Ba15s AMP JPT3
socket Ba15s AMP JPT3

098 291 510



Stecker / plug

099 110 378

Ⓔ



DAF 95, 95 XF
Blinker weiß / indicator white



098 223 060

Blinker orange / indicator amber



098 223 061

Ⓔ



DAF XF 95, CF 65, CF 75, CF 85 > 2003
DAF XF 105 / XC 105 2006 >

Blinker / indicator



098 223 062

Ⓔ



DAF XF 95, CF 65, CF 75, CF 85 > 2003
DAF XF 105 / XC 105 2006 >

Blinker / indicator



098 222 850

(E) + SM1



Premium

**DAF Serie LF 2001 >, CF 2003 >
XF95, XF105 / XC105 2006 >**

Seitenmarkierungsleuchte 24V 3W
mit Rückstrahler und 2-poligem AMP Anschluss
Side marker lamp
with reflex reflector and 2-pole AMP connector

Artikelnummer
part number

098 221 381

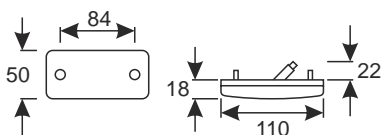

Eco

Seitenmarkierungsleuchte 24V 3W
mit Rückstrahler und 2-poligem AMP Anschluss
Side marker lamp with reflex reflector and 2-pole
AMP connector

198 221 381

Fassung / bulb holder

098 291 381



Stecker / plug

099 110 741

(E) + SM1

LED



DAF XF105, XC105 2006 >

Seitenmarkierungsleuchte 24V 3W
mit Rückstrahler und 2-poligem AMP Super Seal
Anschluss
Side marker lamp
with reflex reflector and 2-pole AMP Super Seal
connector

098 221 397



Stecker / plug

099 110 019

Schutzhülle / protection gasket

099 110 624

(E)



DAF Serie LF 2001 >

Kennzeichenbeleuchtung 12/24V Ba15s
mit Flachsteckanschluss 6,3mm
Numberplate lamp with flat plug connection 6,3mm

098 254 096

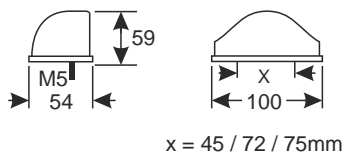

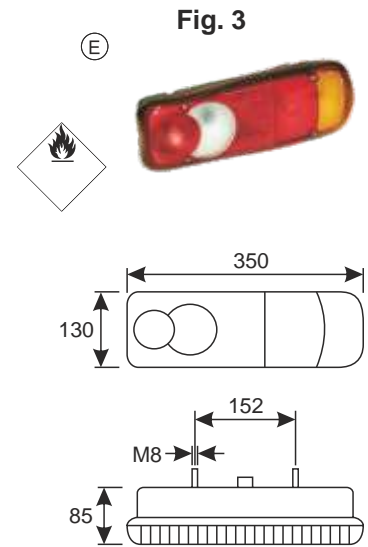
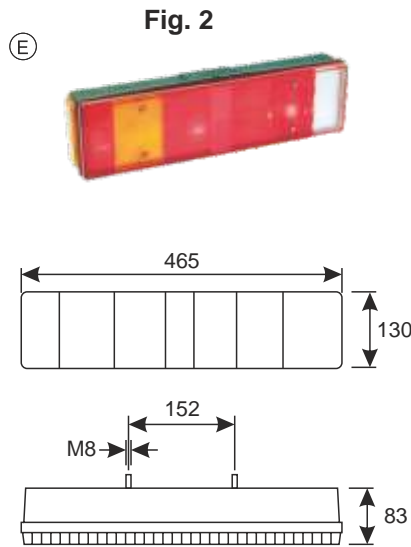
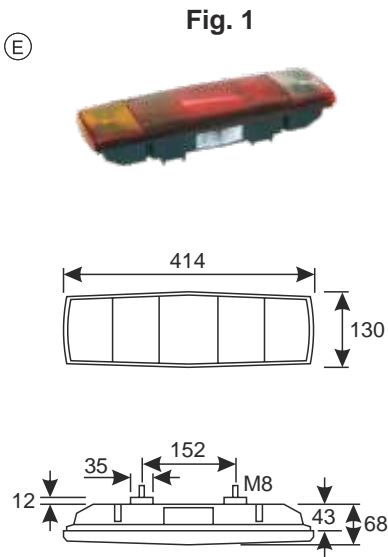

A



B



6-pol

C + Cs



6 pol AMP

Cs =

Anschlussstecker seitlich
connector lateral



098 292 775



099 110 618

DAF	Bezeichnung Name	Lichtscheibe / lens	Fig. Nr.	Links / left	Rechts / right	Blinker, Heck- und Brems- leuchte / indicator, tail- and stop lamp	2. Heckleuchte / tail lamp	Rückfahrleuchte Reverse lamp	Nebelschlussleuchte Rear fog lamp	Positionslampe hinten Tail position lamp	Seitenmarkierungsleuchte side marker lamp	Kennzeichenbeleuchtung Numberplate lamp	Rückstrahler Reflex reflector	Anschluss / connector	Vergleichsnummer comparison number	Artikelnummer part number
DAF		098 292 773	1	●	●	●	●	●	●			●	●	A	289 22 4	098 212 770
65/75/85/95		098 292 793	2	●	●	●	●	●	●	●	●		●	B		098 212 953
65/75/85/95		098 292 793	2	●		●	●	●	●	●	●	●	●	B		098 212 954
CF/XF		098 292 793	2		●	●	●	●	●	●	●		●	C	128 42 12	098 212 806
CF/XF		098 292 793	2	●		●	●	●	●	●	●	●	●	C	128 42 11	098 212 807
95XF/105XF		098 292 793	2	●		●	●	●	●	●	●	●	●	Cs	135 70 75	098 212 956
95XF/105XF		098 292 793	2		●	●	●	●	●	●	●		●	Cs	162 59 86	098 212 957
LF 45/55		098 292 919	3	●		●	●	●	●			●	●	C	140 17 13	098 212 910
LF 45/55		098 292 919	3		●	●	●	●	●				●	C	140 17 31	098 212 912
6 pol														B		098 292 775
6 pol AMP Stecker / plug														C		099 110 618
	Lichtscheibe gelb für Rückstrahler und Seitenbegrenzungsleuchte yellow lens for reflex reflector and side marker lamp														Fig. 2	098 292 959



Fig. 1



Fig. 2



Fig. 3

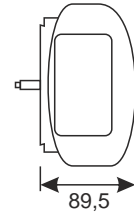
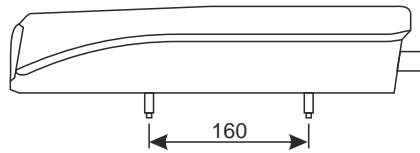
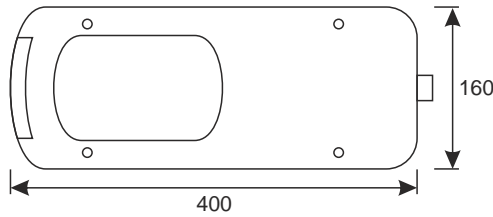

As + Ah



HDS CS

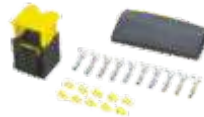

099 110 145

As =

Tyco HDS CS Anschlussstecker seitlich,
Tyco HDS CS connector lateral

Ah =

Tyco HDS CS Anschlussstecker hinten,
Tyco HDS CS connector backside

DAF CF, XF 11/2011 >	Bezeichnung Name	Lichtscheibe / lens	Fig. Nr.	Links / left	Rechts / right	Blinker, Heck- und Brems- leuchte / indicator, tail- and stop lamp	2. Heckleuchte / tail lamp	Rückfahrwarnleuchte Reverse lamp	Nebelschlussleuchte Rear fog lamp	Rückfahralarm backup alarm	Seitenmarkierungsleuchte side marker lamp	Kennzeichenbeleuchtung Numberplate lamp	Rückstrahler Reflex reflector	Anschluss / connector	Vergleichsnummer comparison number	Artikelnummer part number
DAF CF / XF	098 292 892	1		●	●	●	●	●	●		●		●	As	1875576	098 212 903
DAF CF / XF	098 292 891	2		●		●	●	●	●		●	●	●	As	1875577	098 212 904
DAF CF / XF	098 292 892	3		●	●	●	●	●	●	●			●	As	1875578	098 212 905
DAF CF / XF	098 292 892	1		●	●	●	●	●	●		●		●	Ah	1875579	098 212 906
DAF CF / XF	098 292 891	2		●		●	●	●	●		●	●	●	Ah	1875580	098 212 907
DAF CF / XF	098 292 892	3		●	●	●	●	●	●	●			●	Ah	1875581	098 212 908
HDS CS Stecker / Plug															099 110 145	
Rückfahrwarner für Leuchte rechts / reverse alarm, for right tail lamp															099 450 995	

		Artikelnummer part number		
(E)	H4		Iveco Eurocargo 91 - 04 Hauptscheinwerfer mit Positionsleuchte und Leuchtweitenregulierung <i>Head lamp with position lamp and levelling device</i>	L R 198 054 315 198 054 316
(E)	H1 H3		Iveco Eurocargo 91 - 04 Nebel- und Fernscheinwerfer <i>fog lamp with high beam</i>	L R 098 055 003 098 055 004
		Stecker / plug	099 110 129	
(E)		 	Iveco Eurocargo 91 - 04 Blinker / indicator	L R 098 222 317
		 	Iveco Eurocargo 91 - 04 Blinker / indicator	L R 098 222 318
(E)	H7 H7	  	Iveco Eurocargo 04 > Hauptscheinwerfer mit Positionsleuchte und Leuchtweitenregulierung <i>Head lamp with position lamp and levelling device</i>	L R 098 055 315 098 055 316
		 Hauptscheinwerfer mit Positionsleuchte und Leuchtweitenregulierung <i>Head lamp with position lamp and levelling device</i>	L R 298 055 315 298 055 316	
		Stecker / plug	L R 099 111 032 099 110 051	
		 099 111 032	 099 110 051	

		Artikelnummer part number	
(E) H1		Iveco Eurocargo 04 > Fernscheinwerfer / High beam	L R 098 089 335 098 089 336
		Stecker / plug	099 110 129
(E)		Iveco Eurocargo 04 > Positionsleuchte vorne, 24V Klarglas, mit 2-poligem Anschlusskabel 100mm	L R 098 230 040 098 230 050
		Position lamp, front <i>clear lens, with 2-pole connection cable 100mm</i>	
(E)		Iveco Eurocargo 04 > Blinker / indicator	L R 098 222 317
			
(E)		Iveco Eurocargo 04 > Blinker / indicator	L R 098 222 318
			
(E) + SM1		Iveco Eurocargo 04 > Premium Seitenmarkierungsleuchte 24V 3W mit Rückstrahler und 2-poligem AMP Anschluss Side marker lamp <i>with reflex reflector and 2-pole AMP connector</i>	098 221 381
			
(E)		Eco Seitenmarkierungsleuchte 24V 3W mit Rückstrahler und 2-poligem AMP Anschluss Side marker lamp with reflex reflector and 2-pole AMP connector	198 221 381
		Fassung / bulb holder	098 291 381
		Stecker / plug	099 110 741

Ⓔ

H7 H7



Eco

Iveco Stralis I 03-06

Hauptscheinwerfer mit Positionsleuchte und Leuchtweitenregulierung
Head lamp with position lamp and levelling device

◀ L

▶ R

Artikelnummer
part number

098 055 315

098 055 316

Premium

Hauptscheinwerfer mit Positionsleuchte und Leuchtweitenregulierung
Head lamp with position lamp and levelling device

◀ L

▶ R

298 055 315

298 055 316



099 111 032



099 110 051

Stecker / plug

◀ L

▶ R

099 111 032

099 110 051

Ⓔ

H1



Iveco Stralis I 03-06

Nebelscheinwerfer / fog lamp

◀ L

▶ R

098 055 094

Stecker / plug

099 110 129

Ⓔ

H1



Iveco Stralis I 03-06

Fernscheinwerfer / High beam

◀ L

▶ R

098 055 092

Stecker / plug

099 110 129

Ⓔ

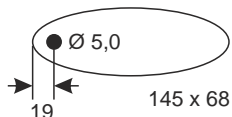

Iveco Stralis I 03-06

Positionsleuchte vorne, 24V
 Klarglas, mit 2-poligem Anschlusskabel 100mm
*Position lamp, front
 clear lens, with 2-pole connection cable 100mm*

◀ L

▶ R

098 230 040

098 230 050

Ⓔ



Iveco Stralis I 03-06

Blinker / indicator

◀ L







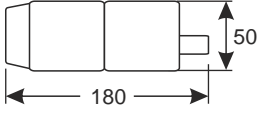

▶ R

098 223 920

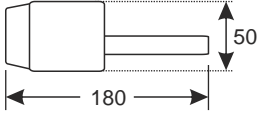
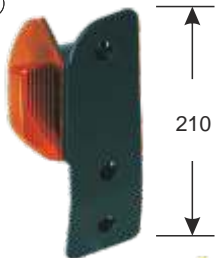
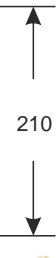
098 223 930

Stecker / plug



099 110 129

		Artikelnummer part number		
(E)		Iveco Stralis I 03-06 Blinker / indicator	◀ L R	098 222 317
				
(E)		Iveco Stralis I 03-06 Blinker / indicator	◀ L R	098 222 318
				
(E)		Iveco Stralis I 03-06 Blinker / indicator 3 Loch / 3 holes	◀ L R	098 222 321
				098 222 322
		Stecker / plug		099 110 129
(E)		Iveco Stralis I 03-06 Blinker / indicator 2 Loch / 2 holes	◀ L R	098 222 417
				098 222 418
		Stecker / plug		099 110 129
(E) + SM1		Premium Iveco Stralis I 03-06 Seitenmarkierungsleuchte 24V 3W mit Rückstrahler und 2-poligem AMP Anschluss Side marker lamp with reflex reflector and 2-pole AMP connector	◀ L R	098 221 381
				198 221 381
		Eco Iveco Stralis I 03-06 Seitenmarkierungsleuchte 24V 3W mit Rückstrahler und 2-poligem AMP Anschluss Side marker lamp with reflex reflector and 2-pole AMP connector	◀ L R	198 221 381
				Fassung / bulb holder
		Stecker / plug		099 110 741

		Artikelnummer part number	
	Iveco Stralis II 08 >, Trakker II Hauptscheinwerfer mit Positionsleuchte und Leuchtweitenregulierung <i>Head lamp with position lamp and levelling device</i>	L	098 055 117
		R	098 055 118
<hr/> Stecker / plug		L	099 111 032
		R	099 110 051
099 111 032	099 110 051		

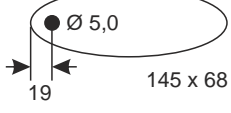
	Iveco Stralis II 08 >, Trakker II Fernscheinwerfer / high beam		098 055 096
		Premium Line	
	Eco Line	Fernscheinwerfer / high beam	198 055 096
	Iveco Stralis II 08 >, Trakker II Nebelscheinwerfer / fog lamp		098 055 098
		Premium Line	
	Eco Line	Nebelscheinwerfer / fog lamp	198 055 098
<hr/> Einbaurahmen für Fern-, Nebelscheinwerfer <i>Frame for high beam, fog lamp</i>		L	198 055 102
		R	198 055 103
Stecker / plug			099 110 129

	Iveco Stralis II 08 >, Trakker II Positionsleuchte vorne, 24V Klarglas, mit 2-poligem Anschlusskabel 100mm <i>Position lamp, front</i> clear lens, with 2-pole connection cable 100mm	L	098 230 040
		R	098 230 050
			

	Iveco Stralis II 08 >, Trakker II Blinker / indicator	L	098 222 323
		R	098 222 324
<hr/> Stecker / plug			099 110 129
			

ⓔ

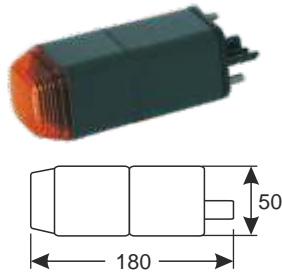

Iveco Stralis II 08 >, Trakker II
Blinker / indicator



Artikelnummer
part number
098 222 317

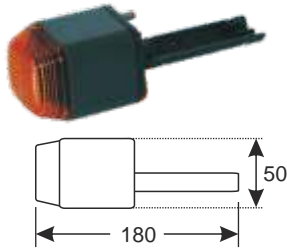

Iveco Stralis II 08 >, Trakker II
Blinker / indicator



098 222 318

ⓔ

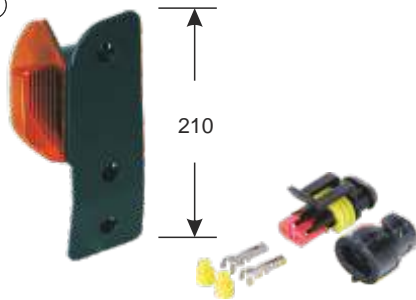

Iveco Stralis II 08 >, Trakker II
Blinker / indicator 3 Loch / 3 holes



098 222 321
098 222 322

Stecker / plug

099 110 129

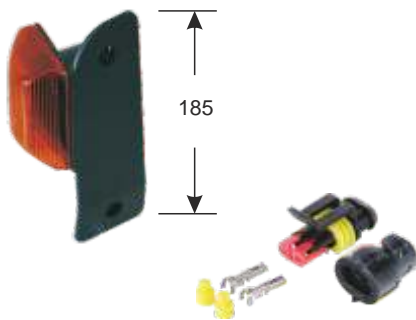

Iveco Stralis II 08 >, Trakker II
Blinker / indicator 2 Loch / 2 holes



098 222 417
098 222 418

Stecker / plug

099 110 129

Ⓔ + SM1



Premium

Iveco Stralis II 08 >, Trakker II

Seitenmarkierungsleuchte 24V 3W
mit Rückstrahler und 2-poligem AMP Anschluss
Side marker lamp
with reflex reflector and 2-pole AMP connector

Artikelnummer
part number

098 221 381

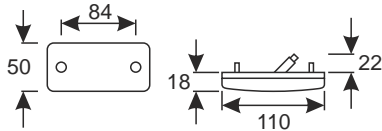

Eco

Seitenmarkierungsleuchte 24V 3W
mit Rückstrahler und 2-poligem AMP Anschluss
Side marker lamp with reflex reflector and 2-pole
AMP connector

198 221 381

Fassung / bulb holder

098 291 381



Stecker / plug

099 110 741

Ⓔ

H3 H4



Iveco Eurotech, Eurostar

Hauptscheinwerfer mit Positionsleuchte und
Leuchtweitenregulierung
Head lamp with position lamp and levelling device

L

R

198 055 313

198 055 314

Ⓔ

H1 H3



Iveco Eurotech, Eurostar

Nebel- und Fernscheinwerfer
fog lamp with high beam

L

R

098 055 003

098 055 004

Stecker / plug

099 110 129

Ⓔ



305 x 130 x 80



IVECO

Heckleuchte Daily 2006 > Pritsche
mit Bremsleuchte, Blinker, Rückfahrcheinwerfer und Nebelschlussleuchte
Tail lamp Daily 2006 > platform
with stop lamp, indicator, reverse lamp and rear fog lamp



Artikelnummer
part number

098 214 052
098 214 053

Lichtscheibe / lens



098 294 053
098 294 054



Stecker / plug

099 111 493

Ⓔ



685 x 191



IVECO

Heckleuchte Daily Kastenwagen 3,5t
mit Bremsleuchte, Blinker, Rückfahrcheinwerfer und Nebelschlussleuchte



098 214 055
098 214 056

Tail lamp Daily Van 3,5t
with stop lamp, indicator, reverse lamp and rear fog lamp



099 111 106



099 110 019

Stecker / plug

099 111 106
099 110 019

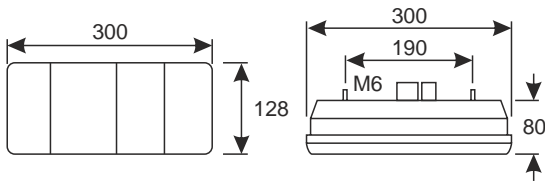
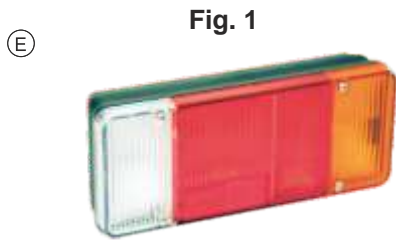

A

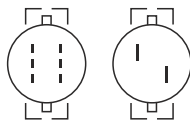

6+2 pol OLSA



099 110 647



099 110 049

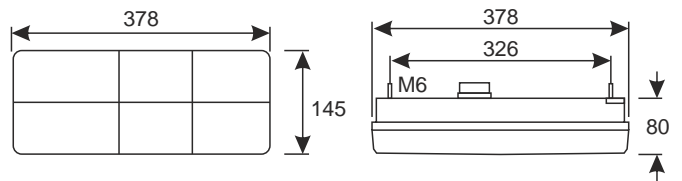
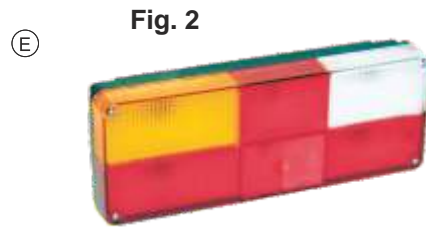

D

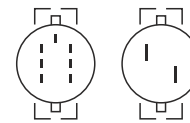

7+2 pol OLSA

IVECO	Bezeichnung Name	Lichtscheibe / lens	Fig. Nr.	Links / left	Rechts / right	Blinker, Heck- und Brems- leuchte / indicator, tail- and stop lamp	2. Heckleuchte / tail lamp	Rückfahrleuchte Reverse lamp	Nebelschlussleuchte Rear fog lamp			Kennzeichenbeleuchtung Numberplate lamp	Rückstrahler Reflex reflector	Anschluss / connector	Vergleichsnummer comparison number	Artikelnummer part number
Eurocargo	098 292 842	1	1	●	●	●	●	●					●	A		098 212 830
Eurocargo	098 292 847	1	1	●	●	●	●		●				●	A		098 212 835
Eurotech	098 292 852	2	2	●	●	●	●	●	●				●	D		098 212 855
Eurotech	098 292 862	2	2	●	●	●	●	●	●				●	D		098 212 865
Eurotech	098 292 852	2	2	●	●	●	●	●	●		●	●	●	D		098 212 875
	6 pol Olsa													A		099 110 647
	2 pol Olsa													A		099 110 049

Fig. 1

Ⓔ

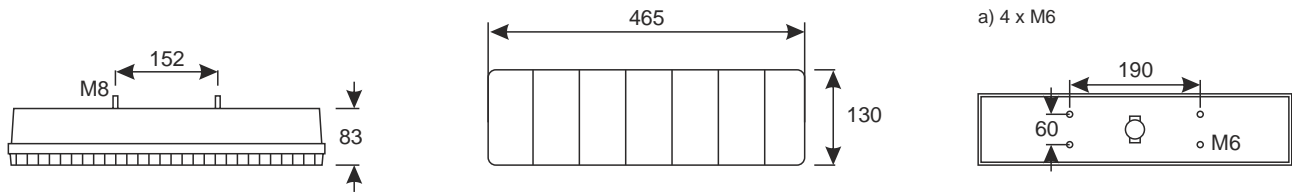

A

B

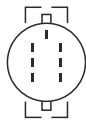

7 pol



6 pol



099 110 647

Bezeichnung Name	Lichtscheibe / lens	Fig. Nr.	Links / left	Rechts / right	Blinker, Heck- und Brems- leuchte / indicator, tail- and stop lamp	2. Heckleuchte / tail lamp	Rückfahrwarnwerfer Reverse lamp	Nebelschlussleuchte Rear fog lamp	Positionslampe hinten Tail position lamp	Seitenmarkierungsleuchte side marker lamp	Kennzeichenbeleuchtung Numberplate lamp	Rückstrahler Reflex reflector	Anschluss / connector	Vergleichsnummer comparison number	Artikelnummer part number
IVECO < 09/2011	098 292 793	1		●	●	●	●	●	●	●		●	A	99 463 242	098 212 961
IVECO < 09/2011	098 292 793	1	●		●	●	●	●	●	●	●	●	A	99 463 244	098 212 962
◆ IVECO > 09/2011	098 292 793	1	●		●	●	●	●	●	●		●	B	580 136 3428	098 212 991
◆ IVECO > 09/2011	098 292 793	1	●		●	●	●	●	●	●	●	●	B	580 136 3430	098 212 993
◆ IVECO > 09/2011	098 292 793	1		●	●	●	●	●	●	●		●	B	580 136 3431	098 212 992
◆ IVECO > 09/2011	098 292 793	1		●	●	●	●	●	●	●		●	B	580 136 3432	098 212 994*
7 pol													A		099 110 647
Lichtscheibe gelb für Rückstrahler und Seitenmarkierungsleuchte yellow lens for reflex reflector and side marker lamp														098 292 959	

* = mit Rückfahrwarner / with backup alarm

Ⓔ

H7 H7



MAN F2000

Hauptscheinwerfer mit Blinker und
Positionsleuchte

Head lamp with indicator and position lamp

L

R

Artikelnummer
part number

198 018 289

198 018 290

Hauptscheinwerfer mit Blinker,
Positionsleuchte und Leuchtweitenregulierung

*Head lamp with indicator, position lamp and
levelling device*

L

R

098 018 291

098 018 292

ZKW

Hauptscheinwerfer mit Blinker und
Positionsleuchte

Head lamp with indicator and position lamp

L

R

398 018 289

398 018 290

ZKW

Hauptscheinwerfer mit Blinker,
Positionsleuchte und Leuchtweitenregulierung

*Head lamp with indicator, position lamp and
levelling device*

L

R

398 018 291

398 018 292

Streuscheibe / lens

L

R

198 109 867

198 109 868

ZKW

Streuscheibe / lens

L

R

398 109 867

398 109 868

Ⓔ

H3 H3



ZKW

MAN F2000

Nebel- und Fernscheinwerfer
Fog lamp with driving lamp

L

R

198 148 339

198 148 338

Nebel- und Fernscheinwerfer
Fog lamp with driving lamp

L

R

398 148 339

398 148 338

Stecker / plug

099 111 401

Ⓔ

H3



230 x 120

MAN F2000

Nebelscheinwerfer Baustellen-Version
Fog lamp version for construction site

L

R

098 151 001

Ⓔ



ZKW

MAN F2000

Positionsleuchte mit Flachsteckanschluss
Position lamp with flat plug connector

098 200 800

Positionsleuchte mit Flachsteckanschluss
Position lamp with flat plug connector

398 200 800



Artikelnummer
part number

Ⓔ



MAN F2000
Blinker / indicator



098 222 805

Ⓔ



MAN F2000
Blinker / indicator



098 222 808

Ⓔ



MAN F2000
Blinker / indicator



910 222 603
910 222 604

Ⓔ + SM1



MAN F2000
Seitenmarkierungsleuchte
mit Rückstrahler und Flachsteckanschluss

24V 3W

098 221 370

*Side marker lamp
with reflex reflector and flat plug connector*

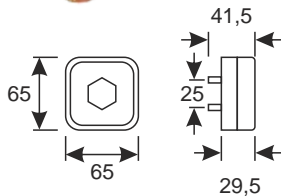

Seitenmarkierungsleuchte
mit Gummipendel, Rückstrahler und Flachsteckan-
schluss

098 221 371

*Side marker lamp
with rubber pendulum, reflex reflector and flat plug
connector*

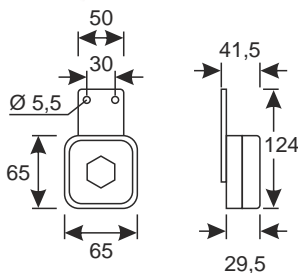

Fassung mit Anschlusskabel
Bulb holder with connection cable

098 291 375

Lichtscheibe / lens

098 291 372

Ⓔ + SM1

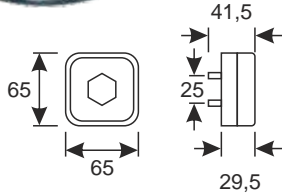

MAN F 2000

Seitenmarkierungsleuchte

24V

Anschlusskabel 1.500mm mit AMP Stecker

Side marker lamp, with wire 1.500 mm with AMP plug

AMP Stecker / plug

weiblich / female



098 221 373

AMP Stecker / plug

männlich / male



098 221 374

AMP Stecker / plug

weiblich / female



098 221 376

Fassung mit Anschlusskabel

Bulb holder with connection wire

098 291 375

Lichtscheibe / lens

098 291 372



099 111 410



099 111 439

Stecker / plug

099 111 410

Stecker / plug

099 111 439

Ⓔ + SM1

LED

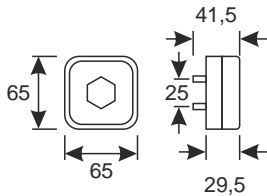

MAN F2000

Seitenmarkierungsleuchte LED

24V

mit Rückstrahler

Side marker lamp LED with reflex reflector



Anschlusskabel / connection cable 1500mm AMP-M

198 221 705



Seitenmarkierungsleuchte LED

24V

mit Rückstrahler

Side marker lamp LED with reflex reflector



Anschlusskabel / connection cable 1500mm AMP-M

398 221 705

Stecker / plug

AMP-M

099 111 439



099 111 439

Ⓔ



MAN F2000

Kennzeichenbeleuchtung

12/24V Ba15s

098 254 161

mit Flachsteckanschluss 6,3mm

Numberplate lamp with flat plug connection 6,3mm

Ⓔ

H7 H7

MAN TGA / TGL / TGM / TGS / LE 2000
Line Eco Hauptscheinwerfer Ecoline mit
 Positionsluchte
Head lamp with position lamp

L

R

Artikelnummer
part number

198 018 347
198 018 348

Line Premium Hauptscheinwerfer Premium Line
 mit Positionsluchte
Head lamp Premium line with position lamp

L

R

298 018 347
298 018 348

Line Eco Hauptscheinwerfer Ecoline mit Positionsluchte
 und Leuchtweitenregulierung
Head lamp with position lamp and levelling device

L

R

198 018 351
198 018 352

Line Premium Hauptscheinwerfer Premium Line
 mit Positionsluchte und Leuchtweitenregulierung
Head lamp Premium line with position lamp and levelling device

L

R

298 018 351
298 018 352



ZKW Hauptscheinwerfer mit Positionsluchte
Head lamp with position lamp

L

R

398 018 347
398 018 348

ZKW Hauptscheinwerfer
 mit Positionsluchte und Leuchtweitenregulierung
Head lamp Premium line with position lamp and levelling device

L

R

398 018 351
398 018 352

XENON

D2R H7

Hauptscheinwerfer Xenon mit Positionsluchte
 und Leuchtweitenregulierung
Head lamp HID with position lamp and levelling

L

R

098 018 361
098 018 360

Streuscheibe / lens

L

R

198 109 880
198 109 881

ZKW Streuscheibe / lens

L

R

398 109 880
398 109 881



Stecker / plug

099 111 648

099 111 648

Ⓔ

H4



Line
ECO

MAN TGA / TGL / TGM / TGS / LE 2000

Fernscheinwerfer ECO line
mit Nebelscheinwerfer und Blinker

High beam ECO line with fog lamp and indicator

L

R

Artikelnummer
part number

198 222 791

198 222 792

Line
Premium

Fernscheinwerfer Premium line
mit Nebelscheinwerfer und Blinker

**High beam Premium line
with fog lamp and indicator**

L

R

298 222 791

298 222 792

Line
Premium

Fernscheinwerfer mit Nebelscheinwerfer
und weißem Blinker

**High beam Premium line with fog lamp and white
indicator**

L

R

298 222 793

298 222 794



ZKW

Fernscheinwerfer mit Nebelscheinwerfer
und Blinker

**High beam
with fog lamp and indicator**

L

R

398 222 791

398 222 792

ZKW

Fernscheinwerfer mit Nebelscheinwerfer
und weißem Blinker

High beam with fog lamp and white indicator

L

R

398 222 793

398 222 794



Blinker / indicator

L

R

198 222 789

198 222 790



Stecker / plug

099 111 672

Ⓔ

LED



MAN TGA / TGL / TGM / TGS / LE 2000

Positionsleuchte vorne, 6 LED
Position lamp, front, 6 LED

24V

098 231 810

ZKW

Positionsleuchte vorne, 6 LED
Position lamp, front, 6 LED

24V

398 231 810

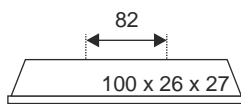

Ⓔ



MAN TGA / TGL / TGM / TGS / LE 2000

Blinker / indicator



Artikelnummer
part number

910 222 806



Blinker / indicator



398 222 806



Stecker / plug

099 111 689
099 111 688
099 111 686

Ⓔ



MAN TGA / TGL / TGM / TGS / LE 2000

Blinker / indicator



098 222 802



Stecker / plug

099 111 689
099 111 688
099 111 686

Ⓔ



MAN TGA / TGL / TGM / TGS / LE 2000

Artikelnummer
part number

Blinker, Lichtscheibe orange
Indicator, amber lens L R 198 222 801

Blinker, Lichtscheibe klar
Indicator, clear lens L R 198 222 803

ZKW

Blinker, Lichtscheibe orange
Indicator, amber lens L R 398 222 801

ZKW

Blinker, Lichtscheibe klar
Indicator, clear lens L R 398 222 803



099 111 689



099 111 688



099 111 686

Stecker / plug 099 111 689
099 111 688
099 111 686

Ⓔ + SM1

LED

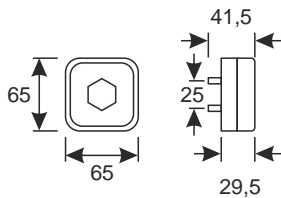

MAN TGA / TGL / TGM / TGS / LE 2000

Seitenmarkierungsleuchte LED 24V
mit Rückstrahler
Side marker lamp LED with reflex reflector

Anschlusskabel / connection cable 1500mm AMP-W 198 221 704

ZKW

Seitenmarkierungsleuchte LED 24V
mit Rückstrahler
Side marker lamp LED with reflex reflector

Anschlusskabel / connection cable 1500mm AMP-W 398 221 704



099 111 410

Stecker / plug AMP-W 099 111 410

Ⓔ

H7 H7



MAN TGX 08 >

Hauptscheinwerfer mit Positionsleuchte
Head lamp with position lamp

◀ L

▶ R

Artikelnummer
part number

098 018 200

098 018 201

Hauptscheinwerfer mit Positionsleuchte
und Tagfahrlicht
*Head lamp with position lamp and daytime
running light*

◀ L

▶ R

098 018 202

098 018 203

Hauptscheinwerfer mit Positionsleuchte
und Leuchtweitenregulierung
*Head lamp with position lamp and levelling
device*

◀ L

▶ R

098 018 204

098 018 205

Premium

Hauptscheinwerfer mit Positionsleuchte,
Tagfahrlicht und Leuchtweitenregulierung
*Head lamp with position lamp, daytime
running light and levelling device*

◀ L

▶ R

298 018 206

298 018 207

Hauptscheinwerfer mit Positionsleuchte
und Leuchtweitenregulierung
*Head lamp HID with position lamp and levelling
device*

◀ L

▶ R

098 018 208

098 018 209

Hauptscheinwerfer mit Positionsleuchte,
Tagfahrlicht und Leuchtweitenregulierung
*Head lamp HID with position lamp, daytime running
light and levelling device*

◀ L

▶ R

098 018 210

098 018 211

XENON D1R

H7 H7

XENON D1R

H7 H7

ZKW

Hauptscheinwerfer mit Positionsleuchte
Head lamp with position lamp

◀ L

▶ R

398 018 200

398 018 201

ZKW

Hauptscheinwerfer mit Positionsleuchte
und Tagfahrlicht
*Head lamp with position lamp and daytime
running light*

◀ L

▶ R

398 018 202

398 018 203

ZKW

Hauptscheinwerfer mit Positionsleuchte
und Leuchtweitenregulierung
*Head lamp with position lamp and levelling
device*

◀ L

▶ R

398 018 204

398 018 205

ZKW

Hauptscheinwerfer mit Positionsleuchte,
Tagfahrlicht und Leuchtweitenregulierung
*Head lamp with position lamp, daytime
running light and levelling device*

◀ L

▶ R

398 018 206

398 018 207

Streuscheibe / lens

◀ L

▶ R

198 109 883

198 109 884

ZKW

Streuscheibe / lens

◀ L

▶ R

398 109 883

398 109 884

LED

Tagfahrlicht / daytime running light

Ⓔ

H3 H4

Premium Line

MAN TGX 08 >
Fernscheinwerfer, Nebelscheinwerfer
und Abbiegelicht
High beam, fog lamp and curve lamp

◀ L
R ▶

Artikelnummer
part number

298 143 050
298 143 051



ZKW

Fernscheinwerfer, Nebelscheinwerfer
und Abbiegelicht
High beam, fog lamp and curve lamp

◀ L
R ▶

398 143 050
398 143 051

Streuscheibe / lens

◀ L
R ▶

198 109 885
198 109 886

ZKW

Streuscheibe / lens

◀ L
R ▶

398 109 885
398 109 886



Stecker / plug

099 111 672

Ⓔ

LED



MAN TGX 08 >
Positionsleuchte vorne, 6 LED
Position lamp, front, 6 LED

24V

098 231 810

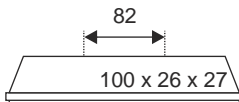

ZKW

Positionsleuchte vorne, 6 LED
Position lamp, front, 6 LED

24V

398 231 810

Ⓔ



MAN TGX 08 >
Blinker, Lichtscheibe klar
Indicator, clear lens

◀ L R ▶

198 222 803

ZKW

Blinker, Lichtscheibe klar
Indicator, clear lens

◀ L R ▶

398 222 803



099 111 689



099 111 688

Stecker / plug

099 111 689
099 111 688
099 111 686



099 111 686

(E) + SM1

LED



MAN TGX 08 >
Seitenmarkierungsleuchte LED 24V
 mit Rückstrahler
Side marker lamp LED with reflex reflector

Artikelnummer
part number

Premium



Anschlusskabel / connection cable 1200mm AMP-W

298 221 701



Anschlusskabel / connection cable 1500mm AMP-M

198 221 705

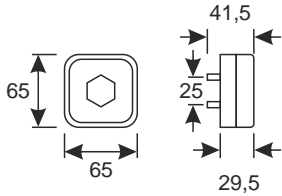

Seitenmarkierungsleuchte LED 24V
 mit Rückstrahler
Side marker lamp LED with reflex reflector

ZKW



Anschlusskabel / connection cable 1200mm AMP-W

398 221 701



Anschlusskabel / connection cable 1500mm AMP-M

398 221 705



099 111 439



099 111 410

Stecker / plug

AMP-W

099 111 410

AMP-M

099 111 439

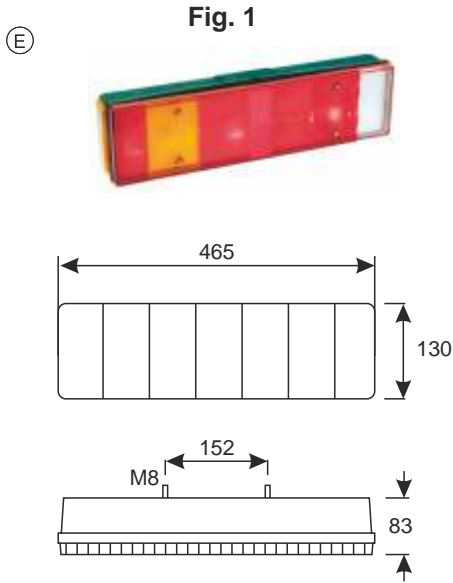

A



6 pol



098 292 775

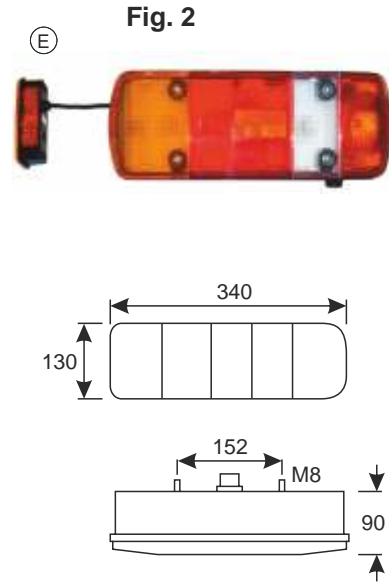

Bs



6 pol

Seitlicher Stecker
sidemounted plug



099 111 648

MAN TG-A, TG-L, TG-M, TG-S	Lichtscheibe / lens	Fig. Nr.	Links / left	Rechts / right	Blinker, Heck- und Brems- leuchte / indicator, tail- and stop lamp	2. Heckleuchte / tail lamp	Rückfahrcheinwerfer Reverse lamp	Nebelschlussleuchte Rear fog lamp	Positionslampe Tail position lamp	Seitenmarkierungsleuchte side marker lamp	Kennzeichenbeleuchtung Numberplate lamp	Rückstrahler Reflex reflector	Anschluss / connector	Vergleichsnummer comparison number	Artikelnummer part number
F2000	098 292 793	1	●	●	●	●	●	●	●	●	●	●	A	81 25225 6029	098 212 953
F2000	098 292 793	1	●		●	●	●	●	●	●	●	●	A	81 25225 6030	098 212 954
TG Serie, LE2000	098 293 182	2	●		●	●	●	●	●	●	●	●	A	81 25225 6531	910 213 050
TG Serie, LE2000	098 293 182	2		●	●	●	●	●	●	●	●	●	A	81 25225 6532	910 213 051
TG Serie, LE2000	098 292 793	1	●		●	●	●	●	●	●	●	●	Bs	81 25225 6519	098 212 956
TG Serie, LE2000	098 292 793	1		●	●	●	●	●	●	●	●	●	Bs	81 25225 6523	098 212 957
TG Serie, LE2000	098 292 793	1	●		●	●	●	●	●	●	●	●	Bs	81 25225 6522	098 212 958
6 pol Stecker System SCHLEMMER / connector system SCHLEMMER													A		098 292 775
6 pol Stecker AMP 1,5 / connector AMP 1,5													Bs		099 111 648
Lichtscheibe gelb für Rückstrahler und Seitenmarkierungsleuchte yellow lens for reflex reflector and side marker lamp													098 212 953, 098 212 954, 098 212 956, 098 212 957, 098 212 958		098 292 959

Fig. 1

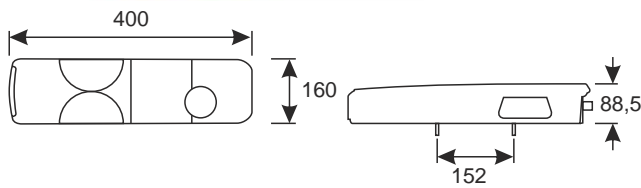
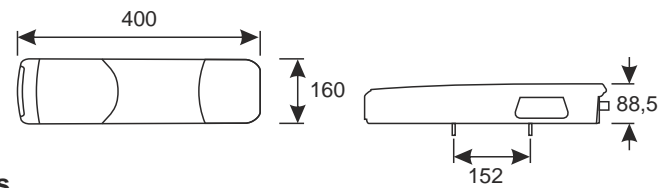

Fig. 2



Betriebsdauer der LED: ca. 30.000 Stunden
Operating time LED: ca. 30.000 hours



As



7 pol AMP



099 111 648

As =

Anschlussstecker seitlich
connector lateral

MAN TG-A, TG-L, TG-M, TG-S, TG-X,	Lichtscheibe / lens	Fig. Nr.	Links / left	Rechts / right	Blinker, Heck- und Brems- leuchte / indicator, tail- and stop lamp	2. Heckleuchte / tail lamp	Rückfahrwarnwerfer Reverse lamp	Nebelschlussleuchte Rear fog lamp	Rückfahrwarmer Back up alarm	Seitenmarkierungsleuchte side marker lamp	Kennzeichenbeleuchtung Numberplate lamp	Rückstrahler Reflex reflector	Anschluss / connector	Vergleichsnummer comparison number	Artikelnummer part number
	098 292 898	1	●		●	●	●	●		●	●	●	As	81 25225 6544	098 212 890
	098 292 899	1		●	●	●	●	●		●		●	As	81 25225 6545	098 212 891
	098 292 898	1	●		●	●	●	●	●	●		●	As	81 25225 6547	098 212 892
	098 292 895	2	●		●	●	●	●	●	●	●	●	As	81 25225 6532	098 215 890
	098 292 895	2		●	●	●	●	●	●	●		●	As	81 25225 6531	098 215 891
Vorschaltgerät / converter														für / for 098 215 890, -891	098 400 020
Rückfahrwarmer / backup alarm														für / for 098 212 892	099 450 995
AMP 1,5 Stecker / AMP 1,5 plug															099 111 648
Verbindungskabel mit AMP Stecker 4.000mm / AMP connector with wire 4.000mm															098 291 233

Ⓔ

H4



MB Actros I

Hauptscheinwerfer mit Positionsleuchte
Head lamp with position lamp



Artikelnummer
part number

198 081 117

198 081 118

Hauptscheinwerfer mit Positionsleuchte
und Leuchtweitenregulierung
Head lamp with position lamp and levelling device



198 081 317

198 081 318

Streuscheibe / lens



198 109 834

198 109 835

Umbausatz für Streuscheibe / *Repair kit lens*

098 109 093

Stecker / plug

099 110 620



Ⓔ

H4



MB Actros I

Hauptscheinwerfer mit Positionsleuchte
und Blinker
Head lamp with position lamp and indicator



198 081 119

198 081 120

Hauptscheinwerfer mit Positionsleuchte,
Blinker und Leuchtweitenregulierung
Head lamp with position lamp, indicator and levelling device



198 081 321

198 081 322

Streuscheibe / lens



198 109 834

198 109 835

Umbausatz für Streuscheibe / *Repair kit lens*

098 109 093

Stecker / plug

099 110 620



Ⓔ

H1

H4



MB Actros I

Hauptscheinwerfer mit Positionsleuchte
und Nebelscheinwerfer
Head lamp with position lamp and fog lamp



198 081 121

198 081 122

Hauptscheinwerfer mit Positionsleuchte
und Nebelscheinwerfer und Leuchtweiten-
regulierung
Head lamp with position lamp, fog lamp and levelling device



198 081 319

198 081 320

Streuscheibe / lens



198 109 834

198 109 835

Umbausatz für Streuscheibe / *Repair kit lens*

098 109 093

Stecker / plug

099 110 620



		Artikelnummer part number			
E			MB Actros I Fernscheinwerfer / High beam	L	098 143 011
				R	098 143 021

Premium		Fernscheinwerfer / High beam	L	298 143 011
			R	298 143 021

E			Line Eco Nebelscheinwerfer / fog lamp	L	098 153 016
				R	098 153 026

Premium		Nebelscheinwerfer / fog lamp	L	298 153 016
			R	298 153 026

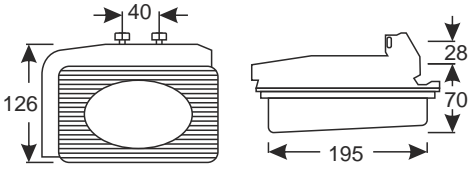

Montagerahmen / holder	L	098 143 910
	R	098 143 920

	Stecker / plug	099 110 386
---	-----------------------	-------------

E		Mercedes Benz Actros I Positionsleuchte vorne position lamp, front	L	098 230 020
			R	098 230 030

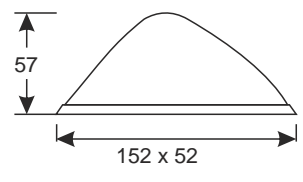

Ⓔ

H1 H7

MB Actros II
Eco Line Hauptscheinwerfer Eco Line
 mit Blinkleuchte
Head lamp Eco Line with indicator lamp

L R

Artikelnummer
part number

198 081 161
198 081 261

Premium Line Hauptscheinwerfer Premium Line
 mit Blinkleuchte
Head lamp Premium Line with indicator lamp

L R

298 081 161
298 081 261



Eco Line Hauptscheinwerfer Eco Line
 mit Blinkleuchte und Leuchtweitenregulierung
Head lamp Eco Line with indicator lamp and levelling device

L R

198 081 361
198 081 461

Premium Line Hauptscheinwerfer Premium Line mit
 Blinkleuchte und Leuchtweitenregulierung
Head lamp Premium Line with indicator lamp

L R

298 081 361
298 081 461

XENON D2R

H1

Hauptscheinwerfer mit Blinkleuchte und
 Leuchtweitenregulierung
Head lamp HID with indicator and levelling device

L R

098 081 334
098 081 335

Streuscheibe / lens

L R

198 109 832
198 109 833



Stecker / Plug

099 110 620

Ⓔ

H3



MB Actros II
Eco Line Nebelscheinwerfer ECO line
Fog lamp ECO line

L R

198 153 056
198 153 156

Premium Line Nebelscheinwerfer Premium line
Fog lamp Premium line

L R

298 153 056
298 153 156



Stecker / plug

099 111 116

Ⓔ





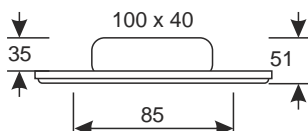

MB Actros II
 Positionsleuchte vorne mit Flachsteckanschluss
 und Gummiauflage

098 242 901

Position lamp, front, with flat plug connector and rubber base



		Artikelnummer part number	
E	H1 H7 	Premium Line MB Actros III Hauptscheinwerfer mit Blinkleuchte <i>Head lamp with indicator lamp</i>	L 298 081 330 R 298 081 331
		Premium Line Hauptscheinwerfer mit Blinkleuchte und Leuchtweitenregulierung <i>Head lamp with indicator and levelling device</i>	L 298 081 336 R 298 081 337
XENON D1S H1		Hauptscheinwerfer mit Blinkleuchte und Leuchtweitenregulierung <i>Head lamp HID with indicator and levelling device</i>	L 198 081 332 R 198 081 333
		Streuscheibe / lens	L 198 109 838 R 198 109 839
		Einbaurahmen / holder	L 098 109 842 R 098 109 843
		Chromrahmen / chrome rim	L 198 081 338 R 198 081 339
		 Stecker / plug	099 110 620

E	H3 	ECO Line MB Actros III Nebelscheinwerfer ECO line <i>Fog lamp ECO line</i>	L 198 153 056 R 198 153 156
		Premium Line Nebelscheinwerfer Premium line <i>Fog lamp Premium line</i>	L 298 153 056 R 298 153 156
	 Stecker / plug	099 111 116	

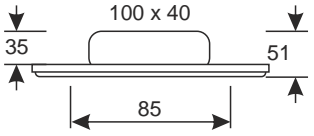
E		MB Actros III Positionsluchte vorne mit Flachsteckanschluss und Gummiauflage <i>Position lamp, front, with flat plug connector and rubber base</i>	098 242 901
			

Artikelnummer
part number

Ⓔ



098 223 005

MB Actros I

Blinker mit Glühlampe 24V, orange Lichtscheibe **098 223 005**
Indicator with bulb 24V, amber lens



098 223 007

Blinker mit Glühlampe 24V, klare Lichtscheibe **098 223 007**
Indicator with bulb 24V, clear lens



Stecker / plug **099 110 006**

Ⓔ



MB Actros I

Blinker mit 24V Glühlampe **098 223 001**
Indicator with bulb 24V

098 223 002



Stecker / plug **099 110 010**

Ⓔ



MB Actros I, II, III

Blinker mit Anschlusskabel und Stecker **198 223 044**
Indicator with connection wire and plug

198 223 045

Lichtscheibe / lens **098 223 009**

098 223 010



Stecker / plug **099 110 469**

Ⓔ + SM1

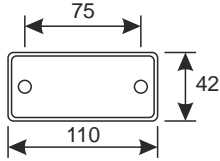

MB Actros I
Seitenmarkierungsleuchte
mit Rückstrahler

24V

Artikelnummer
part number

098 221 220

Side marker lamp with reflex reflector

Fassung / bulb holder

098 291 358

Fassung mit Anschlusskabel 200mm
bulb holder with connection cable 200mm

098 291 357

Anbauwinkel 90° / installation bracket 90°

098 293 309

Stecker / plug

099 110 010

Ⓔ + SM1

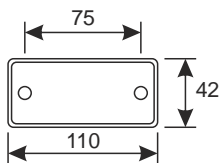

MB Actros I, II
Seitenmarkierungsleuchte
mit Rückstrahler

24V

098 221 225

Side marker lamp with reflex reflector

Anbauwinkel 90° / installation bracket 90°

098 293 309

Stecker / plug

099 110 006

Artikelnummer
part number

(E) + SM1

LED

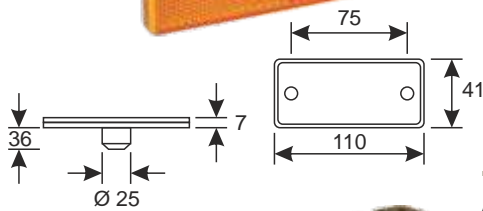
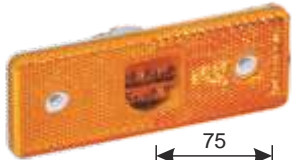

MB Actros II

Seitenmarkierungsleuchte 4 LED

24V 1,5W

098 221 222

mit Rückstrahler und Anschlusskabel 200mm, IP67

Side marker lamp 4 LED, with reflex reflector and connection cable 200mm, IP67



Anbauwinkel 90° / installation bracket 90°

098 293 309



Stecker / plug

099 110 010

(E) + SM1

LED

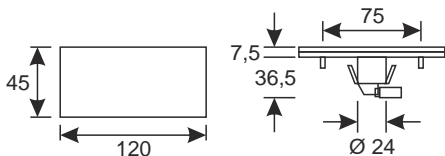

MB Actros II, III

Seitenmarkierungsleuchte

24V

198 221 357

mit 6 LED und Rückstrahler, IP67

Side marker lamp, with 6 LED and reflex reflector, IP67



Stecker / plug

099 111 116



Seitenmarkierungsleuchte

24V

098 221 357

mit 6 LED und Rückstrahler, Anschlusskabel 500mm, IP67

Side marker lamp 24V

with 6 LED and reflex reflector, IP 67, connection cable 500mm

Ⓔ

H4



MB Axor I

Hauptscheinwerfer mit Positionsleuchte
Head lamp with position lamp



Artikelnummer
part number

198 081 117

198 081 118

Hauptscheinwerfer mit Positionsleuchte
und Leuchtweitenregulierung
Head lamp with position lamp and levelling device



198 081 317

198 081 318

Streuscheibe / lens



198 109 834

198 109 835

Umbausatz für Streuscheibe / *Repair kit lens*

098 109 093

Stecker / plug

099 110 620



Ⓔ

H4



MB Axor I

Hauptscheinwerfer mit Positionsleuchte
und Blinker
Head lamp with position lamp and indicator



198 081 119

198 081 120

Hauptscheinwerfer mit Positionsleuchte,
Blinker und Leuchtweitenregulierung
Head lamp with position lamp, indicator and levelling device



198 081 321

198 081 322

Streuscheibe / lens



198 109 834

198 109 835

Umbausatz für Streuscheibe / *Repair kit lens*

098 109 093

Stecker / plug

099 110 620



Ⓔ

H1

H4



MB Axor I

Hauptscheinwerfer mit Positionsleuchte
und Nebelscheinwerfer
Head lamp with position lamp and fog lamp



198 081 121

198 081 122

Hauptscheinwerfer mit Positionsleuchte
und Nebelscheinwerfer und Leuchtweiten-
regulierung
Head lamp with position lamp, fog lamp and levelling device



198 081 319

198 081 320

Streuscheibe / lens



198 109 834

198 109 835

Umbausatz für Streuscheibe / *Repair kit lens*

098 109 093

Stecker / plug

099 110 620



Ⓔ

H3



MB Axor I
Line Eco Fernscheinwerfer / High beam

L

R

Artikelnummer
part number

098 143 011
098 143 021

Line Premium Fernscheinwerfer / High beam

L

R

298 143 011
298 143 021

Ⓔ

H3



Line Eco Nebelscheinwerfer / fog lamp

L

R

098 153 016
098 153 026

Line Premium Nebelscheinwerfer / fog lamp

L

R

298 153 016
298 153 026

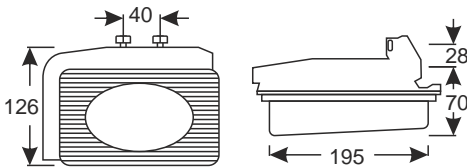

Montagerahmen / holder

L

R

098 143 910
098 143 920



Stecker / plug

099 110 386

Ⓔ



MB Axor I
 Positionsleuchte vorne
 position lamp, front

L

R

098 230 020
098 230 030

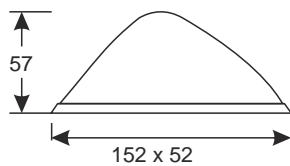

Ⓔ

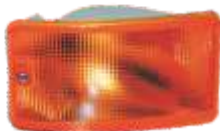

098 223 005

MB Axor I
 Blinker mit Glühlampe 24V, orange Lichtscheibe
 Indicator with bulb 24V, amber lens

L

R

098 223 005



098 223 007

Blinker mit Glühlampe 24V, klare Lichtscheibe
 Indicator with bulb 24V, clear lens

L





R

098 223 007

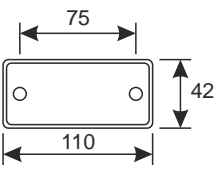

Stecker / plug

099 110 006

		Artikelnummer part number	
(E) 	MB Axor I Blinker mit 24V Glühlampe <i>Indicator with bulb 24V</i>	◀ L R ▶	098 223 001 098 223 002
		Stecker / plug	
(E) 	MB Axor I Blinker mit Anschlusskabel und Stecker <i>Indicator with connection wire and plug</i>	◀ L R ▶	198 223 044 198 223 045
		Stecker / plug	
(E) + SM1 	MB Axor I Seitenmarkierungsleuchte mit Rückstrahler <i>Side marker lamp with reflex reflector</i>		098 221 225
			
	Anbauwinkel 90° / installation bracket 90°		098 293 309
	 Stecker / plug		099 110 006

(E) + SM1

LED

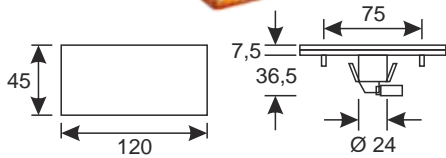

MB Axor I

Seitenmarkierungsleuchte
mit 6 LED und Rückstrahler, IP67

24V

Artikelnummer
part number

198 221 357

Side marker lamp, with 6 LED and reflex reflector, IP67

Stecker / plug

099 111 116



Seitenmarkierungsleuchte

mit 6 LED und Rückstrahler, Anschlusskabel 500mm, IP67

24V

098 221 357

Side marker lamp 24V

with 6 LED and reflex reflector, IP 67, connection cable 500mm

(E)

H1 H7



MB Axor II

Hauptscheinwerfer / Head lamp



098 150 021

098 150 022



099 111 116

099 110 620

Stecker / Plug

099 111 116

099 110 620

(E)

H1



Axor II

Nebelscheinwerfer / fog lamp







198 153 066

198 153 166



Stecker / plug

099 111 116

	MB Axor II Blinker / indicator	 	Artikelnummer part number
			098 223 046 098 223 047
	Stecker / plug Stecker / plug		099 111 116
			099 110 620

	MB Axor II Blinker / indicator	 	098 223 013
			099 110 469 099 110 743
	Stecker / plug Stecker / plug		099 110 469 099 110 743
			099 110 469 099 110 743

	MB Axor II Seitenmarkierungsleuchte mit Rückstrahler	24V	098 221 220	
			<i>Side marker lamp with reflex reflector</i>	
				098 291 358
				098 291 357
	Anbauwinkel 90° / installation bracket 90°		098 293 309	
	Stecker / plug		099 110 010	
				

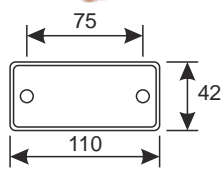

(E) + SM1

LED

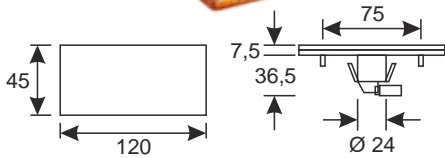

MB Axor I

Seitenmarkierungsleuchte
mit 6 LED und Rückstrahler, IP67

24V

Artikelnummer
part number

198 221 357

Side marker lamp, with 6 LED and reflex reflector, IP67

Stecker / plug

099 111 116

(E) + SM1



Seitenmarkierungsleuchte

mit 6 LED und Rückstrahler, Anschlusskabel 500mm, IP67

24V

098 221 357

Side marker lamp 24V

with 6 LED and reflex reflector, IP 67, connection cable 500mm

(E)

H4



MB Atego I

Hauptscheinwerfer mit Positionsleuchte
Head lamp with position lamp

L

R

098 076 113

098 076 114

Hauptscheinwerfer mit Positionsleuchte und Leuchtweitenregulierung

Head lamp with position lamp and levelling device

L

R

198 076 313

198 076 314

Streuscheibe / lens

L

R

098 109 836

098 109 837

Stecker / plug

099 110 620

(E)

H1

H4



MB Atego I

Hauptscheinwerfer mit Positionsleuchte und Nebelscheinwerfer

Head lamp with position lamp and fog lamp

L

R

098 076 123

098 076 124

Hauptscheinwerfer mit Positionsleuchte, Nebelscheinwerfer und Leuchtweitenregulierung

Head lamp with position lamp, fog lamp and levelling device

L

R

198 076 323

198 076 324

Streuscheibe / lens

L

R

098 109 836

098 109 837

Stecker / plug

099 110 620

Ⓔ



MB Atego I
Positionsluchte vorne
position lamp, front



Artikelnummer
part number

098 230 020

098 230 030

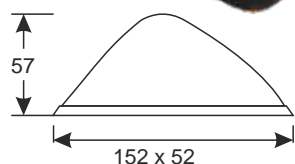

Ⓔ



MB Atego I
Blinker mit 24V Glühlampe
Indicator with bulb 24V



098 223 001

098 223 002



Stecker / plug

099 110 010

Ⓔ



MB Atego I
Blinker / indicator



298 223 042

298 223 043



Stecker / plug

099 110 010

Ⓔ + SM1

LED



MB Atego I
Seitenmarkierungsleuchte
mit 6 LED und Rückstrahler, IP67

24V

198 221 357

Side marker lamp, with 6 LED and reflex reflector, IP67

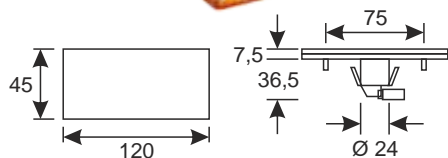

Stecker / plug

099 111 116

Ⓔ + SM1



Seitenmarkierungsleuchte
mit 6 LED und Rückstrahler, Anschlusskabel 500mm,
IP67

24V

098 221 357

*Side marker lamp 24V
with 6 LED and reflex reflector, IP 67, connection
cable 500mm*

Ⓔ

H1 H7



MB Atego II

Hauptscheinwerfer mit Positionsleuchte
Head lamp with position lamp



Artikelnummer
part number

098 076 200
098 076 201

Hauptscheinwerfer mit Positionsleuchte
und Leuchtweitenregulierung
Head lamp with position lamp and levelling device



098 076 210
098 076 211

Streuscheibe / lens



098 109 840
098 109 841

Stecker / plug

099 110 620

Ⓔ

H1 H7



MB Atego II

Hauptscheinwerfer mit Positionsleuchte
und Nebelscheinwerfer
Head lamp with position lamp and fog lamp



098 076 220
098 076 221

Hauptscheinwerfer mit Positionsleuchte,
Nebelscheinwerfer und Leuchtweiten-
regulierung
*Head lamp with position lamp, fog lamp and
levelling device*



098 076 230
098 076 231

Streuscheibe / lens



098 109 840
098 109 841

Stecker / plug

099 110 620

Ⓔ

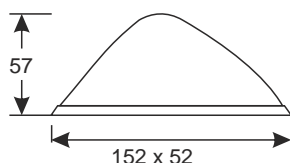









MB Atego II

Positionsleuchte vorne
position lamp, front

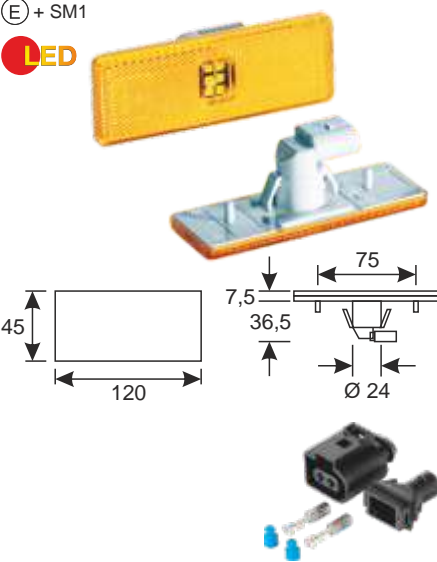
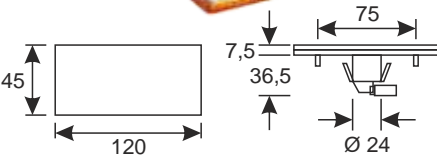

098 230 020
098 230 030

		Artikelnummer part number	
	MB Atego II Blinker / indicator		098 222 230 098 222 231
	Stecker / plug		099 111 116
	MB Atego II Blinker / indicator		098 223 013
	Stecker / plug Stecker / plug		099 110 469 099 110 743
	MB Atego II Blinker / indicator		298 223 042 298 223 043
	Stecker / plug		099 110 010
 	MB Atego II Seitenmarkierungsleuchte mit 6 LED und Rückstrahler, IP67	24V	198 221 357
	Stecker / plug		099 111 116
	Seitenmarkierungsleuchte mit 6 LED und Rückstrahler, Anschlusskabel 500mm, IP67	24V	098 221 357
	Side marker lamp 24V with 6 LED and reflex reflector, IP 67, connection cable 500mm		

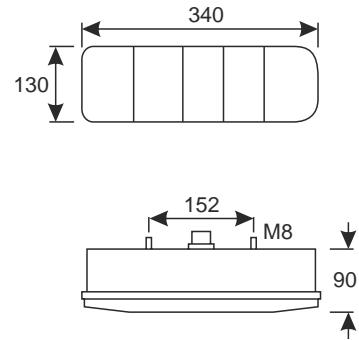
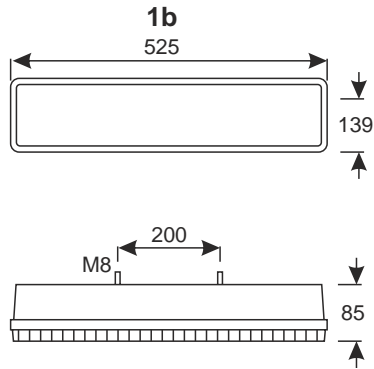
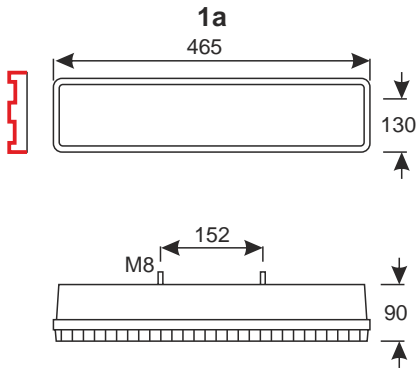
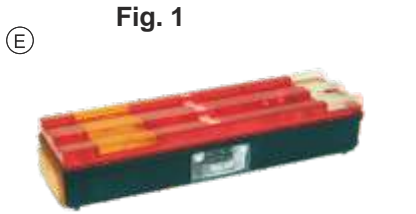

B



6 pol



099 110 629

Cs



6 pol



099 111 493

Ds



5 pol



099 111 493

Es



7 pol



099 111 493

Fs



HDS CS



099 110 152

Cs, Ds, Es, Fs =

Anschlussstecker seitlich / connector lateral

MB	Bezeichnung Name	Lichtscheibe / lens	Fig. Nr.	Links / left	Rechts / right	Blinker, Heck- und Brems- leuchte / indicator, tail- and stop lamp	2. Heckleuchte / tail lamp	Rückfahrleuchte / Reverse lamp	Nebelschlussleuchte Rear fog lamp	Positionslleuchte hinten Tail position lamp	Seitenmarkierungsleuchte side marker lamp	Kennzeichenbeleuchtung Numberplate lamp	Rückstrahler Reflex reflector	Anschluss / connector	Vergleichsnummer comparison number	Artikelnummer part number	
	Atego I, II	098 293 363	1a	●		●	●	●	●	●	●	●	●	B	003 544 53 03	098 213 381	
	Atego I, II	098 293 363	1a		●	●	●	●	●	●	●		●	B	003 544 52 03	098 213 391	
	Atego I, II	098 293 182	2	●		●	●	●	●		●	●	●	B	002 544 68 03	098 213 180	
	Atego I, II	098 293 182	2		●	●	●	●	●		●	●	●	B	002 544 69 03	098 213 190	
	Actros + Axor	098 293 323	1b	●		●	●	●	●	●	●	●	●	Cs	001 540 62 70	098 213 346	
	Actros + Axor	098 293 333	1b		●	●	●	●	●	●	●		●	Ds	001 540 63 70	098 213 356	
	Actros + Axor	098 293 323	1b	●		●	●	●	●	●	●	●	●	Es	001 540 62 70	098 213 366	
	AMP Stecker / AMP plug connector															098 213 346 / 356 / 366	099 111 493
	AMP Stecker / AMP plug connector															098 213 180 / 190 / 381 / 391	099 110 629
	HDS CS Stecker / plug connector																099 110 152

Ⓔ

Fig. 1



388 x 190 mm

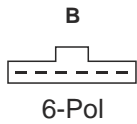

Ⓔ

Fig. 2



388 x 190 mm

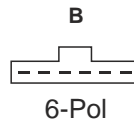

Ⓔ

Fig. 3



Bezeichnung Name	Fig. Nr.	Links / left	Rechts / right	Blinker, Heck- und Brems- leuchte / indicator, tail- and stop lamp	2. Heckleuchte / tail lamp	Rückfahrcheinwerfer Reverse lamp	Nebelschlussleuchte Rear fog lamp				Rückstrahler Reflex reflector	Anschluss / connector	Vergleichsnummer comparison number	Artikelnummer part number
MB Sprinter 02/1995 >	1	●		●		●	●					B		098 213 031
MB Sprinter 02/1995 >	1		●	●		●	●					B		098 213 032
MB Sprinter 02/1995 >	1	●		●		●	●					B		098 213 035*
MB Sprinter 02/1995 >	1		●	●		●	●					B		098 213 036*
MB Sprinter 2003 >	2	●		●		●	●					B		098 213 041
MB Sprinter 2003 >	2		●	●		●	●					B		098 213 042
MB Sprinter 2003 >	2	●		●		●	●					B		098 213 043*
MB Sprinter 2003 >	2		●	●		●	●					B		098 213 044*
MB Sprinter 2006 >	3	●		●		●	●						9068200264	198 213 051
MB Sprinter 2006 >	3		●	●		●	●						9068200164	198 213 050

*) nur Lichtgehäuse ohne Lampenträger
only housing without bulb holder

Artikelnummer
part number



MB Sprinter, VW Crafter 04/2006 >
Heckleuchte



098 212 893

mit Bremsleuchte, Blinker, Nebelschlussleuchte,
Rückfahrscheinwerfer, Seitenmarkierungsleuchte,
Kennzeichenbeleuchtung, AMP Anschluss hinten
Tail lamp

*with stop lamp, indicator, rear fog lamp, reverse lamp,
side marker lamp, with numberplate lamp, AMP
connector backside*

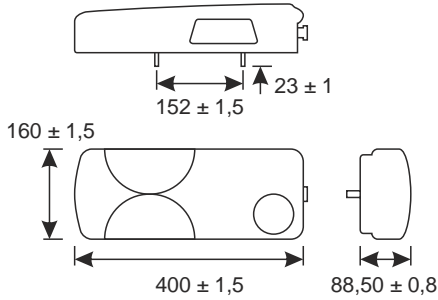

Heckleuchte



098 212 894

mit Bremsleuchte, Blinker, Nebelschlussleuchte,
Rückfahrscheinwerfer, Seitenmarkierungsleuchte,
AMP Anschluss hinten
Tail lamp

*with stop lamp, indicator, rear fog lamp, reverse lamp,
side marker lamp, AMP connector backside*

Lichtscheibe / lens



098 292 896





098 292 897



Stecker AMP 1,5 7-polig, 90°, 5mm
plug AMP 1,5 7-pole 90°, 5mm

099 111 485

		Artikelnummer part number	
(E) H1 H1 	RVI Premium I / Kerax Hauptscheinwerfer mit Positionsleuchte und Blinker <i>Head lamp with position lamp and indicator</i>		L R 098 106 976 098 106 977
	Blinker / indicator		L R 098 222 400 098 222 410
(E) H1 H1 	RVI Kerax Hauptscheinwerfer mit Positionsleuchte <i>Head lamp with position lamp</i>		L R 198 106 975 198 106 974
	(E) H1 H1 	RVI Premium I Fernscheinwerfer mit Nebelscheinwerfer <i>High beam with fog lamp</i>	
 Stecker / plug		099 110 006	
(E) 	RVI Premium I / Kerax Positionsleuchte vorne / <i>Position lamp, front</i>		098 230 010
			
(E) 	RVI Premium I / Kerax Blinker / indicator		L R 098 222 400 098 222 410
	(E) 	RVI Premium I / Kerax Blinker / indicator	
 Fassung / bulb holder		Ba15s 098 291 510	
 Stecker / plug		099 110 378	

		Artikelnummer part number	
	RVI Premium I / Kerax Blinker / indicator		910 221 836
	Fassung / bulb holder	Ba15s	098 291 510
		Stecker / plug	

	RVI Premium II Hauptscheinwerfer mit Nebelscheinwerfer, Blinker und Positionsleuchte, Chrom Head lamp with fog lamp, indicator and position lamp, chrome		198 083 001 198 083 002
	H1 H7 H3		

	Hauptscheinwerfer Xenon mit Blinker, Positionsleuchte und Nebelscheinwerfer, Chrom Head lamp HID with indicator, position lamp and fog lamp, chrome		198 083 007 198 083 008
	XENON D1S H1		
Streuscheibe / lens			098 109 708 098 109 709

	RVI Premium I. II / Kerax Seitenmarkierungsleuchte 24V 3W mit Rückstrahler und 2-poligem AMP Anschluss Side marker lamp with reflex reflector and 2-pole AMP connector		098 221 381
	E + SM1		

	RVI Eco Seitenmarkierungsleuchte 24V 3W mit Rückstrahler und 2-poligem AMP Anschluss Side marker lamp with reflex reflector and 2-pole AMP connector		198 221 381
	84 50 18 110 22		

Fassung / bulb holder			098 291 381
	Stecker / plug		099 110 741

Artikelnummer
part number

Ⓔ

H4



RVI Magnum AE

Hauptscheinwerfer mit Positionsleuchte
Head lamp with position lamp



098 069 715

Hauptscheinwerfer ohne Positionsleuchte
Head lamp without position lamp



098 069 716

Ⓔ

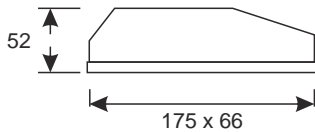

RVI Magnum AE

Positionsleuchte vorne / *Position lamp, front*

098 242 820

Ⓔ



RVI Magnum AE

Blinker / *indicator*



098 221 838

Fassung / *bulb holder*

Ba15s



098 291 510

Stecker / *plug*

099 110 378

Ⓔ

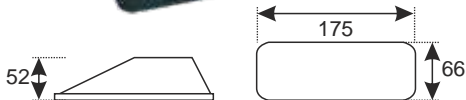

RVI Magnum AE > 12/98

Blinker / *indicator*



098 236 827

Ⓔ



RVI Magnum AE 12/98 >

Blinker / *indicator*



098 236 829

Ⓔ + SM1



Premium

RVI Magnum AE

Seitenmarkierungsleuchte

24V 3W

Artikelnummer
part number

098 221 381

mit Rückstrahler und 2-poligem AMP Anschluss

Side marker lamp

with reflex reflector and 2-pole AMP connector

Eco

Seitenmarkierungsleuchte

24V 3W

198 221 381

mit Rückstrahler und 2-poligem AMP Anschluss

Side marker lamp with reflex reflector and 2-pole

AMP connector

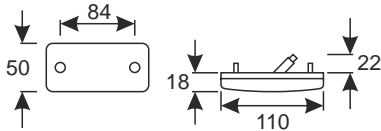

Fassung / bulb holder

098 291 381



Stecker / plug

099 110 741

Ⓔ

H1 H7



RVI Magnum E-Tech

Hauptscheinwerfer mit Nebel-
scheinwerfer und Positionsleuchte

◀ L ▶ R

098 083 005

098 083 006

Head lamp with fog lamp and position lamp

Streuscheibe / lens

◀ L ▶ R

098 109 704

098 109 705

Ⓔ

H1



RVI Magnum E-Tech

Nebelscheinwerfer / fog lamp

◀ L ▶ R

098 089 190

Stecker / plug

099 110 006

Ⓔ



RVI Magnum E-Tech

Positionsleuchte vorne / **Position lamp, front**

098 242 820

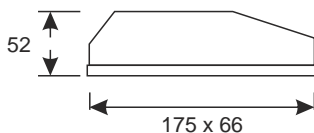

Ⓔ



RVI Magnum E-Tech

Blinker / **indicator**

◀ L ▶ R

098 236 829



Ⓔ

H1 H1



RVI Midlum
Hauptscheinwerfer mit Positionsleuchte
Head lamp with position lamp



Artikelnummer
part number

098 089 291
098 089 290

Ⓔ

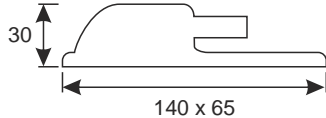

RVI Midlum
Positionsleuchte vorne / *Position lamp, front*

098 230 010

Ⓔ



RVI Midlum
Blinker / *indicator*



098 222 400
098 222 410

Ⓔ + SM1



Premium

RVI Magnum E-Tech / Midlum
Seitenmarkierungsleuchte 24V 3W
mit Rückstrahler und 2-poligem AMP Anschluss
Side marker lamp
with reflex reflector and 2-pole AMP connector

098 221 381

Eco

Seitenmarkierungsleuchte 24V 3W
mit Rückstrahler und 2-poligem AMP Anschluss
Side marker lamp with reflex reflector and 2-pole AMP connector

198 221 381

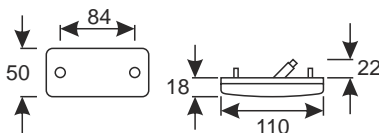

Fassung / bulb holder
Stecker / plug

098 291 381
099 110 741

Ⓔ



RVI Magnum Midlum
Kennzeichenbeleuchtung 12/24V Ba15s
mit Flachsteckanschluss 6,3mm
Numberplate lamp with flat plug connection 6,3mm

098 254 096

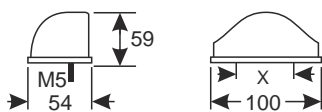

x = 45 / 72 / 75mm



Stecker / plug

099 110 386

Fig. 1

Ⓔ

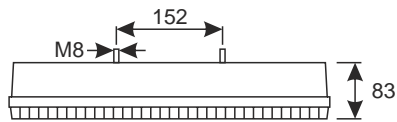
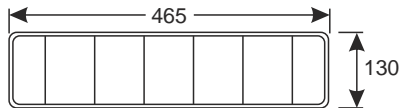
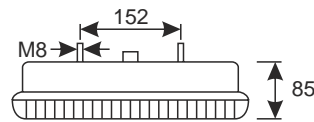
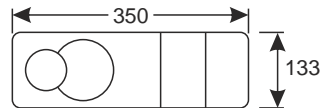

Fig. 2

Ⓔ



Bs



6 pol AMP



099 111 493

C



6 pol AMP



099 111 493

Bs = 
Anschlussstecker seitlich
connector lateral

Bezeichnung Name	Lichtscheibe / lens	Fig. Nr.	Links / left	Rechts / right	Blinker, Heck- und Brems- leuchte / indicator, tail- and stop lamp	2. Heckleuchte / tail lamp	Rückfahrleuchte Reverse lamp	Nebelschlussleuchte Rear fog lamp	Positionslampe hinten Tail position lamp	Seitenmarkierungsleuchte side marker lamp	Kennzeichenbeleuchtung Numberplate lamp	Rückstrahler Reflex reflector	Anschluss / connector	Vergleichsnummer comparison number	Artikelnummer part number
RVI R.V.I. Magnum, Premium, Xerax, Midlum		098 292 793	1	●	●	●	●	●	●	●		●	Bs	500 186 4536	098 212 956
RVI		098 292 793	1	●	●	●	●	●	●	●	●	●	Bs	500 186 4535	098 212 957
RVI		098 292 919	2	●	●	●	●	●				●	C	500 185 8092	098 212 912
RVI		098 292 919	2	●	●	●	●	●			●	●	C	500 184 6847	098 212 910
AMP Stecker / AMP plug connector															099 111 493
Lichtscheibe Seitenmarkierungsleuchte und Rückstrahler lens for side marker lamp and reflex reflector															098 212 956 / 957
															098 292 959



Fig. 1

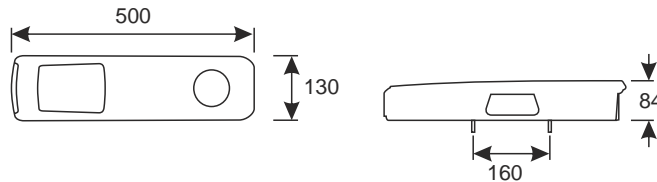

As



7 pol



099 111 493







099 110 619

As =

Anschlussstecker seitlich
connector lateral

Bezeichnung Name	Lichtscheibe / lens	Fig. Nr.	Links / left	Rechts / right	Blinker, Heck- und Brems- leuchte / indicator, tail- and stop lamp	2. Heckleuchte / tail lamp	Rückfahrwarnleuchte Reverse lamp	Nebelschlussleuchte Rear fog lamp	Rückfahrwarner backup alarm	Seitenmarkierungsleuchte side marker lamp	Kennzeichenbeleuchtung Numberplate lamp	Rückstrahler Reflex reflector	Anschluss / connector	Vergleichsnummer comparison number	Artikelnummer part number
RVI	098 292 903	1	●		●	●		●		●		●	As	742 080 2348	098 212 900
RVI	098 292 903	1		●	●	●		●		●	●	●	As	742 080 2350	098 212 901
RVI	098 292 903	1		●	●	●	●		●	●		●	As	742 080 2353	098 212 902*
AMP Stecker 90° / AMP plug 90°															099 111 493
AMP Stecker 180° / AMP plug 180°															099 110 619

* = mit Rückfahrwarner / with backup alarm

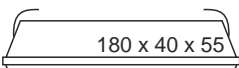
		Artikelnummer part number			
(E) H4		Scania 4, P / G / R / T 04 - 08 Hauptscheinwerfer mit Blink-, Positionsleuchte und Anschlußkabel <i>Head lamp with indicator, position lamp and connection wire</i>			
		◀ L R ▶	198 103 110 198 103 120		
		<hr/> Streuscheibe / lens		◀ L R ▶	098 109 965 098 109 966
		<hr/> Anschlusskabel / connection wire		◀ L R ▶	098 109 969
(E) H3		Scania 4 96 > Nebel- und Fernscheinwerfer <i>Fog lamp and high beam</i>			
		◀ L R ▶	098 148 991 098 148 992		
(E) H1		Scania P / G / R / T 04 > Fernscheinwerfer / high beam			
		◀ L R ▶	098 055 202 098 055 203		
		<hr/> Stecker / plug		099 110 006	
(E) H1		Scania P / G / R / T 04 > Nebelscheinwerfer / fog lamp			
		◀ L R ▶	098 055 204 098 055 205		
		<hr/> Stecker / plug		099 110 006	
(E) LED	 	SCANIA P / G / R / T 04 > Einbau-Positionsleuchte vorne, 4 LED 24V mit 2-poligem Flachsteckanschluss <i>Position lamp built in, front, 4 LED with 2-pole flat plug connector</i>			
		<hr/> Stecker / plug		099 110 636	

Ⓔ



Scania 4, P / G / R / T 04 - 08
Blinker / indicator



Artikelnummer
part number

098 293 014
098 293 015



Anschlusskabel / connection wire



098 109 969

Ⓔ + SM1



Scania 4, P / G / R / T 04 - 08
Seitenmarkierungsleuchte
mit Rückstrahler und AMP Anschluss, IP67

098 221 377

Side marker lamp
with reflex reflector and AMP connection, IP67

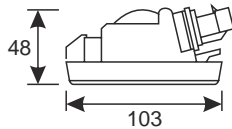

Fassung mit AMP Stecker
bulb holder with AMP connector

098 291 378



Stecker / plug

099 110 019

Ⓔ + SM1

LED



Scania 4
Seitenmarkierungsleuchte
mit 4 LED und 1.500mm Kabel

24V

098 221 245

Side marker lamp 4 LED with 1.500mm cable

Ⓔ + SM1

LED

Premium



Scania Serie 4, P / G / R / T 04 >
Seitenmarkierungsleuchte LED,
mit Rückstrahler und AMP Anschluss, IP67
*Side marker lamp LED, with reflex reflector and
AMP connection, IP67*

24V

298 221 230

Anschlusskabel / connection cable

098 291 235



Stecker / plug

099 110 636

Ⓔ

H7 H7



Scania P / G / R 08 >
Hauptscheinwerfer mit Positionsleuchte
Head lamp with position lamp

◀ L
 R ▶

Artikelnummer
 part number
198 103 150
198 103 160

D2R H7

XENON

Hauptscheinwerfer XENON mit
 Positionsleuchte
Head lamp HID with position lamp

◀ L
 R ▶

198 103 130
198 103 140

Streuscheibe / lens

◀ L
 R ▶

098 109 980
098 109 981

Ⓔ

H1



Scania P / G / R 08 >
Fernscheinwerfer / high beam

◀ L
 R ▶

098 055 202
098 055 203



Stecker / plug

099 110 006

Ⓔ

H1



Scania P / G / R 08 >
Nebelscheinwerfer / fog lamp

◀ L
 R ▶

098 055 204
098 055 205



Stecker / plug

099 110 006

Ⓔ

LED



Scania P / G / R 08 >
Tagfahrleuchte 9-33V
 Sehr helle LED der letzten Generation,
 ECE geprüft, IP67

◀ L
 R ▶

098 055 613
098 055 614

Daytime running light
 New generation super bright LED's, ECE approved,
 IP67



Stecker / plug

099 110 019

		Artikelnummer part number	
<p>Ⓔ</p> <p>LED</p>   	<p>Scania P / G / R 08 > Einbau-Positionsleuchte vorne, 4 LED 24V mit 2-poligem Flachsteckanschluss <i>Position lamp built in, front, 4 LED</i> with 2-pole flat plug connector</p>		<p>098 230 610</p>
		<p>Stecker / plug</p>	<p>099 110 636</p>
<p>Ⓔ</p>  	<p>Scania P, G, R 08 > Blinker / indicator</p>	<p>◀ L R</p>	<p>098 223 070</p>
		<p>Stecker / plug</p>	<p>099 110 636</p>
<p>Ⓔ</p> 	<p>Scania P, G, R 08 > Blinker / indicator</p>	<p>◀ L R</p>	<p>098 223 075</p>
<p>Ⓔ + SM1</p>   	<p>Scania P / G / R 08 > Seitenmarkierungsleuchte mit Rückstrahler und AMP Anschluss, IP67 <i>Side marker lamp</i> with reflex reflector and AMP connection, IP67</p>		<p>098 221 377</p>
		<p>Fassung mit AMP Stecker <i>bulb holder with AMP connector</i></p>	<p>098 291 378</p>
		<p>Stecker / plug</p>	<p>099 110 019</p>

Ⓔ + SM1

LED



Scania P / G / R 08 >

Seitenmarkierungsleuchte
mit 4 LED und 1.500mm Kabel

24V

Artikelnummer
part number

098 221 245

Side marker lamp 4 LED with 1.500mm cable

Ⓔ + SM1

LED



Premium

Scania P / G / R 08 >

Seitenmarkierungsleuchte LED,
mit Rückstrahler und AMP Anschluss, IP67
*Side marker lamp LED, with reflex reflector and
AMP connection, IP67*

24V

298 221 230

Anschlusskabel / connection cable

098 291 235

Stecker / plug

099 110 636



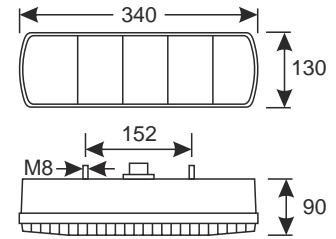
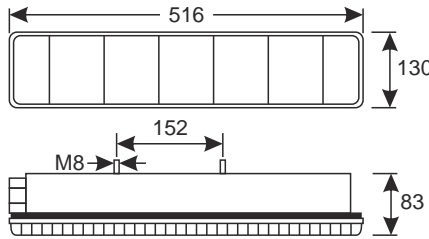
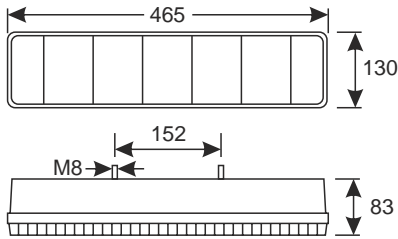
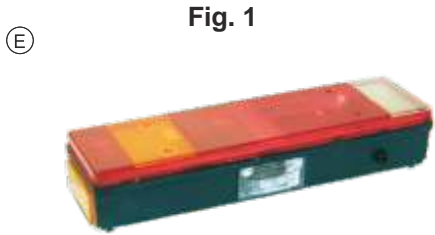

A



Cs



6 pol

Ds



6 pol



099 111 481



099 111 481

Cs, Ds =
 Anslusstecker seitlich
 connector lateral

SCANIA	Bezeichnung Name	Lichtscheibe / lens	Fig. Nr.	Links / left	Rechts / right	Blinker Heck- und Brems- leuchte / indicator, tail- and stop lamp	2. Heckleuchte / tail lamp	Rückfahrcheinwerfer Reverse lamp	Nebelschlussleuchte Rear fog lamp	Positionslampe hinten Tail position lamp	Seitenmarkierungsleuchte side marker lamp	Kennzeichenbeleuchtung Numberplate lamp	Rückstrahler Reflex reflector	Anschluss / connector	Vergleichsnummer comparison number	Artikelnummer part number
Scania 3 >1996	098 292 793	1	●		●	●	●	●	●	●	●	●	●	A	1 365 963	098 212 963
Scania 3 >1996	098 292 793	1		●	●	●	●	●	●	●	●		●	A	1 365 964	098 212 964
Scania 4 1996>	098 293 163	2	●		●	●	●	●	●	●	●	●	●	A	1 436 867	098 213 161
Scania 4 1996>	098 293 163	2		●	●	●	●	●	●	●	●		●	A	1 371 975	098 213 171
Scania P/G/RT	098 293 163	2		●	●	●	●	●	●	●	●		●	Cs	1 498 103	098 213 162
Scania P/G/RT	098 293 163	2	●		●	●	●	●	●	●	●	●	●	Cs	1 498 102	098 213 163
Scania P/G/RT	098 293 163	2		●	●	●	●	●	●	●	●		●	Ds	1 792 374	098 213 167
Scania P/G/RT	098 293 163	2	●		●	●	●	●	●	●	●	●	●	Ds	1 792 375	098 213 168
Scania P/G/RT	098 293 223	3	●	●	●	●	●				●		●	A	1 409 253	098 213 220
Scania P/G/RT	098 293 223	3	●		●	●	●	●	●	●	●		●	A	1 409 252	098 213 230
AMP Stecker / AMP plug connector						098 213 162 / 163 / 167 / 168								099 111 481		
Lichtscheibe für Rückstrahler und Seitenmarkierungsleuchte lens for reflex reflector and side marker lamp						098 212 963 / 964								098 292 959		

Fig. 1

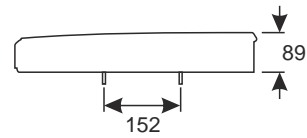
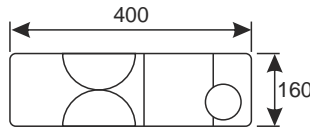

As



As =

Anschlussstecker seitlich
connector lateral



099 111 648

SCANIA														
Bezeichnung Name	Lichtscheibe / lens	Fig. Nr.	Links / left	Rechts / right	Blinker, Heck- und Brems- leuchte / indicator, tail- and stop lamp	2. Heckleuchte / tail lamp	Rückfahrwarnleuchte Reverse lamp	Nebelschlussleuchte Rear fog lamp	Rückfahwarner backup alarm	Seitenmarkierungsleuchte side marker lamp	Kennzeichenbeleuchtung Numberplate lamp	Rückstrahler Reflex reflector	Vergleichsnummer comparison number	Artikelnummer part number
P/G/R 08>	098 292 896	1	●		●	●	●	●		●		●	1 756 754	098 212 895
P/G/R 08>	098 292 897	1		●	●	●	●	●		●		●	1 756 751	098 212 896
P/G/R 08>	098 292 897	1		●	●	●	●	●		●		●	1 791 369	098 212 897
Rückfahwarner / backup alarm													099 450 995	
Stecker AMP 1,5 / plug connector AMP 1,5													099 111 648	

E

LED



Heckleuchte Scania P/G/R 08 >

Auch einsetzbar für / also useable for DAF, MAN, Renault

Betriebsdauer der LED: ca. 30.000 Stunden
Operating time LED: ca. 30.000 hours

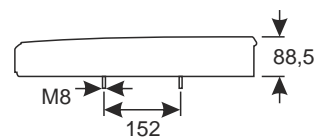
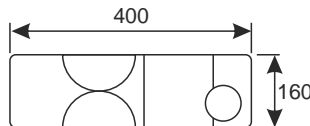

As



As =

Anschlussstecker seitlich
connector lateral



099 111 648

SCANIA															
Bezeichnung Name	Lichtscheibe / lens	Fig. Nr.	Links / left	Rechts / right	Blinker, Heck- und Brems- leuchte / indicator, tail- and stop lamp	2. Heckleuchte / tail lamp	Rückfahrwarnleuchte Reverse lamp	Nebelschlussleuchte Rear fog lamp	Rückfahwarner backup alarm	Seitenmarkierungsleuchte side marker lamp	Kennzeichenbeleuchtung Numberplate lamp	Rückstrahler Reflex reflector	AMP Stecker / plug	Vergleichsnummer comparison number	Artikelnummer part number
P/G/R 08 >	098 292 895	1	●		●	●	●	●		●		●	●		098 215 890
P/G/R 08 >	098 292 895	1		●	●	●	●	●		●		●	●		098 215 891
Vorschaltgerät / converter													098 400 020		
Stecker AMP 1,5 / plug connector AMP 1,5													099 111 648		

Artikelnummer
part number

Ⓔ

H4



Volvo F / FL / FS 10, 12, 16
Hauptscheinwerfer / *head lamp*



098 103 315

Ⓔ



Volvo F, FL, FS 10, 12, 16
Blinker mit Positionsleuchte vorne,
Flachsteckanschluß 6,3mm
*Indicator with position lamp, front, with flat plug
connector 6,3mm*



098 223 056
098 223 055

Ⓔ + SM1



Volvo F / FL / FS 10, 12, 16
Seitenmarkierungsleuchte
mit Rückstrahler und AMP Anschluss, IP67

24V

098 221 377

*Side marker lamp
with reflex reflector and AMP connection, IP67*

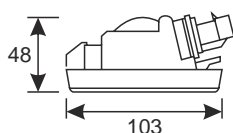

Fassung mit AMP Stecker
bulb holder with AMP connector

098 291 378



Stecker / *plug*

099 110 019

Ⓔ

H1 H1



Volvo FL 00 - 05
Hauptscheinwerfer / *head lamp*



098 103 400
098 103 401

Ⓔ



Volvo FL 00 - 05
Lichtscheibe ohne Glühlampenfassung
lens without socket



098 293 018



Fassung / *bulb holder*

Ba15s

098 291 510



Stecker / *plug*

099 110 378

Ⓔ + SM1

LED

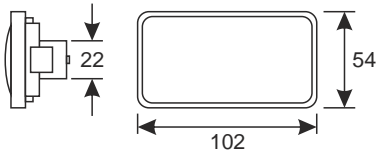

Volvo FL 00 - 05

Seitenbegrenzungsleuchte 4 LED

24V

Rückstrahler und AMP Anschluss, IP67

Side marker lamp 4 LED with reflex reflector and AMP connector, IP67

Artikelnummer
part number

098 221 265

Adapterkabel Upgrade auf LED
adapter for LED upgrade

098 291 266

Stecker / plug

099 110 635



Ⓔ

H4



Volvo FL II, FE II 06 >

Hauptscheinwerfer mit Positionsleuchte und Blinker

◀ L

098 082 010

Headlamp with position lamp and indicator lamp

▶ R

098 082 012

Ⓔ



Volvo FL II, FE II 06 >

Positionsleuchte vorne / Position lamp, front

098 230 010

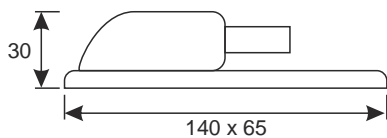

Ⓔ



Volvo FL II, FE II 06 >

Positionsleuchte vorne
Position lamp, front

098 231 381

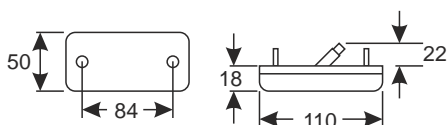

Fassung / bulb holder

098 291 381

Stecker / plug

099 110 006



Ⓔ

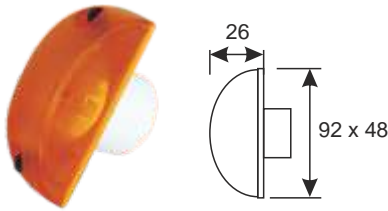

Volvo FL II, FE II 06 >
Blinker / indicator



Artikelnummer
part number

098 221 837



Fassung Ba15s AMP JPT3
socket Ba15s AMP JPT3

098 291 510



Stecker / plug

099 110 378

Ⓔ + SM1

Premium

Volvo FL II, FE II 06 >

Seitenmarkierungsleuchte 24V 3W
mit Rückstrahler und 2-poligem AMP Anschluss
Side marker lamp
with reflex reflector and 2-pole AMP connector

098 221 381



Eco

Seitenmarkierungsleuchte 24V 3W
mit Rückstrahler und 2-poligem AMP Anschluss
Side marker lamp with reflex reflector and 2-pole
AMP connector

198 221 381

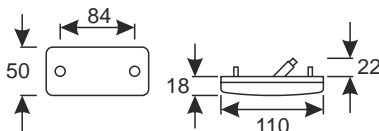

Fassung / bulb holder

098 291 381



Stecker / plug

099 110 006

Ⓔ



Volvo FL II, FE II 06 >

Kennzeichenbeleuchtung 12/24V Ba15s
mit Flachsteckanschluss 6,3mm
Numberplate lamp with flat plug connection 6,3mm



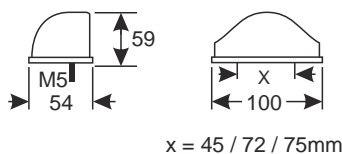







098 254 096

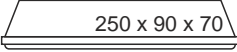

Stecker / plug

099 110 386



		Artikelnummer part number	
(E) H4		Volvo FH 93 - 97 Hauptscheinwerfer / <i>head lamp</i>	◀ L R ▶ 098 103 325
(E) H4		Volvo FH, FM, 97 - 01 Hauptscheinwerfer / <i>head lamp</i>	◀ L R ▶ 098 103 330
(E) H3	 098 153 334	Volvo FH, FM 93 - 01 Nebelscheinwerfer mit Positionsleuchte <i>Fog lamp with position lamp</i>	◀ L R ▶ 098 153 334 098 153 335
	 098 153 336	Nebelscheinwerfer mit Positionsleuchte Einbau mit „CLIP“ <i>Fog lamp with position lamp, installation with "CLIP"</i>	◀ L R ▶ 098 153 336 098 153 337
		Lampenfassung mit 2-poligem Stecker <i>Bulb holder with 2-pole connector</i>	098 299 972
(E)	 	Volvo FH, FM 93-01 Positionsleuchte vorne / <i>position lamp, front</i>	098 233 051
		Lampenfassung mit 2-poligem Stecker <i>Bulb holder with 2-pole connector</i>	098 299 972
(E)		Volvo FH, FM 93 - 01 Blinker mit Positionsleuchte vorne, inkl. Fassung <i>Indicator with position lamp, front, bulb holder included</i>	◀ L R ▶ 098 223 050
		Fassung / bulb holder	Ba15s 098 299 973

Ⓔ + SM1

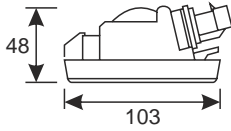

Volvo FH, FM 93 - 01
Seitenmarkierungsleuchte
 mit Rückstrahler und AMP Anschluss, IP67

24V

Artikelnummer
part number

098 221 377

Side marker lamp
 with reflex reflector and AMP connection, IP67

Fassung mit AMP Stecker
bulb holder with AMP connector

098 291 378

Stecker / plug

099 110 019

Ⓔ

H7



Eco

Volvo FM II, FH II 02 -08

Hauptscheinwerfer mit Positionsleuchte, Blinker, Fern- und Nebelscheinwerfer. Auch für Leuchtweitenregulierung verwendbar. Anschlussstecker eckig.

Head lamp with position lamp, indicator, driving lamp and fog lamp. Also levelling device used. Plug square.

L

R

Artikelnummer
part number

098 082 005

098 082 006

Ⓔ



Premium Line

Hauptscheinwerfer mit Positionsleuchte, Blinker, Fern- und Nebelscheinwerfer. Auch für Leuchtweitenregulierung verwendbar. Anschlussstecker eckig.

Head lamp with position lamp, indicator, driving lamp and fog lamp. Also levelling device used. Plug square.

L

R

298 082 005

298 082 006

Ⓔ

XENON

D2R



Hauptscheinwerfer Xenon mit Positionsleuchte, Blinker, Fern- und Nebelscheinwerfer. Auch für Leuchtweitenregulierung verwendbar. Anschlussstecker rund.

Head lamp HID with position lamp, indicator, driving lamp and fog lamp. Also levelling device used. Plug round.

L

R

298 082 003

298 082 004



Adapter von rund zu eckigem Stecker
Adapter from round to square plug

098 291 005



Streuscheibe / lens

L

R

098 110 001

098 110 002



Einbaurahmen / holder

L

R

098 110 003

098 110 004

		Artikelnummer part number	
(E)	 	Volvo FM II / FH II 02 > Positionslampe Glühlampe <i>position lamp with bulb</i>	24V 098 233 053

(E)		Volvo FM II / FH II 02 > Seitenblinker mit Gehäuse <i>side indicator with housing</i>	bestehend aus: 098 223 016 <i>consists of</i> 098 293 024 bestehend aus: 098 223 017 <i>consists of</i> 098 293 025	◀ L 098 223 022 ▶ R 098 223 023
-----	---	--	--	--

(E)		Seitenblinker ohne Gehäuse <i>side indicator without housing</i>	◀ L 098 223 016 ▶ R 098 223 017
-----	--	--	--

Gehäuse <i>housing</i>	◀ L 098 293 024 ▶ R 098 293 025
----------------------------------	--

(E) + SM1	 	Volvo FM II / FH II 02 > Seitenbegrenzungsleuchte 4 LED Rückstrahler und AMP Anschluss, IP67 Side marker lamp 4 LED with reflex reflector and AMP connector, IP67	24V 098 221 265
-----------	--	--	---------------------------

Adapterkabel Upgrade auf LED <i>adapter for LED upgrade</i>	098 291 266
---	--------------------

Stecker / plug	099 110 635
-----------------------	--------------------



(E) + SM1

LED

Premium

Volvo FM II / FH II 02 >

Seitenmarkierungsleuchte LED

24V

Artikelnummer
part number

298 221 230

mit Rückstrahler und AMP Anschluss, IP67

Side marker lamp LED, with reflex reflector and AMP connection, IP67



Anschlusskabel / connection cable

098 291 235

Stecker / plug

099 110 636

(E)

LED

H7

Premium

Volvo FM III, FH III 08 >

Hauptscheinwerfer mit Tagfahrlicht LED

L

298 082 007

Headlamp with daytime running light LED

R

298 082 008



XENON

LED

D2S

H7

Hauptscheinwerfer Xenon, verchromt

298 082 009

mit Tagfahrlicht LED

298 082 011

Headlamp HID, chromed

with daytime running light LED



XENON

LED

D2S

H7

Hauptscheinwerfer Xenon, schwarz

L

298 082 021

mit Tagfahrlicht LED

R

298 082 020

Headlamp HID, black

with daytime running light LED

Streuscheibe / lens

L

098 110 005

R

098 110 006

(E)

H3

Volvo FM III, FH III 08 >

Nebelscheinwerfer

L

098 153 001

Ausführung Chrom, Einzelscheinwerfer

R

098 153 002

mit einem Projektionscheinwerfer

Fog lamp, chrome finish, single lamp with one projection lamp



(E)

H3

H3

Premium

Volvo FM III, FH III 08 >

Nebelscheinwerfer

L

298 153 003

Ausführung Chrom, Doppelscheinwerfer

R

298 153 004

mit einem Projektions- und einem Reflektorscheinwerfer

Fog lamp

chrome finish, double lamp with one projection- and one reflectorlamp



		Artikelnummer part number		
(E)	<div style="display: flex; justify-content: space-around;"> H3 H3 </div>	<p style="color: #f06292; font-weight: bold; font-size: small;">Premium Line</p> <p>Volvo FM III, FH III 08 > Nebelscheinwerfer Ausführung Chrom, mit schwarzem Rahmen, Doppelscheinwerfer mit einem Projektions- und einem Reflektorscheinwerfer</p> <p>Fog lamp H3 <i>chrome finish with black frame, double lamp with one projection- and one reflectorlamp</i></p>	<div style="display: flex; justify-content: space-around; font-size: x-small;"> L R </div>	<p>298 153 005 298 153 006</p>
(E)	<div style="display: flex; justify-content: space-around;"> H3 H7 </div>	<p style="color: #f06292; font-weight: bold; font-size: small;">Premium Line</p> <p>Volvo FH16 08 > Nebelscheinwerfer Ausführung schwarz, Doppelscheinwerfer mit einem Projektionsscheinwerfer und einem Kurvenlicht</p> <p>Fog lamp <i>black finish, double lamp with one projection- and one curve light</i></p>	<div style="display: flex; justify-content: space-around; font-size: x-small;"> L R </div>	<p>298 153 007 298 153 008</p>
(E)		<p>Volvo FM III, FH III 08 > Positionsleuchte Glühlampe <i>position lamp bulb</i></p>	<p>24V</p>	<p>098 233 053</p>
(E)	<div style="display: flex; justify-content: space-around;"> LED </div> 	<p>Volvo FH III, FM III 08 > Blinker / indicator</p> <hr/> <p>Blinkergehäuse / indicator housing</p> <hr/> <p>Stecker / plug</p>	<div style="display: flex; justify-content: space-around; font-size: x-small;"> L R </div>	<p>098 223 020 098 223 021</p> <hr/> <p>098 293 022 098 293 023</p> <hr/> <p>099 110 635</p>
(E) + SM1	<div style="display: flex; justify-content: space-around;"> LED </div> 	<p>Volvo FH III, FM III 08 > Seitenbegrenzungsleuchte 4 LED Rückstrahler und AMP Anschluss, IP67 Side marker lamp 4 LED with reflex reflector and AMP connector, IP67</p>	<p>24V</p>	<p>098 221 265</p> <hr/> <p>Adapterkabel Upgrade auf LED adapter for LED upgrade</p> <hr/> <p>Stecker / plug</p>

E + SM1

LED

*Premium Line*

Volvo FH III, FM III 08 >
Seitenmarkierungsleuchte LED, 24V
 mit Rückstrahler und AMP Anschluss, IP67
Side marker lamp LED, with reflex reflector and
AMP connection, IP67

 Artikelnummer
 part number

298 221 230

Anschlusskabel / connection cable

098 291 235



Stecker / plug

099 110 636

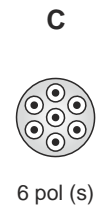
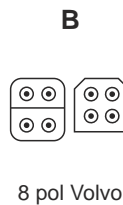
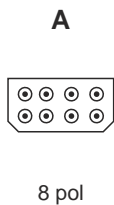
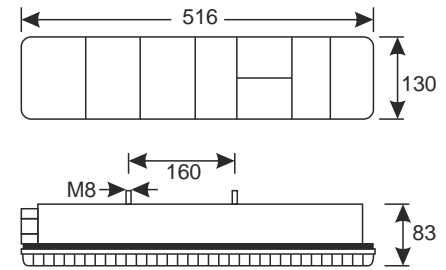
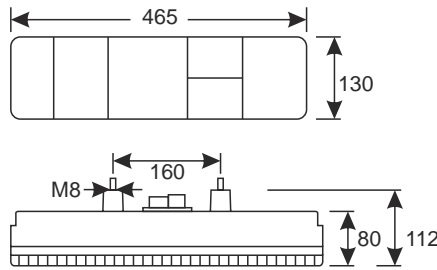
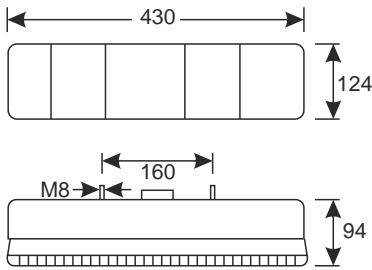
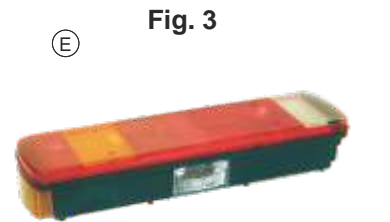
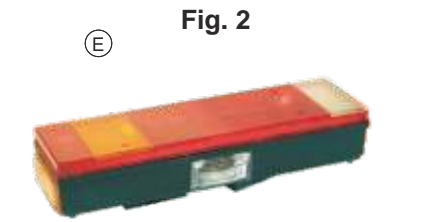

099 111 493

Cs =
Anschlussstecker seitlich
connector lateral

Bezeichnung Name	Lichtscheibe / lens	Fig. Nr.	Links / left	Rechts / right	Blinker, Heck- und Brems- leuchte / indicator, tail- and stop lamp	2. Heckleuchte / tail lamp	Rückfahrseinwerfer Reverse lamp	Nebelschlussleuchte Rear fog lamp	Positionslampe hinten Tail position lamp	Seitenmarkierungsleuchte side marker lamp	Kennzeichenbeleuchtung Numberplate lamp	Rückstrahler Reflex reflector	Anschluss / connector	Vergleichsnummer comparison number	Artikelnummer part number
F, FL, FS > 9/98	098 292 715	1	●		●	●	●	●			●		A	1620476	098 212 711
F, FL, FS > 9/98	098 292 715	1	●		●	●	●	●					A	1620477	098 212 721
F, FL, FH > 8/93-7/98	098 292 793	2	●		●	●	●	●	●	●	●	●	B	8191747 8191743 8191745	098 214 465
F, FL, FH > 8/93-7/98		2	●		●	●	●	●	●	●		●	B	8191748	098 214 475
FL, FM, FH 8/93 >	098 293 163	3	●		●	●	●	●	●	●	●	●	Cs	3981455	098 213 141
FL, FM, FH 8/93 >	098 293 163	3	●		●	●	●	●	●	●		●	Cs	3981456	098 213 151
AMP Stecker / AMP plug connector								098 213 141 / 151							099 111 493
Lichtscheibe für Rückstrahler und Seitenmarkierungsleuchte lens for reflex reflector and side marker lamp								098 214 465 / 475							098 292 959

Fig. 1

Ⓔ

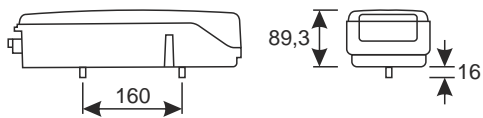
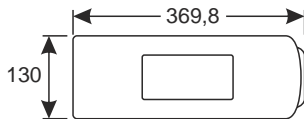
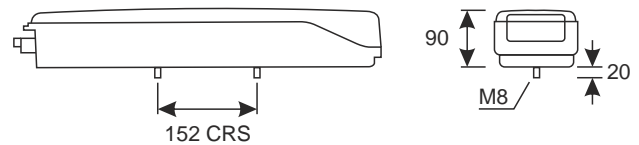
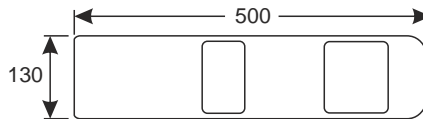

Fig. 2

Ⓔ



As



7 pol DIN (s)



As = **Anschlussstecker seitlich**
connector lateral



099 111 493

Bezeichnung Name	Lichtscheibe / lens	Fig. Nr.	Links / left	Rechts / right	Blinker, Heck- und Brems- leuchte / indicator, tail- and stop lamp	2. Heckleuchte / tail lamp	Rückfahrcheinwerfer Reverse lamp	Nebelschlussleuchte Rear fog lamp	Positionslampe hinten Tail position lamp	Seitenmarkierungsleuchte side marker lamp	Kennzeichenbeleuchtung Numberplate lamp	Rückstrahler Reflex reflector	Anschluss / connector	R.-warner / back up alarm	Vergleichsnummer comparison number	Artikelnummer part number
FL, FM 01 >	198 294 442	1	●		●	●	●	●	●	●		●	As		20425727	198 214 440
FL, FM 01 >	198 294 442	1		●	●	●	●	●	●	●		●	As		20425729	198 214 445
FL, FM 01 >	198 294 442	1	●		●	●	●	●	●	●	●	●	As		20425728	198 214 450
FL, FM 01 >	198 274 442	1		●	●	●	●	●	●			●	As	●		198 214 455
FH 2005 >	198 294 523	2		●	●	●	●	●	●	●		●	As		20565106	198 214 510
FH 2005 >	198 294 523	2	●		●	●	●	●	●	●		●	As		20565105	198 214 515
FH 2005 >	198 294 523	2	●		●	●	●	●	●	●	●	●	As		20565103	198 214 520
AMP Stecker / AMP plug connector													As		099 111 493	

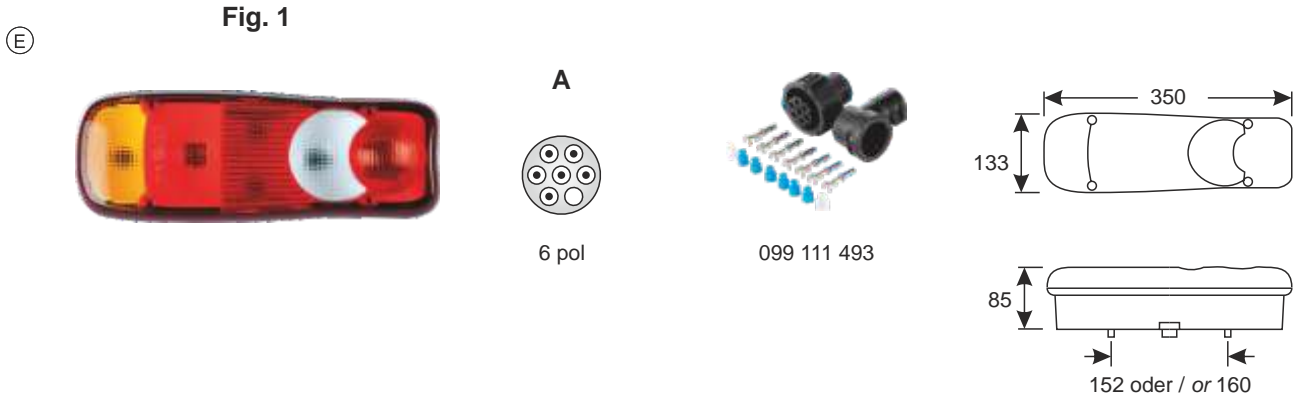

Bezeichnung Name	Lichtscheibe / lens	Fig. Nr.	Links / left	Rechts / right	Blinker, Heck- und Brems- leuchte / indicator, tail- and stop lamp	2. Heckleuchte / tail lamp	Rückfahrcheinwerfer Reverse lamp	Nebelschlussleuchte Rear fog lamp	Positionslampe hinten Tail position lamp	Seitenmarkierungsleuchte side marker lamp	Kennzeichenbeleuchtung Numberplate lamp	Rückstrahler Reflex reflector	Anschluss / connector	R.-warner / back up alarm	Vergleichsnummer comparison number	Artikelnummer part number
FL II, FE II 06 >	098 292 919	1	●		●	●	●	●	●	●	●	●	A		20769783	098 212 910
FL II, FE II 06 >	098 292 919	1	●	●	●	●	●	●	●	●		●	A		20769784	098 212 912
FL II, FE II 06 >	098 292 919	1	●	●	●	●	●	●	●	●		●	A			098 212 926*
Stecker 6 pol / plug 6 pole															099 111 493	

* = mit Anschlusskabel 2.000mm mit 2 poligem AMP Stecker für Kennzeichenleuchte
with connection wire 2.000mm with 2 pole AMP plug for numberplate lamp

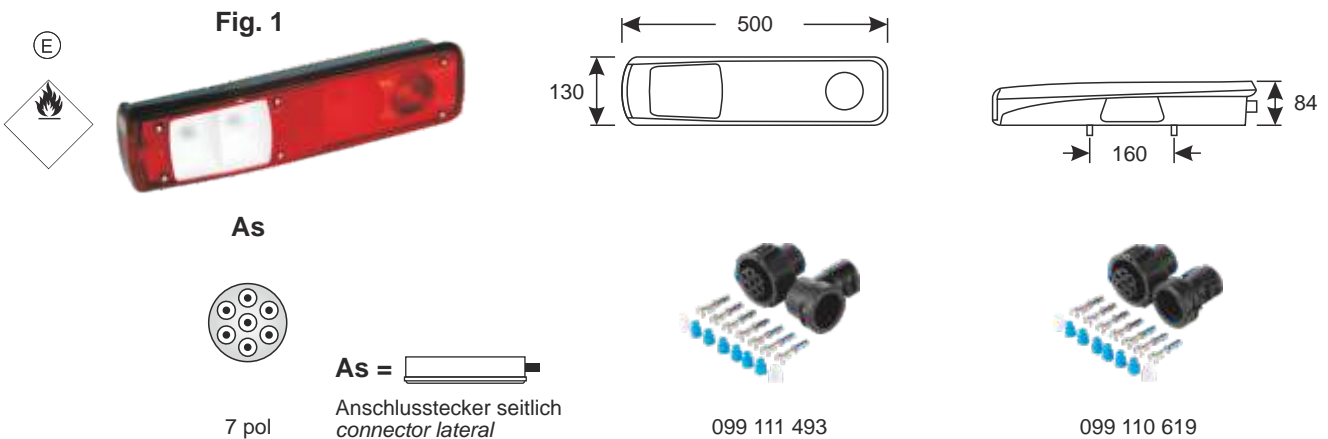

Bezeichnung Name	Lichtscheibe / lens	Fig. Nr.	Links / left	Rechts / right	Blinker, Heck- und Brems- leuchte / indicator, tail- and stop lamp	2. Heckleuchte / tail lamp	Rückfahrcheinwerfer Reverse lamp	Nebelschlussleuchte Rear fog lamp	Rückfahrwarner backup alarm	Seitenmarkierungsleuchte side marker lamp	Kennzeichenbeleuchtung Numberplate lamp	Rückstrahler Reflex reflector	Anschluss / connector	Vergleichsnummer comparison number	Artikelnummer part number
FL II, FE II 06 >	098 292 903	1	●		●	●		●		●		●	As	20802346	098 212 900
FL II, FE II 06 >	098 292 903	1		●	●	●		●		●	●	●	As	20802350	098 212 901
FL II, FE II 06 >	098 292 903	1		●	●	●	●		●	●		●	As	20802353	098 212 902*
AMP Stecker 90° / AMP plug 90°															099 111 493
AMP Stecker 180° / AMP plug 180°															099 110 619

* = mit Rückfahrwarner / with backup alarm

098 018 200.....21	098 076 211.....39	098 109 965.....49	098 212 892.....24	098 213 356.....41
098 018 201.....21	098 076 220.....39	098 109 966.....49	098 212 895.....55	098 213 366.....41
098 018 202.....21	098 076 221.....39	098 109 969.....50	098 212 896.....55	098 213 381.....41
098 018 203.....21	098 076 230.....39	098 109 980.....51	098 212 897.....55	098 213 391.....41
098 018 204.....21	098 076 231.....39	098 109 981.....51	098 212 900.....48	098 214 465.....66
098 018 205.....21	098 081 334.....27	098 110 001.....61	098 212 900.....68	098 214 475.....66
098 018 208.....21	098 081 335.....27	098 110 002.....61	098 212 901.....48	098 215 890.....24
098 018 209.....21	098 082 001.....61	098 110 003.....61	098 212 901.....68	098 215 890.....55
098 018 210.....21	098 082 002.....61	098 110 004.....61	098 212 902.....48	098 215 891.....24
098 018 211.....21	098 082 005.....61	098 110 005.....63	098 212 902.....68	098 215 891.....55
098 018 291.....16	098 082 006.....61	098 110 006.....63	098 212 903.....6	098 221 220.....30
098 018 292.....16	098 082 009.....63	098 143 011.....26	098 212 904.....6	098 221 220.....36
098 018 360.....18	098 082 010.....57	098 143 011.....33	098 212 905.....6	098 221 222.....31
098 018 361.....18	098 082 010.....63	098 143 021.....26	098 212 906.....6	098 221 225.....30
098 055 003.....7	098 082 012.....57	098 143 021.....33	098 212 907.....6	098 221 225.....34
098 055 003.....13	098 083 005.....45	098 143 910.....26	098 212 908.....6	098 221 245.....50
098 055 004.....7	098 083 006.....45	098 143 910.....33	098 212 910.....5	098 221 245.....53
098 055 004.....13	098 089 190.....45	098 143 920.....26	098 212 910.....47	098 221 265.....57
098 055 092.....9	098 089 290.....46	098 143 920.....33	098 212 910.....68	098 221 265.....62
098 055 094.....9	098 089 291.....46	098 148 184.....42	098 212 912.....5	098 221 265.....64
098 055 096.....11	098 089 335.....8	098 148 185.....42	098 212 912.....47	098 221 357.....31
098 055 098.....11	098 089 336.....8	098 148 221.....2	098 212 912.....68	098 221 357.....35
098 055 117.....11	098 103 315.....56	098 148 222.....2	098 212 926.....68	098 221 357.....37
098 055 118.....11	098 103 325.....59	098 148 223.....2	098 212 953.....5	098 221 357.....38
098 055 202.....49	098 103 330.....59	098 148 224.....2	098 212 953.....23	098 221 357.....40
098 055 202.....51	098 103 400.....56	098 148 225.....2	098 212 954.....5	098 221 370.....17
098 055 203.....49	098 103 401.....56	098 148 226.....2	098 212 954.....23	098 221 371.....17
098 055 203.....51	098 106 976.....42	098 148 991.....49	098 212 956.....5	098 221 373.....17
098 055 204.....49	098 106 977.....42	098 148 992.....49	098 212 956.....23	098 221 374.....17
098 055 204.....51	098 109 093.....25	098 150 021.....35	098 212 956.....47	098 221 376.....17
098 055 205.....49	098 109 093.....25	098 150 022.....35	098 212 957.....5	098 221 377.....50
098 055 205.....51	098 109 093.....25	098 151 001.....16	098 212 957.....23	098 221 377.....52
098 055 315.....7	098 109 093.....32	098 153 001.....63	098 212 957.....47	098 221 377.....56
098 055 315.....9	098 109 093.....32	098 153 002.....63	098 212 958.....23	098 221 377.....60
098 055 316.....7	098 109 093.....32	098 153 016.....26	098 212 961.....15	098 221 381.....4
098 055 316.....9	098 109 700.....1	098 153 016.....33	098 212 962.....15	098 221 381.....8
098 055 613.....51	098 109 701.....1	098 153 026.....26	098 212 963.....54	098 221 381.....10
098 055 614.....51	098 109 702.....1	098 153 026.....33	098 212 964.....54	098 221 381.....13
098 056 500.....1	098 109 703.....1	098 153 334.....59	098 212 991.....15	098 221 381.....43
098 056 501.....1	098 109 704.....45	098 153 335.....59	098 212 992.....15	098 221 381.....45
098 056 502.....1	098 109 705.....45	098 153 336.....59	098 212 993.....15	098 221 381.....46
098 056 503.....1	098 109 706.....1	098 153 337.....59	098 212 994.....15	098 221 381.....58
098 056 504.....1	098 109 707.....1	098 200 800.....16	098 213 141.....66	098 221 397.....4
098 056 505.....1	098 109 708.....43	098 212 711.....66	098 213 151.....66	098 221 837.....3
098 056 690.....1	098 109 709.....43	098 212 721.....66	098 213 161.....54	098 221 837.....58
098 056 691.....1	098 109 836.....37	098 212 770.....5	098 213 162.....54	098 221 838.....44
098 069 715.....44	098 109 836.....37	098 212 806.....5	098 213 163.....54	098 222 230.....40
098 069 716.....44	098 109 837.....37	098 212 807.....5	098 213 167.....54	098 222 231.....40
098 076 113.....37	098 109 837.....37	098 212 830.....14	098 213 168.....54	098 222 317.....7
098 076 114.....37	098 109 840.....39	098 212 835.....14	098 213 171.....54	098 222 317.....8
098 076 123.....37	098 109 840.....39	098 212 855.....14	098 213 180.....41	098 222 317.....10
098 076 124.....37	098 109 841.....39	098 212 865.....14	098 213 190.....41	098 222 317.....12
098 076 200.....39	098 109 841.....39	098 212 875.....14	098 213 220.....54	098 222 318.....7
098 076 201.....39	098 109 842.....28	098 212 890.....24	098 213 230.....54	098 222 318.....8
098 076 210.....39	098 109 843.....28	098 212 891.....24	098 213 346.....41	098 222 318.....10

098 222 318.....12	098 223 075.....52	098 291 375.....17	099 110 006.....30	099 110 469.....29
098 222 321.....10	098 223 920.....9	098 291 375.....17	099 110 006.....33	099 110 469.....34
098 222 321.....12	098 223 930.....9	098 291 378.....50	099 110 006.....34	099 110 469.....36
098 222 322.....10	098 230 010.....2	098 291 378.....52	099 110 006.....42	099 110 469.....40
098 222 322.....12	098 230 010.....42	098 291 378.....56	099 110 006.....45	099 110 618.....1
098 222 323.....11	098 230 010.....46	098 291 378.....60	099 110 006.....49	099 110 618.....5
098 222 324.....11	098 230 010.....57	098 291 381.....2	099 110 006.....49	099 110 619.....48
098 222 400.....42	098 230 020.....26	098 291 381.....4	099 110 006.....51	099 110 619.....68
098 222 400.....42	098 230 020.....33	098 291 381.....8	099 110 006.....51	099 110 620.....25
098 222 400.....46	098 230 020.....38	098 291 381.....10	099 110 006.....57	099 110 620.....25
098 222 410.....42	098 230 020.....39	098 291 381.....13	099 110 006.....58	099 110 620.....25
098 222 410.....42	098 230 030.....26	098 291 381.....43	099 110 010.....29	099 110 620.....27
098 222 410.....46	098 230 030.....33	098 291 381.....45	099 110 010.....30	099 110 620.....28
098 222 417.....10	098 230 030.....38	098 291 381.....46	099 110 010.....31	099 110 620.....32
098 222 417.....12	098 230 030.....39	098 291 381.....57	099 110 010.....34	099 110 620.....32
098 222 418.....10	098 230 040.....8	098 291 381.....58	099 110 010.....36	099 110 620.....32
098 222 418.....12	098 230 040.....9	098 291 510.....3	099 110 010.....38	099 110 620.....35
098 222 802.....20	098 230 040.....11	098 291 510.....42	099 110 010.....38	099 110 620.....36
098 222 805.....16	098 230 050.....8	098 291 510.....43	099 110 010.....40	099 110 620.....37
098 222 808.....16	098 230 050.....9	098 291 510.....44	099 110 019.....4	099 110 620.....37
098 222 850.....3	098 230 050.....11	098 291 510.....56	099 110 019.....50	099 110 620.....39
098 223 001.....29	098 230 610.....49	098 291 510.....58	099 110 019.....51	099 110 620.....39
098 223 001.....34	098 230 610.....52	098 292 775.....5	099 110 019.....52	099 110 624.....4
098 223 001.....38	098 231 381.....2	098 292 775.....23	099 110 019.....56	099 110 629.....41
098 223 002.....29	098 231 381.....57	098 292 891.....6	099 110 019.....60	099 110 635.....57
098 223 002.....34	098 231 810.....19	098 292 892.....6	099 110 049.....14	099 110 635.....62
098 223 002.....38	098 231 810.....22	098 292 919.....5	099 110 051.....2	099 110 635.....64
098 223 005.....29	098 233 051.....59	098 292 919.....47	099 110 051.....2	099 110 635.....64
098 223 005.....33	098 233 053.....64	098 292 919.....68	099 110 051.....7	099 110 636.....49
098 223 007.....29	098 236 827.....44	098 292 959.....5	099 110 051.....9	099 110 636.....50
098 223 007.....33	098 236 829.....44	098 292 959.....15	099 110 051.....11	099 110 636.....52
098 223 009.....29	098 236 829.....45	098 292 959.....23	099 110 129.....7	099 110 636.....52
098 223 009.....34	098 242 820.....44	098 292 959.....47	099 110 129.....8	099 110 636.....53
098 223 010.....29	098 242 820.....45	098 292 959.....54	099 110 129.....9	099 110 636.....63
098 223 010.....34	098 242 901.....27	098 292 959.....66	099 110 129.....9	099 110 636.....65
098 223 013.....36	098 242 901.....28	098 293 014.....50	099 110 129.....9	099 110 647.....14
098 223 013.....40	098 254 096.....4	098 293 015.....50	099 110 129.....10	099 110 647.....15
098 223 016.....62	098 254 096.....46	098 293 018.....56	099 110 129.....10	099 110 741.....4
098 223 017.....62	098 254 096.....58	098 293 022.....64	099 110 129.....11	099 110 741.....8
098 223 020.....64	098 254 161.....18	098 293 023.....64	099 110 129.....11	099 110 741.....10
098 223 021.....64	098 291 005.....61	098 293 024.....62	099 110 129.....12	099 110 741.....13
098 223 022.....62	098 291 233.....24	098 293 025.....62	099 110 129.....12	099 110 741.....43
098 223 023.....62	098 291 235.....50	098 293 309.....30	099 110 129.....13	099 110 741.....45
098 223 046.....36	098 291 235.....53	098 293 309.....30	099 110 145.....6	099 110 741.....46
098 223 047.....36	098 291 235.....63	098 293 309.....31	099 110 152.....41	099 110 743.....36
098 223 050.....59	098 291 235.....65	098 293 309.....34	099 110 378.....3	099 110 743.....40
098 223 053.....62	098 291 266.....57	098 293 309.....36	099 110 378.....42	099 111 032.....7
098 223 055.....56	098 291 266.....62	098 299 972.....59	099 110 378.....43	099 111 032.....9
098 223 056.....56	098 291 266.....64	098 299 972.....59	099 110 378.....44	099 111 032.....11
098 223 060.....1	098 291 357.....30	098 299 973.....59	099 110 378.....56	099 111 116.....27
098 223 060.....3	098 291 357.....36	098 400 020.....24	099 110 378.....58	099 111 116.....28
098 223 061.....1	098 291 358.....30	098 400 200.....55	099 110 386.....26	099 111 116.....31
098 223 061.....3	098 291 358.....36	099 110 006.....1	099 110 386.....33	099 111 116.....35
098 223 062.....3	098 291 372.....17	099 110 006.....2	099 110 386.....46	099 111 116.....35
098 223 070.....52	098 291 372.....17	099 110 006.....29	099 110 386.....58	099 111 116.....35

099 111 11636	198 076 323.....37	198 109 835.....25	198 223 045.....29	910 213 050.....23
099 111 11637	198 076 324.....37	198 109 835.....25	198 223 045.....34	910 213 051.....23
099 111 11638	198 081 117.....25	198 109 835.....32	298 018 206.....21	910 221 835.....42
099 111 11640	198 081 117.....32	198 109 835.....32	298 018 207.....21	910 221 836.....43
099 111 11640	198 081 118.....25	198 109 835.....32	298 018 347.....18	910 222 603.....17
099 111 40116	198 081 118.....32	198 109 83828	298 018 348.....18	910 222 604.....17
099 111 41017	198 081 119.....25	198 109 839.....28	298 018 351.....18	910 222 806.....19
099 111 41020	198 081 119.....32	198 109 867.....16	298 018 352.....18	
099 111 41022	198 081 120.....25	198 109 868.....16	298 055 315.....7	
099 111 43917	198 081 120.....32	198 109 880.....18	298 055 315.....9	
099 111 43918	198 081 121.....25	198 109 881.....18	298 055 316.....7	
099 111 43922	198 081 121.....32	198 109 883.....21	298 055 316.....9	
099 111 48154	198 081 122.....25	198 109 884.....21	298 081 161.....27	
099 111 49341	198 081 122.....32	198 109 885.....21	298 081 261.....27	
099 111 49347	198 081 161.....27	198 109 886.....21	298 081 330.....28	
099 111 49348	198 081 261.....27	198 148 338.....16	298 081 331.....28	
099 111 49366	198 081 317.....25	198 148 339.....16	298 081 336.....28	
099 111 49367	198 081 317.....32	198 153 056.....27	298 081 337.....28	
099 111 49368	198 081 318.....25	198 153 056.....28	298 081 361.....27	
099 111 49368	198 081 318.....32	198 153 066.....35	298 081 461.....27	
099 111 64818	198 081 319.....25	198 153 156.....27	298 082 003.....61	
099 111 64823	198 081 319.....32	198 153 156.....28	298 082 004.....61	
099 111 64824	198 081 320.....25	198 153 166.....35	298 082 005.....61	
099 111 64855	198 081 320.....32	198 214 440.....67	298 082 006.....61	
099 111 64855	198 081 321.....25	198 214 445.....67	298 082 007.....63	
099 111 67219	198 081 321.....32	198 214 450.....67	298 082 008.....63	
099 111 67221	198 081 322.....25	198 214 455.....67	298 082 009.....63	
099 111 68619	198 081 322.....32	198 214 510.....67	298 082 01163	
099 111 68620	198 081 332.....28	198 214 515.....67	298 082 020.....63	
099 111 68620	198 081 333.....28	198 214 520.....67	298 082 021.....63	
099 111 68622	198 081 338.....28	198 221 357.....31	298 143 050.....21	
099 111 68819	198 081 339.....28	198 221 357.....35	298 143 051.....21	
099 111 68820	198 081 361.....27	198 221 357.....37	298 153 003.....63	
099 111 68820	198 081 461.....27	198 221 357.....38	298 153 004.....63	
099 111 68822	198 083 001.....43	198 221 357.....40	298 153 005.....64	
099 111 68919	198 083 002.....43	198 221 381.....4	298 153 006.....64	
099 111 68920	198 083 007.....43	198 221 381.....8	298 153 007.....64	
099 111 68920	198 083 008.....43	198 221 381.....10	298 153 008.....64	
099 111 68922	198 103 110.....49	198 221 381.....13	298 153 056.....27	
099 450 995.....24	198 103 120.....49	198 221 381.....43	298 153 056.....28	
099 450 995.....55	198 103 130.....51	198 221 381.....45	298 153 156.....27	
198 018 289.....16	198 103 140.....51	198 221 381.....46	298 153 156.....28	
198 018 290.....16	198 103 150.....51	198 221 381.....58	298 221 230.....50	
198 018 347.....18	198 103 160.....51	198 221 704.....20	298 221 230.....53	
198 018 348.....18	198 106 974.....42	198 221 705.....18	298 221 230.....63	
198 018 351.....18	198 106 975.....42	198 221 705.....22	298 221 230.....65	
198 018 352.....18	198 109 832.....27	198 222 789.....19	298 221 701.....22	
198 054 315.....7	198 109 833.....27	198 222 790.....19	298 222 791.....19	
198 054 316.....7	198 109 834.....25	198 222 791.....19	298 222 792.....19	
198 055 102.....11	198 109 834.....25	198 222 792.....19	298 222 793.....19	
198 055 103.....11	198 109 834.....25	198 222 801.....20	298 222 794.....19	
198 055 313.....13	198 109 834.....32	198 222 803.....20	298 223 042.....38	
198 055 314.....13	198 109 834.....32	198 222 803.....22	298 223 042.....40	
198 076 313.....37	198 109 834.....32	198 223 044.....29	298 223 043.....38	
198 076 314.....37	198 109 835.....25	198 223 044.....34	298 223 043.....40	



81.25101-6289.....	398 018 289	81.25260-6097.....	398 221 701
81.25101-6290.....	398 018 290	81.25260-6101.....	398 221 701
81.25101-6291.....	398 018 291	81.25260-6104.....	398 221 704
81.25101-6292.....	398 018 292	81.25260-6105.....	398 221 705
81.25101-6338.....	398 148 338	81.25260-6105.....	398 221 705
81.25101-6339.....	398 148 339	81.25260-6121.....	398 231 810
81.25101-6347.....	398 018 347	81.25260-6121.....	398 231 810
81.25101-6348.....	398 018 348	81.25320-6088.....	398 222 801
81.25101-6351.....	398 018 351	81.25320-6091.....	398 222 791
81.25101-6352.....	398 018 348	81.25320-6092.....	398 222 792
81.25101-6352.....	398 018 352	81.25320-6100.....	398 222 806
81.25101-6419.....	398 018 347	81.25320-6101.....	398 222 801
81.25101-6420.....	398 018 348	81.25320-6111.....	398 222 791
81.25101-6421.....	398 018 351	81.25320-6112.....	398 222 792
81.25101-6422.....	398 018 352	81.25320-6113.....	398 222 793
81.25101-6427.....	398 018 347	81.25320-6114.....	398 222 794
81.25101-6448.....	398 018 348	81.25320-6115.....	398 222 801
81.25101-6449.....	398 018 347	81.25320-6117.....	398 222 801
81.25101-6450.....	398 018 352	81.25320-6118.....	398 222 803
81.25101-6451.....	398 018 351		
81.25101-6496.....	398 018 201		
81.25101-6497.....	398 018 200		
81.25101-6498.....	398 018 205		
81.25101-6499.....	398 018 204		
81.25101-6500.....	398 018 203		
81.25101-6501.....	398 018 202		
81.25101-6503.....	398 018 206		
81.25101-6504.....	398 018 207		
81.25101-6521.....	398 143 050		
81.25101-6522.....	398 143 051		
81.25101-6577.....	398 018 348		
81.25101-6578.....	398 018 347		
81.25101-6579.....	398 018 352		
81.25101-6580.....	398 018 351		
81.25101-6657.....	398 018 200		
81.25101-6658.....	398 018 201		
81.25101-6659.....	398 018 204		
81.25101-6660.....	398 018 205		
81.25101-6661.....	398 018 202		
81.25101-6662.....	398 018 203		
81.25101-6663.....	398 018 206		
81.25101-6664.....	398 018 207		
81.25102-6039.....	398 200 800		
81.25110-0067.....	398 109 867		
81.25110-0068.....	398 109 868		
81.25110-0080.....	398 109 880		
81.25110-0081.....	398 109 881		
81.25110-0083.....	398 109 883		
81.25110-0084.....	398 109 884		
81.25110-0085.....	398 109 885		
81.25110-0086.....	398 109 886		
81.25260-6080.....	398 221 704		
81.25260-6084.....	398 221 704		
81.25260-6084.....	398 221 701		
81.25260-6096.....	398 221 701		



Wir vertreiben ein umfangreiches Programm an Fahrzeugteilen in Erstausrüsterqualität namhafter europäischer Hersteller, wobei wir seit mehr als 15 Jahren ein kompetenter und zuverlässiger Partner für Handel, Industrie und Erstausrüstung sind.

We sell a large program of vehicle-parts in OEM quality from European manufacturers. For more than 15 years, we are a competent and reliable partner for wholesalers, industry and OEM.



Unser breites Sortiment an Teilen für Nutzfahrzeuge und unser gut geführtes Lager in Wien garantieren kürzeste Lieferzeiten für unsere Handelspartner in Österreich und vielen Ländern Europas.

Our wide range of parts for commercial vehicles and our well assorted warehouse in Vienna, enable us to grant a fast delivery service for our trade partners in Austria and many European countries.



Die enge Zusammenarbeit mit unseren Produktionspartnern in der ganzen Welt macht es möglich, auch Sonderanfertigungen für Groß- und Kleinserien innerhalb kurzer Zeit zu realisieren.

Close cooperation with our production partners all over the world, put us into position to realize special products as well for large and small series within short time.



900 100 050



BELEUCHTUNG LKW
LIGHTING TRUCKS

Ed. 2



R.A.L. Handels GmbH.

Lohnergasse 1

A-1210 Wien

Tel.: +43(0)1/270 76 01 -0

Fax: +43(0)1/278 77 36

www.ermax.at

www.ral.at

www.fahrzeugbedarf.at

www.trailerline.eu



Preis € 6,-