



**PRODUCTS FOR YOUR
MAN TRUCK**



Lighting

Page 3 - 108



Water Pump, Wiper Blade

Page 109 - 164



Mirrors, Mirror Glasses

Page 165 - 221



Cap (Fuel tank)

Page 222 - 253



Starter

Page 254 - 290



Generator

Page 291 - 399



Air Conditioning

Page 400 - 450



Heating/Ventilation

Page 451 - 498

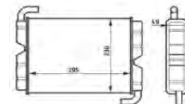

Cooling

Page 499 - 583



Oil Cooler

Page 584 - 591

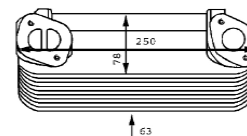

Intercooler, Charger

Page 592 - 626

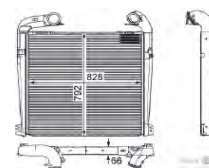

Oil Cooler, Retarder

Page 627 - 646



Combination Rearlight.....	34
Diffusing Lens, headlight.....	4
Fog Light.....	5
Headlight.....	8
Housing, combination rearlight.....	26
Housing, licence plate light.....	27
Indicator.....	46
Insert, headlight.....	28
Lens, combination rearlight.....	31
Lens, marker lamp.....	33
Licence Plate Light.....	44
Marker Lamp.....	45
Position Light.....	45
Side Marker Light.....	45
Spotlight.....	22
Worklight.....	25

Diffusing Lens, headlight

9ES 120 743-001
094122, E1 24496, E1 24540

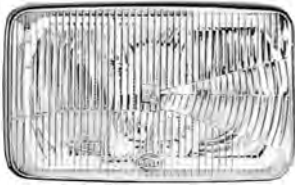

Bulb Type	H4
Fitting Position	<ul style="list-style-type: none"> • Left • Right
Inspection Tag	<ul style="list-style-type: none"> • E1 24496 • E1 24540
Left-hand / Right-hand Traffic	for right-hand traffic

9ES 354 984-051

Fitting Position	Left
Supplementary Article/Supplementary Info	without gasket / seal

9ES 354 984-061

Fitting Position	Right
Supplementary Article/Supplementary Info	without gasket / seal

9ES 354 987-091

Fitting Position	Left
Supplementary Article/Supplementary Info	without gasket / seal

9ES 354 987-101

Fitting Position	Right
Supplementary Article/Supplementary Info	without gasket / seal

Headlight - Fog Light

1FP 354 986-011

Bulb Type	H4
Fitting Position	Left
Rated Voltage [V]	24
Supplementary Article/Supplementary Info 2	with bulbs

1FP 354 986-021

Bulb Type	H4
Fitting Position	Right
Rated Voltage [V]	24
Supplementary Article/Supplementary Info 2	with bulbs

1NB 003 367-137 E1 8345

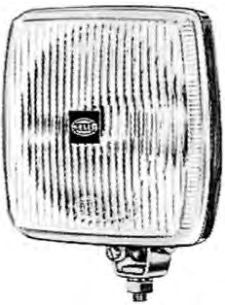

Bulb Type	H3
Colour	Black
Fitting Position	<ul style="list-style-type: none"> • Left • Right
Inspection Tag	E1 8345
Light Design	Halogen
Light Function	with fog light
Mounting Type	mounting
Rated Voltage [V]	24

1NB 354 986-031

Bulb Type	<ul style="list-style-type: none"> • P21W • H4
Fitting Position	Left
Lens Colour	Yellow
Light Function	<ul style="list-style-type: none"> • with indicator • with high beam • with fog light
Rated Voltage [V]	24
Supplementary Article/Supplementary Info 2	with bulbs

Headlight - Fog Light

1NB 354 986-041

Bulb Type	<ul style="list-style-type: none"> • P21W • H4
Fitting Position	Right
Lens Colour	Yellow
Light Function	<ul style="list-style-type: none"> • with indicator • with high beam • with fog light
Rated Voltage [V]	24
Supplementary Article/Supplementary Info 2	with bulbs

1NB 354 986-051

Bulb Type	<ul style="list-style-type: none"> • H4 • PY21W
Fitting Position	Left
Lens Colour	White
Light Function	<ul style="list-style-type: none"> • with indicator • with high beam • with fog light
Rated Voltage [V]	24
Supplementary Article/Supplementary Info 2	with bulbs

1NB 354 986-061

Bulb Type	<ul style="list-style-type: none"> • H4 • PY21W
Fitting Position	Right
Lens Colour	White
Light Function	<ul style="list-style-type: none"> • with indicator • with high beam • with fog light
Rated Voltage [V]	24
Supplementary Article/Supplementary Info 2	with bulbs

1NB 354 986-071

Bulb Type	H3
Fitting Position	Left
Light Design	Halogen
Light Function	<ul style="list-style-type: none"> • with high beam • with fog light
Rated Voltage [V]	24
Supplementary Article/Supplementary Info 2	with bulbs

1NB 354 986-081

Bulb Type	H3
Fitting Position	Right
Light Design	Halogen
Light Function	<ul style="list-style-type: none"> • with high beam • with fog light
Rated Voltage [V]	24
Supplementary Article/Supplementary Info 2	with bulbs

Headlight - Fog Light

1NE 006 300-051
Jumbo 220, E1 18231

H3 fog lamp



Bulb Type	H3
Fastening Type	<ul style="list-style-type: none"> • Suspended • Vertical
Fitting Depth [mm]	89
Fitting Position	<ul style="list-style-type: none"> • Left • Right
Height [mm]	133
Housing Colour	Black
Illuminated Area [mm]	205 x 110
Inspection Tag	E1 18231
Lens Colour	Transparent
Light Design	Halogen
Light Function	with fog light
Mounting Type	mounting
Overall Height [mm]	166
Rated Voltage [V]	<ul style="list-style-type: none"> • 12 • 24
Width [mm]	242

Spare Parts

1 x 1NE 138 555-011 Insert, fog light

Accessories

 1 x 8GH 002 090-133 Bulb

 1 x 8GH 002 090-251 Bulb

Headlight

1A8 003 060-541
010068, E1 14549

Headlamp, not suitable for headlamp leveller



Bulb Type	<ul style="list-style-type: none"> • T4W • R2 (Bilux)
Diameter [mm]	182
Fitting Position	<ul style="list-style-type: none"> • Left • Right
Illuminated Area [mm]	182
Inspection Tag	E1 14549
Left-hand / Right-hand Traffic	for right-hand traffic
Light Function	<ul style="list-style-type: none"> • with low beam • with position light • with high beam
Mounting Type	<ul style="list-style-type: none"> • mounting • Fitting
Rated Voltage [V]	<ul style="list-style-type: none"> • 12 • 24
Shape	Round
Supplementary Article/Supplementary Info 2	without indicator lamp

Spare Parts



1 x 1A8 121 149-001 Insert, headlight

1 x 9FF 126 444-001 Bulb Socket, headlight

1 x 9GH 116 966-011 Cap, headlight

Accessories



1 x 8GD 002 088-131 Bulb



1 x 8GP 002 067-121 Bulb

Headlight

1A8 003 060-551
E1 14551, E1 34495, 012140



Bulb Type	<ul style="list-style-type: none"> • T4W • H4
Diameter [mm]	182
Fitting Position	<ul style="list-style-type: none"> • Left • Right
Illuminated Area [mm]	182
Inspection Tag	<ul style="list-style-type: none"> • E1 14551 • E1 34495
Left-hand / Right-hand Traffic	for right-hand traffic
Light Design	Halogen
Light Function	<ul style="list-style-type: none"> • with low beam • with position light • with high beam
Mounting Type	<ul style="list-style-type: none"> • mounting • Fitting
Rated Voltage [V]	<ul style="list-style-type: none"> • 12 • 24
Shape	Round
Supplementary Article/Supplementary Info 2	without indicator lamp

Spare Parts



1 x 1A8 121 150-001 Insert, headlight

1 x 9GH 116 966-011 Cap, headlight

Accessories



1 x 8GJ 002 525-131 Bulb, spotlight

1 x 8GP 002 067-121 Bulb

1 x 9FF 126 444-001 Bulb Socket, headlight

Headlight

1AG 003 434-211
012481, E1 24496, E1 24540

Only for spare parts requirement
H4 headlamp, with device for headlamp leveller







Bulb Type	<ul style="list-style-type: none"> • T4W • H4
Colour	Black
Fitting Position	<ul style="list-style-type: none"> • Left • Right
Inspection Tag	<ul style="list-style-type: none"> • E1 24496 • E1 24540
Left-hand / Right-hand Traffic	for right-hand traffic
Light Design	Halogen
Light Function	<ul style="list-style-type: none"> • with low beam • with position light • with high beam
Mounting Type	Fitting
Rated Voltage [V]	<ul style="list-style-type: none"> • 12 • 24

Spare Parts

	1 x 9ES 120 743-001 Diffusing Lens, headlight
	1 x 9GD 122 217-001 Seal, headlight
	1 x 9HD 121 297-035 Cap, headlight

Accessories

	1 x 8GJ 002 525-131 Bulb, spotlight
	1 x 8GJ 002 525-251 Bulb, spotlight
	1 x 8GP 002 067-121 Bulb
	1 x 8GP 002 067-241 Bulb

Headlight

1AG 003 434-251
E1 24540, E1 24496, 012165

Only for spare parts requirement



Bulb Type	<ul style="list-style-type: none"> • T4W • H4
Colour	Black
Depth [mm]	198
Fitting Position	<ul style="list-style-type: none"> • Left • Right
Height [mm]	195
Illuminated Area [mm]	270 x 170
Inspection Tag	<ul style="list-style-type: none"> • E1 24496 • E1 24540 • IP5K4K
Left-hand / Right-hand Traffic	for right-hand traffic
Light Design	Halogen
Light Function	<ul style="list-style-type: none"> • with low beam • with position light • with high beam
Mounting Type	Fitting
Rated Voltage [V]	<ul style="list-style-type: none"> • 12 • 24
Supplementary Article/Supplementary Info 2	without indicator lamp
Vehicle Equipment	for vehicles with headlamp levelling
Width [mm]	352

Spare Parts

	1 x 9ES 120 743-001 Diffusing Lens, headlight
	1 x 9GT 067 751-001 Grommet
	1 x 9HD 121 297-035 Cap, headlight

Accessories

	1 x 8GJ 002 525-131 Bulb, spotlight
	1 x 8GJ 002 525-251 Bulb, spotlight
	1 x 8GP 002 067-121 Bulb
	1 x 8GP 002 067-241 Bulb

Headlight

1D3 009 027-011
E12 8042

HELLA



Bulb Type	<ul style="list-style-type: none"> • P21W • W5W • H7 / H7
Fitting Position	Left
Indicator Colour	Yellow
Inspection Tag	E12 8042
Left-hand / Right-hand Traffic	for right-hand traffic
Light Design	Halogen
Light Function	<ul style="list-style-type: none"> • with low beam • with position light • with indicator • with high beam
Mounting Type	<ul style="list-style-type: none"> • mounting • Fitting
Rated Voltage [V]	24
Supplementary Article/Supplementary Info 2	with bulbs
Vehicle Equipment	for vehicles without head-lamp levelling

Spare Parts

	1 x 8GA 002 073-241 Bulb
	2 x 8GH 007 157-241 Bulb
	1 x 8GP 003 594-251 Bulb

Headlight

1D3 009 027-021
E12 8042

HELLA



Bulb Type	<ul style="list-style-type: none"> • P21W • W5W • H7 / H7
Fitting Position	Right
Indicator Colour	Yellow
Inspection Tag	E12 8042
Left-hand / Right-hand Traffic	for right-hand traffic
Light Design	Halogen
Light Function	<ul style="list-style-type: none"> • with low beam • with position light • with indicator • with high beam
Mounting Type	<ul style="list-style-type: none"> • mounting • Fitting
Rated Voltage [V]	24
Supplementary Article/Supplementary Info 2	with bulbs
Vehicle Equipment	for vehicles without head-lamp levelling

Spare Parts

	1 x 8GA 002 073-241 Bulb
	2 x 8GH 007 157-241 Bulb
	1 x 8GP 003 594-251 Bulb

Headlight

1D3 009 027-031



Bulb Type	<ul style="list-style-type: none"> • P21W • W5W • H7 / H7
Fitting Position	Left
Indicator Colour	Yellow
Left-hand / Right-hand Traffic	for right-hand traffic
Light Design	Halogen
Light Function	<ul style="list-style-type: none"> • with low beam • with position light • with indicator • with high beam
Rated Voltage [V]	24
Supplementary Article/Supplementary Info 2	with bulbs
Vehicle Equipment	for vehicles with headlamp levelling (electric)

1D3 009 027-041



Bulb Type	<ul style="list-style-type: none"> • P21W • W5W • H7 / H7
Fitting Position	Right
Indicator Colour	Yellow
Left-hand / Right-hand Traffic	for right-hand traffic
Light Design	Halogen
Light Function	<ul style="list-style-type: none"> • with low beam • with position light • with indicator • with high beam
Rated Voltage [V]	24
Supplementary Article/Supplementary Info 2	with bulbs
Vehicle Equipment	for vehicles with headlamp levelling (electric)

Headlight

1EF 354 340-011



Bulb Type	<ul style="list-style-type: none"> • T4W • H4
Fitting Position	<ul style="list-style-type: none"> • Left • Right
Left-hand / Right-hand Traffic	for right-hand traffic
Light Design	Halogen
Light Function	<ul style="list-style-type: none"> • with low beam • with position light • with high beam • without indicator
Rated Voltage [V]	24
Supplementary Article/Supplementary Info 2	without bulbs
Vehicle Equipment	for vehicles without head-lamp levelling

Accessories



1 x 8GJ 002 525-251 Bulb, spotlight



1 x 8GP 002 067-241 Bulb

Headlight

1EF 354 340-021



Bulb Type	<ul style="list-style-type: none"> • T4W • H4
Fitting Position	<ul style="list-style-type: none"> • Left • Right
Left-hand / Right-hand Traffic	for right-hand traffic
Light Design	Halogen
Light Function	<ul style="list-style-type: none"> • with low beam • with position light • with high beam • without indicator
Rated Voltage [V]	24
Supplementary Article/Supplementary Info 2	<ul style="list-style-type: none"> • without bulbs • with motor for headlamp levelling
Vehicle Equipment	for vehicles with headlamp levelling (electric)

Accessories

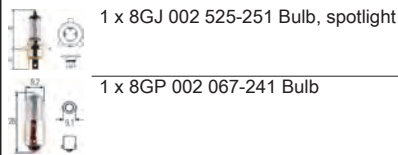

1 x 8GJ 002 525-251 Bulb, spotlight

1 x 8GP 002 067-241 Bulb

1EH 354 984-011

Bulb Type	<ul style="list-style-type: none"> • W5W • H7 / H7
Fitting Position	Left
Left-hand / Right-hand Traffic	for right-hand traffic
Light Design	Halogen
Light Function	<ul style="list-style-type: none"> • with low beam • with position light • with high beam
Rated Voltage [V]	24
Supplementary Article/Supplementary Info 2	with bulbs
Vehicle Equipment	for vehicles without headlamp levelling

1EH 354 984-021

Bulb Type	<ul style="list-style-type: none"> • W5W • H7 / H7
Fitting Position	Right
Left-hand / Right-hand Traffic	for right-hand traffic
Light Design	Halogen
Light Function	<ul style="list-style-type: none"> • with low beam • with position light • with high beam
Rated Voltage [V]	24
Supplementary Article/Supplementary Info 2	with bulbs
Vehicle Equipment	for vehicles without headlamp levelling

Headlight

1EH 354 984-031

Bulb Type	<ul style="list-style-type: none"> • W5W • H7 / H7
Fitting Position	Left
Left-hand / Right-hand Traffic	for right-hand traffic
Light Design	Halogen
Light Function	<ul style="list-style-type: none"> • with low beam • with position light • with high beam
Rated Voltage [V]	24
Supplementary Article/Supplementary Info 2	with bulbs
Vehicle Equipment	for vehicles with headlamp levelling (electric)

1EH 354 984-041

Bulb Type	<ul style="list-style-type: none"> • W5W • H7 / H7
Fitting Position	Right
Left-hand / Right-hand Traffic	for right-hand traffic
Light Design	Halogen
Light Function	<ul style="list-style-type: none"> • with low beam • with position light • with high beam
Rated Voltage [V]	24
Supplementary Article/Supplementary Info 2	with bulbs
Vehicle Equipment	for vehicles with headlamp levelling (electric)

1EH 354 987-011

Bulb Type	<ul style="list-style-type: none"> • H7 / H7 • PY21W
Fitting Position	Left
Left-hand / Right-hand Traffic	for right-hand traffic
Light Design	Halogen
Light Function	<ul style="list-style-type: none"> • with low beam • with position light • with indicator • with high beam • without daylight running light
Rated Voltage [V]	24
Supplementary Article/Supplementary Info 2	with bulbs
Vehicle Equipment	for vehicles without headlamp levelling

Headlight

1EH 354 987-021

Bulb Type	<ul style="list-style-type: none"> • H7 / H7 • PY21W
Fitting Position	Right
Left-hand / Right-hand Traffic	for right-hand traffic
Light Design	Halogen
Light Function	<ul style="list-style-type: none"> • with low beam • with position light • with indicator • with high beam • without daylight running light
Rated Voltage [V]	24
Supplementary Article/Supplementary Info 2	with bulbs
Vehicle Equipment	for vehicles without head-lamp levelling

1EH 354 987-031

Bulb Type	<ul style="list-style-type: none"> • H7 / H7 • PY21W • H21 W
Fitting Position	Left
Left-hand / Right-hand Traffic	for right-hand traffic
Light Design	Halogen
Light Function	<ul style="list-style-type: none"> • with low beam • with position light • with indicator • with daylight running light • with high beam
Rated Voltage [V]	24
Supplementary Article/Supplementary Info 2	with bulbs
Vehicle Equipment	for vehicles without head-lamp levelling

1EH 354 987-051

Bulb Type	<ul style="list-style-type: none"> • H7 / H7 • PY21W
Fitting Position	Left
Left-hand / Right-hand Traffic	for right-hand traffic
Light Design	Halogen
Light Function	<ul style="list-style-type: none"> • with low beam • with position light • with indicator • with high beam • without daylight running light
Rated Voltage [V]	24
Supplementary Article/Supplementary Info 2	with bulbs
Vehicle Equipment	for vehicles with headlamp levelling (electric)

Headlight

1EH 354 987-061

Bulb Type	<ul style="list-style-type: none"> • H7 / H7 • PY21W
Fitting Position	Right
Left-hand / Right-hand Traffic	for right-hand traffic
Light Design	Halogen
Light Function	<ul style="list-style-type: none"> • with low beam • with position light • with indicator • with high beam • without daylight running light
Rated Voltage [V]	24
Supplementary Article/Supplementary Info 2	with bulbs
Vehicle Equipment	for vehicles with headlamp levelling (electric)

1L8 003 060-561
E1 7097

Headlamp, not suitable for headlamp leveller



Bulb Type	<ul style="list-style-type: none"> • T4W • R2 (Bilux)
Fitting Position	<ul style="list-style-type: none"> • Left • Right
Inspection Tag	E1 7097
Left-hand / Right-hand Traffic	for left-hand traffic
Light Function	<ul style="list-style-type: none"> • with low beam • with position light • with high beam
Mounting Type	Fitting
Rated Voltage [V]	12
Supplementary Article/Supplementary Info 2	without indicator lamp

Spare Parts

- 1 x 9FF 126 444-001 Bulb Socket, headlight
- 1 x 9GH 116 966-011 Cap, headlight

Accessories

- 
 1 x 8GD 002 088-131 Bulb
- 
 1 x 8GP 002 067-121 Bulb

Headlight

1L8 003 060-691
012788, E1 7144

H4 headlamp, not suitable for headlamp leveller



Bulb Type	<ul style="list-style-type: none"> • T4W • H4
Fitting Position	<ul style="list-style-type: none"> • Left • Right
Inspection Tag	E1 7144
Left-hand / Right-hand Traffic	for left-hand traffic
Light Design	Halogen
Light Function	<ul style="list-style-type: none"> • with low beam • with position light • with high beam
Mounting Type	Fitting
Rated Voltage [V]	12
Supplementary Article/Supplementary Info 2	without indicator lamp

Spare Parts

1 x 9GH 116 966-011 Cap, headlight

Accessories

 1 x 8GJ 002 525-131 Bulb, spotlight

 1 x 8GP 002 067-121 Bulb

1 x 9FF 126 444-001 Bulb Socket, headlight

1LH 354 987-071

Bulb Type	<ul style="list-style-type: none"> • H7 / H7 • PY21W
Fitting Position	Left
Left-hand / Right-hand Traffic	for left-hand traffic
Light Design	Halogen
Light Function	<ul style="list-style-type: none"> • with low beam • with position light • with indicator • with high beam • without daylight running light
Rated Voltage [V]	24
Supplementary Article/Supplementary Info 2	with bulbs
Vehicle Equipment	for vehicles with headlamp levelling (electric)

Headlight

1LH 354 987-081

Bulb Type	<ul style="list-style-type: none"> • H7 / H7 • PY21W
Fitting Position	Right
Left-hand / Right-hand Traffic	for left-hand traffic
Light Design	Halogen
Light Function	<ul style="list-style-type: none"> • with low beam • with position light • with indicator • with high beam • without daylight running light
Rated Voltage [V]	24
Supplementary Article/Supplementary Info 2	with bulbs
Vehicle Equipment	for vehicles with headlamp levelling (electric)

Headlight - Spotlight

1FE 005 478-011
012440, E1 34517, E1 44408

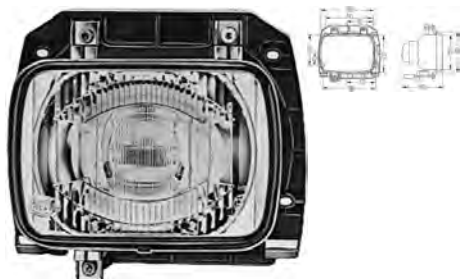

Bulb Type	H1
Depth [mm]	140
Fastening Type	Three-point mounting
Fitting Depth [mm]	133
Fitting Position	Left
Height [mm]	142
Illuminated Area [mm]	190 x 132
Inner Diameter [mm]	120
Inspection Tag	<ul style="list-style-type: none"> • E1 34517 • E1 44408
Light Design	Halogen
Light Function	with high beam
Mounting Type	Fitting
Rated Voltage [V]	<ul style="list-style-type: none"> • 12 • 24
Width [mm]	190

Accessories



1 x 8GH 002 089-133 Bulb

Headlight - Spotlight

1FE 005 478-021
E1 34517, 012441, E1 44408

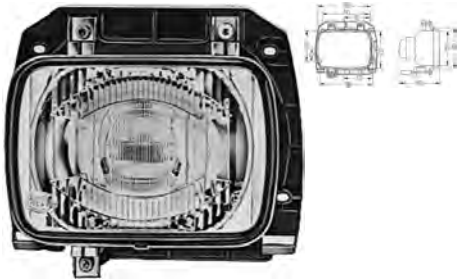

Bulb Type	H1
Depth [mm]	140
Fastening Type	Three-point mounting
Fitting Depth [mm]	133
Fitting Position	Right
Height [mm]	142
Illuminated Area [mm]	190 x 132
Inner Diameter [mm]	120
Inspection Tag	<ul style="list-style-type: none"> • E1 34517 • E1 44408
Light Design	Halogen
Light Function	<ul style="list-style-type: none"> • for main beam • with high beam
Mounting Type	Fitting
Rated Voltage [V]	<ul style="list-style-type: none"> • 12 • 24
Width [mm]	190

Accessories



1 x 8GH 002 089-133 Bulb

1FP 354 986-011

Bulb Type	H4
Fitting Position	Left
Rated Voltage [V]	24
Supplementary Article/Supplementary Info 2	with bulbs

1FP 354 986-021

Bulb Type	H4
Fitting Position	Right
Rated Voltage [V]	24
Supplementary Article/Supplementary Info 2	with bulbs

1NB 354 986-031

Bulb Type	<ul style="list-style-type: none"> • P21W • H4
Fitting Position	Left
Lens Colour	Yellow
Light Function	<ul style="list-style-type: none"> • with indicator • with high beam • with fog light
Rated Voltage [V]	24
Supplementary Article/Supplementary Info 2	with bulbs

Headlight - Spotlight

1NB 354 986-041

Bulb Type	<ul style="list-style-type: none"> • P21W • H4
Fitting Position	Right
Lens Colour	Yellow
Light Function	<ul style="list-style-type: none"> • with indicator • with high beam • with fog light
Rated Voltage [V]	24
Supplementary Article/Supplementary Info 2	with bulbs

1NB 354 986-051

Bulb Type	<ul style="list-style-type: none"> • H4 • PY21W
Fitting Position	Left
Lens Colour	White
Light Function	<ul style="list-style-type: none"> • with indicator • with high beam • with fog light
Rated Voltage [V]	24
Supplementary Article/Supplementary Info 2	with bulbs

1NB 354 986-061

Bulb Type	<ul style="list-style-type: none"> • H4 • PY21W
Fitting Position	Right
Lens Colour	White
Light Function	<ul style="list-style-type: none"> • with indicator • with high beam • with fog light
Rated Voltage [V]	24
Supplementary Article/Supplementary Info 2	with bulbs

1NB 354 986-071

Bulb Type	H3
Fitting Position	Left
Light Design	Halogen
Light Function	<ul style="list-style-type: none"> • with high beam • with fog light
Rated Voltage [V]	24
Supplementary Article/Supplementary Info 2	with bulbs

1NB 354 986-081

Bulb Type	H3
Fitting Position	Right
Light Design	Halogen
Light Function	<ul style="list-style-type: none"> • with high beam • with fog light
Rated Voltage [V]	24
Supplementary Article/Supplementary Info 2	with bulbs

Headlight - Worklight

1G4 004 480-001
015071

H3 work lamp

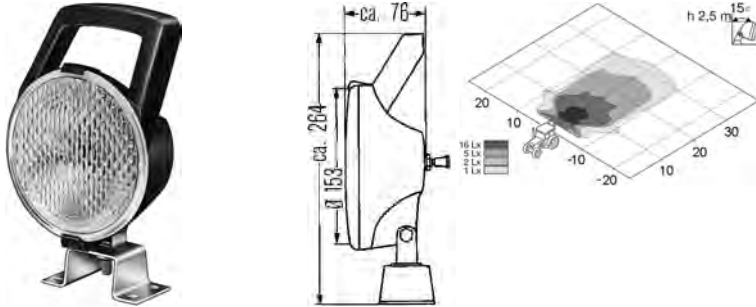

Bulb Type	H3
Depth [mm]	76
Diameter [mm]	153
Fitting Position	<ul style="list-style-type: none"> • Left • Right
Height [mm]	264
Housing Colour	Black
Illuminated Area [mm]	133
Inspection Tag	IP5K4K
Light Design	Halogen
Light Distribution	Short distance lighting
Mounting Type	<ul style="list-style-type: none"> • mounting • Bracket
Rated Voltage [V]	<ul style="list-style-type: none"> • 12 • 24
Reach [m]	30
Shape	Round
Vibration	without vibration damper

Spare Parts

 1 x 9XD 130 261-001 Base, worklight

Accessories

 1 x 8GH 002 090-133 Bulb

 1 x 8GH 002 090-251 Bulb

 1 x 8GH 002 090-271 Bulb

 1 x 8HG 004 806-001 Base, worklight

Housing, combination rearlight

9BG 130 945-001

E4 421, E4 23215, E4 377, E4 3880, E4 397

Body with central plug, left



Additionally required articles (article numbers)	<ul style="list-style-type: none"> • 9EL 122 689-021 • 9EL 122 689-051
Bulb Type	<ul style="list-style-type: none"> • P21W • R10W
Colour	Black
Fitting Position	Left
Inspection Tag	<ul style="list-style-type: none"> • E4 23215 • E4 377 • E4 3880 • E4 397 • E4 421

Accessories

 1 x 9EL 122 689-021 Lens, combination rearlight

 1 x 9EL 122 689-051 Lens, combination rearlight

 1 x 9GP 003 995-801 Vibration Damper

9BG 130 946-001

E4 23215, E4 377, E4 3880, E4 397, E4 421

Body with central plug, right (The existing number-plate cut-out in the body should be closed if not required with cover 9HB 126 601-001)



Additionally required articles (article numbers)	<ul style="list-style-type: none"> • 9EL 122 689-021 • 9EL 122 689-051
Bulb Type	<ul style="list-style-type: none"> • P21W • R10W
Colour	Black
Fitting Position	Right
Inspection Tag	<ul style="list-style-type: none"> • E4 23215 • E4 377 • E4 3880 • E4 397 • E4 421

Spare Parts

 1 x 9EL 122 689-051 Lens, combination rearlight

Accessories

 1 x 9EL 122 689-021 Lens, combination rearlight

 1 x 9GP 003 995-801 Vibration Damper

Housing, licence plate light

9BG 121 587-031
090511

Light housing with screw



Bulb Type	R10W
Inspection Tag	E1 22819
Supplementary Article/Supplementary Info	without lamp base
Supplementary Article/Supplementary Info 2	with screw

Insert, headlight

1A8 121 149-001
010070, E1 14559



Bulb Type	<ul style="list-style-type: none"> • T4W • R2 (Bilux)
Fitting Position	<ul style="list-style-type: none"> • Left • Right
Inspection Tag	E1 14559
Left-hand / Right-hand Traffic	for right-hand traffic
Light Function	<ul style="list-style-type: none"> • with low beam • with position light • with high beam
Supplementary Article/Supplementary Info 2	without carrying frame

1A8 121 150-001
E1 34495, 012065, E1 14551



Bulb Type	<ul style="list-style-type: none"> • T4W • H4
Fitting Position	<ul style="list-style-type: none"> • Left • Right
Inspection Tag	<ul style="list-style-type: none"> • E1 14551 • E1 34495
Left-hand / Right-hand Traffic	for right-hand traffic
Light Design	Halogen
Light Function	<ul style="list-style-type: none"> • with low beam • with position light • with high beam
Supplementary Article/Supplementary Info 2	without carrying frame

Insert, headlight

1BL 005 740-091
012449, E1 7414

Only for spare parts requirement



Bulb Type	<ul style="list-style-type: none"> • H1 • T4W
Diffusing Lens Type	Hardened diffusing lens
Fitting Position	Left
Height [mm]	142
Illuminated Area [mm]	190 x 132
Inspection Tag	E1 7414
Left-hand / Right-hand Traffic	for right-hand traffic
Light Design	<ul style="list-style-type: none"> • Halogen • DE
Light Function	<ul style="list-style-type: none"> • with low beam • with position light
Machining	Hardened
Mounting Type	Fitting
Rated Voltage [V]	<ul style="list-style-type: none"> • 12 • 24
Width [mm]	190

Accessories

	1 x 8GH 002 089-133 Bulb
	1 x 8GH 002 089-251 Bulb
	1 x 8GP 002 067-121 Bulb
	1 x 8GP 002 067-241 Bulb

Insert, headlight

1BL 005 740-101
E1 7414, 012450

Only for spare parts requirement



Bulb Type	<ul style="list-style-type: none"> • H1 • T4W
Diffusing Lens Type	Hardened diffusing lens
Fitting Position	Right
Height [mm]	142
Illuminated Area [mm]	190 x 132
Inspection Tag	E1 7414
Left-hand / Right-hand Traffic	for right-hand traffic
Light Design	<ul style="list-style-type: none"> • Halogen • DE
Light Function	<ul style="list-style-type: none"> • with low beam • with position light
Machining	Hardened
Mounting Type	Fitting
Rated Voltage [V]	<ul style="list-style-type: none"> • 12 • 24
Width [mm]	190

Accessories

	1 x 8GH 002 089-133 Bulb
	1 x 8GH 002 089-251 Bulb
	1 x 8GP 002 067-121 Bulb
	1 x 8GP 002 067-241 Bulb



Lens, combination rearlight

9EL 122 689-021

E4 4033, E4 3134, E4 3880, E4 23215, E4 377, 092326, E4 421, E4 397

Lens for tail, reflex-reflector, stop, flasher, reversing, rear fog light



Bulb Type	<ul style="list-style-type: none"> • P21W • R10W 	<p>Accessories</p>  1 x 9BG 130 945-001 Housing, combination rearlight  1 x 9BG 130 946-001 Housing, combination rearlight  1 x 9GP 003 995-801 Vibration Damper
Fitting Position	<ul style="list-style-type: none"> • Left • Right 	
Inspection Tag	<ul style="list-style-type: none"> • E4 23215 • E4 3134 • E4 377 • E4 3880 • E4 397 • E4 4033 • E4 421 	
Light Function	<ul style="list-style-type: none"> • with reverse light • with reflector • with tail light • with indicator • with stop light • with fog taillight 	
Supplementary Article/Supplementary Info	without lamp base	

Lens, combination rearlight

9EL 122 689-051

E4 4033, E4 377, E4 421, E4 397, E4 23215

Lens for tail, reflex-reflector, stop, flasher, reversing light



Bulb Type	<ul style="list-style-type: none"> • P21W • R10W
Fitting Position	<ul style="list-style-type: none"> • Left • Right
Inspection Tag	<ul style="list-style-type: none"> • E4 23215 • E4 377 • E4 397 • E4 4033 • E4 421
Light Function	<ul style="list-style-type: none"> • with reverse light • with reflector • with tail light • with indicator • with stop light
Supplementary Article/Supplementary Info	without lamp base

Accessories

	1 x 9BG 130 945-001 Housing, combination rearlight
	1 x 9BG 130 946-001 Housing, combination rearlight
	1 x 9GP 003 995-801 Vibration Damper

9EL 147 747-001

E1 264

Lens with screws



Bulb Type	<ul style="list-style-type: none"> • P21W • R10W
Fitting Position	<ul style="list-style-type: none"> • Left • Right
Inspection Tag	E1 264
Light Function	<ul style="list-style-type: none"> • with tail light • with indicator • with stop light • with number plate light
Supplementary Article/Supplementary Info	without lamp base
Supplementary Article/Supplementary Info 2	with screws

Lens, combination rearlight

9EL 152 889-001

092925, E4 9810, E4 9808, E4 3178, E4 4060

Lens with screws



Bulb Type	<ul style="list-style-type: none"> • P21W • R5W
Fitting Position	<ul style="list-style-type: none"> • Left • Right
Inspection Tag	<ul style="list-style-type: none"> • E4 3178 • E4 4060 • E4 9808 • E4 9810
Light Function	<ul style="list-style-type: none"> • with reverse light • with tail light • with indicator • with stop light • with fog taillight
Supplementary Article/Supplementary Info	without lamp base
Supplementary Article/Supplementary Info 2	with screws

Lens, marker lamp

9EL 132 215-011

E1 31407

Bulb Type	T4W
Fitting Position	Lateral Mounting
Inspection Tag	E1 31407
Lens Colour	Red
Supplementary Article/Supplementary Info	without lamp base
Supplementary Article/Supplementary Info 2	with screws

Light - Combination Rearlight

2SD 003 167-531
E1 264



Bulb Type	<ul style="list-style-type: none"> • P21W • R10W
Fitting Position	Left
Housing Colour	Black
Inspection Tag	E1 264
Light Function	<ul style="list-style-type: none"> • with tail light • with indicator • with stop light
Mounting Type	<ul style="list-style-type: none"> • mounting • Fitting
Rated Voltage [V]	<ul style="list-style-type: none"> • 12 • 24
Supplementary Article/Supplementary Info	with lamp base

Spare Parts



1 x 9EL 147 747-001 Lens, combination rearlight

1 x 9GD 087 883-355 Gasket / Seal

Accessories



1 x 8GA 002 071-131 Bulb

1 x 8GA 002 071-251 Bulb

2 x 8GA 002 073-121 Bulb

2 x 8GA 002 073-241 Bulb

1 x 9GP 003 995-801 Vibration Damper

Light - Combination Rearlight

2SD 003 167-541
E1 264



Bulb Type	<ul style="list-style-type: none"> • P21W • R10W
Fitting Position	Right
Housing Colour	Black
Inspection Tag	E1 264
Light Function	<ul style="list-style-type: none"> • with tail light • with indicator • with stop light
Mounting Type	<ul style="list-style-type: none"> • mounting • Fitting
Rated Voltage [V]	<ul style="list-style-type: none"> • 12 • 24
Supplementary Article/Supplementary Info	with lamp base

Spare Parts

	1 x 9EL 147 747-001 Lens, combination rearlight
	1 x 9GD 087 883-355 Gasket / Seal

Accessories

	1 x 8GA 002 071-131 Bulb
	1 x 8GA 002 071-251 Bulb
	2 x 8GA 002 073-121 Bulb
	2 x 8GA 002 073-241 Bulb
	1 x 9GP 003 995-801 Vibration Damper

Light - Combination Rearlight

2VD 008 204-051

E4 9810, 026193, E4 4060, E4 9808, E4 3178

Combination rear lamp with numberplate, rear fog, reversing and end-outline marker light, with reflex-reflector and centre plug, left

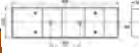

1 BL	gelb	1 BL	yellow	1 BL	geel	1 BL	giallo	1 BL	helkainen
2 SKUR/SMLR	schwarz	2 BKUR/SMLR	black	2 SKUR/SMLR	zwart	2 SKUR/SMLR	nere	2 SKUR/SMLR	musta
3 B	rot	3 B	rot	3 B	rood	3 B	roșu	3 B	punainen
4 NES	blau	4 NES	blue	4 NES	blauw	4 NES	blu	4 NES	sininen
5 ZR	grün	5 ZR	green	5 ZR	groen	5 ZR	verde	5 ZR	vihreä
6 ---	nicht belegt	6 ---	not used	6 ---	not gebruikt	6 ---	senza funzione	6 ---	vapaa
7 ---	nicht belegt	7 ---	not used	7 ---	not gebruikt	7 ---	senza funzione	7 ---	vapaa
8 Masse	weiß	8 Ground	white	8 Masse	wit	8 Masse	bianco	8 Maa	valkoinen

1 BL	ámbær	1 BL	gal	1 BL	gelb	1 BL	gelb	1 BL	orange	1 BL	span
2 SKUR/SMLR	negro	2 SKUR/SMLR	roșu	2 SKUR/SMLR	schwarz	2 SKUR/SMLR	brunt	2 SKUR/SMLR	noir	2 SKUR/SMLR	czarny
3 B	rojo	3 B	roșu	3 B	rot	3 B	roșu	3 B	rouge	3 B	czernony
4 NES	azul	4 NES	gal	4 NES	blau	4 NES	blau	4 NES	bleu	4 NES	niebieski
5 ZR	gris	5 ZR	grün	5 ZR	grün	5 ZR	grün	5 ZR	gris	5 ZR	szary
6 ---	libre	6 ---	ikke forbrukt	6 ---	ikke forbrukt	6 ---	ikke forbrukt	6 ---	libre	6 ---	nie używany
7 ---	libre	7 ---	ikke forbrukt	7 ---	ikke forbrukt	7 ---	ikke forbrukt	7 ---	libre	7 ---	nie używany
8 Masse	blanco	8 Masse	hvít	8 Masse	weiß	8 Masse	hvít	8 Masse	blanc	8 Masse	biały

Bulb Type	<ul style="list-style-type: none"> P21W R5W
Fitting Position	<ul style="list-style-type: none"> Left Right
Height [mm]	130
Housing Colour	Black
Inspection Tag	<ul style="list-style-type: none"> E4 3178 E4 4060 E4 9808 E4 9810
Light Function	<ul style="list-style-type: none"> with reverse light with reflector with tail light with marker lamp with indicator with stop light with number plate light with fog taillight
Mounting Type	mounting
Plug Type ID	8-polig
Rated Voltage [V]	24
Supplementary Article/Supplementary Info	with lamp base
Width [mm]	464

Spare Parts	1 x 9EL 152 889-001 Lens, combination rearlight
Accessories	3 x 8GA 002 071-121 Bulb 3 x 8GA 002 071-241 Bulb 4 x 8GA 002 073-121 Bulb 4 x 8GA 002 073-241 Bulb

Light - Combination Rearlight

2VD 008 204-071

E4 9810, E4 3178, 027694, E4 4060, E4 9808

Combination rearlight with numberplate, rear fog, reversing, end-outline marker light, side-marker lamp, with reflex-reflector, marker reflex-reflector and centre plug, left

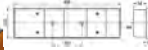
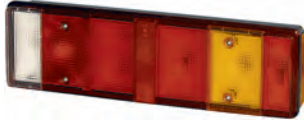

1 BL	gelb	1 BL	yellow	1 BL	gelb	1 BL	gelb	1 BL	heikkinen
2 SK/U/R/SMLR	schwarz	2 BK/U/R/SMLR	black	2 SK/U/R/SMLR	švart	2 SK/U/R/SMLR	noir	2 SK/U/R/SMLR	musta
3 B	rot	3 B	rot	3 B	rood	3 B	rojo	3 B	punainen
4 NES	blau	4 NES	blue	4 NES	blauw	4 NES	azul	4 NES	sininen
5 ZR	grün	5 ZR	green	5 ZR	groen	5 ZR	verde	5 ZR	vihreä
6 ---	nicht benutzt	6 ---	not used	6 ---	niets gebruikt	6 ---	nie gebruikt	6 ---	ei käytetty
7 ---	nicht benutzt	7 ---	not used	7 ---	niets gebruikt	7 ---	nie gebruikt	7 ---	ei käytetty
8 Masse	weiß	8 Grund	white	8 Masse	wit	8 Grund	valkoinen	8 Maa	valkoinen

1 BL	ámbar	1 BL	gul	1 BL	gul	1 BL	giall	1 BL	orange	1 BL	orá
2 SK/U/R/SMLR	negro	2 SK/U/R/SMLR	sort	2 SK/U/R/SMLR	sort	2 SK/U/R/SMLR	noir	2 SK/U/R/SMLR	rojo	2 SK/U/R/SMLR	czerny
3 B	rojo	3 B	rojo	3 B	rojo	3 B	rojo	3 B	rojo	3 B	czerny
4 NES	azul	4 NES	blau	4 NES	blau	4 NES	blau	4 NES	blau	4 NES	niebieski
5 ZR	grün	5 ZR	grün	5 ZR	grün	5 ZR	grün	5 ZR	grün	5 ZR	zeleny
6 ---	libre	6 ---	libre	6 ---	libre	6 ---	libre	6 ---	libre	6 ---	nie używany
7 ---	libre	7 ---	libre	7 ---	libre	7 ---	libre	7 ---	libre	7 ---	nie używany
8 Masse	blanco	8 Maa	valkoinen	8 Grund	valkoinen	8 Masse	blanc	8 Grund	valkoinen	8 Maa	valkoinen

Bulb Type	<ul style="list-style-type: none"> P21W R5W
Fitting Position	Left
Height [mm]	130
Housing Colour	Black
Inspection Tag	<ul style="list-style-type: none"> E4 3178 E4 4060 E4 9808 E4 9810
Light Function	<ul style="list-style-type: none"> with reverse light with reflector with tail light with side marker light with marker lamp with indicator with stop light with number plate light with fog taillight
Mounting Type	mounting
Plug Type ID	8-polig
Rated Voltage [V]	24
Supplementary Article/Supplementary Info	with lamp base
Width [mm]	464

Spare Parts	 1 x 9EL 152 889-001 Lens, combination rearlight
Accessories	 3 x 8GA 002 071-121 Bulb  3 x 8GA 002 071-241 Bulb  4 x 8GA 002 073-121 Bulb  4 x 8GA 002 073-241 Bulb

Light - Combination Rearlight

2VD 008 204-251

E4 4060, E4 3178, E4 9810, E4 9808

Combination rear lamp with numberplate, rear fog, reversing, end-outline marker light, side-marker lamp, with reflex-reflector and marker reflex-reflector, left

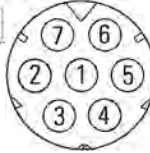
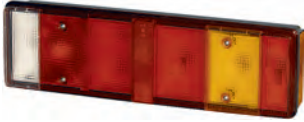

1 Masse	weiß	1 Ground	white	1 Masse	weiß	1 Masse	blanco
2 SKVUR/SMUR	braun	2 SKVUR/SMUR	brown	2 SKVUR/SMUR	brun	2 SKVUR/SMUR	marroño
3 ZR	gelb	3 ZR	yellow	3 ZR	giallo	3 ZR	giallo
4 BL	grün	4 BL	green	4 BL	verde	4 BL	verde
5 B	rot	5 B	red	5 B	rojo	5 B	rojo
6 NES	blau	6 NES	blue	6 NES	azul	6 NES	azul
7 —	nicht belegt	7 —	not used	7 —	no ocupado	7 —	no ocupado

1 Maa	valkoinen	1 Masa	blanco	1 Jord	hvit	1 Sbi	hvit	1 Järpanslutning	vit	1 Masse	blanc	1 Ground	bianco
2 SKVUR/SMUR	ruskea	2 SKVUR/SMUR	marroñ	2 SKVUR/SMUR	brun	2 SKVUR/SMUR	brun	2 SKVUR/SMUR	brun	2 SKVUR/SMUR	marroñ	2 SKVUR/SMUR	brun
3 ZR	valkoinen	3 ZR	ambra	3 ZR	gul	3 ZR	gul	3 ZR	gul	3 ZR	orange	3 ZR	giallo
4 BL	vihreä	4 BL	verde	4 BL	grønn	4 BL	grøn	4 BL	grønn	4 BL	vert	4 BL	zöld
5 B	punainen	5 B	rojo	5 B	red	5 B	red	5 B	red	5 B	rojo	5 B	rojo
6 NES	sininen	6 NES	szul	6 NES	blå	6 NES	blå	6 NES	blå	6 NES	niebieski	6 NES	niebieski
7 —	vapaa	7 —	libre	7 —	ikke i bruk	7 —	ikke tilgjengelig	7 —	ej kopplad	7 —	libre	7 —	nik vyzivny

Bulb Type	<ul style="list-style-type: none"> • P21W • R5W
Fitting Position	Left
Height [mm]	134
Housing Colour	Black
Inspection Tag	<ul style="list-style-type: none"> • E4 3178 • E4 4060 • E4 9808 • E4 9810
Light Function	<ul style="list-style-type: none"> • with reverse light • with reflector • with tail light • with side marker light • with marker lamp • with indicator • with stop light • with number plate light • with fog taillight
Mounting Type	mounting
Plug Type ID	7-polig
Rated Voltage [V]	<ul style="list-style-type: none"> • 12 • 24
Supplementary Article/Supplementary Info	with lamp base
Width [mm]	468

Spare Parts

1 x 9EL 152 889-001 Lens, combination rearlight

Accessories

3 x 8GA 002 071-121 Bulb

1 x 8GA 002 071-131 Bulb

3 x 8GA 002 071-241 Bulb

1 x 8GA 002 071-251 Bulb

4 x 8GA 002 073-121 Bulb

4 x 8GA 002 073-241 Bulb

Light - Combination Rearlight

2VP 003 567-111

E4 377, E4 3134, E4 3880, E4 397, E4 421, E4 23215



Bulb Type	<ul style="list-style-type: none"> • P21W • R10W
Fitting Position	Left
Inspection Tag	<ul style="list-style-type: none"> • E4 23215 • E4 3134 • E4 377 • E4 3880 • E4 397 • E4 421
Light Function	<ul style="list-style-type: none"> • with reverse light • with reflector • with tail light • with indicator • with stop light • with high beam
Rated Voltage [V]	<ul style="list-style-type: none"> • 12 • 24

Spare Parts

 1 x 9EL 122 689-021 Lens, combination rearlight

Accessories

	1 x 8GA 002 071-131 Bulb
	1 x 8GA 002 071-251 Bulb
	4 x 8GA 002 073-121 Bulb
	4 x 8GA 002 073-241 Bulb
	1 x 9GP 003 995-801 Vibration Damper

Light - Combination Rearlight

2VP 003 567-121

E4 3880, E4 3134, E4 421, E4 397, E4 377, E4 23215



Bulb Type	<ul style="list-style-type: none"> • P21W • R10W
Fitting Position	Right
Inspection Tag	<ul style="list-style-type: none"> • E4 23215 • E4 3134 • E4 377 • E4 3880 • E4 397 • E4 421
Light Function	<ul style="list-style-type: none"> • with reverse light • with reflector • with tail light • with indicator • with stop light • with high beam
Rated Voltage [V]	<ul style="list-style-type: none"> • 12 • 24

Spare Parts

 1 x 9EL 122 689-021 Lens, combination rearlight

Accessories

	1 x 8GA 002 071-131 Bulb
	1 x 8GA 002 071-251 Bulb
	4 x 8GA 002 073-121 Bulb
	4 x 8GA 002 073-241 Bulb
	1 x 9GP 003 995-801 Vibration Damper

Light - Combination Rearlight

2VP 008 204-041

E4 9810, 027692, E4 3178, E4 4060, E4 9808

Combination rear lamp with rear fog, reversing and end-outline marker light, with reflex-reflector and centre plug, left/right _

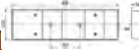

1 BL	gelb	1 BL	yellow	1 BL	geel	1 BL	geel	1 BL	keltainen
2 SKUR/SMLR	schwarz	2 BKUR/SMLR	black	2 SKUR/SMLR	zwart	2 SKUR/SMLR	niere	2 SKUR/SMLR	musta
3 B	rot	3 B	rot	3 B	rood	3 B	rood	3 B	punainen
4 NES	blau	4 NES	blue	4 NES	blauw	4 NES	blau	4 NES	sininen
5 ZR	grün	5 ZR	grey	5 ZR	grijs	5 ZR	grün	5 ZR	harmaa
6 ---	nicht belegt	6 ---	not used	6 ---	niet gebruikt	6 ---	handa funktion	6 ---	vapaa
7 ---	nicht belegt	7 ---	not used	7 ---	niet gebruikt	7 ---	handa funktion	7 ---	vapaa
8 Masse	weiß	8 Ground	white	8 Masse	wit	8 Masse	valkio	8 Maa	valkoinen

1 BL	ámbær	1 BL	gel	1 BL	gel	1 BL	orange	1 BL	szék
2 SKUR/SMLR	negro	2 SKUR/SMLR	schwarz	2 SKUR/SMLR	schwarz	2 SKUR/SMLR	noir	2 SKUR/SMLR	czerny
3 B	rojo	3 B	rot	3 B	rood	3 B	rouge	3 B	czerny
4 NES	azul	4 NES	blau	4 NES	blau	4 NES	bleu	4 NES	niebieski
5 ZR	grün	5 ZR	grün	5 ZR	grün	5 ZR	grün	5 ZR	szary
6 ---	grün	6 ---	grün	6 ---	grün	6 ---	grün	6 ---	nie używany
7 ---	libre	7 ---	libre	7 ---	libre	7 ---	libre	7 ---	nie używany
8 Masse	blanco	8 Masse	blanc	8 Masse	blanc	8 Masse	blanc	8 Masse	biały

Bulb Type	• P21W • R5W
Fitting Position	• Left • Right
Height [mm]	130
Housing Colour	Black
Inspection Tag	• E4 3178 • E4 4060 • E4 9808 • E4 9810
Light Function	• with reverse light • with reflector • with tail light • with marker lamp • with indicator • with stop light • with fog taillight
Mounting Type	mounting
Plug Type ID	6-polig
Rated Voltage [V]	24
Supplementary Article/Supplementary Info	with lamp base
Width [mm]	464

Spare Parts	1 x 9EL 152 889-001 Lens, combination rearlight
Accessories	2 x 8GA 002 071-121 Bulb
	2 x 8GA 002 071-241 Bulb
	4 x 8GA 002 073-121 Bulb
	4 x 8GA 002 073-241 Bulb

Light - Combination Rearlight

2VP 008 204-061

E4 4060, E4 9808, 027693, E4 3178, E4 9810

Combination rear lamp with rear fog, reversing, end-outline marker light, side-marker lamp, with reflex-reflector, marker reflex-reflector and centre plug, left/right

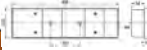
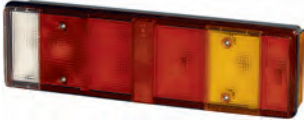

1 BL	gelb	1 BL	yellow	1 BL	gelb	1 BL	gelb	1 BL	keltainen
2 SK/U/R/SMLR	schwarz	2 BK/U/R/SMLR	black	2 SK/U/R/SMLR	švart	2 SK/U/R/SMLR	noir	2 SK/U/R/SMLR	musta
3 B	rot	3 B	rot	3 B	rouge	3 B	crimson	3 B	punainen
4 NES	blau	4 NES	blue	4 NES	bleu	4 NES	bleu	4 NES	sininen
5 ZR	grün	5 ZR	green	5 ZR	grün	5 ZR	vert	5 ZR	vihreä
6	nicht benutzt	6	not used	6	ne pas utilisé	6	not used	6	ei käytetty
7	nicht benutzt	7	not used	7	ne pas utilisé	7	not used	7	ei käytetty
8 Masse	weiß	8 Grund	white	8 Masse	vil	8 Masse	blanc	8 Maa	valkoinen

1 BL	ámbær	1 BL	gul	1 BL	gul	1 BL	gul	1 BL	orange	1 BL	szety
2 SK/U/R/SMLR	negro	2 SK/U/R/SMLR	sort	2 SK/U/R/SMLR	sort	2 SK/U/R/SMLR	noir	2 SK/U/R/SMLR	noir	2 SK/U/R/SMLR	czerny
3 B	rojo	3 B	red	3 B	rouge	3 B	rouge	3 B	orange	3 B	czerny
4 NES	azul	4 NES	bleu	4 NES	bleu	4 NES	bleu	4 NES	bleu	4 NES	niebieski
5 ZR	grün	5 ZR	grün	5 ZR	grün	5 ZR	grün	5 ZR	grün	5 ZR	szary
6	libre	6	libre	6	libre	6	libre	6	libre	6	nie używany
7	libre	7	libre	7	libre	7	libre	7	libre	7	nie używany
8 Masse	bianco	8	libre	8	libre	8	libre	8	libre	8	nie używany

Bulb Type	<ul style="list-style-type: none"> P21W R5W
Fitting Position	<ul style="list-style-type: none"> Left Right
Height [mm]	130
Housing Colour	Black
Inspection Tag	<ul style="list-style-type: none"> E4 3178 E4 4060 E4 9808 E4 9810
Light Function	<ul style="list-style-type: none"> with reverse light with reflector with tail light with side marker light with marker lamp with indicator with stop light with fog taillight
Mounting Type	mounting
Plug Type ID	6-polig
Rated Voltage [V]	24
Supplementary Article/Supplementary Info	with lamp base
Width [mm]	464

Spare Parts	1 x 9EL 152 889-001 Lens, combination rearlight
Accessories	2 x 8GA 002 071-121 Bulb 2 x 8GA 002 071-241 Bulb 4 x 8GA 002 073-121 Bulb 4 x 8GA 002 073-241 Bulb

Light - Combination Rearlight

2VP 008 204-241

E4 3178, E4 9808, E4 4060, E4 9810

Combination rear lamp with rear fog, reversing, end-outline marker light, side-marker lamp, with reflex-reflector and marker reflex-reflector, left/right

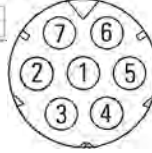
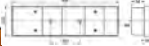
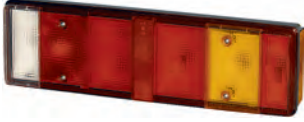

1 Masse	weiß	1 Ground	white	1 Masse	weiß	1 Masse	blanco
2 SKVUR/SMLR	braun	2 SKVUR/SMLR	brown	2 SKVUR/SMLR	brun	2 SKVUR/SMLR	marroño
3 ZR	gelb	3 ZR	yellow	3 ZR	gult	3 ZR	gult
4 BL	grün	4 BL	green	4 BL	grün	4 BL	verde
5 B	rot	5 B	red	5 B	rot	5 B	rojo
6 NES	blau	6 NES	blue	6 NES	blau	6 NES	blu
7 —	nicht belegt	7 —	not used	7 —	nicht genutzt	7 —	senza funzione

1 Maa	valkoinen	1 Masa	blanco	1 Jarda	ivrit	1 Jarda	ivrit	1 Jarda	ivrit	1 Masse	blanc	1 Ground	blau
2 SKVUR/SMLR	ruskea	2 SKVUR/SMLR	marroñ	2 SKVUR/SMLR	brun	2 SKVUR/SMLR	brun	2 SKVUR/SMLR	brun	2 SKVUR/SMLR	marroñ	2 SKVUR/SMLR	brun
3 ZR	valkoinen	3 ZR	ambas	3 ZR	gult	3 ZR	gult	3 ZR	gult	3 ZR	orange	3 ZR	gult
4 BL	vihreä	4 BL	verde	4 BL	grün	4 BL	grün	4 BL	grün	4 BL	vert	4 BL	zöld
5 B	punainen	5 B	rojo	5 B	red	5 B	red	5 B	red	5 B	czarny	5 B	czarny
6 NES	sininen	6 NES	szul	6 NES	blu	6 NES	blu	6 NES	blu	6 NES	nieszy	6 NES	nieszy
7 —	vapaa	7 —	libre	7 —	ikke t. käyt.	7 —	ikke t. käyt.	7 —	ej koppad	7 —	libre	7 —	nik. używany

Bulb Type	<ul style="list-style-type: none"> P21W R5W
Fitting Position	Right
Height [mm]	134
Housing Colour	Black
Inspection Tag	<ul style="list-style-type: none"> E4 3178 E4 4060 E4 9808 E4 9810
Light Function	<ul style="list-style-type: none"> with reverse light with reflector with tail light with side marker light with marker lamp with indicator with stop light with fog taillight
Mounting Type	mounting
Plug Type ID	7-polig
Rated Voltage [V]	<ul style="list-style-type: none"> 12 24
Supplementary Article/Supplementary Info	with lamp base
Width [mm]	468

Spare Parts	1 x 9EL 152 889-001 Lens, combination rearlight
Accessories	2 x 8GA 002 071-121 Bulb 1 x 8GA 002 071-131 Bulb 2 x 8GA 002 071-241 Bulb 1 x 8GA 002 071-251 Bulb 4 x 8GA 002 073-121 Bulb 4 x 8GA 002 073-241 Bulb

Light - Licence Plate Light

2KA 001 388-051
E1 22902





Bulb Type	C5W
Fitting Position	<ul style="list-style-type: none"> • Left • Right
Inspection Tag	E1 22902
Light Function	with number plate light
Mounting Type	Fitting
Rated Voltage [V]	24
Supplementary Article/Supplementary Info	with lamp base

2KA 003 389-081
E1 22819



Bulb Type	P21W
Colour	Black
Fitting Position	<ul style="list-style-type: none"> • Left • Right
Inspection Tag	E1 22819
Light Function	with number plate light
Mounting Type	<ul style="list-style-type: none"> • mounting • PG-fastening
Supplementary Article/Supplementary Info	with lamp base

Accessories

-  1 x 8GA 002 071-251 Bulb
-  1 x 8GA 002 071-271 Bulb

Spare Parts



1 x 9BG 121 587-031 Housing, licence plate light

Light - Marker Lamp

2XS 005 020-041
E1 31407, 028024

End-outline marker lamp (red)

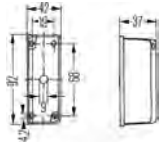

Bulb Type	T4W
Fitting Position	Lateral Mounting
Inspection Tag	E1 31407
Lens Colour	Red/Black
Light Function	with marker lamp mounting
Rated Voltage [V]	24
Supplementary Article/Supplementary Info	with lamp base

Spare Parts

1 x 9EL 132 215-011 Lens, marker lamp

Accessories

	1 x 8GP 002 067-121 Bulb
	1 x 8GP 002 067-241 Bulb

Light - Position Light

2PF 354 985-011

Fitting Position	Front
Lens Colour	White
Light Function	with position light
Rated Voltage [V]	24
Supplementary Article/Supplementary Info	without bulb

2PF 354 985-021

Fitting Position	Front
Lens Colour	White
Light Function	with position light
Supplementary Article/Supplementary Info	without bulb

Light - Side Marker Light

2PS 354 985-001

Lens Colour	Yellow
Light Design	LED
Light Function	with side marker light

Light - Indicator



2BA 005 603-001
E1 42748, 021168

Flasher lamp, for front mounting



Bulb Type	P21W
Fitting Position	<ul style="list-style-type: none"> • Left • Right • Front
Inspection Tag	E1 42748
Lens Colour	Yellow
Light Function	with indicator
Mounting Type	Fitting
Rated Voltage [V]	24
Supplementary Article/Supplementary Info	with lamp base

Accessories

	1 x 8GA 002 073-121 Bulb
	1 x 8GA 002 073-241 Bulb

2BA 007 839-001
021309, E12 6101



Bulb Type	P21W
Fitting Position	<ul style="list-style-type: none"> • Left • Right
Inspection Tag	E12 6101
Lens Colour	Yellow
Light Function	with indicator
Mounting Type	mounting
Rated Voltage [V]	24
Supplementary Article/Supplementary Info	with lamp base

Light - Indicator

2BA 007 840-001
021310, E12 6069





Bulb Type	P21W
Fitting Position	<ul style="list-style-type: none"> • Left • Right
Inspection Tag	E12 6069
Lens Colour	Yellow
Light Function	with indicator
Mounting Type	Fitting
Rated Voltage [V]	24
Supplementary Article/Supplementary Info	with lamp base

2BM 006 692-011
021253, E1 52621

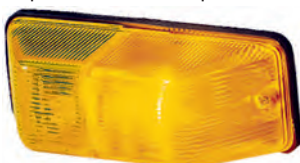
Repeater flasher lamp, left



Bulb Type	P21W
Fitting Position	<ul style="list-style-type: none"> • Left • Lateral Mounting
Inspection Tag	E1 52621
Lens Colour	Yellow
Light Function	with indicator
Mounting Type	mounting
Rated Voltage [V]	12
Supplementary Article/Supplementary Info	with lamp base

Accessories	
	1 x 8GA 002 073-121 Bulb
	1 x 8GA 002 073-241 Bulb

Light - Indicator



2BM 006 692-021
021254, E1 52621

Repeater flasher lamp, right



Bulb Type	P21W
Fitting Position	<ul style="list-style-type: none"> • Right • Lateral Mounting
Inspection Tag	E1 52621
Lens Colour	Yellow
Light Function	with indicator
Mounting Type	mounting
Rated Voltage [V]	<ul style="list-style-type: none"> • 12 • 24
Supplementary Article/Supplementary Info	with lamp base

Accessories

	1 x 8GA 002 073-121 Bulb
	1 x 8GA 002 073-241 Bulb



MAN.....50

Manufacturer - Model	Power	Displ.	Year of Constr.	Remark	Part Number	Page
MAN - Cab-over Trucks						07/86→05/94
19.322 U, 19.322 UL, 19.322 ULL	235 kW		02/90→05/94	T4W / H4; Left / Right; Number of light functions: 3; 12 V / 24 V	1AG 003 434-211 Headlight	10
19.372 U, 19.372 ULL	272 kW		02/90→05/94	H3; Depth [mm]: 76; Left / Right; Short distance lighting; 12 V / 24 V	1G4 004 480-001 Worklight	25
19.422 U, 19.422 ULL	309 kW		02/90→05/94			
26.322 UNL, 26.322 UNLL	235 kW		09/90→05/94	10/90→; →04/93; H3; Fitting Depth [mm]: 89; Left / Right; Transparent; Number of light functions: 1; + H 166 mm; 12 V / 24 V	1NE 006 300-051 Fog Light	7
26.372 UNL, 26.372 UNLL	272 kW		09/90→05/94	P21W; Left / Right; Yellow; Number of light functions: 1; with lamp base	2BA 007 840-001 Indicator	47
26.422 UNL, 26.422 UNLL	309 kW		09/90→05/94	→12/91; P21W; Left / Right; Number of light functions: 1; with lamp base	2KA 003 389-081 Licence Plate Light	44
				T4W; Lateral Mounting; Red/Black; Number of light functions: 1; with lamp base	2XS 005 020-041 Marker Lamp	45
				→12/91; R10W; without lamp base; with screw	9BG 121 587-031 Housing, licence plate light	27
				→12/91; Additionally required articles (article numbers): 9EL 122 689-021 / 9EL 122 689-051; P21W / R10W; Left	9BG 130 945-001 Housing, combination rearlight	26
				→12/91; Additionally required articles (article numbers): 9EL 122 689-021 / 9EL 122 689-051; P21W / R10W; Right	9BG 130 946-001 Housing, combination rearlight	26
				→12/91; P21W / R10W; Left / Right; with reverse light / with reflector / with tail light / with indicator / with stop light / with fog taillight; Number of light functions: 6; without lamp base	9EL 122 689-021 Lens, combination rearlight	31
				→12/91; P21W / R10W; Left / Right; with reverse light / with reflector / with tail light / with indicator / with stop light; Number of light functions: 5; without lamp base	9EL 122 689-051 Lens, combination rearlight	32
				T4W; Lateral Mounting; Red; without lamp base; with screws	9EL 132 215-011 Lens, marker lamp	33
				H4; Left / Right; for right-hand traffic	9ES 120 743-001 Diffusing Lens, headlight	4
19.332 U, 19.322 UL, 19.322 ULL	243 kW		07/86→02/90	T4W / H4; Left / Right; Number of light functions: 3; 12 V / 24 V	1AG 003 434-211 Headlight	10
24.332 UNL, 24.332 UNLL	243 kW		10/86→02/90	H3; Depth [mm]: 76; Left / Right; Short distance lighting; 12 V / 24 V	1G4 004 480-001 Worklight	25
24.362 UNL, 24.362 UNLL	265 kW		10/86→02/90	P21W; Left / Right; Yellow; Number of light functions: 1; with lamp base	2BA 007 840-001 Indicator	47
				P21W; Left / Right; Number of light functions: 1; with lamp base	2KA 003 389-081 Licence Plate Light	44
				T4W; Lateral Mounting; Red/Black; Number of light functions: 1; with lamp base	2XS 005 020-041 Marker Lamp	45
				R10W; without lamp base; with screw	9BG 121 587-031 Housing, licence plate light	27
				Additionally required articles (article numbers): 9EL 122 689-021 / 9EL 122 689-051; P21W / R10W; Left	9BG 130 945-001 Housing, combination rearlight	26
				Additionally required articles (article numbers): 9EL 122 689-021 / 9EL 122 689-051; P21W / R10W; Right	9BG 130 946-001 Housing, combination rearlight	26
				P21W / R10W; Left / Right; with reverse light / with reflector / with tail light / with indicator / with stop light / with fog taillight; Number of light functions: 6; without lamp base	9EL 122 689-021 Lens, combination rearlight	31
				P21W / R10W; Left / Right; with reverse light / with reflector / with tail light / with indicator / with stop light; Number of light functions: 5; without lamp base	9EL 122 689-051 Lens, combination rearlight	32
				T4W; Lateral Mounting; Red; without lamp base; with screws	9EL 132 215-011 Lens, marker lamp	33
				H4; Left / Right; for right-hand traffic	9ES 120 743-001 Diffusing Lens, headlight	4
19.362 U, 19.362 UL, 19.362 ULL	265 kW		07/86→01/91	T4W / H4; Left / Right; Number of light functions: 3; 12 V / 24 V	1AG 003 434-211 Headlight	10
24.322 UNL, 24.322 UNLL	235 kW		02/90→12/90	H3; Depth [mm]: 76; Left / Right; Short distance lighting; 12 V / 24 V	1G4 004 480-001 Worklight	25
24.372 UNL, 24.372 UNLL	272 kW		02/90→12/90			
24.422 UNL, 24.422 UNLL	309 kW		02/90→12/90	10/90→; H3; Fitting Depth [mm]: 89; Left / Right; Transparent; Number of light functions: 1; + H 166 mm; 12 V / 24 V	1NE 006 300-051 Fog Light	7
				P21W; Left / Right; Yellow; Number of light functions: 1; with lamp base	2BA 007 840-001 Indicator	47
				P21W; Left / Right; Number of light functions: 1; with lamp base	2KA 003 389-081 Licence Plate Light	44
				T4W; Lateral Mounting; Red/Black; Number of light functions: 1; with lamp base	2XS 005 020-041 Marker Lamp	45

Manufacturer - Model	Power	Displ.	Year of Constr.	Remark	Part Number	Page
MAN - Cab-over Trucks						07/86→05/94
19.362 U,19.362 UL, 19.362 ULL	265 kW		07/86→01/91	R10W; without lamp base; with screw	9BG 121 587-031	27
24.322 UNL,24.322 UNLL	235 kW		02/90→12/90		Housing, licence plate light	
24.372 UNL,24.372 UNLL	272 kW		02/90→12/90			
24.422 UNL,24.422 UNLL	309 kW		02/90→12/90			
				Additionally required articles (article numbers): 9EL 122 689-021 / 9EL 122 689-051; P21W / R10W; Left	9BG 130 945-001	26
				Additionally required articles (article numbers): 9EL 122 689-021 / 9EL 122 689-051; P21W / R10W; Right	9BG 130 946-001	26
				P21W / R10W; Left / Right; with reverse light / with reflector / with tail light / with indicator / with stop light / with fog taillight; Number of light functions: 6; without lamp base	9EL 122 689-021 Lens,	31
				P21W / R10W; Left / Right; with reverse light / with reflector / with tail light / with indicator / with stop light; Number of light functions: 5; without lamp base	9EL 122 689-051 Lens,	32
				T4W; Lateral Mounting; Red; without lamp base; with screws	9EL 132 215-011 Lens,	33
				H4; Left / Right; for right-hand traffic	9ES 120 743-001	4
					Diffusing Lens, headlight	
25.322 UNL,25.322 UNLL	235 kW		09/90→12/92	T4W / H4; Left / Right; Number of light functions: 3; 12 V / 24 V	1AG 003 434-211	10
25.372 UNL,25.372 UNLL	272 kW		09/90→12/92		Headlight	
25.422 UNL,25.422 UNLL	309 kW		09/90→12/92	H3; Depth [mm]: 76; Left / Right; Short distance lighting; 12 V / 24 V	1G4 004 480-001	25
				10/90→; H3; Fitting Depth [mm]: 89; Left / Right; Transparent; Number of light functions: 1; + H 166 mm; 12 V / 24 V	1NE 006 300-051 Fog Light	7
				P21W; Left / Right; Yellow; Number of light functions: 1; with lamp base	2BA 007 840-001	47
				→12/91; P21W; Left / Right; Number of light functions: 1; with lamp base	2KA 003 389-081	44
				T4W; Lateral Mounting; Red/Black; Number of light functions: 1; with lamp base	2XS 005 020-041	45
				→12/91; R10W; without lamp base; with screw	9BG 121 587-031	27
					Housing, licence plate light	
				→12/91; Additionally required articles (article numbers): 9EL 122 689-021 / 9EL 122 689-051; P21W / R10W; Left	9BG 130 945-001	26
				→12/91; Additionally required articles (article numbers): 9EL 122 689-021 / 9EL 122 689-051; P21W / R10W; Right	9BG 130 946-001	26
				→12/91; P21W / R10W; Left / Right; with reverse light / with reflector / with tail light / with indicator / with stop light / with fog taillight; Number of light functions: 6; without lamp base	9EL 122 689-021 Lens,	31
				→12/91; P21W / R10W; Left / Right; with reverse light / with reflector / with tail light / with indicator / with stop light; Number of light functions: 5; without lamp base	9EL 122 689-051 Lens,	32
				T4W; Lateral Mounting; Red; without lamp base; with screws	9EL 132 215-011 Lens,	33
				H4; Left / Right; for right-hand traffic	9ES 120 743-001	4
					Diffusing Lens, headlight	
MAN - E 2000						05/00→
19.310 FALK	228 kW		05/00→	T4W / H4; Left / Right; Number of light functions: 3; without bulbs; for vehicles without headlamp levelling	1EF 354 340-011	15
19.310 FALS	228 kW		05/00→		Headlight	
19.310 FLK	228 kW		05/00→			
19.310 FLS	228 kW		05/00→	T4W / H4; Left / Right; Number of light functions: 3; without bulbs / with motor for headlamp levelling; for vehicles with headlamp levelling (electric)	1EF 354 340-021	16
19.360 FALK	265 kW		05/00→		Headlight	
19.360 FALS	265 kW		05/00→			
19.360 FLK	265 kW		05/00→			
19.360 FLS	265 kW		05/00→			
19.410 FALK	301 kW		05/00→			
19.410 FALS	301 kW		05/00→			
19.410 FLK	301 kW		05/00→			
19.410 FLS	301 kW		05/00→			
19.460 FALK	338 kW		05/00→			
19.460 FALS	338 kW		05/00→			
19.460 FLK	338 kW		05/00→			
19.460 FLS	338 kW		05/00→			
26.310 FAVLC	228 kW		05/00→			
26.310 FAVLK	228 kW		05/00→			
26.360 FAVLC	265 kW		05/00→			
26.360 FAVLK	265 kW		05/00→			
26.410 DFARC	301 kW		05/00→			
26.410 DFRC, FAVLC	301 kW		05/00→			

Manufacturer - Model	Power	Displ.	Year of Constr.	Remark	Part Number	Page
MAN - E 2000						05/00→
26.410 FAVLK	301 kW		05/00→	T4W / H4; Left / Right; Number of light functions: 3; without bulbs; for vehicles without headlamp levelling	1EF 354 340-011 Headlight	15
26.460 DFARC	338 kW		05/00→			
26.460 DFLRS	338 kW		05/00→	T4W / H4; Left / Right; Number of light functions: 3; without bulbs / with motor for headlamp levelling; for vehicles with headlamp levelling (electric)	1EF 354 340-021 Headlight	16
26.460 FAVLC	338 kW		05/00→			
26.460 FAVLK	338 kW		05/00→			
28.230 FNLC	170 kW		05/00→			
28.310 FNLC	228 kW		05/00→			
28.360 FANLC	265 kW		05/00→			
28.360 FANLK	265 kW		05/00→			
28.360 FNALC	265 kW		05/00→			
28.360 FNLC	265 kW		05/00→			
28.410 FANLC	301 kW		05/00→			
28.410 FANLK	301 kW		05/00→			
28.410 FNLC	301 kW		05/00→			
28.460 FANLC	338 kW		05/00→			
28.460 FANLK	338 kW		05/00→			
28.460 FNLC	338 kW		05/00→			
29.460 FVAS	338 kW		05/00→			
30.310 FNLC	228 kW		05/00→			
30.360 FANLC	265 kW		05/00→			
30.360 FANLK	265 kW		05/00→			
30.360 FNLC	265 kW		05/00→			
30.410 FANLC	301 kW		05/00→			
30.410 FANLK	301 kW		05/00→			
30.410 FNLC	301 kW		05/00→			
30.460 FANLC	338 kW		05/00→			
30.460 FANLK	338 kW		05/00→			
30.460 FNLC	338 kW		05/00→			
32.310 VFCL	228 kW		05/00→			
32.310 VFNLC	228 kW		05/00→			
32.360 VFCL	265 kW		05/00→			
32.360 VFNLC	265 kW		05/00→			
32.410 VFARK	301 kW		05/00→			
32.410 VFCL, VFRC, VFRLC	301 kW		05/00→			
32.410 VFNLC	301 kW		05/00→			
32.460 VFCL, VFRLC	338 kW		05/00→			
32.460 VFNLC	338 kW		05/00→			
33.360 DFAK, DFALK	265 kW		05/00→			
33.360 DFALC	265 kW		05/00→			
33.360 DFALS	265 kW		04/01→			
33.360 DFCL	265 kW		05/00→			
33.360 DFLK	265 kW		05/00→			
33.360 DFSL	265 kW		05/00→			
33.410 DFAK, DFALK	301 kW		05/00→			
33.410 DFALC	301 kW		05/00→			
33.410 DFALS	301 kW		04/01→			
33.410 DFCL	301 kW		05/00→			
33.410 DFLK	301 kW		05/00→			
33.410 DFSL	301 kW		05/00→			
33.460 DFAK, DFALK	338 kW		05/00→			
33.460 DFALC	338 kW		05/00→			
33.460 DFALS	338 kW		04/01→			
33.460 DFCL	338 kW		05/00→			
33.460 DFLK	338 kW		05/00→			
33.460 DFSL	338 kW		05/00→			
33.600 DFALS, DFAS	441 kW		06/00→			
33.600 DFSL	441 kW		06/00→			
35.360 VFAK	265 kW		05/00→			
35.410 FVNLC	301 kW		05/00→			
35.410 VFAK	301 kW		05/00→			
35.460 FVNLC	338 kW		05/00→			
35.460 VFAK	338 kW		05/00→			
40.600 DFAS	441 kW		06/00→			
41.360 VFAK	265 kW		05/00→			
41.410 VFAK	301 kW		05/00→			
41.460 DFVS, DFVLS	338 kW		06/00→			
41.460 VFAK	338 kW		05/00→			
41.600 DFVS, DFVLS	441 kW		06/00→			
50.410 VFAK	301 kW		05/00→			
50.410 VFAVK, VFAV-G	301 kW		03/01→			
50.410 VFK	301 kW		05/00→			
50.410 VFVK, VFV-G	301 kW		10/00→			
50.460 VFAK	338 kW		05/00→			
50.460 VFAVK, VFAV-G	338 kW		03/01→			
50.460 VFK	338 kW		05/00→			
50.460 VFVK, VFV-G	338 kW		10/00→			
50.600 VFAS	441 kW		05/00→			

Manufacturer - Model	Power	Displ.	Year of Constr.	Remark	Part Number	Page
MAN - EL					01/93→06/97	
EL 202,EL 222 EL 202,EL 262	157 - 169 kW 184 kW		01/93→06/97 04/94→06/97	T4W / H4; Depth [mm]: 198; Left / Right; Manufacturer Restriction: Ref. 25/37,5; Number of light functions: 3; without indicator lamp; for vehicles with headlamp levelling	1AG 003 434-251 Headlight	11
				P21W; Left / Right; Number of light functions: 1; with lamp base	2KA 003 389-081 Licence Plate Light	44
				P21W / R10W; Left; Number of light functions: 3; 12 V / 24 V; with lamp base	2SD 003 167-531 Combination Rearlight	34
				P21W / R10W; Right; Number of light functions: 3; 12 V / 24 V; with lamp base	2SD 003 167-541 Combination Rearlight	35
				R10W; without lamp base; with screw	9BG 121 587-031 Housing, licence plate light	27
				P21W / R10W; Left / Right; Number of light functions: 4; without lamp base; with screws	9EL 147 747-001 Lens, combination rearlight	32
				H4; Left / Right; for right-hand traffic	9ES 120 743-001 Diffusing Lens, headlight	4
MAN - EM					08/87→	
EM 192 EM 222,EM 223 EM 223	140 kW 162 kW 162 kW		10/93→06/97 02/96→ 08/87→	T4W / H4; Left / Right; Number of light functions: 3; 12 V / 24 V	1AG 003 434-211 Headlight	10
MAN - F 9					01/83→12/86	
15.192 F, 15.192 FL 15.192 FS	141 kW 141 kW		01/83→12/86 01/83→12/86	T4W / H4; Depth [mm]: 198; Left / Right; Manufacturer Restriction: Ref. 25/37,5; Number of light functions: 3; without indicator lamp; for vehicles with headlamp levelling	1AG 003 434-251 Headlight	11
				P21W; Left / Right; Number of light functions: 1; with lamp base	2KA 003 389-081 Licence Plate Light	44
				→12/83; P21W / R10W; Left; Number of light functions: 6	2VP 003 567-111 Combination Rearlight	39
				→12/83; P21W / R10W; Right; Number of light functions: 6	2VP 003 567-121 Combination Rearlight	40
				R10W; without lamp base; with screw	9BG 121 587-031 Housing, licence plate light	27
				01/84→; Additionally required articles (article numbers): 9EL 122 689-021 / 9EL 122 689-051; P21W / R10W; Left	9BG 130 945-001 Housing, combination rearlight	26
				01/84→; Additionally required articles (article numbers): 9EL 122 689-021 / 9EL 122 689-051; P21W / R10W; Right	9BG 130 946-001 Housing, combination rearlight	26
				P21W / R10W; Left / Right; with reverse light / with reflector / with tail light / with indicator / with stop light / with fog taillight; Number of light functions: 6; without lamp base	9EL 122 689-021 Lens, combination rearlight	31
				01/84→; P21W / R10W; Left / Right; with reverse light / with reflector / with tail light / with indicator / with stop light; Number of light functions: 5; without lamp base	9EL 122 689-051 Lens, combination rearlight	32
				H4; Left / Right; for right-hand traffic	9ES 120 743-001 Diffusing Lens, headlight	4
MAN - F 90					07/86→	
15.192 FL 19.242 F,19.242 FL,19.242 FLL 19.242 FK 19.242 FS,19.242 FLS,19.242 FLLS	141 kW 177 kW 177 kW 177 kW			T4W / H4; Left / Right; Number of light functions: 3; 12 V / 24 V	1AG 003 434-211 Headlight	10
			01/88→01/89	H3; Depth [mm]: 76; Left / Right; Short distance lighting; 12 V / 24 V	1G4 004 480-001 Worklight	25
			01/88→01/89	P21W; Left / Right; Yellow; Number of light functions: 1; with lamp base	2BA 007 840-001 Indicator	47
19.262 F,19.262 FL,19.262 FLL 19.262 FA 19.262 FAK 19.262 FAS 19.262 FK	191 kW 191 kW 191 kW 191 kW 191 kW		01/88→02/90 02/89→02/90 02/89→02/90 02/89→02/90 01/88→02/90	P21W; Left / Right; Number of light functions: 1; with lamp base	2KA 003 389-081 Licence Plate Light	44
19.262 FS,19.262 FLS,19.262 FLLS	191 kW		01/88→02/90	T4W; Lateral Mounting; Red/Black; Number of light functions: 1; with lamp base	2XS 005 020-041 Marker Lamp	45
19.292 F,19.292 FL,19.292 FLL 19.292 FA 19.292 FAK 19.292 FAS 19.292 FK	213 kW 213 kW 213 kW 213 kW 213 kW		07/86→02/90 05/88→02/90 05/88→02/90 05/88→02/90 07/86→02/90	R10W; without lamp base; with screw	9BG 121 587-031 Housing, licence plate light	27
19.292 FS,19.292 FLS,19.292 FLLS	213 kW		07/86→02/90	Additionally required articles (article numbers): 9EL 122 689-021 / 9EL 122 689-051; P21W / R10W; Left	9BG 130 945-001 Housing, combination rearlight	26
19.332 F,19.332 FL,19.332 FLL 19.332 FA 19.332 FAK 19.332 FAS 19.332 FK	243 kW 243 kW 243 kW 243 kW 243 kW		07/86→02/90 05/88→02/90 05/88→02/90 05/88→02/90 07/86→02/90	Additionally required articles (article numbers): 9EL 122 689-021 / 9EL 122 689-051; P21W / R10W; Right	9BG 130 946-001 Housing, combination rearlight	26
				P21W / R10W; Left / Right; with reverse light / with reflector / with tail light / with indicator / with stop light / with fog taillight; Number of light functions: 6; without lamp base	9EL 122 689-021 Lens, combination rearlight	31

Manufacturer - Model	Power	Displ.	Year of Constr.	Remark	Part Number	Page
MAN - F 90						07/86→
19.332 FS,19.332 FLS,19.332 FLLS	243 kW		07/86→02/90	P21W / R10W; Left / Right; with reverse light / with reflector / with tail light / with indicator / with stop light; Number of light functions: 5; without lamp base	9EL 122 689-051 Lens, combination rearlight	32
19.362 F, 19.362 FL, 19.362 FLL	265 kW		07/86→02/90			
19.362 FA	265 kW		05/88→02/90			
19.362 FAK	265 kW		05/88→02/90	T4W; Lateral Mounting; Red; without lamp base; with screws	9EL 132 215-011 Lens, marker lamp	33
19.362 FAS	265 kW		05/88→02/90			
19.362 FK	265 kW		07/86→02/90			
19.362 FS, 19.362 FLS, 19.362 FLLS	265 kW		07/86→02/90	H4; Left / Right; for right-hand traffic	9ES 120 743-001 Diffusing Lens, headlight	4
19.462 F, 19.462 FL	338 kW		05/87→02/90			
19.462 FK	338 kW		05/87→02/90			
19.462 FS, 19.462 FLS	338 kW		05/87→02/90			
24.242 DF	177 kW		01/88→07/89			
24.242 DFK	177 kW		01/88→07/89			
24.242 DFS	177 kW		01/88→07/89			
24.242 FNL, 24.242 FNLL, 24.242 FVL	177 kW		01/88→02/90			
24.262 DF	191 kW		01/88→02/90			
24.262 DFK	191 kW		01/88→02/90			
24.262 DFS, 24.262 DFSL	191 kW		01/88→02/90			
24.262 FNL, 24.262 FNLL, 24.262 FVL	191 kW		01/88→02/90			
24.272 DF	198 kW		02/90→12/90			
24.292 DF	213 kW		04/87→02/90			
24.292 DFK	213 kW		04/87→02/90			
24.292 DFS, 24.292 DFSL	213 kW		04/87→02/90			
24.292 FNL, 24.292 FNLL, 24.292 FVL	213 kW		10/86→02/90			
24.292 FNLS, 24.292 FVLS	213 kW		10/86→02/90			
24.302 DF	220 kW		05/90→12/90			
24.302 FNL, 24.302 FNLL, 24.302 FVL	220 kW		05/90→10/90			
24.322 DF	235 kW		02/90→12/90			
24.332 DF	243 kW		04/87→02/90			
24.332 DFK	243 kW		04/87→02/90			
24.332 DFS, 24.332 DFSL	243 kW		04/87→02/90			
24.332 FNL, 24.332 FNLL, 24.332 FVL	243 kW		10/86→02/90			
24.332 FNLS, 24.332 FVLS	243 kW		10/86→02/90			
24.362 DF	265 kW		04/87→02/90			
24.362 DFK	265 kW		04/87→02/90			
24.362 DFS, 24.362 DFSL	265 kW		04/87→02/90			
24.362 FNL, 24.362 FNLL, 24.362 FVL	265 kW		10/86→02/90			
24.362 FNLS, 24.362 FVLS	265 kW		10/86→02/90			
24.462 DF	338 kW		02/89→02/90			
24.462 DFS	338 kW		02/89→02/90			
24.462 FNL	338 kW		04/89→02/90			
24.462 FVLS	338 kW		05/87→07/87			
26.242 DF	177 kW		01/88→07/89			
26.242 DFAK	177 kW		02/89→07/89			
26.242 DFK	177 kW		01/88→07/89			
26.242 DFS	177 kW		01/88→07/89			
26.262 DF	191 kW		01/88→02/90			
26.262 DFA	191 kW		02/89→02/90			
26.262 DFAK	191 kW		02/89→02/90			
26.262 DFAS	191 kW		02/89→02/90			
26.262 DFK	191 kW		01/88→02/90			
26.262 DFS	191 kW		01/88→02/90			
26.292 DF, 26.292 DFL	213 kW		09/87→02/90			
26.292 DFA	213 kW		05/88→02/90			
26.292 DFAK	213 kW		05/88→02/90			
26.292 DFAS	213 kW		05/88→02/90			
26.292 DFK	213 kW		09/87→02/90			
26.292 DFS	213 kW		09/87→02/90			
26.332 DF, 26.332 DFL	243 kW		09/87→02/90			
26.332 DFA	243 kW		05/88→02/90			
26.332 DFAK	243 kW		05/88→02/90			
26.332 DFAS	243 kW		05/88→02/90			
26.332 DFK	243 kW		09/87→02/90			
26.332 DFS	243 kW		09/87→02/90			
26.362 DF, 26.362 DFL	265 kW		09/87→02/90			
26.362 DFA	265 kW		05/88→02/90			
26.362 DFAK	265 kW		05/88→02/90			
26.362 DFAS	265 kW		05/88→02/90			
26.362 DFK	265 kW		09/87→02/90			
26.362 DFS	265 kW		09/87→02/90			
26.462 DF	338 kW		02/89→02/90			
26.462 DFA	338 kW		08/89→02/90			
26.462 DFAS	338 kW		08/89→02/90			
26.462 DFS	338 kW		02/89→02/90			

Manufacturer - Model	Power	Displ.	Year of Constr.	Remark	Part Number	Page
MAN - F 90						07/86→
32.262 VF	191 kW		02/89→02/90			
32.262 VFK	191 kW		02/89→02/90			
32.262 VFTM	191 kW		02/89→02/90			
32.292 VF	213 kW		03/88→02/90			
32.292 VFK	213 kW		03/88→02/90			
32.302 VFK	220 kW		05/90→09/91			
32.332 VF	243 kW		03/88→02/90			
32.332 VFK	243 kW		03/88→02/90			
32.362 VF	265 kW		03/88→02/90			
32.362 VFK	265 kW		03/88→02/90			
33.242 DFAK	177 kW		01/88→08/88			
33.242 DFK	177 kW		01/88→08/88			
33.262 DF	191 kW		08/88→02/90			
33.262 DFA	191 kW		07/89→02/90			
33.262 DFAK	191 kW		07/89→02/90			
33.262 DFK	191 kW		08/88→02/90			
33.292 DF	213 kW		09/87→02/90			
33.292 DFA	213 kW		05/88→02/90			
33.292 DFAK	213 kW		05/88→02/90			
33.292 DFAS	213 kW		05/88→02/90			
33.292 DFK	213 kW		09/87→02/90			
33.292 DFS	213 kW		09/87→02/90			
33.332 DF	243 kW		09/87→02/90			
33.332 DFA	243 kW		05/88→02/90			
33.332 DFAK	243 kW		05/88→02/90			
33.332 DFAS	243 kW		05/88→02/90			
33.332 DFK	243 kW		09/87→02/90			
33.332 DFS	243 kW		09/87→02/90			
33.362 DF	265 kW		09/87→02/90			
33.362 DFA	265 kW		05/88→02/90			
33.362 DFAK	265 kW		05/88→02/90			
33.362 DFAS	265 kW		05/88→02/90			
33.362 DFK	265 kW		09/87→02/90			
33.362 DFS	265 kW		09/87→02/90			
33.462 DF	338 kW		07/89→02/90			
33.462 DFA	338 kW		07/89→02/90			
35.262 VF	191 kW		02/89→02/90			
35.262 VFA	191 kW		07/89→02/90			
35.262 VFK	191 kW		02/89→02/90			
35.362 VF	265 kW		10/88→02/90			
35.362 VFK	265 kW		10/88→02/90			
40.462 DF	338 kW		07/89→02/90			
40.462 DFA	338 kW		07/89→02/90			
41.262 VF	191 kW		07/89→02/90			
41.262 VFK	191 kW		07/89→02/90			
41.292 VF	213 kW		10/88→02/90			
41.292 VFK	213 kW		10/88→02/90			
41.332 VF	243 kW		10/88→02/90			
41.332 VFK	243 kW		10/88→02/90			
41.362 VF	265 kW		10/88→02/90			
41.362 VFK	265 kW		10/88→02/90			
48.292 VF	213 kW		07/89→02/90			
48.292 VFA	213 kW		07/89→02/90			
48.292 VFAK	213 kW		07/89→02/90			
48.332 VF	243 kW		07/89→02/90			
48.332 VFA	243 kW		07/89→02/90			
48.332 VFAK	243 kW		07/89→02/90			
48.362 VF	265 kW		07/89→02/90			
48.362 VFA	265 kW		07/89→02/90			
48.362 VFAK	265 kW		07/89→02/90			
48.462 VF	338 kW		07/89→02/90			
19.272 F, 19.272 FL, 19.272 FLL	198 kW		02/90→05/95	T4W / H4; Left / Right; Number of light functions: 3; 12 V / 24 V	1AG 003 434-211	10
19.272 FA	198 kW		02/90→05/95		Headlight	
19.272 FAK	198 kW		02/90→05/95	H3; Depth [mm]: 76; Left / Right; Short distance lighting; 12 V / 24 V	1G4 004 480-001	25
19.272 FAS	198 kW		02/90→05/95		Worklight	
19.272 FK	198 kW		02/90→05/95	10/90→; →04/93; H3; Fitting Depth [mm]: 89; Left / Right; Transparent; Number of light functions: 1; + H 166 mm; 12 V / 24 V	1NE 006 300-051	7
19.272 FS, 19.272 FLS, 19.272 FLLS	198 kW		02/90→05/95		Fog Light	
19.322 F, 19.322 FL, 19.322 FLL	235 kW		02/90→05/95	P21W; Left / Right; Yellow; Number of light functions: 1; with lamp base	2BA 007 840-001	47
19.322 FA	235 kW		02/90→06/96		Indicator	
19.322 FAK	235 kW		02/90→06/96	→12/91; P21W; Left / Right; Number of light functions: 1; with lamp base	2KA 003 389-081	44
19.322 FAS	235 kW		02/90→06/96		Licence Plate Light	
19.322 FK	235 kW		02/90→05/95	T4W; Lateral Mounting; Red/Black; Number of light functions: 1; with lamp base	2XS 005 020-041	45
19.322 FS, 19.322 FLS, 19.322 FLLS	235 kW		02/90→05/95		Marker Lamp	
19.372 F, 19.372 FL, 19.372 FLL	249 kW		05/90→04/95	→12/91; R10W; without lamp base; with screw	9BG 121 587-031	27
19.372 F, 19.372 FL, 19.372 FLL	272 kW		02/90→05/95		Housing, licence plate light	
19.372 FA	272 kW		02/90→06/96		light	
19.372 FAK	272 kW		02/90→06/96	→12/91; Additionally required articles (article numbers): 9EL 122 689-021 / 9EL 122 689-051; P21W / R10W; Left	9BG 130 945-001	26
19.372 FAS	272 kW		02/90→06/96		Housing, combination rearlight	
19.372 FK	249 kW		05/90→04/95			

Manufacturer - Model	Power	Displ.	Year of Constr.	Remark	Part Number	Page
MAN - F 90						07/86→
19.372 FK	272 kW		02/90→05/95	→12/91; Additionally required articles (article numbers): 9EL 122 689-021 / 9EL 122 689-051; P21W / R10W; Right	9BG 130 946-001 Housing, combination rearlight	26
19.372 FS,19.372 FLS,19.372 FLLS	249 kW		05/90→04/95			
19.372 FS,19.372 FLS,19.372 FLLS	272 kW		02/90→05/95	→12/91; P21W / R10W; Left / Right; with reverse light / with reflector / with tail light / with indicator / with stop light / with fog taillight; Number of light functions: 6; without lamp base	9EL 122 689-021 Lens, combination rearlight	31
19.422 F,19.422 FL,19.422 FLL	309 kW		02/90→05/95			
19.422 FA	309 kW		02/90→06/96	→12/91; P21W / R10W; Left / Right; with reverse light / with reflector / with tail light / with indicator / with stop light; Number of light functions: 5; without lamp base	9EL 122 689-051 Lens, combination rearlight	32
19.422 FAK	309 kW		02/90→06/96			
19.422 FAS	309 kW		02/90→06/96	T4W; Lateral Mounting; Red; without lamp base; with screws	9EL 132 215-011 Lens, marker lamp	33
19.422 FK	309 kW		02/90→05/95			
19.422 FS,19.422 FLS,19.422 FLLS	309 kW		02/90→05/95	H4; Left / Right; for right-hand traffic	9ES 120 743-001 Diffusing Lens, headlight	4
19.502 F,19.502 FL,19.502 FLL	368 kW		02/90→06/96			
19.502 FS,19.502 FLS,19.502 FLLS	368 kW		02/90→06/96			
24.272 DFS,24.272 DFLS	198 kW		02/90→04/95			
24.272 FNL,24.272 FNLL,24.272 FVL	198 kW		02/90→05/95			
24.272 FNLS,24.272 FVLS	198 kW		02/90→05/95			
24.302 DFS,24.302 DFLS	220 kW		05/90→04/95			
24.322 FNL,24.322 FNLL,24.322 FVL	235 kW		02/90→05/95			
24.322 FNLS,24.322 FVLS	235 kW		02/90→05/95			
24.372 DFS, 24.372 DFLS	272 kW		02/90→04/95			
24.372 FNL,24.372 FNLL,24.372 FVL	272 kW		02/90→05/95			
24.372 FNLS,24.372 FVLS	272 kW		02/90→05/95			
24.422 FNL,24.422 FNLL,24.422 FVL	309 kW		02/90→05/95			
25.272 FNL,25.272 FNLL,25.272 FVL	198 kW		09/90→10/93			
25.372 FNLS,25.372 FVLS	272 kW		09/90→10/93			
25.372 FVLS	249 kW		09/90→10/93			
26.272 DF	198 kW		02/90→06/96			
26.272 DFK	198 kW		02/90→06/96			
26.272 DFS,26.272 DFLS	198 kW		02/90→06/96			
26.272 FNLS,26.272 FVLS	198 kW		09/90→12/95			
26.322 DF	235 kW		02/90→06/96			
26.322 DFS,26.322 DFLS	235 kW		02/90→06/96			
26.322 FNLS,26.322 FVLS	235 kW		09/90→12/95			
26.372 DF,26.372 DFL	272 kW		02/90→06/96			
26.372 DFS	272 kW		02/90→06/96			
26.372 FNL,26.372 FNLL,26.372 FVL	272 kW		09/90→12/95			
26.422 DF,26.422 DFL	309 kW		02/90→06/96			
26.422 DFK	309 kW		02/90→12/95			
26.422 DFS	309 kW		02/90→12/95			
26.422 FNL,26.422 FNLL,26.422 FVL	309 kW		09/90→12/95			
26.502 DF	368 kW		02/90→06/96			
26.502 DFS,26.502 DFLS	368 kW		02/90→06/96			
32.272 VF	198 kW		02/90→04/95			
32.272 VFK	198 kW		02/90→04/95			
32.322 VF	235 kW		02/90→06/96			
32.322 VFK	235 kW		02/90→06/96			
32.372 VF	249 kW		02/90→06/96			
32.372 VFK	272 kW		02/90→06/96			
32.372 VFK	249 kW		05/90→04/95			
32.372 VFK	272 kW		02/90→06/96			
32.422 VF	309 kW		02/90→06/96			
32.422 VFK	309 kW		02/90→06/96			
35.292 VF	213 kW		10/88→04/95			
35.292 VFK	213 kW		10/88→04/95			
35.322 VFAK	235 kW		02/90→06/96			
35.322 VFK	235 kW		02/90→06/96			
35.322 VK	235 kW		02/90→06/96			
35.332 VF	243 kW		10/88→04/95			
35.332 VFK	243 kW		10/88→04/95			
35.372 VF	272 kW		02/90→06/96			
35.372 VFK	272 kW		02/90→12/97			
35.372 VFK	249 kW		02/90→04/95			
35.372 VFK	272 kW		02/90→06/96			
35.372 VFK	272 kW		02/90→12/97			
35.422 VF	309 kW		02/90→06/96			
35.422 VF	309 kW		02/90→12/97			
35.422 VFK	309 kW		02/90→06/96			
35.422 VFK	309 kW		02/90→12/97			
40.502 DFA	368 kW		02/90→06/96			
41.322 VF	235 kW		02/90→06/96			
41.372 VF	272 kW		02/90→06/96			
41.422 VF	309 kW		02/90→06/96			

Manufacturer - Model	Power	Displ.	Year of Constr.	Remark	Part Number	Page
MAN - F 90						07/86→
19.342 F,19.342 FL,19.342 FLL	250 kW		05/94→05/95	T4W / H4; Left / Right; Number of light functions: 3; 12 V / 24 V	1AG 003 434-211 Headlight	10
19.342 FA	250 kW		05/94→06/96			
19.342 FAK	250 kW		05/94→06/96	H3; Depth [mm]: 76; Left / Right; Short distance lighting; 12 V / 24 V	1G4 004 480-001 Worklight	25
19.342 FAS	250 kW		05/94→06/96			
19.342 FK	250 kW		05/94→05/95	P21W; Left / Right; Yellow; Number of light functions: 1; with lamp base	2BA 007 840-001 Indicator	47
19.342 FS,19.342 FLS,19.342 FLLS	250 kW		05/94→05/95			
19.402 F,19.402 FL,19.402 FLL	294 kW		05/94→05/95	T4W; Lateral Mounting; Red/Black; Number of light functions: 1; with lamp base	2XS 005 020-041 Marker Lamp	45
19.402 FA	294 kW		05/94→06/96			
19.402 FAK	294 kW		05/94→06/96	T4W; Lateral Mounting; Red; without lamp base; with screws	9EL 132 215-011 Lens, marker lamp	33
19.402 FAS	294 kW		05/94→06/96			
19.402 FK	294 kW		05/94→05/95	H4; Left / Right; for right-hand traffic	9ES 120 743-001 Diffusing Lens, headlight	4
19.402 FS,19.402 FLS,19.402 FLLS	294 kW		05/94→05/95			
24.342 FNL,24.342 FNLL	250 kW		05/94→05/95			
24.402 FNL,24.402 FNLL	294 kW		05/94→05/95			
26.342 DF,26.342 DFL	250 kW		05/94→06/96			
26.342 DFK,26.342 DFLK	250 kW		05/94→06/96			
26.342 DFS	250 kW		04/94→06/96			
26.372 DFAK	272 kW		01/92→06/96			
26.402 DF,26.402 DFL	294 kW		05/94→06/96			
26.402 DFK,26.402 DFLK	294 kW		05/94→06/96			
26.402 DFS	294 kW		05/94→12/95			
26.402 FNL,26.402 FNLL,26.402 FVL	294 kW		05/94→06/96			
26.402 FNLS,26.402 FVLS	294 kW		05/94→06/96			
26.422 FNLS,26.422 FVLS	309 kW		01/92→12/95			
26.502 FNL,26.502 FNLL	368 kW		09/91→06/96			
32.342 VFK	250 kW		05/94→06/96			
32.402 VFK	294 kW		05/94→06/96			
33.272 DF	198 kW		10/92→04/95			
33.272 DFA	198 kW		10/92→04/95			
33.322 DF	235 kW		09/91→06/96			
33.322 DFA	235 kW		09/91→06/96			
33.342 DF	250 kW		05/94→06/96			
33.342 DFA	250 kW		05/94→06/96			
33.372 DF	272 kW		09/91→06/96			
33.372 DFA	272 kW		09/91→06/96			
33.372 DFS	272 kW		09/91→06/96			
33.402 DF	294 kW		05/94→06/96			
33.402 DFA	294 kW		05/94→06/96			
33.402 DFAK	294 kW		05/94→06/96			
33.402 DFK	294 kW		05/94→06/96			
33.402 DFS	294 kW		05/94→06/96			
33.422 DF	309 kW		09/91→06/96			
33.422 DFA	309 kW		09/91→06/96			
33.422 DFAK	309 kW		01/94→06/96			
33.422 DFK	309 kW		01/94→06/96			
33.422 DFS	309 kW		01/94→06/96			
33.502 DF	368 kW		09/91→06/96			
33.502 DFA	368 kW		09/91→06/96			
35.342 VF	250 kW		05/94→06/96			
35.342 VFK	250 kW		05/94→06/96			
35.402 VF	294 kW		05/94→06/96			
35.402 VFK	294 kW		05/94→12/97			
35.402 VFK	294 kW		05/94→06/96			
35.402 VFK	294 kW		05/94→12/97			
40.402 DF	294 kW		05/95→06/96			
40.402 DFA	294 kW		05/95→06/96			
41.342 VF	250 kW		05/94→06/96			
41.402 VF	294 kW		05/94→06/96			
24.272 DFK	198 kW		02/90→12/90	T4W / H4; Left / Right; Number of light functions: 3; 12 V / 24 V	1AG 003 434-211 Headlight	10
24.302 DFK	220 kW		05/90→12/90			
24.322 DFK	235 kW		02/90→12/90	H3; Depth [mm]: 76; Left / Right; Short distance lighting; 12 V / 24 V	1G4 004 480-001 Worklight	25
24.322 DFS,24.322 DFSL	235 kW		02/90→12/90			
24.372 DF	249 kW		05/90→12/90	10/90→ ; H3; Fitting Depth [mm]: 89; Left / Right; Transparent; Number of light functions: 1; + H 166 mm; 12 V / 24 V	1NE 006 300-051 Fog Light	7
24.372 DF	272 kW		02/90→12/90			
24.372 DFK	249 kW		05/90→12/90			
24.372 DFK	272 kW		02/90→12/90	P21W; Left / Right; Yellow; Number of light functions: 1; with lamp base	2BA 007 840-001 Indicator	47
24.372 DFS	249 kW		05/90→12/90			
24.372 FVL	249 kW		05/90→12/90	P21W; Left / Right; Number of light functions: 1; with lamp base	2KA 003 389-081 Licence Plate Light	44
24.372 FVLS	249 kW		05/90→12/90			
24.422 DF	309 kW		02/90→12/90			
24.422 DFK	309 kW		02/90→12/90	T4W; Lateral Mounting; Red/Black; Number of light functions: 1; with lamp base	2XS 005 020-041 Marker Lamp	45
24.422 DFS,24.422 DFSL	309 kW		02/90→12/90			
24.502 DF	368 kW		02/90→12/90	R10W; without lamp base; with screw	9BG 121 587-031 Housing, licence plate light	27
24.502 DFK	368 kW		02/90→12/90			
24.502 DFS	368 kW		02/90→12/90			
24.502 FNL	368 kW		02/90→12/90			
25.302 DF	220 kW		09/90→12/91	Additionally required articles (article numbers): 9EL 122 689-021 / 9EL 122 689-051; P21W / R10W; Left	9BG 130 945-001 Housing, combination rearlight	26
25.302 DFK	220 kW		09/90→12/91			

Manufacturer - Model	Power	Displ.	Year of Constr.	Remark	Part Number	Page
MAN - F 90						07/86→
25.302 DFS, 25.302 DFLS	220 kW		09/90→12/91	Additionally required articles (article numbers): 9EL 122 689-021 / 9EL 122 689-051; P21W / R10W; Right	9BG 130 946-001 Housing, combination rearlight	26
25.302 FNL, 25.302 FNLL, 25.302 FVL	220 kW		09/90→12/91			
25.302 FNLS, 25.302 FVLS	220 kW		09/90→12/91	P21W / R10W; Left / Right; with reverse light / with reflector / with tail light / with indicator / with stop light / with fog taillight; Number of light functions: 6; without lamp base	9EL 122 689-021 Lens,	31
26.302 DF	220 kW		05/90→12/91			
26.302 DFA	220 kW		05/90→12/91			
26.302 DFAK	220 kW		05/90→12/91			
26.302 DFAS	220 kW		05/90→12/91	P21W / R10W; Left / Right; with reverse light / with reflector / with tail light / with indicator / with stop light; Number of light functions: 5; without lamp base	9EL 122 689-051 Lens,	32
26.302 DFK	220 kW		05/90→12/91			
26.302 DFS	220 kW		05/90→12/91			
26.302 FNLS, 26.302 FVLS	220 kW		09/90→12/91			
32.302 VF	220 kW		05/90→09/91	T4W; Lateral Mounting; Red; without lamp base; with screws	9EL 132 215-011 Lens,	33
35.272 VF	198 kW		02/90→12/91			
35.302 VF	220 kW		05/90→09/91	H4; Left / Right; for right-hand traffic	9ES 120 743-001	4
35.302 VFA	220 kW		05/90→09/91		Diffusing Lens, headlight	
35.302 VFAK	220 kW		05/90→09/91			
35.302 VFK	220 kW		05/90→09/91			
41.272 VF	198 kW		02/90→12/91			
25.272 DF	198 kW		09/90→12/92	T4W / H4; Left / Right; Number of light functions: 3; 12 V / 24 V	1AG 003 434-211	10
25.272 DFK	198 kW		09/90→12/92		Headlight	
25.272 DFS, 25.272 DFLS	198 kW		09/90→12/92			
25.322 DF, 25.322 DFL	235 kW		09/90→12/92	H3; Depth [mm]: 76; Left / Right; Short distance lighting; 12 V / 24 V	1G4 004 480-001	25
25.322 DFK	235 kW		09/90→12/92		Worklight	
25.322 DFS, 25.322 DFLS	235 kW		09/90→12/92	10/90→ ; H3; Fitting Depth [mm]: 89; Left / Right; Transparent; Number of light functions: 1; + H 166 mm; 12 V / 24 V	1NE 006 300-051 Fog	7
25.322 FNL, 25.322 FNLL, 25.322 FVL	235 kW		09/90→12/92		Light	
25.322 FNLS, 25.322 FVLS	235 kW		09/90→12/92	P21W; Left / Right; Yellow; Number of light functions: 1; with lamp base	2BA 007 840-001	47
25.372 DF	249 kW		09/90→12/92		Indicator	
25.372 DF	272 kW		09/90→12/92	→ 12/91 ; P21W; Left / Right; Number of light functions: 1; with lamp base	2KA 003 389-081	44
25.372 DFK	249 kW		09/90→12/92		Licence Plate Light	
25.372 DFK	272 kW		09/90→12/92	T4W; Lateral Mounting; Red/Black; Number of light functions: 1; with lamp base	2XS 005 020-041	45
25.372 DFS	249 kW		09/90→12/92		Marker Lamp	
25.372 DFS, 25.372 DFLS	272 kW		09/90→12/92	→ 12/91 ; R10W; without lamp base; with screw	9BG 121 587-031	27
25.372 FNL, 25.372 FNLL, 25.372 FVL	272 kW		09/90→12/92		Housing, licence plate light	
25.422 DF	309 kW		09/90→12/92	→ 12/91 ; Additionally required articles (article numbers): 9EL 122 689-021 / 9EL 122 689-051; P21W / R10W; Left	9BG 130 945-001	26
25.422 DFK	309 kW		09/90→12/92		Housing, combination rearlight	
25.422 DFS, 25.422 DFLS	309 kW		09/90→12/92			
25.422 FNL, 25.422 FNLL	309 kW		09/90→12/92	→ 12/91 ; Additionally required articles (article numbers): 9EL 122 689-021 / 9EL 122 689-051; P21W / R10W; Right	9BG 130 946-001	26
25.422 FNLS, 25.422 FVLS	309 kW		09/90→12/92		Housing, combination rearlight	
25.502 DF	368 kW		09/90→12/92			
25.502 DFS	368 kW		09/90→12/92	→ 12/91 ; P21W / R10W; Left / Right; with reverse light / with reflector / with tail light / with indicator / with stop light / with fog taillight; Number of light functions: 6; without lamp base	9EL 122 689-021 Lens,	31
25.502 FNL	368 kW		09/90→12/92		combination rearlight	
26.272 DFA	198 kW		02/90→12/92			
26.272 DFAS	198 kW		02/90→12/92			
26.322 DFA	235 kW		02/90→12/92	→ 12/91 ; P21W / R10W; Left / Right; with reverse light / with reflector / with tail light / with indicator / with stop light; Number of light functions: 5; without lamp base	9EL 122 689-051 Lens,	32
26.322 DFAS	235 kW		02/90→12/92		combination rearlight	
26.372 DFA	272 kW		02/90→12/92			
26.372 DFAS	272 kW		02/90→12/92	T4W; Lateral Mounting; Red; without lamp base; with screws	9EL 132 215-011 Lens,	33
26.422 DFA	309 kW		02/90→12/92		marker lamp	
26.502 DFA	368 kW		02/90→12/92	H4; Left / Right; for right-hand traffic	9ES 120 743-001	4
26.502 DFAS	368 kW		02/90→12/92		Diffusing Lens, headlight	
35.272 VFK	198 kW		02/90→12/92			
26.272 DFAK	198 kW		02/90→12/92	T4W / H4; Left / Right; Number of light functions: 3; 12 V / 24 V	1AG 003 434-211	10
26.322 DFAK	235 kW		02/90→12/92		Headlight	
				H3; Depth [mm]: 76; Left / Right; Short distance lighting; 12 V / 24 V	1G4 004 480-001	25
					Worklight	
				10/90→ ; H3; Fitting Depth [mm]: 89; Left / Right; Transparent; Number of light functions: 1; + H 166 mm; 12 V / 24 V	1NE 006 300-051 Fog	7
					Light	
				P21W; Left / Right; Yellow; Number of light functions: 1; with lamp base	2BA 007 840-001	47
					Indicator	
				P21W; Left / Right; Number of light functions: 1; with lamp base	2KA 003 389-081	44
					Licence Plate Light	
				T4W; Lateral Mounting; Red/Black; Number of light functions: 1; with lamp base	2XS 005 020-041	45
					Marker Lamp	
				→ 12/91 ; R10W; without lamp base; with screw	9BG 121 587-031	27
					Housing, licence plate light	
				Additionally required articles (article numbers): 9EL 122 689-021 / 9EL 122 689-051; P21W / R10W; Left	9BG 130 945-001	26
					Housing, combination rearlight	
				Additionally required articles (article numbers): 9EL 122 689-021 / 9EL 122 689-051; P21W / R10W; Right	9BG 130 946-001	26
					Housing, combination rearlight	
				P21W / R10W; Left / Right; with reverse light / with reflector / with tail light / with indicator / with stop light / with fog taillight; Number of light functions: 6; without lamp base	9EL 122 689-021 Lens,	31
					combination rearlight	

Manufacturer - Model	Power	Displ.	Year of Constr.	Remark	Part Number	Page
MAN - F 90						07/86→
26.272 DFAK 26.322 DFAK	198 kW 235 kW		02/90→12/92 02/90→12/92	P21W / R10W; Left / Right; with reverse light / with reflector / with tail light / with indicator / with stop light; Number of light functions: 5; without lamp base T4W; Lateral Mounting; Red; without lamp base; with screws H4; Left / Right; for right-hand traffic	9EL 122 689-051 Lens, combination rearlight 9EL 132 215-011 Lens, marker lamp 9ES 120 743-001 Diffusing Lens, headlight	32 33 4
26.272 FNL,26.272 FNLL 26.322 FNL,26.322 FNLL 33.372 DFAK 33.372 DFK	198 kW 235 kW 272 kW 272 kW		03/91→05/95 03/91→05/95 01/91→06/96 01/91→06/96	T4W / H4; Left / Right; Number of light functions: 3; 12 V / 24 V H3; Depth [mm]: 76; Left / Right; Short distance lighting; 12 V / 24 V →04/93; H3; Fitting Depth [mm]: 89; Left / Right; Transparent; Number of light functions: 1; + H 166 mm; 12 V / 24 V P21W; Left / Right; Yellow; Number of light functions: 1; with lamp base →12/91; P21W; Left / Right; Number of light functions: 1; with lamp base T4W; Lateral Mounting; Red/Black; Number of light functions: 1; with lamp base →12/91; R10W; without lamp base; with screw →12/91; Additionally required articles (article numbers): 9EL 122 689-021 / 9EL 122 689-051; P21W / R10W; Left →12/91; Additionally required articles (article numbers): 9EL 122 689-021 / 9EL 122 689-051; P21W / R10W; Right →12/91; P21W / R10W; Left / Right; with reverse light / with reflector / with tail light / with indicator / with stop light / with fog taillight; Number of light functions: 6; without lamp base →12/91; P21W / R10W; Left / Right; with reverse light / with reflector / with tail light / with indicator / with stop light; Number of light functions: 5; without lamp base T4W; Lateral Mounting; Red; without lamp base; with screws H4; Left / Right; for right-hand traffic	1AG 003 434-211 Headlight 1G4 004 480-001 Worklight 1NE 006 300-051 Fog Light 2BA 007 840-001 Indicator 2KA 003 389-081 Licence Plate Light 2XS 005 020-041 Marker Lamp 9BG 121 587-031 Housing, licence plate light 9BG 130 945-001 Housing, combination rearlight 9BG 130 946-001 Housing, combination rearlight 9EL 122 689-021 Lens, combination rearlight 9EL 122 689-051 Lens, combination rearlight 9EL 132 215-011 Lens, marker lamp 9ES 120 743-001 Diffusing Lens, headlight	10 25 7 47 44 45 27 26 26 31 32 33 4
26.302 FNL, 26.302 FNLL, 26.302 FVL	220 kW		03/91→12/91	T4W / H4; Left / Right; Number of light functions: 3; 12 V / 24 V H3; Depth [mm]: 76; Left / Right; Short distance lighting; 12 V / 24 V H3; Fitting Depth [mm]: 89; Left / Right; Transparent; Number of light functions: 1; + H 166 mm; 12 V / 24 V P21W; Left / Right; Yellow; Number of light functions: 1; with lamp base P21W; Left / Right; Number of light functions: 1; with lamp base T4W; Lateral Mounting; Red/Black; Number of light functions: 1; with lamp base R10W; without lamp base; with screw Additionally required articles (article numbers): 9EL 122 689-021 / 9EL 122 689-051; P21W / R10W; Left Additionally required articles (article numbers): 9EL 122 689-021 / 9EL 122 689-051; P21W / R10W; Right P21W / R10W; Left / Right; with reverse light / with reflector / with tail light / with indicator / with stop light / with fog taillight; Number of light functions: 6; without lamp base P21W / R10W; Left / Right; with reverse light / with reflector / with tail light / with indicator / with stop light; Number of light functions: 5; without lamp base T4W; Lateral Mounting; Red; without lamp base; with screws H4; Left / Right; for right-hand traffic	1AG 003 434-211 Headlight 1G4 004 480-001 Worklight 1NE 006 300-051 Fog Light 2BA 007 840-001 Indicator 2KA 003 389-081 Licence Plate Light 2XS 005 020-041 Marker Lamp 9BG 121 587-031 Housing, licence plate light 9BG 130 945-001 Housing, combination rearlight 9BG 130 946-001 Housing, combination rearlight 9EL 122 689-021 Lens, combination rearlight 9EL 122 689-051 Lens, combination rearlight 9EL 132 215-011 Lens, marker lamp 9ES 120 743-001 Diffusing Lens, headlight	10 25 7 47 44 45 27 26 26 31 32 33 4
26.322 DFK 26.372 DFK 26.372 FNLS,26.372 FVLS	235 kW 272 kW 272 kW		02/92→06/96 01/92→06/96 01/92→06/96	T4W / H4; Left / Right; Number of light functions: 3; 12 V / 24 V	1AG 003 434-211 Headlight	10

Manufacturer - Model	Power	Displ.	Year of Constr.	Remark	Part Number	Page				
MAN - F 90						07/86→				
33.272 FVL	191 - 198 kW		10/92→04/95	H3; Depth [mm]: 76; Left / Right; Short distance lighting; 12 V / 24 V	1G4 004 480-001 Worklight	25				
				→04/93; H3; Fitting Depth [mm]: 89; Left / Right; Transparent; Number of light functions: 1; + H 166 mm; 12 V / 24 V	1NE 006 300-051 Fog Light	7				
				P21W; Left / Right; Yellow; Number of light functions: 1; with lamp base	2BA 007 840-001 Indicator	47				
				T4W; Lateral Mounting; Red/Black; Number of light functions: 1; with lamp base	2XS 005 020-041 Marker Lamp	45				
				T4W; Lateral Mounting; Red; without lamp base; with screws	9EL 132 215-011 Lens, marker lamp	33				
				H4; Left / Right; for right-hand traffic	9ES 120 743-001 Diffusing Lens, headlight	4				
26.422 DFAK 26.422 DFAS	309 kW		02/90→12/92	T4W / H4; Left / Right; Number of light functions: 3; 12 V / 24 V	1AG 003 434-211 Headlight	10				
				H3; Depth [mm]: 76; Left / Right; Short distance lighting; 12 V / 24 V	1G4 004 480-001 Worklight	25				
				→10/90→; H3; Fitting Depth [mm]: 89; Left / Right; Transparent; Number of light functions: 1; + H 166 mm; 12 V / 24 V	1NE 006 300-051 Fog Light	7				
				P21W; Left / Right; Yellow; Number of light functions: 1; with lamp base	2BA 007 840-001 Indicator	47				
				→12/91; P21W; Left / Right; Number of light functions: 1; with lamp base	2KA 003 389-081 Licence Plate Light	44				
				T4W; Lateral Mounting; Red/Black; Number of light functions: 1; with lamp base	2XS 005 020-041 Marker Lamp	45				
				→12/91; R10W; without lamp base; with screw	9BG 121 587-031 Housing, licence plate light	27				
				Additionally required articles (article numbers): 9EL 122 689-021 / 9EL 122 689-051; P21W / R10W; Left	9BG 130 945-001 Housing, combination rearlight	26				
				Additionally required articles (article numbers): 9EL 122 689-021 / 9EL 122 689-051; P21W / R10W; Right	9BG 130 946-001 Housing, combination rearlight	26				
				P21W / R10W; Left / Right; with reverse light / with reflector / with tail light / with indicator / with stop light / with fog taillight; Number of light functions: 6; without lamp base	9EL 122 689-021 Lens, combination rearlight	31				
				P21W / R10W; Left / Right; with reverse light / with reflector / with tail light / with indicator / with stop light; Number of light functions: 5; without lamp base	9EL 122 689-051 Lens, combination rearlight	32				
				T4W; Lateral Mounting; Red; without lamp base; with screws	9EL 132 215-011 Lens, marker lamp	33				
				H4; Left / Right; for right-hand traffic	9ES 120 743-001 Diffusing Lens, headlight	4				
				33.322 FVL 40.372 DF 40.372 DFA 40.422 DF 40.422 DFA	235 kW 272 kW 272 kW 309 kW 309 kW		09/91→06/96 12/91→06/96 12/91→06/96 12/91→06/96 12/91→06/96	T4W / H4; Left / Right; Number of light functions: 3; 12 V / 24 V	1AG 003 434-211 Headlight	10
								H3; Depth [mm]: 76; Left / Right; Short distance lighting; 12 V / 24 V	1G4 004 480-001 Worklight	25
→04/93; H3; Fitting Depth [mm]: 89; Left / Right; Transparent; Number of light functions: 1; + H 166 mm; 12 V / 24 V	1NE 006 300-051 Fog Light	7								
P21W; Left / Right; Yellow; Number of light functions: 1; with lamp base	2BA 007 840-001 Indicator	47								
T4W; Lateral Mounting; Red/Black; Number of light functions: 1; with lamp base	2XS 005 020-041 Marker Lamp	45								
→12/91; Additionally required articles (article numbers): 9EL 122 689-021 / 9EL 122 689-051; P21W / R10W; Left	9BG 130 945-001 Housing, combination rearlight	26								
→12/91; Additionally required articles (article numbers): 9EL 122 689-021 / 9EL 122 689-051; P21W / R10W; Right	9BG 130 946-001 Housing, combination rearlight	26								
→12/91; P21W / R10W; Left / Right; with reverse light / with reflector / with tail light / with indicator / with stop light / with fog taillight; Number of light functions: 6; without lamp base	9EL 122 689-021 Lens, combination rearlight	31								
→12/91; P21W / R10W; Left / Right; with reverse light / with reflector / with tail light / with indicator / with stop light; Number of light functions: 5; without lamp base	9EL 122 689-051 Lens, combination rearlight	32								
T4W; Lateral Mounting; Red; without lamp base; with screws	9EL 132 215-011 Lens, marker lamp	33								
H4; Left / Right; for right-hand traffic	9ES 120 743-001 Diffusing Lens, headlight	4								
35.372 VF	249 kW		02/90→04/95					T4W / H4; Left / Right; Number of light functions: 3; 12 V / 24 V	1AG 003 434-211 Headlight	10

Manufacturer - Model	Power	Displ.	Year of Constr.	Remark	Part Number	Page
MAN - F 90						07/86→
35.372 VF	249 kW		02/90→04/95	H3; Depth [mm]: 76; Left / Right; Short distance lighting; 12 V / 24 V	1G4 004 480-001 Worklight	25
				P21W; Left / Right; Yellow; Number of light functions: 1; with lamp base	2BA 007 840-001 Indicator	47
				→ 12/91 ; Additionally required articles (article numbers): 9EL 122 689-021 / 9EL 122 689-051; P21W / R10W; Left	9BG 130 945-001 Housing, combination rearlight	26
				→ 12/91 ; Additionally required articles (article numbers): 9EL 122 689-021 / 9EL 122 689-051; P21W / R10W; Right	9BG 130 946-001 Housing, combination rearlight	26
				→ 12/91 ; P21W / R10W; Left / Right; with reverse light / with reflector / with tail light / with indicator / with stop light / with fog taillight; Number of light functions: 6; without lamp base	9EL 122 689-021 Lens, 31 combination rearlight	
				→ 12/91 ; P21W / R10W; Left / Right; with reverse light / with reflector / with tail light / with indicator / with stop light; Number of light functions: 5; without lamp base	9EL 122 689-051 Lens, 32 combination rearlight	
				H4; Left / Right; for right-hand traffic	9ES 120 743-001 Diffusing Lens, headlight	4
MAN - F 2000						01/94→
18.273 F, FL, FLL	198 kW		06/94→	P21W / W5W / H7 / H7; Left; Number of light functions: 4; with bulbs; for vehicles without headlamp levelling	1D3 009 027-011 Headlight	12
19.233 FCNG	170 kW					
19.233 FKNG	170 kW					
19.273 F, FL, FLL	198 kW		01/94→	P21W / W5W / H7 / H7; Right; Number of light functions: 4; with bulbs; for vehicles without headlamp levelling	1D3 009 027-021 Headlight	13
19.273 FA	198 kW		01/94→			
19.273 FAK	198 kW		01/94→			
19.273 FK	198 kW		01/94→			
19.273 FS, 19.273 FLS	198 kW		01/94→12/95	P21W / W5W / H7 / H7; Left; Number of light functions: 4; with bulbs; for vehicles with headlamp levelling (electric)	1D3 009 027-031 Headlight	14
19.293 FAC	213 kW		01/94→			
19.293 FAK	213 kW		01/94→	P21W / W5W / H7 / H7; Right; Number of light functions: 4; with bulbs; for vehicles with headlamp levelling (electric)	1D3 009 027-041 Headlight	14
19.293 FAS	213 kW		01/94→			
19.293 FC, 19.293 FLC, 19.293 FLLC	213 kW		01/94→	T4W / H4; Left / Right; Number of light functions: 3; without bulbs; for vehicles without headlamp levelling	1EF 354 340-011 Headlight	15
19.293 FK, 19.293 FLK	213 kW		01/94→			
19.293 FS, 19.293 FLS, 19.293 FLLS	213 kW		01/94→	T4W / H4; Left / Right; Number of light functions: 3; without bulbs / with motor for headlamp levelling; for vehicles with headlamp levelling (electric)	1EF 354 340-021 Headlight	16
19.314 FAC	228 kW		05/01→			
19.314 FAK, FA-KI	228 kW		05/01→			
19.314 FAS	228 kW		06/98→	H3; Left; with high beam / with fog light; Number of light functions: 2; with bulbs	1NB 354 986-071 Spotlight	6, 24
19.314 FC, FLC, FLLC, FLLW, FRC, FLRC, FLLRC, FLL, FLLR, F-N	228 kW		06/98→	H3; Left; with high beam / with fog light; Number of light functions: 2; with bulbs	1NB 354 986-071 Fog Light	6, 24
19.314 FK, FLK, F-KI, FL-KI	228 kW		06/98→	H3; Right; with high beam / with fog light; Number of light functions: 2; with bulbs	1NB 354 986-081 Spotlight	6, 24
19.314 FS, FLS, FLLS, FRS, FLRS, FLLRS	228 kW		06/98→	H3; Right; with high beam / with fog light; Number of light functions: 2; with bulbs	1NB 354 986-081 Fog Light	6, 24
19.323 FAC	235 kW		01/94→12/95			
19.323 FAK	235 kW		01/94→12/95	P21W; Left / Right; Number of light functions: 1; with lamp base	2KA 003 389-081 Licence Plate Light	44
19.323 FAS	235 kW		01/94→12/95			
19.323 FC, 19.323 FLC, 19.323 FLLC	235 kW		01/94→12/95	Front; White; Number of light functions: 1	2PF 354 985-021 Position Light	45
19.323 FK, 19.323 FLK	235 kW		01/94→12/95			
19.323 FS, 19.323 FLS, 19.323 FLLS	235 kW		01/94→12/95	Yellow; LED; Number of light functions: 1	2PS 354 985-001 Side Marker Light	45
19.343 FAC	250 kW		01/94→			
19.343 FAK	250 kW		01/94→	P21W / R5W; Left / Right; Number of light functions: 8; 24 V; with lamp base	2VD 008 204-051 Combination Rearlight	36
19.343 FAS	250 kW		01/94→			
19.343 FC, 19.343 FLC, 19.343 FLLC	250 kW		01/94→	P21W / R5W; Left; Number of light functions: 9; 24 V; with lamp base	2VD 008 204-071 Combination Rearlight	37
19.343 FK, 19.343 FLK	250 kW		01/94→			
19.343 FS, 19.343 FLS, 19.343 FLLS	250 kW		01/94→	P21W / R5W; Left / Right; Number of light functions: 7; 24 V; with lamp base	2VP 008 204-041 Combination Rearlight	41
19.364 FAC	265 kW		06/98→			
19.364 FAK, FA-KI	265 kW		06/98→	P21W / R5W; Left / Right; Number of light functions: 8; 24 V; with lamp base	2VP 008 204-061 Combination Rearlight	42
19.364 FAS	265 kW		06/98→			
19.364 FC, FLC, FLLC, FLLW, FRC, FLRC, FLLRC, FLL, FLLR, F-N	265 kW		06/98→	T4W; Lateral Mounting; Red/Black; Number of light functions: 1; with lamp base	2XS 005 020-041 Marker Lamp	45
19.364 FK, FLK, F-KI, FL-KI	265 kW		06/98→	R10W; without lamp base; with screw	9BG 121 587-031 Housing, licence plate light	27
19.364 FS, FLS, FLLS, FRS, FLRS, FLLRS	265 kW		06/98→			
19.373 FAC	272 kW		01/94→	T4W; Lateral Mounting; Red; without lamp base; with screws	9EL 132 215-011 Lens, 33 marker lamp	
19.373 FAK, FA-KI	272 kW		01/94→			
19.373 FAS	272 kW		01/94→			
19.373 FC, FLC, FLLC, FRC, FLRC, F-NL	272 kW		01/94→	P21W / R5W; Left / Right; Number of light functions: 5; without lamp base; with screws	9EL 152 889-001 Lens, 33 combination rearlight	
19.373 FK, FLK, F-KI, FL-KI	272 kW		01/94→			
19.373 FS, FLS, FLLS, FRS, FLRS, FLLRS	272 kW		01/94→			

Manufacturer - Model	Power	Displ.	Year of Constr.	Remark	Part Number	Page
MAN - F 2000						01/94→
19.403 FAC	294 kW		01/94→	P21W / W5W / H7 / H7; Left; Number of light functions: 4; with bulbs; for vehicles without headlamp levelling	1D3 009 027-011 Headlight	12
19.403 FAK, FA-KI	294 kW		01/94→			
19.403 FAS	294 kW		01/94→			
19.403 FC, FLC, FLLC, FRC, FLRC, F-NL	294 kW		01/94→	P21W / W5W / H7 / H7; Right; Number of light functions: 4; with bulbs; for vehicles without headlamp levelling	1D3 009 027-021 Headlight	13
19.403 FK, FLK, F-KI, FL-KI	294 kW		01/94→			
19.403 FS, FLS, FLLS, FRS, FLRS, FLLRS	294 kW		01/94→	P21W / W5W / H7 / H7; Left; Number of light functions: 4; with bulbs; for vehicles with headlamp levelling (electric)	1D3 009 027-031 Headlight	14
19.414 FAC	301 kW		06/98→			
19.414 FAK, FA-KI	301 kW		06/98→			
19.414 FAS	301 kW		06/98→			
19.414 FC, FLC, FLLC, FRC, FLRC, FLLRC, FLL, FLLR, F-NL	301 kW		06/98→	T4W / H4; Left / Right; Number of light functions: 3; without bulbs; for vehicles without headlamp levelling	1EF 354 340-011 Headlight	15
19.414 FK, FLK, F-KI, FL-KI	301 kW		06/98→			
19.414 FS, FLS, FLLS, FRS, FLRS, FLLRS	301 kW		06/98→	T4W / H4; Left / Right; Number of light functions: 3; without bulbs / with motor for headlamp levelling; for vehicles with headlamp levelling (electric)	1EF 354 340-021 Headlight	16
19.423 FAC	309 kW		01/94→12/95			
19.423 FAK, FA-KI	309 kW		01/94→			
19.423 FAS	309 kW		01/94→12/95	H3; Left; with high beam / with fog light; Number of light functions: 2; with bulbs	1NB 354 986-071 Spotlight	6, 24
19.423 FC, FLC, FLLC, F-NL	309 kW		01/94→			
19.423 FK, FLK, F-KI, FL-KI	309 kW		01/94→	H3; Left; with high beam / with fog light; Number of light functions: 2; with bulbs	1NB 354 986-071 Fog Light	6, 24
19.423 FS, FLS, FLLS	309 kW		01/94→			
19.463 FAC	338 kW		01/94→			
19.463 FAK, FA-KI	338 kW		01/94→	H3; Right; with high beam / with fog light; Number of light functions: 2; with bulbs	1NB 354 986-081 Spotlight	6, 24
19.463 FAS	338 kW		01/94→			
19.463 FC, FLC, FLLC, FRC, FLRC, F-NL	338 kW		01/94→	H3; Right; with high beam / with fog light; Number of light functions: 2; with bulbs	1NB 354 986-081 Fog Light	6, 24
19.463 FK, FLK, F-KI, FL-KI	338 kW		01/94→			
19.463 FS, FLS, FLLS, FRS, FLRS, FLLRS	338 kW		01/94→	P21W; Left / Right; Number of light functions: 1; with lamp base	2KA 003 389-081 Licence Plate Light	44
19.464 FAC	338 kW		06/98→			
19.464 FAK, FA-KI	338 kW		06/98→			
19.464 FAS	338 kW		06/98→			
19.464 FC, FLC, FLLC, FLL, FRC, FLLR, FLLRC, FLLW, F-NL	338 kW		06/98→	Front; White; Number of light functions: 1	2PF 354 985-021 Position Light	45
19.464 FK, FLK, F-KI, FL-KI	338 kW		06/98→			
19.464 FS, FLS, FLLS, FRS, FLRS, FLLRS	338 kW		06/98→	Yellow; LED; Number of light functions: 1	2PS 354 985-001 Side Marker Light	45
19.603 FLS, 19604 FLS	441 kW		04/96→			
23.293 FNLLC	213 kW		01/94→	P21W / R5W; Left / Right; Number of light functions: 8; 24 V; with lamp base	2VD 008 204-051 Combination Rearlight	36
23.314 FNLLC	228 kW		05/01→			
23.343 FNLLC	250 kW		01/94→	P21W / R5W; Left; Number of light functions: 9; 24 V; with lamp base	2VD 008 204-071 Combination Rearlight	37
23.364 FNLLC	265 kW		05/01→			
23.403 FNLLC	294 kW		01/94→	P21W / R5W; Left / Right; Number of light functions: 7; 24 V; with lamp base	2VP 008 204-041 Combination Rearlight	41
23.414 FNLLC	301 kW		05/01→			
23.463 FNLLC	338 kW		01/94→	T4W; Lateral Mounting; Red/Black; Number of light functions: 1; with lamp base	2XS 005 020-041 Marker Lamp	45
23.464 FNLLC	338 kW		05/01→			
24.273 FNLLC	198 kW		01/94→12/95	R10W; without lamp base; with screw	9BG 121 587-031 Housing, licence plate light	27
24.293 FNLLC	213 kW		01/94→			
24.314 FNLLRC	228 kW		05/01→	T4W; Lateral Mounting; Red; without lamp base; with screws	9EL 132 215-011 Lens, marker lamp	33
24.323 FNLLC	235 kW		01/94→12/95			
24.343 FNLLC	250 kW		01/94→	P21W / R5W; Left / Right; Number of light functions: 5; without lamp base; with screws	9EL 152 889-001 Lens, combination rearlight	33
24.364 FNLLRC	265 kW		05/01→			
24.373 FNLLC	272 kW		01/94→12/95			
24.403 FNLLC	294 kW		01/94→			
24.414 FNLLRC	301 kW		05/01→			
24.423 FNLLC	309 kW		01/94→12/95			
24.463 FNLLC	338 kW		01/94→			
24.464 FNLLRC	338 kW		05/01→			
26.233 FVL CNG	170 kW		09/96→			
26.233 FVL-KO	170 kW		03/00→			
26.273 DFC,26.273 DFLC	198 kW		01/94→12/95			
26.273 DFK,26.273 DFLK	198 kW		01/94→12/95			
26.273 DFS,26.273 DFLS	198 kW		01/94→12/95			
26.273 FNLC,26.273 FNLLC,	198 kW		01/94→12/95			
26.273 FVLC						
26.273 FNLS,26.273 FVLS	198 kW		01/94→12/95			
26.293 DFC,26.293 DFLC	213 kW		01/94→			
26.293 DFK,26.293 DFLK	213 kW		01/94→			
26.293 DFS,26.293 DFLS	213 kW		01/94→			
26.293 FNLC,26.293 FNLLC,	213 kW		01/94→			
26.293 FVLC						
26.293 FNLS,26.293 FVLS	213 kW		01/94→			
26.314 DFC, DFLC	228 kW		05/01→			
26.314 DFK, DFLK	228 kW		05/01→			
26.314 DFS, DFLS	228 kW		05/01→			
26.314 DF-TM	228 kW		05/01→			
26.314 FNLC, FNLLC, FNLLRC, FNLLW, FVLC	228 kW		05/01→			
26.314 FNLS	228 kW		05/01→			
26.314 FVL-KO	228 kW		05/01→			

Manufacturer - Model	Power	Displ.	Year of Constr.	Remark	Part Number	Page
MAN - F 2000						01/94→
26.314 FVLS, FVLR	228 kW		05/01→	P21W / W5W / H7 / H7; Left; Number of light functions: 4; with bulbs; for vehicles without headlamp levelling	1D3 009 027-011 Headlight	12
26.323 DFC,26.323 DFLC	235 kW		01/94→12/95			
26.323 DFK,26.323 DFLK	235 kW		01/94→12/95			
26.323 DFS,26.323 DFSL	235 kW		01/94→12/95	P21W / W5W / H7 / H7; Right; Number of light functions: 4; with bulbs; for vehicles without headlamp levelling	1D3 009 027-021 Headlight	13
26.323 FNLC,26.323 FNLLC, 26.323 FVLC	235 kW		01/94→12/95			
26.323 FNLS,26.323 FVLS	235 kW		01/94→12/95	P21W / W5W / H7 / H7; Left; Number of light functions: 4; with bulbs; for vehicles with headlamp levelling (electric)	1D3 009 027-031 Headlight	14
26.343 DFC,26.343 DFLC	250 kW		01/94→			
26.343 DFK,26.343 DFLK	250 kW		01/94→			
26.343 DFS,26.343 DFSL	250 kW		01/94→	P21W / W5W / H7 / H7; Right; Number of light functions: 4; with bulbs; for vehicles with headlamp levelling (electric)	1D3 009 027-041 Headlight	14
26.343 FNLC,26.343 FNLLC, 26.343 FVLC	250 kW		01/94→			
26.343 FNLS,26.343 FVLS	250 kW		01/94→	T4W / H4; Left / Right; Number of light functions: 3; without bulbs; for vehicles without headlamp levelling	1EF 354 340-011 Headlight	15
26.364 DFC, DFLC	265 kW		05/01→			
26.364 DFK, DFLK	265 kW		05/01→			
26.364 DFS, DFSL	265 kW		05/01→	T4W / H4; Left / Right; Number of light functions: 3; without bulbs / with motor for headlamp levelling; for vehicles with headlamp levelling (electric)	1EF 354 340-021 Headlight	16
26.364 DF-TM	265 kW		05/01→			
26.364 FNLC, FNLLC, FNLLRC, FNLLW, FVLC	265 kW		05/01→			
26.364 FNLS	265 kW		05/01→	H3; Left; with high beam / with fog light; Number of light functions: 2; with bulbs	1NB 354 986-071 Spotlight	6, 24
26.364 FVL-KO	265 kW		05/01→	H3; Left; with high beam / with fog light; Number of light functions: 2; with bulbs	1NB 354 986-071 Fog Light	6, 24
26.364 FVLS, FVLR	265 kW		05/01→			
26.373 DFC,26.373 DFLC	272 kW		01/94→12/95	H3; Right; with high beam / with fog light; Number of light functions: 2; with bulbs	1NB 354 986-081 Spotlight	6, 24
26.373 DFK,26.373 DFLK	272 kW		01/94→12/95			
26.373 DFS,26.373 DFSL	272 kW		01/94→12/95	H3; Right; with high beam / with fog light; Number of light functions: 2; with bulbs	1NB 354 986-081 Fog Light	6, 24
26.373 FNLC,26.373 FNLLC, 26.373 FVLC	272 kW		01/94→12/95			
26.373 FNLS,26.373 FVLS	272 kW		01/94→12/95	P21W; Left / Right; Number of light functions: 1; with lamp base	2KA 003 389-081 Licence Plate Light	44
26.403 DFC,26.403 DFLC	294 kW		01/94→			
26.403 DFK,26.403 DFLK	294 kW		01/94→	Front; White; Number of light functions: 1	2PF 354 985-021 Position Light	45
26.403 DFS,26.403 DFSL	294 kW		01/94→			
26.403 FNLC,26.403 FNLLC, 26.403 FVLC	294 kW		01/94→	Yellow; LED; Number of light functions: 1	2PS 354 985-001 Side Marker Light	45
26.403 FNLS,26.403 FVLS	294 kW		01/94→			
26.414 DFC, DFLC	301 kW		05/01→	P21W / R5W; Left / Right; Number of light functions: 8; 24 V; with lamp base	2VD 008 204-051 Combination Rearlight	36
26.414 DFK, DFLK	301 kW		05/01→			
26.414 DFS, DFSL	301 kW		05/01→	P21W / R5W; Left; Number of light functions: 9; 24 V; with lamp base	2VD 008 204-071 Combination Rearlight	37
26.414 DF-TM	301 kW		05/01→			
26.414 FNLC, FNLLC, FNLLRC, FNLLW, FVLC	301 kW		05/01→	P21W / R5W; Left / Right; Number of light functions: 7; 24 V; with lamp base	2VP 008 204-041 Combination Rearlight	41
26.414 FNLS	301 kW		05/01→			
26.414 FVL-KO	301 kW		05/01→	P21W / R5W; Left / Right; Number of light functions: 8; 24 V; with lamp base	2VP 008 204-061 Combination Rearlight	42
26.414 FVLS, FVLR	301 kW		05/01→	T4W; Lateral Mounting; Red/Black; Number of light functions: 1; with lamp base	2XS 005 020-041 Marker Lamp	45
26.423 DFC,26.423 DFLC	309 kW		01/94→12/95			
26.423 DFK,26.423 DFLK	309 kW		01/94→12/95	R10W; without lamp base; with screw	9BG 121 587-031 Housing, licence plate light	27
26.423 DFS,26.423 DFSL	309 kW		01/94→12/95			
26.423 FNLC,26.423 FNLLC, 26.423 FVLC	309 kW		01/94→12/95			
26.423 FNLS,26.423 FVLS	309 kW		01/94→12/95	T4W; Lateral Mounting; Red; without lamp base; with screws	9EL 132 215-011 Lens, marker lamp	33
26.463 DFC, DFLC	338 kW		01/94→			
26.463 DFK,26.463 DFLK	338 kW		01/94→			
26.463 DFS,26.463 DFSL	338 kW		01/94→	P21W / R5W; Left / Right; Number of light functions: 5; without lamp base; with screws	9EL 152 889-001 Lens, combination rearlight	33
26.463 FNLC, FNLLC, FVLC	338 kW		01/94→			
26.463 FNLS,26.463 FVLS	338 kW		01/94→			
26.464 DFC, DFLC	338 kW		05/01→			
26.464 DFK, DFLK	338 kW		05/01→			
26.464 DFS, DFSL	338 kW		05/01→			
26.464 DF-TM	338 kW		05/01→			
26.464 FNLC, FNLLC, FNLLW, FVLC	338 kW		05/01→			
26.464 FNLS	338 kW		05/01→			
26.464 FVL-KO	338 kW		05/01→			
26.464 FVLS, FVLR	338 kW		05/01→			
26.603 DFC, DFLC	441 kW		06/96→			
26.603 DFK, DFLK	441 kW		06/96→			
26.603 DFS, DFSL	441 kW		06/96→			
26.604 DFSL	441 kW		04/00→			
27.273 DFAC	198 kW		01/94→12/95			
27.273 DFAK	198 kW		01/94→12/95			
27.273 DFAS	198 kW		01/94→12/95			
27.273 DFC	198 kW		01/94→12/95			
27.273 DFK	198 kW		01/94→12/95			
27.273 DFS	198 kW		01/94→12/95			
27.293 DFAC	213 kW		01/94→			
27.293 DFAK	213 kW		01/94→			
27.293 DFAS	213 kW		01/94→			
27.293 DFC	213 kW		01/94→			
27.293 DFK	213 kW		01/94→			
27.293 DFS	213 kW		01/94→			
27.314 DFAC	228 kW		05/01→			
27.314 DFAK, DFA-KI	228 kW		05/01→			

Manufacturer - Model	Power	Displ.	Year of Constr.	Remark	Part Number	Page
MAN - F 2000						01/94→
27.314 DFAS	228 kW		05/01→	P21W / W5W / H7 / H7; Left; Number of light functions: 4; with bulbs; for vehicles without headlamp levelling	1D3 009 027-011 Headlight	12
27.314 DFC	228 kW		05/01→			
27.314 DFK, DF-KI	228 kW		05/01→			
27.314 DFS	228 kW		05/01→	P21W / W5W / H7 / H7; Right; Number of light functions: 4; with bulbs; for vehicles without headlamp levelling	1D3 009 027-021 Headlight	13
27.314 DF-TM	228 kW		05/01→			
27.314 FVL	228 kW		06/98→			
27.323 DFAC	235 kW		01/94→12/95	P21W / W5W / H7 / H7; Left; Number of light functions: 4; with bulbs; for vehicles with headlamp levelling (electric)	1D3 009 027-031 Headlight	14
27.323 DFAK, DFA-KI	235 kW		01/94→			
27.323 DFAS	235 kW		01/94→12/95			
27.323 DFC	235 kW		01/94→12/95	P21W / W5W / H7 / H7; Right; Number of light functions: 4; with bulbs; for vehicles with headlamp levelling (electric)	1D3 009 027-041 Headlight	14
27.323 DFK, DF-KI	235 kW		01/94→			
27.323 DFS	235 kW		01/94→12/95			
27.343 DFAC	250 kW		01/94→	T4W / H4; Left / Right; Number of light functions: 3; without bulbs; for vehicles without headlamp levelling	1EF 354 340-011 Headlight	15
27.343 DFAK	250 kW		01/94→			
27.343 DFAS	250 kW		01/94→			
27.343 DFC	250 kW		01/94→	T4W / H4; Left / Right; Number of light functions: 3; without bulbs / with motor for headlamp levelling; for vehicles with headlamp levelling (electric)	1EF 354 340-021 Headlight	16
27.343 DFK	250 kW		01/94→			
27.343 DFS	250 kW		01/94→			
27.364 DFAC	265 kW		05/01→	H3; Left; with high beam / with fog light; Number of light functions: 2; with bulbs	1NB 354 986-071 Spotlight	6, 24
27.364 DFAK, DFA-KI	265 kW		05/01→			
27.364 DFAS	265 kW		05/01→	H3; Left; with high beam / with fog light; Number of light functions: 2; with bulbs	1NB 354 986-071 Fog Light	6, 24
27.364 DFC	265 kW		05/01→			
27.364 DFK, DF-KI	265 kW		05/01→	H3; Right; with high beam / with fog light; Number of light functions: 2; with bulbs	1NB 354 986-081 Spotlight	6, 24
27.364 DFS	265 kW		05/01→			
27.364 DF-TM	265 kW		05/01→			
27.364 FVL	265 kW		06/98→	H3; Right; with high beam / with fog light; Number of light functions: 2; with bulbs	1NB 354 986-081 Fog Light	6, 24
27.373 DFAC	272 kW		01/94→			
27.373 DFAK, DFA-KI	272 kW		01/94→	P21W; Left / Right; Number of light functions: 1; with lamp base	2KA 003 389-081 Licence Plate Light	44
27.373 DFAS	272 kW		01/94→			
27.373 DFC	272 kW		01/94→	Front; White; Number of light functions: 1	2PF 354 985-021 Position Light	45
27.373 DFK, DF-KI	272 kW		01/94→			
27.373 DFS	272 kW		01/94→	Yellow; LED; Number of light functions: 1	2PS 354 985-001 Side Marker Light	45
27.373 DF-TM	272 kW		07/00→			
27.403 DFAC	294 kW		01/94→			
27.403 DFAK, DFA-KI	294 kW		01/94→	P21W / R5W; Left / Right; Number of light functions: 8; 24 V; with lamp base	2VD 008 204-051 Combination Rearlight	36
27.403 DFAS	294 kW		01/94→			
27.403 DFC	294 kW		01/94→	P21W / R5W; Left; Number of light functions: 9; 24 V; with lamp base	2VD 008 204-071 Combination Rearlight	37
27.403 DFK, DF-KI	294 kW		01/94→			
27.403 DFS	294 kW		01/94→			
27.403 DF-TM	294 kW		07/00→	P21W / R5W; Left / Right; Number of light functions: 7; 24 V; with lamp base	2VP 008 204-041 Combination Rearlight	41
27.414 DFAC	301 kW		05/01→			
27.414 DFAK, DFA-KI	301 kW		05/01→	P21W / R5W; Left / Right; Number of light functions: 8; 24 V; with lamp base	2VP 008 204-061 Combination Rearlight	42
27.414 DFAS	301 kW		05/01→			
27.414 DFC	301 kW		05/01→	T4W; Lateral Mounting; Red/Black; Number of light functions: 1; with lamp base	2XS 005 020-041 Marker Lamp	45
27.414 DFK, DF-KI	301 kW		05/01→			
27.414 DFS	301 kW		05/01→	R10W; without lamp base; with screw	9BG 121 587-031 Housing, licence plate light	27
27.414 DF-TM	301 kW		05/01→			
27.414 FVL	301 kW		06/98→			
27.423 DFAC	309 kW		01/94→	T4W; Lateral Mounting; Red; without lamp base; with screws	9EL 132 215-011 Lens, marker lamp	33
27.423 DFAK, DFA-KI	309 kW		01/94→			
27.423 DFAS	309 kW		01/94→12/95			
27.423 DFC	309 kW		01/94→	P21W / R5W; Left / Right; Number of light functions: 5; without lamp base; with screws	9EL 152 889-001 Lens, combination rearlight	33
27.423 DFK, DF-KI	309 kW		01/94→			
27.423 DFS	309 kW		01/94→			
27.423 DF-TM	309 kW		07/00→			
27.463 DFAC	338 kW		01/94→			
27.463 DFAK, DFA-KI	338 kW		01/94→			
27.463 DFAS	338 kW		01/94→			
27.463 DFC	338 kW		01/94→			
27.463 DFK, DF-KI	338 kW		01/94→			
27.463 DFS	338 kW		01/94→			
27.463 DF-TM	338 kW		07/00→			
27.464 DFAC	338 kW		05/01→			
27.464 DFAK, DFA-KI	338 kW		05/01→			
27.464 DFAS	338 kW		05/01→			
27.464 DFC	338 kW		01/94→			
27.464 DFK, DF-KI	338 kW		01/94→			
27.464 DFS	338 kW		01/94→			
27.464 DF-TM	338 kW		07/00→			
27.464 FVL	338 kW		06/98→			
27.603 DFAS	441 kW		01/96→			
27.603 DFS	441 kW		01/96→			
32.293 VFC	213 kW		08/95→			
32.314 VF, VFC	228 kW		05/01→			
32.314 VFK, VF-HK	228 kW		05/01→			
32.314 VF-TM	228 kW		05/01→			
32.343 VFC	250 kW		08/95→			
32.343 VFK	250 kW		08/95→			
32.364 VF, VFC	265 kW		05/01→			
32.364 VFK, VF-HK	265 kW		05/01→			
32.364 VF-TM	265 kW		05/01→			

Manufacturer - Model	Power	Displ.	Year of Constr.	Remark	Part Number	Page
MAN - F 2000						01/94→
32.403 VFC	294 kW		08/95→	P21W / W5W / H7 / H7; Left; Number of light functions: 4; with bulbs; for vehicles without headlamp levelling	1D3 009 027-011 Headlight	12
32.403 VFK	294 kW		08/95→			
32.414 VF, VFC	301 kW		05/01→			
32.414 VFK, VF-HK	301 kW		05/01→	P21W / W5W / H7 / H7; Right; Number of light functions: 4; with bulbs; for vehicles without headlamp levelling	1D3 009 027-021 Headlight	13
32.414 VF-TM	301 kW		05/01→			
32.463 VFC	338 kW		08/95→			
32.463 VFK	338 kW		08/95→	P21W / W5W / H7 / H7; Left; Number of light functions: 4; with bulbs; for vehicles with headlamp levelling (electric)	1D3 009 027-031 Headlight	14
32.464 VF, VFC	338 kW		05/01→			
32.464 VFK, VF-HK	338 kW		05/01→			
32.464 VF-TM	338 kW		05/01→	P21W / W5W / H7 / H7; Right; Number of light functions: 4; with bulbs; for vehicles with headlamp levelling (electric)	1D3 009 027-041 Headlight	14
33.323 DFAC	235 kW		01/94→12/95			
33.323 DFAK	235 kW		01/94→12/95	T4W / H4; Left / Right; Number of light functions: 3; without bulbs; for vehicles without headlamp levelling	1EF 354 340-011 Headlight	15
33.323 DFAS	235 kW		01/94→12/95			
33.323 DFC	235 kW		01/94→12/95			
33.323 DFK	235 kW		01/94→12/95	T4W / H4; Left / Right; Number of light functions: 3; without bulbs / with motor for headlamp levelling; for vehicles with headlamp levelling (electric)	1EF 354 340-021 Headlight	16
33.323 DFS	235 kW		01/94→12/95			
33.343 DFAC	250 kW		01/94→			
33.343 DFAK	250 kW		01/94→	H3; Left; with high beam / with fog light; Number of light functions: 2; with bulbs	1NB 354 986-071 Spotlight	6, 24
33.343 DFAS	250 kW		01/94→			
33.343 DFC	250 kW		01/94→			
33.343 DFK	250 kW		01/94→	H3; Left; with high beam / with fog light; Number of light functions: 2; with bulbs	1NB 354 986-071 Fog Light	6, 24
33.343 DFS	250 kW		01/94→			
33.364 DFAC	265 kW		05/01→	H3; Right; with high beam / with fog light; Number of light functions: 2; with bulbs	1NB 354 986-081 Spotlight	6, 24
33.364 DFAK, DFA-KI	265 kW		05/01→			
33.364 DFAS	265 kW		05/01→			
33.364 DFC	265 kW		05/01→	H3; Right; with high beam / with fog light; Number of light functions: 2; with bulbs	1NB 354 986-081 Fog Light	6, 24
33.364 DFK, DF-KI	265 kW		05/01→			
33.364 DFS, DFRS	265 kW		05/01→	P21W; Left / Right; Number of light functions: 1; with lamp base	2KA 003 389-081 Licence Plate Light	44
33.373 DFAC	272 kW		01/94→			
33.373 DFAK, DFA-KI	272 kW		01/94→	Front; White; Number of light functions: 1	2PF 354 985-021 Position Light	45
33.373 DFAS	272 kW		01/94→			
33.373 DFC	272 kW		01/94→	Yellow; LED; Number of light functions: 1	2PS 354 985-001 Side Marker Light	45
33.373 DFK, DF-KI	272 kW		01/94→			
33.373 DFS, DFRS	272 kW		01/94→			
33.403 DFAC	294 kW		01/94→	P21W / R5W; Left / Right; Number of light functions: 8; 24 V; with lamp base	2VD 008 204-051 Combination Rearlight	36
33.403 DFAK, DFA-KI	294 kW		01/94→			
33.403 DFAS	294 kW		01/94→	P21W / R5W; Left; Number of light functions: 9; 24 V; with lamp base	2VD 008 204-071 Combination Rearlight	37
33.403 DFC	294 kW		01/94→			
33.403 DFK, DF-KI	294 kW		01/94→	P21W / R5W; Left / Right; Number of light functions: 7; 24 V; with lamp base	2VP 008 204-041 Combination Rearlight	41
33.403 DFS, DFRS	294 kW		01/94→			
33.414 DFAC	301 kW		05/01→	P21W / R5W; Left / Right; Number of light functions: 8; 24 V; with lamp base	2VP 008 204-061 Combination Rearlight	42
33.414 DFAK, DFA-KI	301 kW		05/01→			
33.414 DFAS	301 kW		05/01→	T4W; Lateral Mounting; Red/Black; Number of light functions: 1; with lamp base	2XS 005 020-041 Marker Lamp	45
33.414 DFC	301 kW		05/01→			
33.414 DFK, DF-KI	301 kW		05/01→	R10W; without lamp base; with screw	9BG 121 587-031 Housing, licence plate light	27
33.414 DFS, DFRS	301 kW		05/01→			
33.423 DFAC	309 kW		01/94→			
33.423 DFAK, DFA-KI	309 kW		01/94→	T4W; Lateral Mounting; Red; without lamp base; with screws	9EL 132 215-011 Lens, marker lamp	33
33.423 DFAS	309 kW		01/94→			
33.423 DFC	309 kW		01/94→			
33.423 DFK, DF-KI	309 kW		01/94→	P21W / R5W; Left / Right; Number of light functions: 5; without lamp base; with screws	9EL 152 889-001 Lens, combination rearlight	33
33.423 DFS, DFRS	309 kW		01/94→			
33.463 DFAC	338 kW		01/94→			
33.463 DFAK, DFA-KI	338 kW		01/94→			
33.463 DFAS	338 kW		01/94→			
33.463 DFC	338 kW		01/94→			
33.463 DFK, DF-KI	338 kW		01/94→			
33.463 DFS, DFRS	338 kW		01/94→			
33.464 DFAC	338 kW		05/01→			
33.464 DFAK, DFA-KI	338 kW		05/01→			
33.464 DFAS	338 kW		05/01→			
33.464 DFC	338 kW		05/01→			
33.464 DFK, DF-KI	338 kW		05/01→			
33.464 DFS, DFRS	338 kW		05/01→			
33.603 DFAC	441 kW		06/96→			
33.603 DFAS	441 kW		06/96→			
33.603 DFC	441 kW		06/96→			
33.603 DFS	441 kW		06/96→			
35.314 VF-TM	228 kW		03/02→			
35.343 VFC	250 kW		08/95→			
35.343 VFK	250 kW		08/95→			
35.364 VF, VFC, VFRC	265 kW		05/01→			
35.364 VFK, VF-HK, VF-KI	265 kW		03/02→			
35.364 VF-TM	265 kW		03/02→			
35.373 VF, VFC, VFRC	272 kW		05/01→			
35.373 VFK, VF-HK, VF-KI	272 kW		03/02→			
35.403 VF, VFC, VFRC	294 kW		08/95→			
35.403 VFK, VF-HK, VF-KI	294 kW		03/02→			
35.414 VF, VFC, VFRC	301 kW		05/01→			
35.414 VFK, VF-HK, VF-KI	301 kW		03/02→			
35.414 VF-TM	301 kW		03/02→			

Manufacturer - Model	Power	Displ.	Year of Constr.	Remark	Part Number	Page
MAN - F 2000						01/94→
35.423 VF, VFC	309 kW		05/01→	P21W / W5W / H7 / H7; Left; Number of light functions: 4; with bulbs; for vehicles without headlamp levelling	1D3 009 027-011 Headlight	12
35.423 VFK, VF-HK, VF-KI	309 kW		03/02→			
35.463 VF, VFC, VFRC	338 kW		08/95→			
35.463 VFK, VF-HK, VF-KI	338 kW		08/95→	P21W / W5W / H7 / H7; Right; Number of light functions: 4; with bulbs; for vehicles without headlamp levelling	1D3 009 027-021 Headlight	13
35.464 VF, VFC, VFRC	338 kW		05/01→			
35.464 VFK, VF-HK, VF-KI	338 kW		03/02→			
35.464 VF-TM	338 kW		03/02→	P21W / W5W / H7 / H7; Left; Number of light functions: 4; with bulbs; for vehicles with headlamp levelling (electric)	1D3 009 027-031 Headlight	14
37.414 VFA	301 kW		06/98→			
37.464 VFA	338 kW		06/98→			
40.273 DFAK	198 kW		01/94→	P21W / W5W / H7 / H7; Right; Number of light functions: 4; with bulbs; for vehicles with headlamp levelling (electric)	1D3 009 027-041 Headlight	14
40.273 DFK	198 kW		01/94→			
40.373 DFAK	272 kW		05/01→	T4W / H4; Left / Right; Number of light functions: 3; without bulbs; for vehicles without headlamp levelling	1EF 354 340-011 Headlight	15
40.373 DFK	272 kW		05/01→			
40.403 DFAK	294 kW		01/94→			
40.403 DFAS	294 kW		01/94→	T4W / H4; Left / Right; Number of light functions: 3; without bulbs / with motor for headlamp levelling; for vehicles with headlamp levelling (electric)	1EF 354 340-021 Headlight	16
40.403 DFK	294 kW		01/94→			
40.403 DFS	294 kW		01/94→			
40.414 DFAK	301 kW		05/01→			
40.414 DFK	301 kW		05/01→	H3; Left; with high beam / with fog light; Number of light functions: 2; with bulbs	1NB 354 986-071 Spotlight	6, 24
40.423 DFAK	309 kW		05/01→			
40.423 DFK	309 kW		05/01→	H3; Left; with high beam / with fog light; Number of light functions: 2; with bulbs	1NB 354 986-071 Fog Light	6, 24
40.463 DFAK	338 kW		01/94→			
40.463 DFAS	338 kW		01/94→	H3; Right; with high beam / with fog light; Number of light functions: 2; with bulbs	1NB 354 986-081 Spotlight	6, 24
40.463 DFK	338 kW		01/94→			
40.463 DFS	338 kW		01/94→			
41.343 VFC	250 kW		08/95→			
41.343 VFK	250 kW		08/95→			
41.364 VF, VFC, VFRC	265 kW		05/01→			
41.364 VFK, VF-HK, VF-KI	265 kW		03/02→	P21W; Left / Right; Number of light functions: 1; with lamp base	2KA 003 389-081 Licence Plate Light	44
41.373 VF, VFC, VFRC	272 kW		05/01→			
41.373 VFK, VF-HK, VF-KI	272 kW		03/02→	Front; White; Number of light functions: 1	2PF 354 985-021 Position Light	45
41.403 VF, VFC, VFRC	294 kW		08/95→			
41.403 VFK, VF-HK, VF-KI	294 kW		08/95→	Yellow; LED; Number of light functions: 1	2PS 354 985-001 Side Marker Light	45
41.414 VF, VFC, VFRC	301 kW		05/01→			
41.414 VFK, VF-HK, VF-KI	301 kW		03/02→	P21W / R5W; Left / Right; Number of light functions: 8; 24 V; with lamp base	2VD 008 204-051 Combination Rearlight	36
41.423 VF, VFC, VFRC	309 kW		05/01→			
41.423 VFK, VF-HK, VF-KI	309 kW		03/02→	P21W / R5W; Left; Number of light functions: 9; 24 V; with lamp base	2VD 008 204-071 Combination Rearlight	37
41.463 VF, VFC, VFRC	338 kW		08/95→			
41.463 VFK, VF-HK, VF-KI	338 kW		08/95→	P21W / R5W; Left / Right; Number of light functions: 7; 24 V; with lamp base	2VP 008 204-041 Combination Rearlight	41
41.464 VF, VFC, VFRC	338 kW		06/98→			
41.464 VFK, VF-HK, VF-KI	338 kW		03/02→	P21W / R5W; Left / Right; Number of light functions: 8; 24 V; with lamp base	2VP 008 204-061 Combination Rearlight	42
				T4W; Lateral Mounting; Red/Black; Number of light functions: 1; with lamp base	2XS 005 020-041 Marker Lamp	45
				R10W; without lamp base; with screw	9BG 121 587-031 Housing, licence plate light	27
				T4W; Lateral Mounting; Red; without lamp base; with screws	9EL 132 215-011 Lens, marker lamp	33
				P21W / R5W; Left / Right; Number of light functions: 5; without lamp base; with screws	9EL 152 889-001 Lens, combination rearlight	33
MAN - G 90						09/87→05/95
10.150 F, 10.150 FL	92 kW		05/90→10/93	H3; Depth [mm]: 76; Left / Right; Short distance lighting; 12 V / 24 V	1G4 004 480-001 Worklight	25
10.150 F, 10.150 FL	110 - 114 kW		09/87→10/93			
10.150 FK	110 - 114 kW		09/87→10/93	→ 12/91 ; Additionally required articles (article numbers): 9EL 122 689-021 / 9EL 122 689-051; P21W / R10W; Left	9BG 130 945-001 Housing, combination rearlight	26
6.100 F	75 kW		09/87→10/93			
6.100 FK	75 kW		09/87→10/93			
8.100 F	75 kW		09/87→10/93			
8.100 FK	75 kW		09/87→10/93	→ 12/91 ; Additionally required articles (article numbers): 9EL 122 689-021 / 9EL 122 689-051; P21W / R10W; Right	9BG 130 946-001 Housing, combination rearlight	26
8.150 F, 8.150 FL	92 kW		05/90→10/93			
8.150 F, 8.150 FL	110 - 114 kW		09/87→10/93			
8.150 FAE	110 - 114 kW		05/88→05/95	→ 12/91 ; P21W / R10W; Left / Right; with reverse light / with reflector / with tail light / with indicator / with stop light / with fog taillight; Number of light functions: 6; without lamp base	9EL 122 689-021 Lens, combination rearlight	31
8.150 FK	110 - 114 kW		09/87→10/93			
8.150 FOC	110 - 114 kW		07/88→10/93			
8.150 FS, 8.150 FLS	110 - 114 kW		09/87→10/93	→ 12/91 ; P21W / R10W; Left / Right; with reverse light / with reflector / with tail light / with indicator / with stop light; Number of light functions: 5; without lamp base	9EL 122 689-051 Lens, combination rearlight	32
8.170 FOC	125 - 131 kW		02/89→10/93			
9.150 F, 9.150 FL	92 kW		05/90→10/93			
9.150 F, 9.150 FL	110 - 114 kW		09/87→10/93			
9.150 FAE	110 - 114 kW		05/88→05/92			
9.150 FK	110 - 114 kW		09/87→10/93			
9.150 FOC	110 - 114 kW		07/88→10/93			
9.150 FS, 9.150 FLS	110 - 114 kW		09/87→10/93			
9.170 FOC	125 - 131 kW		02/89→10/93			
8.150 FAKO	110 kW		10/92→05/95	H3; Depth [mm]: 76; Left / Right; Short distance lighting; 12 V / 24 V	1G4 004 480-001 Worklight	25
9.150 FAKO	110 kW		10/92→05/95			
MAN - G						10/79→08/88
10.136 F, 10.136 FL	100 kW		09/81→09/87	T4W / R2 (Bilux); Left / Right; Number of light functions: 3	1A8 003 060-541 Headlight	8
10.136 FK	100 kW		09/81→09/87			

Manufacturer - Model	Power	Displ.	Year of Constr.	Remark	Part Number	Page
MAN - G						10/79→08/88
6.90 F	66 - 66 kW		10/79→09/87	T4W / H4; Left / Right; Manufacturer Restriction: Ref. 20; Number of light functions: 3	1A8 003 060-551	9
6.90 FK	66 kW		10/79→09/87		Headlight	
8.136 F,8.136 FL	100 kW		10/79→09/87	T4W / R2 (Bilux); Left / Right; for right-hand traffic; Number of light functions: 3; without carrying frame	1A8 121 149-001	Insert, 28
8.90 F	66 kW		10/79→09/87		headlight	
8.90 FK	66 kW		10/79→09/87			
9.136 F,9.136 FL	100 kW		10/79→09/87	T4W / H4; Left / Right; for right-hand traffic; Halogen; Number of light functions: 3; without carrying frame	1A8 121 150-001	Insert, 28
					headlight	
				H3; Depth [mm]: 76; Left / Right; Short distance lighting; 12 V / 24 V	1G4 004 480-001	25
					Worklight	
				T4W / R2 (Bilux); Left / Right; Number of light functions: 3	1L8 003 060-561	19
					Headlight	
				T4W / H4; Left / Right; Number of light functions: 3	1L8 003 060-691	20
					Headlight	
				Additionally required articles (article numbers): 9EL 122 689-021 / 9EL 122 689-051; P21W / R10W; Left	9BG 130 945-001	26
					Housing, combination rearlight	
				Additionally required articles (article numbers): 9EL 122 689-021 / 9EL 122 689-051; P21W / R10W; Right	9BG 130 946-001	26
					Housing, combination rearlight	
				P21W / R10W; Left / Right; with reverse light / with reflector / with tail light / with indicator / with stop light / with fog taillight; Number of light functions: 6; without lamp base	9EL 122 689-021	Lens, 31
					combination rearlight	
				P21W / R10W; Left / Right; with reverse light / with reflector / with tail light / with indicator / with stop light; Number of light functions: 5; without lamp base	9EL 122 689-051	Lens, 32
					combination rearlight	
8.136 FAE	100 kW		12/83→08/88	→08/87; T4W / R2 (Bilux); Left / Right; Number of light functions: 3	1A8 003 060-541	8
8.136 FK	100 kW		10/79→08/88		Headlight	
8.136 FOC	100 kW		03/82→07/88	→08/87; T4W / H4; Left / Right; Manufacturer Restriction: Ref. 20; Number of light functions: 3	1A8 003 060-551	9
9.136 FAE	100 kW		12/83→08/88		Headlight	
9.136 FK	100 kW		10/79→08/88	→08/87; T4W / R2 (Bilux); Left / Right; for right-hand traffic; Number of light functions: 3; without carrying frame	1A8 121 149-001	Insert, 28
9.136 FOC	100 kW		03/82→07/88		headlight	
				→08/87; T4W / H4; Left / Right; for right-hand traffic; Halogen; Number of light functions: 3; without carrying frame	1A8 121 150-001	Insert, 28
					headlight	
				H3; Depth [mm]: 76; Left / Right; Short distance lighting; 12 V / 24 V	1G4 004 480-001	25
					Worklight	
				→08/87; T4W / R2 (Bilux); Left / Right; Number of light functions: 3	1L8 003 060-561	19
					Headlight	
				→08/87; T4W / H4; Left / Right; Number of light functions: 3	1L8 003 060-691	20
					Headlight	
				Additionally required articles (article numbers): 9EL 122 689-021 / 9EL 122 689-051; P21W / R10W; Left	9BG 130 945-001	26
					Housing, combination rearlight	
				Additionally required articles (article numbers): 9EL 122 689-021 / 9EL 122 689-051; P21W / R10W; Right	9BG 130 946-001	26
					Housing, combination rearlight	
				P21W / R10W; Left / Right; with reverse light / with reflector / with tail light / with indicator / with stop light / with fog taillight; Number of light functions: 6; without lamp base	9EL 122 689-021	Lens, 31
					combination rearlight	
				P21W / R10W; Left / Right; with reverse light / with reflector / with tail light / with indicator / with stop light; Number of light functions: 5; without lamp base	9EL 122 689-051	Lens, 32
					combination rearlight	
MAN - HOCL						01/79→
10.150 HOCL	110 kW		08/87→04/04	T4W / H4; Left / Right; Number of light functions: 3; 12 V / 24 V	1AG 003 434-211	10
10.190 HOCL	132 - 137 kW		08/87→04/04		Headlight	
11.150 HOCL	110 kW		08/87→04/04			
11.190 HOCL	132 - 137 kW		08/87→04/04			
12.240 HOCL-NL	176 kW					
13.220 HOCL/R	162 - 169 kW		09/01→04/04			
14.220 HOCL/R-NL	162 kW		01/98→			
14.240 HOCL-NL	176 kW					
14.250 HOCL-NL	184 kW					
14.280 HOCL	206 kW					
14.290 HOCL-NL	213 kW					
16.240 HOC, HOCL/R	177 kW		01/79→08/96			
16.290 HOC, HOCL/R	213 kW		04/81→09/96			
16.360 HOCL/R	265 kW		01/85→09/96			
16.372 HOCL	272 kW		01/85→09/96			
18.220 HOCL/R-NL, HOCL/SKD(SL)	162 - 169 kW		08/93→05/01			
18.240 HOCL-NL	176 kW					
18.250 HOCL-NL, HOCL/SKD(SL)	184 kW		08/93→05/01			

Manufacturer - Model	Power	Displ.	Year of Constr.	Remark	Part Number	Page
MAN - HOCL						01/79→
18.290 HOCL-NL	213 kW			T4W / H4; Left / Right; Number of light functions: 3; 12 V / 24 V	1AG 003 434-211 Headlight	10
18.310 HOCL/R	228 kW		01/92→			
18.310 HOCL-NL	228 kW					
18.320 HOCL-NL	235 kW					
18.360 HOCL	265 kW					
18.400 HOCL	294 kW					
18.430 HOCL	316 kW					
18.440 HOCL	324 kW					
18.460 HOCL	338 kW					
18.480 HOCL	353 kW					
24.440 HOCLN	316 kW					
24.440 HOCLN	324 kW					
24.460 HOCLN	338 kW					
24.480 HOCLN	353 kW					
MAN - L 2000						10/93→
10.145 LC, 10.145 LLC, LRC, LLRC (LE140C)	103 kW		09/00→	T4W / H4; Left / Right; Number of light functions: 3; without bulbs; for vehicles without headlamp levelling	1EF 354 340-011 Headlight	15
10.145 LK, LRK, L-KI, LR-KI (LE140C)	103 kW		09/00→	T4W / H4; Left / Right; Number of light functions: 3; without bulbs / with motor for headlamp levelling; for vehicles with headlamp levelling (electric)	1EF 354 340-021 Headlight	16
10.145 LLS, LLRS (LE140C)	103 kW		09/00→	W5W / H7 / H7; Left; Number of light functions: 3; with bulbs; for vehicles without headlamp levelling	1EH 354 984-011 Headlight	16
10.155 LK, LRK	114 kW		02/04→			
10.163 LC, 10.163 LLC, LRC, LLRC (LE160C)	114 kW		09/00→	W5W / H7 / H7; Right; Number of light functions: 3; with bulbs; for vehicles without headlamp levelling	1EH 354 984-021 Headlight	16
10.225 LAC, LAEC, LARC, LAERC, LA-LF, LAE-LF (LE220C)	162 kW		09/00→			
10.225 LAK, LAEK, LARK, LAERK (LE220C)	162 kW		09/00→	W5W / H7 / H7; Left; Number of light functions: 3; with bulbs; for vehicles with headlamp levelling (electric)	1EH 354 984-031 Headlight	17
10.225 LC, 10.225 LLC, LRC, LLRC	162 kW		09/00→			
10.225 LC, 10.225 LLC, LRC, LLRC (LE220C)	162 kW		09/00→	W5W / H7 / H7; Right; Number of light functions: 3; with bulbs; for vehicles with headlamp levelling (electric)	1EH 354 984-041 Headlight	17
10.225 LK, LRK, L-KI, LR-KI (LE220C)	162 kW		09/00→			
10.225 LLS, LLRS (LE220C)	162 kW		09/00→	P21W / H4; Left; Yellow; with indicator / with high beam / with fog light; Number of light functions: 3; with bulbs	1NB 354 986-031 Spotlight	5, 23
8.145 LA-LF LAE-LF	103 kW		07/00→			
8.145 LC, 8.145 LLC, L-LF (LE140C)	103 kW		09/00→	P21W / H4; Left; Yellow; with indicator / with high beam / with fog light; Number of light functions: 3; with bulbs	1NB 354 986-031 Fog Light	5, 23
8.145 LLS, LLRS (LE140C)	103 kW		09/00→			
8.145 LRK, L-KI, LR-KILK (LE140C)	103 kW		09/00→	P21W / H4; Right; Yellow; with indicator / with high beam / with fog light; Number of light functions: 3; with bulbs	1NB 354 986-041 Spotlight	6, 24
8.155 L, LR, LC, LLC, LRC, LLRC, L-LF	114 kW		02/04→			
8.155 LK, LRK	114 kW		02/04→	H4 / PY21W; Left; White; with indicator / with high beam / with fog light; Number of light functions: 3; with bulbs	1NB 354 986-051 Spotlight	6, 24
8.155 LLS, LLRS	114 kW		02/04→			
8.163 LAK, LARK, LAEK, LAERK	104 kW		04/00→	H4 / PY21W; Left; White; with indicator / with high beam / with fog light; Number of light functions: 3; with bulbs	1NB 354 986-051 Fog Light	6, 24
8.163 LC, 8.163 LLC (LE160C)	114 kW		09/00→			
8.185 LAC, LAEC, LARC, LAERC, LA-LF, LAE-LF (LE180C)	132 kW		09/00→	H4 / PY21W; Right; White; with indicator / with high beam / with fog light; Number of light functions: 3; with bulbs	1NB 354 986-061 Spotlight	6, 24
8.185 LAK, LAEK, LARK, LAERK (LE180C)	132 kW		09/00→			
8.185 LC, 8.185 LLC, LRC, LLRC, L-LF (LE180C)	132 kW		09/00→	Front; White; Number of light functions: 1	2PF 354 985-021 Position Light	45
8.185 LK, LRK, L-KI, LR-KI (LE180C)	132 kW		09/00→			
8.185 LLS, LLRS (LE180C)	132 kW		09/00→	Yellow; LED; Number of light functions: 1	2PS 354 985-001 Side Marker Light	45
8.225 LAC, LAEC, LARC, LAERC (LE220C)	162 kW		09/00→			
8.225 LAK, LAEK, LARK, LAERK (LE220C)	162 kW		09/00→	T4W; Lateral Mounting; Red/Black; Number of light functions: 1; with lamp base	2XS 005 020-041 Marker Lamp	45
8.225 LC, 8.225 LLC, LRC, LLRC (LE220C)	162 kW		09/00→	T4W; Lateral Mounting; Red; without lamp base; with screws	9EL 132 215-011 Lens, marker lamp	33
8.225 LK, LRK, L-KI, LR-KI (LE220C)	162 kW		09/00→	Left; without gasket / seal	9ES 354 984-051 Diffusing Lens, headlight	4
8.225 LLS, LLRS (LE220C)	162 kW		09/00→	Right; without gasket / seal	9ES 354 984-061 Diffusing Lens, headlight	4
9.155 L, LC, LLC, LRC, LLRC	114 kW		02/04→			
9.155 LK, LRK	114 kW		02/04→			
9.155 LLS, LLRS	114 kW		02/04→			
9.185 LC, 9.185 LLC, LRC, LLRC (LE180C)	132 kW		09/00→			
9.185 LK, LRK, L-KI, LR-KI (LE180C)	132 kW		09/00→			
9.185 LLS, LLRS (LE 180C)	132 kW		09/00→			
9.225 LC, 9.225 LLC, LRC, LLRC (LE220C)	162 kW		09/00→			
9.225 LK, LRK, L-KI, LR-KI (LE220C)	162 kW		09/00→			
9.225 LLS, LLRS (LE220C)	162 kW		09/00→			

Manufacturer - Model	Power	Displ.	Year of Constr.	Remark	Part Number	Page
MAN - L 2000						10/93→
10.150 FOC	114 - 118 kW		02/95→01/96	T4W / H4; Left / Right; Number of light functions: 3; without bulbs; for vehicles without headlamp levelling	1EF 354 340-011 Headlight	15
10.153 F	114 kW		10/93→			
10.153 FA	114 kW		10/93→			
10.220 FOC,10.220 FOCL	162 kW		02/95→	T4W / H4; Left / Right; Number of light functions: 3; without bulbs / with motor for headlamp levelling; for vehicles with headlamp levelling (electric)	1EF 354 340-021 Headlight	16
10.223 F, 10.223 FL	162 kW		10/93→06/96			
10.223 FA	162 kW		10/93→06/96			
10.224 F, 10.224 FL	162 kW		05/94→			
10.224 FA	162 kW		05/94→	-08/00; P21W; Left / Right; Yellow; Number of light functions: 1; with lamp base	2BA 007 839-001 Indicator	46
10.224 LAC, LAEC, LARC, LAERC	162 kW		01/95→	P21W; Left / Lateral Mounting; Yellow; Number of light functions: 1; 12 V; with lamp base	2BM 006 692-011 Indicator	47
10.224 LAK, LAEK, LARK, LAERK	162 kW		01/95→	P21W; Right / Lateral Mounting; Yellow; Number of light functions: 1; with lamp base	2BM 006 692-021 Indicator	48
10.224 LC,10.224 LLC, LRC, LLRC	162 kW		05/94→	Front; White; Number of light functions: 1	2PF 354 985-021 Position Light	45
10.224 LK, LRK, L-KI, LR-KI	162 kW		05/94→	Yellow; LED; Number of light functions: 1	2PS 354 985-001 Side Marker Light	45
10.224 LLS, LLRS	162 kW		05/94→			
8.150 FOC,8.150 FOCL	114 - 118 kW		02/95→			
8.220 FOC,8.220 FOCL	162 kW		04/95→			
8.224 LAC, LAEC, LARC, LAERC	162 kW		01/95→	P21W / R5W; Left / Right; Number of light functions: 8; 24 V; with lamp base	2VD 008 204-051 Combination Rearlight	36
8.224 LAK, LAEK, LARK, LAERK	162 kW		01/95→			
8.224 LC,8.224 LLC, LRC, LLRC	162 kW		05/94→	P21W / R5W; Left; Number of light functions: 9; 24 V; with lamp base	2VD 008 204-071 Combination Rearlight	37
8.224 LK, LRK, L-KI, LR-KI	162 kW		05/94→			
8.224 LLS, LLRS	162 kW		05/94→	P21W / R5W; Left / Right; Number of light functions: 7; 24 V; with lamp base	2VP 008 204-041 Combination Rearlight	41
9.163 LC,9.163 LLC, LRC, LLRC	114 - 118 kW		05/94→			
9.163 LK, LRK, L-KI, LR-KI	114 - 118 kW		05/94→	P21W / R5W; Left / Right; Number of light functions: 8; 24 V; with lamp base	2VP 008 204-061 Combination Rearlight	42
9.163 LLS, LLRS	114 - 118 kW		05/94→			
9.224 LC,9.224 LLC, LRC, LLRC	162 kW		05/94→	T4W; Lateral Mounting; Red/Black; Number of light functions: 1; with lamp base	2XS 005 020-041 Marker Lamp	45
9.224 LK, LRK, L-KI, LR-KI	162 kW		05/94→			
9.224 LLS, LLRS	162 kW		05/94→	T4W; Lateral Mounting; Red; without lamp base; with screws	9EL 132 215-011 Lens, marker lamp	33
				P21W / R5W; Left / Right; Number of light functions: 5; without lamp base; with screws	9EL 152 889-001 Lens, combination rearlight	33
10.153 LAEK	114 kW		10/93→06/96	T4W / H4; Left / Right; Number of light functions: 3; without bulbs; for vehicles without headlamp levelling	1EF 354 340-011 Headlight	15
10.153 LC,10.153 LLC	114 kW		10/93→06/96			
10.153 LK	114 kW		10/93→06/96			
10.153 LLS	114 kW		10/93→06/96	T4W / H4; Left / Right; Number of light functions: 3; without bulbs / with motor for headlamp levelling; for vehicles with headlamp levelling (electric)	1EF 354 340-021 Headlight	16
10.223 LAEC	162 kW		01/95→06/96			
10.223 LC,10.223 LLC	162 - 169 kW		10/93→06/96			
10.223 LK	162 - 169 kW		10/93→06/96			
10.223 LLS	162 - 169 kW		10/93→06/96	P21W; Left / Right; Yellow; Number of light functions: 1; with lamp base	2BA 007 839-001 Indicator	46
8.103 LC, 8.103 LLC	75 kW		10/93→06/96			
8.103 LK	75 kW		10/93→06/96	P21W; Left / Lateral Mounting; Yellow; Number of light functions: 1; 12 V; with lamp base	2BM 006 692-011 Indicator	47
8.153 LAEC	114 kW		01/95→06/96			
8.153 LAEK	114 kW		01/95→09/96	P21W; Right / Lateral Mounting; Yellow; Number of light functions: 1; with lamp base	2BM 006 692-021 Indicator	48
8.153 LC,8.153 LLC	114 kW		10/93→07/97			
8.153 LK	114 kW		10/93→07/97	Front; White; Number of light functions: 1	2PF 354 985-021 Position Light	45
8.153 LLS	114 kW		10/93→06/96			
8.163 LAEC	104 kW		08/95→03/97			
8.223 LAEC	162 kW		01/95→06/96	Yellow; LED; Number of light functions: 1	2PS 354 985-001 Side Marker Light	45
8.223 LC,8.223 LLC	162 - 169 kW		10/93→06/96			
8.223 LK	162 - 169 kW		10/93→06/96	P21W / R5W; Left / Right; Number of light functions: 8; 24 V; with lamp base	2VD 008 204-051 Combination Rearlight	36
8.223 LLS	162 - 169 kW		10/93→06/96			
9.153 LC,9.153 LLC	114 kW		10/93→06/96	P21W / R5W; Left; Number of light functions: 9; 24 V; with lamp base	2VD 008 204-071 Combination Rearlight	37
9.153 LK	114 kW		10/93→06/96			
9.153 LLS	114 kW		10/93→12/95	P21W / R5W; Left / Right; Number of light functions: 7; 24 V; with lamp base	2VP 008 204-041 Combination Rearlight	41
9.163 LC	104 kW		08/95→03/97			
9.163 LK	104 kW		08/95→03/97	P21W / R5W; Left / Right; Number of light functions: 8; 24 V; with lamp base	2VP 008 204-061 Combination Rearlight	42
9.223 LC,9.223 LLC	162 - 169 kW		10/93→06/96			
9.223 LK	162 - 169 kW		10/93→06/96	T4W; Lateral Mounting; Red/Black; Number of light functions: 1; with lamp base	2XS 005 020-041 Marker Lamp	45
9.223 LLS	162 - 169 kW		10/93→06/96	T4W; Lateral Mounting; Red; without lamp base; with screws	9EL 132 215-011 Lens, marker lamp	33
				P21W / R5W; Left / Right; Number of light functions: 5; without lamp base; with screws	9EL 152 889-001 Lens, combination rearlight	33
10.163 F	114 kW		05/94→	T4W / H4; Left / Right; Number of light functions: 3; without bulbs; for vehicles without headlamp levelling	1EF 354 340-011 Headlight	15
10.163 FA	114 kW		05/94→			
10.163 LAC, LAEC, LARC, LAERC	114 - 118 kW		05/94→			
10.163 LAK, LAEK, LARK, LAERK	114 - 118 kW		01/95→	T4W / H4; Left / Right; Number of light functions: 3; without bulbs / with motor for headlamp levelling; for vehicles with headlamp levelling (electric)	1EF 354 340-021 Headlight	16
10.163 LK, LRK, L-KI, LR-KI	114 - 118 kW		05/94→			
10.163 LLS, LLRS	114 - 118 kW		05/94→	09/00→ ; W5W / H7 / H7; Left; Number of light functions: 3; with bulbs; for vehicles without headlamp levelling	1EH 354 984-011 Headlight	16
12.185 LC, LLC (LE180C)	132 kW		09/99→			
12.225 LC, LLC (LE220C)	162 kW		09/99→	09/00→ ; W5W / H7 / H7; Right; Number of light functions: 3; with bulbs; for vehicles without headlamp levelling	1EH 354 984-021 Headlight	16
8.163 LAC, LAEC, LARC, LAERC, LA-LF, LAE-LF	114 - 118 kW		01/95→			
8.163 LC,8.163 LLC	114 - 118 kW		05/94→	09/00→ ; W5W / H7 / H7; Left; Number of light functions: 3; with bulbs; for vehicles with headlamp levelling (electric)	1EH 354 984-031 Headlight	17
8.163 LC,8.163 LLC, LRC, LLRC, L-LF	104 kW		08/95→			

Manufacturer - Model	Power	Displ.	Year of Constr.	Remark	Part Number	Page
MAN - L 2000						10/93→
8.163 LK, LRK, L-KI, LR-KI	114 - 118 kW		05/94→	09/00→; W5W / H7 / H7; Right; Number of light functions: 3; with bulbs; for vehicles with headlamp levelling (electric)	1EH 354 984-041 Headlight	17
8.163 LLS, LLRS	114 - 118 kW		05/94→	09/00→; P21W / H4; Left; Yellow; with indicator / with high beam / with fog light; Number of light functions: 3; with bulbs	1NB 354 986-031 Spotlight	5, 23
				09/00→; P21W / H4; Left; Yellow; with indicator / with high beam / with fog light; Number of light functions: 3; with bulbs	1NB 354 986-031 Fog Light	5, 23
				09/00→; P21W / H4; Right; Yellow; with indicator / with high beam / with fog light; Number of light functions: 3; with bulbs	1NB 354 986-041 Spotlight	6, 24
				09/00→; P21W / H4; Right; Yellow; with indicator / with high beam / with fog light; Number of light functions: 3; with bulbs	1NB 354 986-041 Fog Light	6, 24
				09/00→; H4 / PY21W; Left; White; with indicator / with high beam / with fog light; Number of light functions: 3; with bulbs	1NB 354 986-051 Spotlight	6, 24
				09/00→; H4 / PY21W; Left; White; with indicator / with high beam / with fog light; Number of light functions: 3; with bulbs	1NB 354 986-051 Fog Light	6, 24
				09/00→; H4 / PY21W; Right; White; with indicator / with high beam / with fog light; Number of light functions: 3; with bulbs	1NB 354 986-061 Spotlight	6, 24
				09/00→; H4 / PY21W; Right; White; with indicator / with high beam / with fog light; Number of light functions: 3; with bulbs	1NB 354 986-061 Fog Light	6, 24
				-08/00; P21W; Left / Right; Yellow; Number of light functions: 1; with lamp base	2BA 007 839-001 Indicator	46
				P21W; Left / Lateral Mounting; Yellow; Number of light functions: 1; 12 V; with lamp base	2BM 006 692-011 Indicator	47
				P21W; Right / Lateral Mounting; Yellow; Number of light functions: 1; with lamp base	2BM 006 692-021 Indicator	48
				Front; White; Number of light functions: 1	2PF 354 985-021 Position Light	45
				Yellow; LED; Number of light functions: 1	2PS 354 985-001 Side Marker Light	45
				P21W / R5W; Left / Right; Number of light functions: 8; 24 V; with lamp base	2VD 008 204-051 Combination Rearlight	36
				P21W / R5W; Left; Number of light functions: 9; 24 V; with lamp base	2VD 008 204-071 Combination Rearlight	37
				P21W / R5W; Left / Right; Number of light functions: 7; 24 V; with lamp base	2VP 008 204-041 Combination Rearlight	41
				P21W / R5W; Left / Right; Number of light functions: 8; 24 V; with lamp base	2VP 008 204-061 Combination Rearlight	42
				T4W; Lateral Mounting; Red/Black; Number of light functions: 1; with lamp base	2XS 005 020-041 Marker Lamp	45
				T4W; Lateral Mounting; Red; without lamp base; with screws	9EL 132 215-011 Lens, marker lamp	33
				P21W / R5W; Left / Right; Number of light functions: 5; without lamp base; with screws	9EL 152 889-001 Lens, combination rearlight	33
				09/00→; Left; without gasket / seal	9ES 354 984-051 Diffusing Lens, headlight	4
				09/00→; Right; without gasket / seal	9ES 354 984-061 Diffusing Lens, headlight	4
10.163 LC, 10.163 LLC	114 - 118 kW		05/94→	T4W / H4; Left / Right; Number of light functions: 3; without bulbs; for vehicles without headlamp levelling	1EF 354 340-011 Headlight	15
				T4W / H4; Left / Right; Number of light functions: 3; without bulbs / with motor for headlamp levelling; for vehicles with headlamp levelling (electric)	1EF 354 340-021 Headlight	16
				09/00→; W5W / H7 / H7; Left; Number of light functions: 3; with bulbs; for vehicles without headlamp levelling	1EH 354 984-011 Headlight	16
				09/00→; W5W / H7 / H7; Right; Number of light functions: 3; with bulbs; for vehicles without headlamp levelling	1EH 354 984-021 Headlight	16
				09/00→; W5W / H7 / H7; Left; Number of light functions: 3; with bulbs; for vehicles with headlamp levelling (electric)	1EH 354 984-031 Headlight	17
				09/00→; W5W / H7 / H7; Right; Number of light functions: 3; with bulbs; for vehicles with headlamp levelling (electric)	1EH 354 984-041 Headlight	17
				09/00→; P21W / H4; Left; Yellow; with indicator / with high beam / with fog light; Number of light functions: 3; with bulbs	1NB 354 986-031 Spotlight	5, 23
				P21W / H4; Left; Yellow; with indicator / with high beam / with fog light; Number of light functions: 3; with bulbs	1NB 354 986-031 Spotlight	5, 23

Manufacturer - Model	Power	Displ.	Year of Constr.	Remark	Part Number	Page									
MAN - L 2000						10/93→									
10.163 LC,10.163 LLC	114 - 118 kW		05/94→	09/00→; P21W / H4; Left; Yellow; with indicator / with high beam / with fog light; Number of light functions: 3; with bulbs	1NB 354 986-031 Fog Light	5, 23									
				P21W / H4; Left; Yellow; with indicator / with high beam / with fog light; Number of light functions: 3; with bulbs	1NB 354 986-031 Fog Light	5, 23									
				09/00→; P21W / H4; Right; Yellow; with indicator / with high beam / with fog light; Number of light functions: 3; with bulbs	1NB 354 986-041 Spotlight	6, 24									
				P21W / H4; Right; Yellow; with indicator / with high beam / with fog light; Number of light functions: 3; with bulbs	1NB 354 986-041 Spotlight	6, 24									
				P21W / H4; Right; Yellow; with indicator / with high beam / with fog light; Number of light functions: 3; with bulbs	1NB 354 986-041 Fog Light	6, 24									
				09/00→; P21W / H4; Right; Yellow; with indicator / with high beam / with fog light; Number of light functions: 3; with bulbs	1NB 354 986-041 Fog Light	6, 24									
				H4 / PY21W; Left; White; with indicator / with high beam / with fog light; Number of light functions: 3; with bulbs	1NB 354 986-051 Spotlight	6, 24									
				09/00→; H4 / PY21W; Left; White; with indicator / with high beam / with fog light; Number of light functions: 3; with bulbs	1NB 354 986-051 Spotlight	6, 24									
				H4 / PY21W; Left; White; with indicator / with high beam / with fog light; Number of light functions: 3; with bulbs	1NB 354 986-051 Fog Light	6, 24									
				09/00→; H4 / PY21W; Left; White; with indicator / with high beam / with fog light; Number of light functions: 3; with bulbs	1NB 354 986-051 Fog Light	6, 24									
				H4 / PY21W; Right; White; with indicator / with high beam / with fog light; Number of light functions: 3; with bulbs	1NB 354 986-061 Spotlight	6, 24									
				09/00→; H4 / PY21W; Right; White; with indicator / with high beam / with fog light; Number of light functions: 3; with bulbs	1NB 354 986-061 Spotlight	6, 24									
				09/00→; H4 / PY21W; Right; White; with indicator / with high beam / with fog light; Number of light functions: 3; with bulbs	1NB 354 986-061 Fog Light	6, 24									
				H4 / PY21W; Right; White; with indicator / with high beam / with fog light; Number of light functions: 3; with bulbs	1NB 354 986-061 Fog Light	6, 24									
				-08/00; P21W; Left / Right; Yellow; Number of light functions: 1; with lamp base	2BA 007 839-001 Indicator	46									
				P21W; Left / Lateral Mounting; Yellow; Number of light functions: 1; 12 V; with lamp base	2BM 006 692-011 Indicator	47									
				P21W; Right / Lateral Mounting; Yellow; Number of light functions: 1; with lamp base	2BM 006 692-021 Indicator	48									
				Front; White; Number of light functions: 1	2PF 354 985-021 Position Light	45									
				Yellow; LED; Number of light functions: 1	2PS 354 985-001 Side Marker Light	45									
				P21W / R5W; Left / Right; Number of light functions: 8; 24 V; with lamp base	2VD 008 204-051 Combination Rearlight	36									
				P21W / R5W; Left; Number of light functions: 9; 24 V; with lamp base	2VD 008 204-071 Combination Rearlight	37									
				P21W / R5W; Left / Right; Number of light functions: 7; 24 V; with lamp base	2VP 008 204-041 Combination Rearlight	41									
				P21W / R5W; Left / Right; Number of light functions: 8; 24 V; with lamp base	2VP 008 204-061 Combination Rearlight	42									
				T4W; Lateral Mounting; Red/Black; Number of light functions: 1; with lamp base	2XS 005 020-041 Marker Lamp	45									
				T4W; Lateral Mounting; Red; without lamp base; with screws	9EL 132 215-011 Lens, marker lamp	33									
				P21W / R5W; Left / Right; Number of light functions: 5; without lamp base; with screws	9EL 152 889-001 Lens, combination rearlight	33									
				09/00→; Left; without gasket / seal	9ES 354 984-051 Diffusing Lens, headlight	4									
				09/00→; Right; without gasket / seal	9ES 354 984-061 Diffusing Lens, headlight	4									
				10.185 LAC, LAEC, LARC, LAERC, LA-LA, LAE-LF (LE180C)	132 kW		09/00→	T4W / H4; Left / Right; Number of light functions: 3; without bulbs; for vehicles without headlamp levelling	1EF 354 340-011 Headlight	15					
								10.185 LAK, LAEK, LARK, LAERK (LE180C)	132 kW	09/00→	T4W / H4; Left / Right; Number of light functions: 3; without bulbs / with motor for headlamp levelling; for vehicles with headlamp levelling (electric)	1EF 354 340-021 Headlight	16		
10.185 LC,10.185 LLC, LRC, LLRC (LE180C)	132 kW	09/00→	W5W / H7 / H7; Left; Number of light functions: 3; with bulbs; for vehicles without headlamp levelling								1EH 354 984-011 Headlight	16			
			10.185 LK, LRK, L-KI, LR-KI (LE180C)								132 kW	09/00→			
													10.185 LLS, LLRS (LE180C)	132 kW	09/00→

Manufacturer - Model	Power	Displ.	Year of Constr.	Remark	Part Number	Page
MAN - L 2000						10/93→
10.185 LAC, LAEC, LARC, LAERC, LA-LA, LAE-LF (LE180C)	132 kW		09/00→	W5W / H7 / H7; Right; Number of light functions: 3; with bulbs; for vehicles without headlamp levelling	1EH 354 984-021 Headlight	16
10.185 LAK, LAEK, LARK, LAERK (LE180C)	132 kW		09/00→	W5W / H7 / H7; Left; Number of light functions: 3; with bulbs; for vehicles with headlamp levelling (electric)	1EH 354 984-031 Headlight	17
10.185 LC, 10.185 LLC, LRC, LLRC (LE180C)	132 kW		09/00→	W5W / H7 / H7; Right; Number of light functions: 3; with bulbs; for vehicles with headlamp levelling (electric)	1EH 354 984-041 Headlight	17
10.185 LK, LRK, L-KI, LR-KI (LE180C)	132 kW		09/00→	Front; White; Number of light functions: 1	2PF 354 985-021 Position Light	45
10.185 LLS, LLRS (LE180C)	132 kW		09/00→	Yellow; LED; Number of light functions: 1	2PS 354 985-001 Side Marker Light	45
				T4W; Lateral Mounting; Red/Black; Number of light functions: 1; with lamp base	2XS 005 020-041 Marker Lamp	45
				T4W; Lateral Mounting; Red; without lamp base; with screws	9EL 132 215-011 Lens, marker lamp	33
				Left; without gasket / seal	9ES 354 984-051 Diffusing Lens, headlight	4
				Right; without gasket / seal	9ES 354 984-061 Diffusing Lens, headlight	4
8.113 LC, 8.113 LLC	81 kW		08/95→	T4W / H4; Left / Right; Number of light functions: 3; without bulbs; for vehicles without headlamp levelling	1EF 354 340-011 Headlight	15
				T4W / H4; Left / Right; Number of light functions: 3; without bulbs / with motor for headlamp levelling; for vehicles with headlamp levelling (electric)	1EF 354 340-021 Headlight	16
				P21W / H4; Left; Yellow; with indicator / with high beam / with fog light; Number of light functions: 3; with bulbs	1NB 354 986-031 Spotlight	5, 23
				P21W / H4; Left; Yellow; with indicator / with high beam / with fog light; Number of light functions: 3; with bulbs	1NB 354 986-031 Fog Light	5, 23
				P21W / H4; Right; Yellow; with indicator / with high beam / with fog light; Number of light functions: 3; with bulbs	1NB 354 986-041 Spotlight	6, 24
				P21W / H4; Right; Yellow; with indicator / with high beam / with fog light; Number of light functions: 3; with bulbs	1NB 354 986-041 Fog Light	6, 24
				H4 / PY21W; Left; White; with indicator / with high beam / with fog light; Number of light functions: 3; with bulbs	1NB 354 986-051 Spotlight	6, 24
				H4 / PY21W; Left; White; with indicator / with high beam / with fog light; Number of light functions: 3; with bulbs	1NB 354 986-051 Fog Light	6, 24
				H4 / PY21W; Right; White; with indicator / with high beam / with fog light; Number of light functions: 3; with bulbs	1NB 354 986-061 Spotlight	6, 24
				H4 / PY21W; Right; White; with indicator / with high beam / with fog light; Number of light functions: 3; with bulbs	1NB 354 986-061 Fog Light	6, 24
				-08/00; P21W; Left / Right; Yellow; Number of light functions: 1; with lamp base	2BA 007 839-001 Indicator	46
				P21W; Left / Lateral Mounting; Yellow; Number of light functions: 1; 12 V; with lamp base	2BM 006 692-011 Indicator	47
				P21W; Right / Lateral Mounting; Yellow; Number of light functions: 1; with lamp base	2BM 006 692-021 Indicator	48
				Front; White; Number of light functions: 1	2PF 354 985-021 Position Light	45
				Yellow; LED; Number of light functions: 1	2PS 354 985-001 Side Marker Light	45
				P21W / R5W; Left / Right; Number of light functions: 8; 24 V; with lamp base	2VD 008 204-051 Combination Rearlight	36
				P21W / R5W; Left; Number of light functions: 9; 24 V; with lamp base	2VD 008 204-071 Combination Rearlight	37
				P21W / R5W; Left / Right; Number of light functions: 7; 24 V; with lamp base	2VP 008 204-041 Combination Rearlight	41
				P21W / R5W; Left / Right; Number of light functions: 8; 24 V; with lamp base	2VP 008 204-061 Combination Rearlight	42
				T4W; Lateral Mounting; Red/Black; Number of light functions: 1; with lamp base	2XS 005 020-041 Marker Lamp	45
				T4W; Lateral Mounting; Red; without lamp base; with screws	9EL 132 215-011 Lens, marker lamp	33
				P21W / R5W; Left / Right; Number of light functions: 5; without lamp base; with screws	9EL 152 889-001 Lens, combination rearlight	33
8.113 LC, 8.113 LLC, LRC, LLRC, (LE110C)	83 kW		09/00→	T4W / H4; Left / Right; Number of light functions: 3; without bulbs; for vehicles without headlamp levelling	1EF 354 340-011 Headlight	15
9.145 LC, 9.145 LLC, LRC, LLRC (LE140C)	103 kW		09/00→			

Manufacturer - Model	Power	Displ.	Year of Constr.	Remark	Part Number	Page
MAN - L 2000						10/93→
9.145 LK, LRK, L-KI, LR-KI (LE140C)	103 kW		09/00→	T4W / H4; Left / Right; Number of light functions: 3; without bulbs / with motor for headlamp levelling; for vehicles with headlamp levelling (electric)	1EF 354 340-021 Headlight	16
9.145 LLS, LLRS (LE140C)	103 kW		09/00→	P21W / H4; Left; Yellow; with indicator / with high beam / with fog light; Number of light functions: 3; with bulbs	1NB 354 986-031 Spotlight	5, 23
				P21W / H4; Left; Yellow; with indicator / with high beam / with fog light; Number of light functions: 3; with bulbs	1NB 354 986-031 Fog Light	5, 23
				P21W / H4; Right; Yellow; with indicator / with high beam / with fog light; Number of light functions: 3; with bulbs	1NB 354 986-041 Spotlight	6, 24
				P21W / H4; Right; Yellow; with indicator / with high beam / with fog light; Number of light functions: 3; with bulbs	1NB 354 986-041 Fog Light	6, 24
				H4 / PY21W; Left; White; with indicator / with high beam / with fog light; Number of light functions: 3; with bulbs	1NB 354 986-051 Spotlight	6, 24
				H4 / PY21W; Left; White; with indicator / with high beam / with fog light; Number of light functions: 3; with bulbs	1NB 354 986-051 Fog Light	6, 24
				H4 / PY21W; Right; White; with indicator / with high beam / with fog light; Number of light functions: 3; with bulbs	1NB 354 986-061 Spotlight	6, 24
				H4 / PY21W; Right; White; with indicator / with high beam / with fog light; Number of light functions: 3; with bulbs	1NB 354 986-061 Fog Light	6, 24
				Front; White; Number of light functions: 1	2PF 354 985-021 Position Light	45
				Yellow; LED; Number of light functions: 1	2PS 354 985-001 Side Marker Light	45
				T4W; Lateral Mounting; Red/Black; Number of light functions: 1; with lamp base	2XS 005 020-041 Marker Lamp	45
				T4W; Lateral Mounting; Red; without lamp base; with screws	9EL 132 215-011 Lens, marker lamp	33
8.113 LK, LRK, L-KI, LR-KI	81 kW		08/95→	T4W / H4; Left / Right; Number of light functions: 3; without bulbs; for vehicles without headlamp levelling	1EF 354 340-011 Headlight	15
				T4W / H4; Left / Right; Number of light functions: 3; without bulbs / with motor for headlamp levelling; for vehicles with headlamp levelling (electric)	1EF 354 340-021 Headlight	16
				09/00→; P21W / H4; Left; Yellow; with indicator / with high beam / with fog light; Number of light functions: 3; with bulbs	1NB 354 986-031 Spotlight	5, 23
				09/00→; P21W / H4; Left; Yellow; with indicator / with high beam / with fog light; Number of light functions: 3; with bulbs	1NB 354 986-031 Fog Light	5, 23
				09/00→; P21W / H4; Right; Yellow; with indicator / with high beam / with fog light; Number of light functions: 3; with bulbs	1NB 354 986-041 Spotlight	6, 24
				09/00→; P21W / H4; Right; Yellow; with indicator / with high beam / with fog light; Number of light functions: 3; with bulbs	1NB 354 986-041 Fog Light	6, 24
				09/00→; H4 / PY21W; Left; White; with indicator / with high beam / with fog light; Number of light functions: 3; with bulbs	1NB 354 986-051 Spotlight	6, 24
				09/00→; H4 / PY21W; Left; White; with indicator / with high beam / with fog light; Number of light functions: 3; with bulbs	1NB 354 986-051 Fog Light	6, 24
				09/00→; H4 / PY21W; Right; White; with indicator / with high beam / with fog light; Number of light functions: 3; with bulbs	1NB 354 986-061 Spotlight	6, 24
				09/00→; H4 / PY21W; Right; White; with indicator / with high beam / with fog light; Number of light functions: 3; with bulbs	1NB 354 986-061 Fog Light	6, 24
				→08/00; P21W; Left / Right; Yellow; Number of light functions: 1; with lamp base	2BA 007 839-001 Indicator	46
				P21W; Left / Lateral Mounting; Yellow; Number of light functions: 1; 12 V; with lamp base	2BM 006 692-011 Indicator	47
				P21W; Right / Lateral Mounting; Yellow; Number of light functions: 1; with lamp base	2BM 006 692-021 Indicator	48
				Front; White; Number of light functions: 1	2PF 354 985-021 Position Light	45
				Yellow; LED; Number of light functions: 1	2PS 354 985-001 Side Marker Light	45
				P21W / R5W; Left / Right; Number of light functions: 8; 24 V; with lamp base	2VD 008 204-051 Combination Rearlight	36
				P21W / R5W; Left; Number of light functions: 9; 24 V; with lamp base	2VD 008 204-071 Combination Rearlight	37
				P21W / R5W; Left / Right; Number of light functions: 7; 24 V; with lamp base	2VP 008 204-041 Combination Rearlight	41

Manufacturer - Model	Power	Displ.	Year of Constr.	Remark	Part Number	Page
MAN - L 2000						10/93→
8.113 LK, LRK, L-KI, LR-KI	81 kW		08/95→	P21W / R5W; Left / Right; Number of light functions: 8; 24 V; with lamp base	2VP 008 204-061 Combination Rearlight	42
				T4W; Lateral Mounting; Red/Black; Number of light functions: 1; with lamp base	2XS 005 020-041 Marker Lamp	45
				T4W; Lateral Mounting; Red; without lamp base; with screws	9EL 132 215-011 Lens, marker lamp	33
				P21W / R5W; Left / Right; Number of light functions: 5; without lamp base; with screws	9EL 152 889-001 Lens, combination rearlight	33
MAN - LION S CITY						02/09→
A 22	206 kW		10/09→	W5W / H7 / H7; Left; Number of light functions: 3; with bulbs; for vehicles without headlamp levelling	1EH 354 984-011 Headlight	16
A 22	235 kW		10/09→			
A 22	265 kW		10/09→	W5W / H7 / H7; Right; Number of light functions: 3; with bulbs; for vehicles without headlamp levelling	1EH 354 984-021 Headlight	16
A 35	184 kW		10/09→			
A 35	213 kW		10/09→	W5W / H7 / H7; Left; Number of light functions: 3; with bulbs; for vehicles with headlamp levelling (electric)	1EH 354 984-031 Headlight	17
A 66	184 kW		02/09→			
A 66	213 kW		02/09→	W5W / H7 / H7; Right; Number of light functions: 3; with bulbs; for vehicles with headlamp levelling (electric)	1EH 354 984-041 Headlight	17
				P21W / H4; Left; Yellow; with indicator / with high beam / with fog light; Number of light functions: 3; with bulbs	1NB 354 986-031 Spotlight	5, 23
				P21W / H4; Left; Yellow; with indicator / with high beam / with fog light; Number of light functions: 3; with bulbs	1NB 354 986-031 Fog Light	5, 23
				P21W / H4; Right; Yellow; with indicator / with high beam / with fog light; Number of light functions: 3; with bulbs	1NB 354 986-041 Spotlight	6, 24
				P21W / H4; Right; Yellow; with indicator / with high beam / with fog light; Number of light functions: 3; with bulbs	1NB 354 986-041 Fog Light	6, 24
				H4 / PY21W; Left; White; with indicator / with high beam / with fog light; Number of light functions: 3; with bulbs	1NB 354 986-051 Spotlight	6, 24
				H4 / PY21W; Left; White; with indicator / with high beam / with fog light; Number of light functions: 3; with bulbs	1NB 354 986-051 Fog Light	6, 24
				H4 / PY21W; Right; White; with indicator / with high beam / with fog light; Number of light functions: 3; with bulbs	1NB 354 986-061 Spotlight	6, 24
				H4 / PY21W; Right; White; with indicator / with high beam / with fog light; Number of light functions: 3; with bulbs	1NB 354 986-061 Fog Light	6, 24
				Left; without gasket / seal	9ES 354 984-051 Diffusing Lens, headlight	4
				Right; without gasket / seal	9ES 354 984-061 Diffusing Lens, headlight	4
MAN - LION S COACH						09/95→
FRH 352,RH 353	257 kW		09/95→	W5W / H7 / H7; Left; Number of light functions: 3; with bulbs; for vehicles without headlamp levelling	1EH 354 984-011 Headlight	16
				W5W / H7 / H7; Right; Number of light functions: 3; with bulbs; for vehicles without headlamp levelling	1EH 354 984-021 Headlight	16
				W5W / H7 / H7; Left; Number of light functions: 3; with bulbs; for vehicles with headlamp levelling (electric)	1EH 354 984-031 Headlight	17
				W5W / H7 / H7; Right; Number of light functions: 3; with bulbs; for vehicles with headlamp levelling (electric)	1EH 354 984-041 Headlight	17
				P21W / H4; Left; Yellow; with indicator / with high beam / with fog light; Number of light functions: 3; with bulbs	1NB 354 986-031 Spotlight	5, 23
				P21W / H4; Left; Yellow; with indicator / with high beam / with fog light; Number of light functions: 3; with bulbs	1NB 354 986-031 Fog Light	5, 23
				P21W / H4; Right; Yellow; with indicator / with high beam / with fog light; Number of light functions: 3; with bulbs	1NB 354 986-041 Spotlight	6, 24
				P21W / H4; Right; Yellow; with indicator / with high beam / with fog light; Number of light functions: 3; with bulbs	1NB 354 986-041 Fog Light	6, 24
				H4 / PY21W; Left; White; with indicator / with high beam / with fog light; Number of light functions: 3; with bulbs	1NB 354 986-051 Spotlight	6, 24
				H4 / PY21W; Left; White; with indicator / with high beam / with fog light; Number of light functions: 3; with bulbs	1NB 354 986-051 Fog Light	6, 24
				H4 / PY21W; Right; White; with indicator / with high beam / with fog light; Number of light functions: 3; with bulbs	1NB 354 986-061 Spotlight	6, 24

Manufacturer - Model	Power	Displ.	Year of Constr.	Remark	Part Number	Page
MAN - LION S COACH						09/95→
FRH 352,RH 353	257 kW		09/95→	H4 / PY21W; Right; White; with indicator / with high beam / with fog light; Number of light functions: 3; with bulbs	1NB 354 986-061 Fog Light	6, 24
				P21W; Left / Right / Front; Yellow; Number of light functions: 1; with lamp base	2BA 005 603-001 Indicator	46
				C5W; Left / Right; Number of light functions: 1; with lamp base	2KA 001 388-051 Licence Plate Light	44
				Left; without gasket / seal	9ES 354 984-051 Diffusing Lens, headlight	4
				Right; without gasket / seal	9ES 354 984-061 Diffusing Lens, headlight	4
FRH 402,RH 403 RH 413 RH 463, RHC 464 RHC 414	294 kW 301 kW 338 kW 301 kW		09/95→ 01/00→ 01/00→ 06/02→	W5W / H7 / H7; Left; Number of light functions: 3; with bulbs; for vehicles without headlamp levelling	1EH 354 984-011 Headlight	16
				W5W / H7 / H7; Right; Number of light functions: 3; with bulbs; for vehicles without headlamp levelling	1EH 354 984-021 Headlight	16
				W5W / H7 / H7; Left; Number of light functions: 3; with bulbs; for vehicles with headlamp levelling (electric)	1EH 354 984-031 Headlight	17
				W5W / H7 / H7; Right; Number of light functions: 3; with bulbs; for vehicles with headlamp levelling (electric)	1EH 354 984-041 Headlight	17
				P21W / H4; Left; Yellow; with indicator / with high beam / with fog light; Number of light functions: 3; with bulbs	1NB 354 986-031 Spotlight	5, 23
				P21W / H4; Left; Yellow; with indicator / with high beam / with fog light; Number of light functions: 3; with bulbs	1NB 354 986-031 Fog Light	5, 23
				P21W / H4; Right; Yellow; with indicator / with high beam / with fog light; Number of light functions: 3; with bulbs	1NB 354 986-041 Spotlight	6, 24
				P21W / H4; Right; Yellow; with indicator / with high beam / with fog light; Number of light functions: 3; with bulbs	1NB 354 986-041 Fog Light	6, 24
				H4 / PY21W; Left; White; with indicator / with high beam / with fog light; Number of light functions: 3; with bulbs	1NB 354 986-051 Spotlight	6, 24
				H4 / PY21W; Left; White; with indicator / with high beam / with fog light; Number of light functions: 3; with bulbs	1NB 354 986-051 Fog Light	6, 24
				H4 / PY21W; Right; White; with indicator / with high beam / with fog light; Number of light functions: 3; with bulbs	1NB 354 986-061 Spotlight	6, 24
				H4 / PY21W; Right; White; with indicator / with high beam / with fog light; Number of light functions: 3; with bulbs	1NB 354 986-061 Fog Light	6, 24
				Left; without gasket / seal	9ES 354 984-051 Diffusing Lens, headlight	4
				Right; without gasket / seal	9ES 354 984-061 Diffusing Lens, headlight	4
				RH 402	294 kW	
P21W / H4; Left; Yellow; with indicator / with high beam / with fog light; Number of light functions: 3; with bulbs	1NB 354 986-031 Fog Light	5, 23				
P21W / H4; Right; Yellow; with indicator / with high beam / with fog light; Number of light functions: 3; with bulbs	1NB 354 986-041 Spotlight	6, 24				
P21W / H4; Right; Yellow; with indicator / with high beam / with fog light; Number of light functions: 3; with bulbs	1NB 354 986-041 Fog Light	6, 24				
H4 / PY21W; Left; White; with indicator / with high beam / with fog light; Number of light functions: 3; with bulbs	1NB 354 986-051 Spotlight	6, 24				
H4 / PY21W; Left; White; with indicator / with high beam / with fog light; Number of light functions: 3; with bulbs	1NB 354 986-051 Fog Light	6, 24				
H4 / PY21W; Right; White; with indicator / with high beam / with fog light; Number of light functions: 3; with bulbs	1NB 354 986-061 Spotlight	6, 24				
H4 / PY21W; Right; White; with indicator / with high beam / with fog light; Number of light functions: 3; with bulbs	1NB 354 986-061 Fog Light	6, 24				
MAN - LION S COMFORT						09/96→
RN 313 RN 353	228 kW 257 kW		09/96→ 06/97→	H1 / T4W; Left; Number of light functions: 2; 12 V / 24 V	1BL 005 740-091 Insert, headlight	29
				H1 / T4W; Right; Number of light functions: 2; 12 V / 24 V	1BL 005 740-101 Insert, headlight	30
				W5W / H7 / H7; Left; Number of light functions: 3; with bulbs; for vehicles without headlamp levelling	1EH 354 984-011 Headlight	16

Manufacturer - Model	Power	Displ.	Year of Constr.	Remark	Part Number	Page
MAN - LION S COMFORT						09/96→
RN 313	228 kW		09/96→	W5W / H7 / H7; Right; Number of light functions: 3; with bulbs; for vehicles without headlamp levelling	1EH 354 984-021 Headlight	16
RN 353	257 kW		06/97→	W5W / H7 / H7; Left; Number of light functions: 3; with bulbs; for vehicles with headlamp levelling (electric)	1EH 354 984-031 Headlight	17
				W5W / H7 / H7; Right; Number of light functions: 3; with bulbs; for vehicles with headlamp levelling (electric)	1EH 354 984-041 Headlight	17
				H1; Depth [mm]: 140; Three-point mounting; Fitting Depth [mm]: 133; Left; Inner Diameter [mm]: 120; Manufacturer Restriction: Ref. 27,5; Number of light functions: 1; 12 V / 24 V	1FE 005 478-011 Spotlight	22
				H1; Depth [mm]: 140; Three-point mounting; Fitting Depth [mm]: 133; Right; Inner Diameter [mm]: 120; for main beam / with high beam; Manufacturer Restriction: Ref. 27,5; Number of light functions: 1; 12 V / 24 V	1FE 005 478-021 Spotlight	23
				P21W / H4; Left; Yellow; with indicator / with high beam / with fog light; Number of light functions: 3; with bulbs	1NB 354 986-031 Spotlight	5, 23
				P21W / H4; Left; Yellow; with indicator / with high beam / with fog light; Number of light functions: 3; with bulbs	1NB 354 986-031 Fog Light	5, 23
				P21W / H4; Right; Yellow; with indicator / with high beam / with fog light; Number of light functions: 3; with bulbs	1NB 354 986-041 Spotlight	6, 24
				P21W / H4; Right; Yellow; with indicator / with high beam / with fog light; Number of light functions: 3; with bulbs	1NB 354 986-041 Fog Light	6, 24
				H4 / PY21W; Left; White; with indicator / with high beam / with fog light; Number of light functions: 3; with bulbs	1NB 354 986-051 Spotlight	6, 24
				H4 / PY21W; Left; White; with indicator / with high beam / with fog light; Number of light functions: 3; with bulbs	1NB 354 986-051 Fog Light	6, 24
				H4 / PY21W; Right; White; with indicator / with high beam / with fog light; Number of light functions: 3; with bulbs	1NB 354 986-061 Spotlight	6, 24
				H4 / PY21W; Right; White; with indicator / with high beam / with fog light; Number of light functions: 3; with bulbs	1NB 354 986-061 Fog Light	6, 24
				P21W; Left / Right / Front; Yellow; Number of light functions: 1; with lamp base	2BA 005 603-001 Indicator	46
				C5W; Left / Right; Number of light functions: 1; with lamp base	2KA 001 388-051 Licence Plate Light	44
				Left; without gasket / seal	9ES 354 984-051 Diffusing Lens, headlight	4
				Right; without gasket / seal	9ES 354 984-061 Diffusing Lens, headlight	4
MAN - LION S STAR						01/93→
FRH 352,RH 353	257 kW		09/95→	Left; without gasket / seal	9ES 354 984-051 Diffusing Lens, headlight	4
				Right; without gasket / seal	9ES 354 984-061 Diffusing Lens, headlight	4
FRH 402,RH 403	294 kW		09/95→	W5W / H7 / H7; Left; Number of light functions: 3; with bulbs; for vehicles without headlamp levelling	1EH 354 984-011 Headlight	16
RH 464, RHS 464	301 kW		03/00→	W5W / H7 / H7; Right; Number of light functions: 3; with bulbs; for vehicles without headlamp levelling	1EH 354 984-021 Headlight	16
RH 464, RHS 464	301 kW		01/02→	W5W / H7 / H7; Left; Number of light functions: 3; with bulbs; for vehicles with headlamp levelling (electric)	1EH 354 984-031 Headlight	17
RH 414	338 kW		03/00→	W5W / H7 / H7; Right; Number of light functions: 3; with bulbs; for vehicles with headlamp levelling (electric)	1EH 354 984-041 Headlight	17
RH 464, RHS 464	338 kW		01/02→	P21W / H4; Left; Yellow; with indicator / with high beam / with fog light; Number of light functions: 3; with bulbs	1NB 354 986-031 Spotlight	5, 23
				P21W / H4; Left; Yellow; with indicator / with high beam / with fog light; Number of light functions: 3; with bulbs	1NB 354 986-031 Fog Light	5, 23
				P21W / H4; Right; Yellow; with indicator / with high beam / with fog light; Number of light functions: 3; with bulbs	1NB 354 986-041 Spotlight	6, 24
				P21W / H4; Right; Yellow; with indicator / with high beam / with fog light; Number of light functions: 3; with bulbs	1NB 354 986-041 Fog Light	6, 24
				H4 / PY21W; Left; White; with indicator / with high beam / with fog light; Number of light functions: 3; with bulbs	1NB 354 986-051 Spotlight	6, 24

Manufacturer - Model	Power	Displ.	Year of Constr.	Remark	Part Number	Page
MAN - LION S STAR						01/93→
FRH 402,RH 403	294 kW		09/95→	H4 / PY21W; Left; White; with indicator / with high beam / with fog light; Number of light functions: 3; with bulbs	1NB 354 986-051 Fog Light	6, 24
RH 464, RHS 464	301 kW		03/00→			
RH 464, RHS 464	301 kW		01/02→			
RH 414	338 kW		03/00→	H4 / PY21W; Right; White; with indicator / with high beam / with fog light; Number of light functions: 3; with bulbs	1NB 354 986-061 Spotlight	6, 24
RH 464, RHS 464	338 kW		01/02→			
				H4 / PY21W; Right; White; with indicator / with high beam / with fog light; Number of light functions: 3; with bulbs	1NB 354 986-061 Fog Light	6, 24
				Left; without gasket / seal	9ES 354 984-051 Diffusing Lens, headlight	4
				Right; without gasket / seal	9ES 354 984-061 Diffusing Lens, headlight	4
FRH 422	309 kW		01/93→09/96	H1 / T4W; Left; Number of light functions: 2; 12 V / 24 V	1BL 005 740-091 Insert, headlight	29
				H1 / T4W; Right; Number of light functions: 2; 12 V / 24 V	1BL 005 740-101 Insert, headlight	30
				W5W / H7 / H7; Left; Number of light functions: 3; with bulbs; for vehicles without headlamp levelling	1EH 354 984-011 Headlight	16
				W5W / H7 / H7; Right; Number of light functions: 3; with bulbs; for vehicles without headlamp levelling	1EH 354 984-021 Headlight	16
				W5W / H7 / H7; Left; Number of light functions: 3; with bulbs; for vehicles with headlamp levelling (electric)	1EH 354 984-031 Headlight	17
				W5W / H7 / H7; Right; Number of light functions: 3; with bulbs; for vehicles with headlamp levelling (electric)	1EH 354 984-041 Headlight	17
				H1; Depth [mm]: 140; Three-point mounting; Fitting Depth [mm]: 133; Left; Inner Diameter [mm]: 120; Manufacturer Restriction: Ref. 27,5; Number of light functions: 1; 12 V / 24 V	1FE 005 478-011 Spotlight	22
				H1; Depth [mm]: 140; Three-point mounting; Fitting Depth [mm]: 133; Right; Inner Diameter [mm]: 120; for main beam / with high beam; Manufacturer Restriction: Ref. 27,5; Number of light functions: 1; 12 V / 24 V	1FE 005 478-021 Spotlight	23
				P21W / H4; Left; Yellow; with indicator / with high beam / with fog light; Number of light functions: 3; with bulbs	1NB 354 986-031 Spotlight	5, 23
				P21W / H4; Left; Yellow; with indicator / with high beam / with fog light; Number of light functions: 3; with bulbs	1NB 354 986-031 Fog Light	5, 23
				P21W / H4; Right; Yellow; with indicator / with high beam / with fog light; Number of light functions: 3; with bulbs	1NB 354 986-041 Spotlight	6, 24
				P21W / H4; Right; Yellow; with indicator / with high beam / with fog light; Number of light functions: 3; with bulbs	1NB 354 986-041 Fog Light	6, 24
				H4 / PY21W; Left; White; with indicator / with high beam / with fog light; Number of light functions: 3; with bulbs	1NB 354 986-051 Spotlight	6, 24
				H4 / PY21W; Left; White; with indicator / with high beam / with fog light; Number of light functions: 3; with bulbs	1NB 354 986-051 Fog Light	6, 24
				H4 / PY21W; Right; White; with indicator / with high beam / with fog light; Number of light functions: 3; with bulbs	1NB 354 986-061 Spotlight	6, 24
				H4 / PY21W; Right; White; with indicator / with high beam / with fog light; Number of light functions: 3; with bulbs	1NB 354 986-061 Fog Light	6, 24
				P21W; Left / Right / Front; Yellow; Number of light functions: 1; with lamp base	2BA 005 603-001 Indicator	46
				C5W; Left / Right; Number of light functions: 1; with lamp base	2KA 001 388-051 Licence Plate Light	44
				Left; without gasket / seal	9ES 354 984-051 Diffusing Lens, headlight	4
				Right; without gasket / seal	9ES 354 984-061 Diffusing Lens, headlight	4
MAN - M 90						08/88→06/96
12.152 F,12.152 FL	110 - 114 kW		12/88→05/94	T4W / H4; Left / Right; Number of light functions: 3; 12 V / 24 V	1AG 003 434-211 Headlight	10
12.152 FK	110 - 114 kW		12/88→05/94			
12.152 FS,12.152 FLS	110 - 114 kW		12/88→05/94	T4W / H4; Left / Right; Number of light functions: 3; without bulbs; for vehicles without headlamp levelling	1EF 354 340-011 Headlight	15
12.192 F,12.192 FL	140 kW		07/90→06/96			
12.192 FK	140 kW		07/90→06/96			
12.192 FS,12.192 FLS	140 kW		07/90→06/96	T4W / H4; Left / Right; Number of light functions: 3; without bulbs / with motor for headlamp levelling; for vehicles with headlamp levelling (electric)	1EF 354 340-021 Headlight	16
12.232 F,12.232 FL	169 kW		08/88→06/96			
12.232 FA	169 kW		05/90→06/96			
12.232 FAK	169 kW		05/90→06/96			
12.232 FK	169 kW		08/88→06/96	H3; Depth [mm]: 76; Left / Right; Short distance lighting; 12 V / 24 V	1G4 004 480-001 Worklight	25
12.232 FS,12.232 FLS	169 kW		08/88→06/96			

Manufacturer - Model	Power	Displ.	Year of Constr.	Remark	Part Number	Page
MAN - M 90			08/88→06/96			
14.152 F,14.152 FL	110 - 114 kW		12/88→04/94	10/90→; →04/93; H3; Fitting Depth [mm]: 89; Left / Right; Transparent; Number of light functions: 1; + H 166 mm; 12 V / 24 V	1NE 006 300-051 Fog Light	7
14.152 FK	110 - 114 kW		12/88→05/94			
14.152 FS,14.152 FLS	110 - 114 kW		12/88→05/94			
14.192 F,14.192 FL	140 kW		07/90→06/96	P21W; Left / Right; Yellow; Number of light functions: 1; with lamp base	2BA 007 840-001 Indicator	47
14.192 FK	140 kW		07/90→06/96			
14.192 FS,14.192 FLS	140 kW		07/90→06/96			
14.232 F,14.232 FL	160 kW		05/90→04/95	→ 12/91; P21W; Left / Right; Number of light functions: 1; with lamp base	2KA 003 389-081 Licence Plate Light	44
14.232 F,14.232 FL	169 kW		08/88→06/96			
14.232 FK	169 kW		08/88→06/96	T4W; Lateral Mounting; Red/Black; Number of light functions: 1; with lamp base	2XS 005 020-041 Marker Lamp	45
14.232 FS,14.232 FLS	160 kW		05/90→04/95			
14.232 FS,14.232 FLS	169 kW		08/88→06/96	→ 12/91; R10W; without lamp base; with screw	9BG 121 587-031 Housing, licence plate light	27
17.192 F,17.192 FL	140 kW		07/90→04/95			
17.192 FA	140 kW		07/90→06/96			
17.192 FAK	140 kW		07/90→06/96	→ 12/91; Additionally required articles (article numbers): 9EL 122 689-021 / 9EL 122 689-051; P21W / R10W; Left	9BG 130 945-001 Housing, combination rearlight	26
17.192 FS,17.192 FLS	140 kW		07/90→04/95			
17.232 F,17.232 FL	160 kW		05/90→04/95			
17.232 F,17.232 FL	169 kW		08/88→04/95			
17.232 FA	160 kW		05/90→04/95			
17.232 FA	169 kW		02/89→06/96			
17.232 FAK	160 kW		05/90→04/95			
17.232 FAK	169 kW		02/89→06/96	→ 12/91; P21W / R10W; Left / Right; with reverse light / with reflector / with tail light / with indicator / with stop light / with fog taillight; Number of light functions: 6; without lamp base	9EL 122 689-021 Lens, combination rearlight	31
17.232 FS,17.232 FLS	160 kW		05/90→04/95			
17.232 FS,17.232 FLS	169 kW		08/88→04/95			
24.192 FNL,24.192 FNLL,24.192 FVL	140 kW		07/89→06/96	→ 12/91; P21W / R10W; Left / Right; with reverse light / with reflector / with tail light / with indicator / with stop light; Number of light functions: 5; without lamp base	9EL 122 689-051 Lens, combination rearlight	32
24.232 FNL	160 kW		05/90→04/95			
24.232 FNL,24.232 FNLL,24.232 FVL	169 kW		07/89→06/96	T4W; Lateral Mounting; Red; without lamp base; with screws	9EL 132 215-011 Lens, marker lamp	33
				H4; Left / Right; for right-hand traffic	9ES 120 743-001 Diffusing Lens, headlight	4
12.192 FA	140 kW		10/92→06/96	T4W / H4; Left / Right; Number of light functions: 3; 12 V / 24 V	1AG 003 434-211 Headlight	10
12.192 FAK	140 kW		10/92→06/96			
12.272 F,12.272 FL	198 kW		10/92→06/96	T4W / H4; Left / Right; Number of light functions: 3; without bulbs; for vehicles without headlamp levelling	1EF 354 340-011 Headlight	15
12.272 FK	198 kW		10/92→06/96			
12.272 FS,12.272 FLS	198 kW		10/92→06/96			
14.272 F,14.272 FL	198 kW		10/92→06/96	T4W / H4; Left / Right; Number of light functions: 3; without bulbs / with motor for headlamp levelling; for vehicles with headlamp levelling (electric)	1EF 354 340-021 Headlight	16
14.272 FK	198 kW		10/92→06/96			
14.272 FS,14.272 FLS	198 kW		12/92→06/96			
17.272 FLS	198 kW		10/92→05/95			
18.272 F,18.272 FL,18.272 FLL	198 kW		10/92→06/96	H3; Depth [mm]: 76; Left / Right; Short distance lighting; 12 V / 24 V	1G4 004 480-001 Worklight	25
18.272 FK	198 kW		10/92→06/96			
24.272 FNL,24.272 FNLL,24.272 FVL	198 kW		10/92→06/96	→ 04/93; H3; Fitting Depth [mm]: 89; Left / Right; Transparent; Number of light functions: 1; + H 166 mm; 12 V / 24 V	1NE 006 300-051 Fog Light	7
				P21W; Left / Right; Yellow; Number of light functions: 1; with lamp base	2BA 007 840-001 Indicator	47
				T4W; Lateral Mounting; Red/Black; Number of light functions: 1; with lamp base	2XS 005 020-041 Marker Lamp	45
				T4W; Lateral Mounting; Red; without lamp base; with screws	9EL 132 215-011 Lens, marker lamp	33
				H4; Left / Right; for right-hand traffic	9ES 120 743-001 Diffusing Lens, headlight	4
12.222 F,12.222 FL	162 kW		05/94→06/96	T4W / H4; Left / Right; Number of light functions: 3; 12 V / 24 V	1AG 003 434-211 Headlight	10
12.222 FA	162 kW		05/94→06/96			
12.222 FAK	162 kW		05/94→06/96			
12.222 FK	162 kW		05/94→06/96	T4W / H4; Left / Right; Number of light functions: 3; without bulbs; for vehicles without headlamp levelling	1EF 354 340-011 Headlight	15
12.222 FLS	162 kW		05/94→06/96			
12.262 F,12.262 FL	191 kW		08/95→06/96	T4W / H4; Left / Right; Number of light functions: 3; without bulbs / with motor for headlamp levelling; for vehicles with headlamp levelling (electric)	1EF 354 340-021 Headlight	16
12.262 FK	191 kW		08/95→06/96			
12.262 FS,12.262 FLS	191 kW		08/95→06/96			
12.272 FA	198 kW		10/93→04/95			
12.272 FAK	198 kW		10/93→04/95	H3; Depth [mm]: 76; Left / Right; Short distance lighting; 12 V / 24 V	1G4 004 480-001 Worklight	25
14.152 F,14.152 FL	114 kW		05/94→06/96			
14.152 FK	114 kW		05/94→06/96	P21W; Left / Right; Yellow; Number of light functions: 1; with lamp base	2BA 007 840-001 Indicator	47
14.152 FS,14.152 FLS	114 kW		05/94→06/96			
14.162 F,14.162 FL	118 kW		08/95→06/96	T4W; Lateral Mounting; Red/Black; Number of light functions: 1; with lamp base	2XS 005 020-041 Marker Lamp	45
14.162 FK	118 kW		08/95→06/96			
14.162 FS,14.162 FLS	118 kW		08/95→06/96			
14.222 F,14.222 FL	162 kW		05/94→06/96	T4W; Lateral Mounting; Red; without lamp base; with screws	9EL 132 215-011 Lens, marker lamp	33
14.222 FK	162 kW		05/94→06/96			
14.222 FLS	162 kW		05/94→06/96	H4; Left / Right; for right-hand traffic	9ES 120 743-001 Diffusing Lens, headlight	4
14.262 F,14.262 FL	191 kW		08/95→06/96			
14.262 FK	191 kW		08/95→06/96			
14.262 FS,14.262 FLS	191 kW		08/95→06/96			
17.222 FA	162 kW		05/94→06/96			
17.222 FAK	162 kW		05/94→06/96			
18.222 F,18.222 FL,18.222 FLL	162 kW		05/94→06/96			
18.222 FK	162 kW		05/94→06/96			
18.262 F,18.262 FL,18.262 FLL	191 kW		08/95→06/96			
18.262 FK	191 kW		08/95→06/96			

Manufacturer - Model	Power	Displ.	Year of Constr.	Remark	Part Number	Page
MAN - M 90			08/88→06/96			
24.222 FNL,24.222 FNLL,24.222 FVL	162 kW		05/94→06/96	T4W / H4; Left / Right; Number of light functions: 3; 12 V / 24 V	1AG 003 434-211 Headlight	10
24.262 FNL,24.262 FNLL,24.262 FVL	191 kW		08/95→06/96	T4W / H4; Left / Right; Number of light functions: 3; without bulbs; for vehicles without headlamp levelling	1EF 354 340-011 Headlight	15
				T4W / H4; Left / Right; Number of light functions: 3; without bulbs / with motor for headlamp levelling; for vehicles with headlamp levelling (electric)	1EF 354 340-021 Headlight	16
				H3; Depth [mm]: 76; Left / Right; Short distance lighting; 12 V / 24 V	1G4 004 480-001 Worklight	25
				P21W; Left / Right; Yellow; Number of light functions: 1; with lamp base	2BA 007 840-001 Indicator	47
				T4W; Lateral Mounting; Red/Black; Number of light functions: 1; with lamp base	2XS 005 020-041 Marker Lamp	45
				T4W; Lateral Mounting; Red; without lamp base; with screws	9EL 132 215-011 Lens, marker lamp	33
				H4; Left / Right; for right-hand traffic	9ES 120 743-001 Diffusing Lens, headlight	4
12.272 F,12.272 FL	198 kW		09/91→10/92	T4W / H4; Left / Right; Number of light functions: 3; 12 V / 24 V	1AG 003 434-211 Headlight	10
12.272 FK	198 kW		09/91→10/92			
12.272 FS,12.272 FLS	198 kW		09/91→10/92	T4W / H4; Left / Right; Number of light functions: 3; without bulbs; for vehicles without headlamp levelling	1EF 354 340-011 Headlight	15
14.272 F,14.272 FL	198 kW		09/91→10/92			
14.272 FK	198 kW		09/91→10/92			
14.272 FS,14.272 FLS	198 kW		09/91→10/92	T4W / H4; Left / Right; Number of light functions: 3; without bulbs / with motor for headlamp levelling; for vehicles with headlamp levelling (electric)	1EF 354 340-021 Headlight	16
				H3; Depth [mm]: 76; Left / Right; Short distance lighting; 12 V / 24 V	1G4 004 480-001 Worklight	25
				H3; Fitting Depth [mm]: 89; Left / Right; Transparent; Number of light functions: 1; + H 166 mm; 12 V / 24 V	1NE 006 300-051 Fog Light	7
				P21W; Left / Right; Yellow; Number of light functions: 1; with lamp base	2BA 007 840-001 Indicator	47
				T4W; Lateral Mounting; Red/Black; Number of light functions: 1; with lamp base	2XS 005 020-041 Marker Lamp	45
				→12/91; Additionally required articles (article numbers): 9EL 122 689-021 / 9EL 122 689-051; P21W / R10W; Left	9BG 130 945-001 Housing, combination rearlight	26
				→12/91; Additionally required articles (article numbers): 9EL 122 689-021 / 9EL 122 689-051; P21W / R10W; Right	9BG 130 946-001 Housing, combination rearlight	26
				→12/91; P21W / R10W; Left / Right; with reverse light / with reflector / with tail light / with indicator / with stop light / with fog taillight; Number of light functions: 6; without lamp base	9EL 122 689-021 Lens, combination rearlight	31
				→12/91; P21W / R10W; Left / Right; with reverse light / with reflector / with tail light / with indicator / with stop light; Number of light functions: 5; without lamp base	9EL 122 689-051 Lens, combination rearlight	32
				T4W; Lateral Mounting; Red; without lamp base; with screws	9EL 132 215-011 Lens, marker lamp	33
				H4; Left / Right; for right-hand traffic	9ES 120 743-001 Diffusing Lens, headlight	4
14.192 F,14.192 FL	137 kW		08/88→06/90	T4W / H4; Left / Right; Number of light functions: 3; 12 V / 24 V	1AG 003 434-211 Headlight	10
14.192 FA	137 kW		08/88→06/90			
14.192 FK	137 kW		08/88→06/90			
14.192 FS,14.192 FLS	137 kW		08/88→06/90	T4W / H4; Left / Right; Number of light functions: 3; without bulbs; for vehicles without headlamp levelling	1EF 354 340-011 Headlight	15
17.192 F,17.192 FL	137 kW		08/88→06/90			
17.192 FA	137 kW		02/89→06/90			
17.192 FAK	137 kW		02/89→06/90			
17.192 FK	137 kW		08/88→06/90			
17.192 FS,17.192 FLS	137 kW		08/88→06/90	T4W / H4; Left / Right; Number of light functions: 3; without bulbs / with motor for headlamp levelling; for vehicles with headlamp levelling (electric)	1EF 354 340-021 Headlight	16
				H3; Depth [mm]: 76; Left / Right; Short distance lighting; 12 V / 24 V	1G4 004 480-001 Worklight	25
				P21W; Left / Right; Yellow; Number of light functions: 1; with lamp base	2BA 007 840-001 Indicator	47
				P21W; Left / Right; Number of light functions: 1; with lamp base	2KA 003 389-081 Licence Plate Light	44
				T4W; Lateral Mounting; Red/Black; Number of light functions: 1; with lamp base	2XS 005 020-041 Marker Lamp	45
				R10W; without lamp base; with screw	9BG 121 587-031 Housing, licence plate light	27
				Additionally required articles (article numbers): 9EL 122 689-021 / 9EL 122 689-051; P21W / R10W; Left	9BG 130 945-001 Housing, combination rearlight	26

Manufacturer - Model	Power	Displ.	Year of Constr.	Remark	Part Number	Page
MAN - M 90						08/88→06/96
14.192 F,14.192 FL	137 kW		08/88→06/90	Additionally required articles (article numbers): 9EL 122 689-021 / 9EL 122 689-051; P21W / R10W; Right	9BG 130 946-001 Housing, combination rearlight	26
14.192 FA	137 kW		08/88→06/90			
14.192 FK	137 kW		08/88→06/90			
14.192 FS,14.192 FLS	137 kW		08/88→06/90	P21W / R10W; Left / Right; with reverse light / with reflector / with tail light / with indicator / with stop light / with fog taillight; Number of light functions: 6; without lamp base	9EL 122 689-021 Lens,	31
17.192 F,17.192 FL	137 kW		08/88→06/90			
17.192 FA	137 kW		02/89→06/90			
17.192 FAK	137 kW		02/89→06/90			
17.192 FK	137 kW		08/88→06/90	P21W / R10W; Left / Right; with reverse light / with reflector / with tail light / with indicator / with stop light; Number of light functions: 5; without lamp base	9EL 122 689-051 Lens,	32
17.192 FS,17.192 FLS	137 kW		08/88→06/90			
				T4W; Lateral Mounting; Red; without lamp base; with screws	9EL 132 215-011 Lens,	33
				H4; Left / Right; for right-hand traffic	9ES 120 743-001	4
					Diffusing Lens, headlight	
17.192 FK	140 kW		07/90→01/91	T4W / H4; Left / Right; Number of light functions: 3; 12 V / 24 V	1AG 003 434-211	10
17.232 FK	160 kW		05/90→01/91			
17.232 FK	169 kW		08/88→01/91	T4W / H4; Left / Right; Number of light functions: 3; without bulbs; for vehicles without headlamp levelling	1EF 354 340-011	15
				T4W / H4; Left / Right; Number of light functions: 3; without bulbs / with motor for headlamp levelling; for vehicles with headlamp levelling (electric)	1EF 354 340-021	16
				H3; Depth [mm]: 76; Left / Right; Short distance lighting; 12 V / 24 V	1G4 004 480-001	25
					Worklight	
				10/90→ ; H3; Fitting Depth [mm]: 89; Left / Right; Transparent; Number of light functions: 1; + H 166 mm; 12 V / 24 V	1NE 006 300-051 Fog	7
					Light	
				P21W; Left / Right; Yellow; Number of light functions: 1; with lamp base	2BA 007 840-001	47
					Indicator	
				P21W; Left / Right; Number of light functions: 1; with lamp base	2KA 003 389-081	44
					Licence Plate Light	
				T4W; Lateral Mounting; Red/Black; Number of light functions: 1; with lamp base	2XS 005 020-041	45
					Marker Lamp	
				R10W; without lamp base; with screw	9BG 121 587-031	27
					Housing, licence plate light	
				Additionally required articles (article numbers): 9EL 122 689-021 / 9EL 122 689-051; P21W / R10W; Left	9BG 130 945-001	26
					Housing, combination rearlight	
				Additionally required articles (article numbers): 9EL 122 689-021 / 9EL 122 689-051; P21W / R10W; Right	9BG 130 946-001	26
					Housing, combination rearlight	
				P21W / R10W; Left / Right; with reverse light / with reflector / with tail light / with indicator / with stop light / with fog taillight; Number of light functions: 6; without lamp base	9EL 122 689-021 Lens,	31
					combination rearlight	
				P21W / R10W; Left / Right; with reverse light / with reflector / with tail light / with indicator / with stop light; Number of light functions: 5; without lamp base	9EL 122 689-051 Lens,	32
					combination rearlight	
				T4W; Lateral Mounting; Red; without lamp base; with screws	9EL 132 215-011 Lens,	33
					marker lamp	
				H4; Left / Right; for right-hand traffic	9ES 120 743-001	4
					Diffusing Lens, headlight	
17.272 FLS	198 kW		09/91→05/95	T4W / H4; Left / Right; Number of light functions: 3; 12 V / 24 V	1AG 003 434-211	10
18.272 F,18.272 FL,18.272 FLL	198 kW		09/91→05/94			
18.272 FK	198 kW		09/91→05/94	T4W / H4; Left / Right; Number of light functions: 3; without bulbs; for vehicles without headlamp levelling	1EF 354 340-011	15
24.272 FNL,24.272 FVL	198 kW		09/91→05/94			
				T4W / H4; Left / Right; Number of light functions: 3; without bulbs / with motor for headlamp levelling; for vehicles with headlamp levelling (electric)	1EF 354 340-021	16
					Headlight	
				H3; Depth [mm]: 76; Left / Right; Short distance lighting; 12 V / 24 V	1G4 004 480-001	25
					Worklight	
				→04/93 ; H3; Fitting Depth [mm]: 89; Left / Right; Transparent; Number of light functions: 1; + H 166 mm; 12 V / 24 V	1NE 006 300-051 Fog	7
					Light	
				P21W; Left / Right; Yellow; Number of light functions: 1; with lamp base	2BA 007 840-001	47
					Indicator	
				T4W; Lateral Mounting; Red/Black; Number of light functions: 1; with lamp base	2XS 005 020-041	45
					Marker Lamp	
				→12/91 ; Additionally required articles (article numbers): 9EL 122 689-021 / 9EL 122 689-051; P21W / R10W; Left	9BG 130 945-001	26
					Housing, combination rearlight	
				→12/91 ; Additionally required articles (article numbers): 9EL 122 689-021 / 9EL 122 689-051; P21W / R10W; Right	9BG 130 946-001	26
					Housing, combination rearlight	

Manufacturer - Model	Power	Displ.	Year of Constr.	Remark	Part Number	Page
MAN - M 90					08/88→06/96	
17.272 FLS	198 kW		09/91→05/95	→12/91; P21W / R10W; Left / Right; with reverse light / with reflector / with tail light / with indicator / with stop light / with fog taillight; Number of light functions: 6; without lamp base →12/91; P21W / R10W; Left / Right; with reverse light / with reflector / with tail light / with indicator / with stop light; Number of light functions: 5; without lamp base T4W; Lateral Mounting; Red; without lamp base; with screws H4; Left / Right; for right-hand traffic	9EL 122 689-021 Lens, combination rearlight	31
18.272 F, 18.272 FL, 18.272 FLL	198 kW		09/91→05/94		9EL 122 689-051 Lens, combination rearlight	32
18.272 FK	198 kW		09/91→05/94		9EL 132 215-011 Lens, marker lamp	33
24.272 FNL, 24.272 FVL	198 kW		09/91→05/94		9ES 120 743-001 Diffusing Lens, headlight	4
18.192 F, 18.192 FL, 18.192 FLL	140 kW		09/90→06/96	T4W / H4; Left / Right; Number of light functions: 3; 12 V / 24 V	1AG 003 434-211 Headlight	10
18.192 FK	140 kW		09/90→06/96	T4W / H4; Left / Right; Number of light functions: 3; without bulbs; for vehicles without headlamp levelling	1EF 354 340-011 Headlight	15
18.232 F, 18.232 FL, 18.232 FLL	169 kW		09/90→06/96	T4W / H4; Left / Right; Number of light functions: 3; without bulbs / with motor for headlamp levelling; for vehicles with headlamp levelling (electric)	1EF 354 340-021 Headlight	16
18.232 FK	169 kW		09/90→06/96	H3; Depth [mm]: 76; Left / Right; Short distance lighting; 12 V / 24 V	1G4 004 480-001 Worklight	25
				→04/93; H3; Fitting Depth [mm]: 89; Left / Right; Transparent; Number of light functions: 1; + H 166 mm; 12 V / 24 V	1NE 006 300-051 Fog Light	7
				P21W; Left / Right; Yellow; Number of light functions: 1; with lamp base	2BA 007 840-001 Indicator	47
				→12/91; P21W; Left / Right; Number of light functions: 1; with lamp base	2KA 003 389-081 Licence Plate Light	44
				T4W; Lateral Mounting; Red/Black; Number of light functions: 1; with lamp base	2XS 005 020-041 Marker Lamp	45
				→12/91; R10W; without lamp base; with screw	9BG 121 587-031 Housing, licence plate light	27
				→12/91; Additionally required articles (article numbers): 9EL 122 689-021 / 9EL 122 689-051; P21W / R10W; Left	9BG 130 945-001 Housing, combination rearlight	26
				→12/91; Additionally required articles (article numbers): 9EL 122 689-021 / 9EL 122 689-051; P21W / R10W; Right	9BG 130 946-001 Housing, combination rearlight	26
				→12/91; P21W / R10W; Left / Right; with reverse light / with reflector / with tail light / with indicator / with stop light / with fog taillight; Number of light functions: 6; without lamp base	9EL 122 689-021 Lens, combination rearlight	31
				→12/91; P21W / R10W; Left / Right; with reverse light / with reflector / with tail light / with indicator / with stop light; Number of light functions: 5; without lamp base	9EL 122 689-051 Lens, combination rearlight	32
				T4W; Lateral Mounting; Red; without lamp base; with screws	9EL 132 215-011 Lens, marker lamp	33
				H4; Left / Right; for right-hand traffic	9ES 120 743-001 Diffusing Lens, headlight	4
MAN - M 2000 L					08/95→	
12.145 LC, LLC, LRC, LLRC	107 kW		05/01→	T4W / H4; Left / Right; Number of light functions: 3; without bulbs; for vehicles without headlamp levelling	1EF 354 340-011 Headlight	15
12.145 LK, LRK	107 kW		05/01→		1EF 354 340-021 Headlight	16
12.185 LC, LLC, LRC, LLRC	132 - 136 kW		05/01→	T4W / H4; Left / Right; Number of light functions: 3; without bulbs / with motor for headlamp levelling; for vehicles with headlamp levelling (electric)	2PS 354 985-001 Side Marker Light	45
12.185 LK, LRK	132 - 136 kW		05/01→			
12.225 LC, LLC, LLLC, LRC, LLRC	162 kW		05/01→	Yellow; LED; Number of light functions: 1		
12.255 LC, LLC, LLLC	180 kW		08/02→			
12.255 LK	180 kW		10/03→			
12.285 LC, LLC, LLLC	206 kW		08/02→			
12.285 LK	206 kW		10/03→			
14.185 LC, LLC, LRC, LLRC	132 - 136 kW		05/01→			
14.185 LK, LRK	132 - 136 kW		05/01→			
14.224, 14.225, LA-LF	162 kW		07/03→			
14.225 LAC, LARC, (LE220B)	162 kW		09/00→			
14.225 LAK, LARK, (LE220B)	162 kW		09/00→			
14.225 LC, LLC, LLLC, LRC, LLRC, LLLRC, (LE220B)	162 kW		09/00→			
14.225 LK, LRK (LE220B)	162 kW		09/00→			
14.255 LAC, LARC	180 kW		11/02→			
14.255 LAK, LARK	180 kW		11/02→			
14.255 LA-LF	180 kW		07/03→			
14.255 LC, LLC, LLLC, LRC, LLRC, LLLRC, (LE250B)	180 kW		09/00→			
14.255 LK, LRK	180 kW		11/02→			
14.264 LA-LF	191 kW		07/03→			

Manufacturer - Model	Power	Displ.	Year of Constr.	Remark	Part Number	Page
MAN - M 2000 L						08/95→
14.285 LC, LLC, LLLC, LRC, LLRC, LLLRC, (LE280B)	206 kW		09/00→	T4W / H4; Left / Right; Number of light functions: 3; without bulbs; for vehicles without headlamp levelling	1EF 354 340-011 Headlight	15
15.185 LC, LRC	132 - 136 kW		05/01→			
15.185 LK, LRK	132 - 136 kW		11/02→	T4W / H4; Left / Right; Number of light functions: 3; without bulbs / with motor for headlamp levelling; for vehicles with headlamp levelling (electric)	1EF 354 340-021 Headlight	16
18.224, 18.225, L-KO, LR-KO	162 kW		05/01→			
18.255 LAC, LARC	180 kW		05/01→			
18.255 LAK, LARK	180 kW		05/01→			
18.255 LK, LK, LRK, LLRK	180 kW		11/02→	Yellow; LED; Number of light functions: 1	2PS 354 985-001 Side Marker Light	45
18.255 L-KO, LR-KO	180 kW		05/01→			
18.263, 18.264, L-KO, LR-KO	191 kW		05/01→			
19.224, 19.225, LLC	162 kW		05/01→			
19.255 LLC	180 kW		05/01→			
19.264 LLC	191 kW		05/01→			
19.284, 19.285, LLC	206 kW		05/01→			
20.224 LNLC, LNLLC	162 kW		05/01→			
20.255 LNLC, LNLLC	180 kW		05/01→			
20.264 LNLC, LNLLC	191 kW		05/01→			
20.284, 20.285, LNLC, LNLLC	206 kW		05/01→			
26.224, 26.225, DL-HK, DLR-HK	180 kW		11/02→			
26.255 DL-HK, DLR-HK	180 kW		11/02→			
26.284, 26.285, DL-HK, DLR-HK	206 kW		11/02→			
26.284 DL-TM, DLR-TM	206 kW		05/01→			
12.163 LC, LLC, LRC, LLRC	114 kW		08/95→	T4W / H4; Left / Right; Number of light functions: 3; without bulbs; for vehicles without headlamp levelling	1EF 354 340-011 Headlight	15
12.163 LK, LRK	114 kW		08/95→			
12.224, 12.225, LK, LRK	162 kW		08/95→			
12.224 LC, LLC, LRC, LLRC	162 kW		08/95→	T4W / H4; Left / Right; Number of light functions: 3; without bulbs / with motor for headlamp levelling; for vehicles with headlamp levelling (electric)	1EF 354 340-021 Headlight	16
14.163 LC, LLC, LRC, LLRC	114 kW		08/95→			
14.163 LK, LRK	114 kW		08/95→			
14.224 LAC, LARC	162 kW		08/95→			
14.224 LAK, LARK	162 kW		08/95→	→08/00; P21W; Left / Right; Yellow; Number of light functions: 1; with lamp base	2BA 007 839-001 Indicator	46
14.224 LC, LLC, LLLC, LRC, LLRC, LLLRC	162 kW		08/95→	Yellow; LED; Number of light functions: 1	2PS 354 985-001 Side Marker Light	45
14.224 LK, LRK	162 kW		08/95→			
14.263, 14.264 LAC, LARC	191 kW		08/95→	P21W / R5W; Left / Right; Number of light functions: 8; 24 V; with lamp base	2VD 008 204-051 Combination Rearlight	36
14.263, 14.264 LAK, LARK	191 kW		08/95→			
14.263, 14.264 LC, LLC, LLLC, LRC, LLRC, LLLRC	191 kW		08/95→	P21W / R5W; Left; Number of light functions: 9; 24 V; with lamp base	2VD 008 204-071 Combination Rearlight	37
14.263, 14.264 LK, LRK	191 kW		08/95→			
14.284, 14.285, LAC, LARC	206 kW		06/98→	P21W / R5W; Left / Right; Number of light functions: 7; 24 V; with lamp base	2VP 008 204-041 Combination Rearlight	41
14.284, 14.285, LAK, LARK	206 kW		06/98→			
14.284, 14.285, LA-LF	206 kW		06/98→	P21W / R5W; Left / Right; Number of light functions: 8; 24 V; with lamp base	2VP 008 204-061 Combination Rearlight	42
14.284, 14.285, LK, LRK	206 kW		10/98→			
14.284 LC, LLC, LLLC, LRC, LLRC, LLLRC	206 kW		10/98→	P21W / R5W; Left / Right; Number of light functions: 5; without lamp base; with screws	9EL 152 889-001 Lens, combination rearlight	33
15.163 LC, LLC, LRC	114 kW		08/95→			
15.163 LK, LRK	114 kW		08/95→			
15.224 LC, LLC, LLLC, LRC, LLRC, LLLRC	162 kW		08/95→			
15.224 LK, LRK	162 kW		08/95→			
15.263, 15.264 LC, LLC, LLLC, LRC, LLRC, LLLRC	191 kW		08/95→			
15.263, 15.264 LK, LRK	191 kW		08/95→			
15.284 LC, LLC, LLLC, LRC, LLRC, LLLRC	206 kW		06/98→			
15.284 LK, LRK	206 kW		06/98→			
18.224, 18.225, LAC, LARC	162 kW		08/95→			
18.224, 18.225, LAK, LARK	162 kW		08/95→			
18.224, 18.225, LC, LLC, LLLC, LRC, LLRC, LLLRC	162 kW		08/95→			
18.224, 18.225, LK, LK, LRK, LLRK	162 kW		08/95→			
18.263, 18.264, LAC, LARC	191 kW		08/95→			
18.263, 18.264, LAK, LARK	191 kW		08/95→			
18.263, 18.264, LC, LLC, LLLC, LRC, LLRC, LLLRC	191 kW		08/95→			
18.263, 18.264, LK, LK, LRK, LLRK	191 kW		08/95→			
18.284, 18.285, LK, LK, LRK, LLRK	206 kW		06/98→			
18.284, 18.285, L-KO, LR-KO	206 kW		06/98→			
18.284 LAC, LARC	206 kW		06/98→			
18.284 LAK, LARK	206 kW		06/98→			

Manufacturer - Model	Power	Displ.	Year of Constr.	Remark	Part Number	Page
MAN - M 2000 L						08/95→
15.225 LC, LLC, LLLC, LRC, LLRC, LLLRC, (LE220B)	162 kW		09/99→	T4W / H4; Left / Right; Number of light functions: 3; without bulbs; for vehicles without headlamp levelling	1EF 354 340-011 Headlight	15
15.225 LK, LRK, (LE220B)	162 kW		09/99→			
15.255 LC, LLC, LLLC, LRC, LLRC, LLLRC, (LE250B)	180 kW		09/99→	T4W / H4; Left / Right; Number of light functions: 3; without bulbs / with motor for headlamp levelling; for vehicles with headlamp levelling (electric)	1EF 354 340-021 Headlight	16
15.255 LK, LRK, (LE250B)	180 kW		09/99→			
15.285 LC, LLC, LLLC, LRC, LLRC, LLLRC, (LE280B)	206 kW		09/99→	-08/00; P21W; Left / Right; Yellow; Number of light functions: 1; with lamp base	2BA 007 839-001 Indicator	46
15.285 LK, LRK, (LE280B)	206 kW		09/99→			
18.255 LC, LLC, LLLC, LRC, LLRC, LLLRC, (LE250B)	180 kW		09/99→	Yellow; LED; Number of light functions: 1	2PS 354 985-001 Side Marker Light	45
18.285 LAC, LARC (LE280B)	206 kW		09/99→			
18.285 LAK, LARK, (LE280B)	206 kW		09/99→			
18.285 LC, LLC, LLLC, LRC, LLRC, LLLRC, (LE280B)	206 kW		09/99→			
MAN - M 2000 M						08/95→
18.284 LC, LLC, LLLC, LRC, LLRC, LLLRC	206 kW		06/98→	T4W / H4; Left / Right; Number of light functions: 3; without bulbs; for vehicles without headlamp levelling	1EF 354 340-011 Headlight	15
				T4W / H4; Left / Right; Number of light functions: 3; without bulbs / with motor for headlamp levelling; for vehicles with headlamp levelling (electric)	1EF 354 340-021 Headlight	16
				P21W; Left / Right; Yellow; Number of light functions: 1; with lamp base	2BA 007 839-001 Indicator	46
				Yellow; LED; Number of light functions: 1	2PS 354 985-001 Side Marker Light	45
				P21W / R5W; Left / Right; Number of light functions: 8; 24 V; with lamp base	2VD 008 204-051 Combination Rearlight	36
				P21W / R5W; Left; Number of light functions: 9; 24 V; with lamp base	2VD 008 204-071 Combination Rearlight	37
				P21W / R5W; Left / Right; Number of light functions: 7; 24 V; with lamp base	2VP 008 204-041 Combination Rearlight	41
				P21W / R5W; Left / Right; Number of light functions: 8; 24 V; with lamp base	2VP 008 204-061 Combination Rearlight	42
				P21W / R5W; Left / Right; Number of light functions: 5; without lamp base; with screws	9EL 152 889-001 Lens, combination rearlight	33
12.224 MC, MLC	162 kW		02/03→	P21W / W5W / H7 / H7; Left; Number of light functions: 4; with bulbs; for vehicles without headlamp levelling	1D3 009 027-011 Headlight	12
12.224 MLS	162 kW		02/03→			
12.255 MC, MLC	180 kW		02/03→	P21W / W5W / H7 / H7; Right; Number of light functions: 4; with bulbs; for vehicles without headlamp levelling	1D3 009 027-021 Headlight	13
12.255 MLS	180 kW		02/03→			
12.264 MC, MLC	191 kW		02/03→	P21W / W5W / H7 / H7; Left; Number of light functions: 4; with bulbs; for vehicles with headlamp levelling (electric)	1D3 009 027-031 Headlight	14
12.264 MLS	191 kW		02/03→			
12.284 MC, MLC	206 kW		02/00→	P21W / W5W / H7 / H7; Right; Number of light functions: 4; with bulbs; for vehicles with headlamp levelling (electric)	1D3 009 027-041 Headlight	14
12.284 MLS	206 kW		02/00→			
14.224 MAK	162 kW		08/95→12/05	T4W / H4; Left / Right; Number of light functions: 3; without bulbs; for vehicles without headlamp levelling	1EF 354 340-011 Headlight	15
14.224 MA-KO, MA-LF	162 kW		11/02→			
14.224 MC, MLC, MLLC	162 kW		08/95→12/05	T4W / H4; Left / Right; Number of light functions: 3; without bulbs / with motor for headlamp levelling; for vehicles with headlamp levelling (electric)	1EF 354 340-021 Headlight	16
14.224 MK	162 kW		08/95→12/05			
14.224 MLS, MLRS	162 kW		08/95→12/05			
14.225 MC, MLC, MLLC	162 kW		10/00→	H3; Left; with high beam / with fog light; Number of light functions: 2; with bulbs	1NB 354 986-071 Spotlight	6, 24
14.225 MLS, MLRS	162 kW		02/03→			
14.255 MAK	180 kW		11/02→	H3; Left; with high beam / with fog light; Number of light functions: 2; with bulbs	1NB 354 986-071 Fog Light	6, 24
14.255 MA-KO, MA-LF	180 kW		11/02→			
14.255 MC, MLC, MLLC	180 kW		10/00→	H3; Right; with high beam / with fog light; Number of light functions: 2; with bulbs	1NB 354 986-081 Spotlight	6, 24
14.255 MLS, MLRS	180 kW		10/00→			
14.264 MAK	191 kW		11/02→	H3; Right; with high beam / with fog light; Number of light functions: 2; with bulbs	1NB 354 986-081 Fog Light	6, 24
14.264 MA-KO, MA-LF	191 kW		11/02→			
14.264 MC, MLC, MLLC	191 kW		08/95→12/05	Yellow; LED; Number of light functions: 1	2PS 354 985-001 Side Marker Light	45
14.264 MLS, MLRS	191 kW		08/95→12/05			
14.284 MAK	206 kW		06/98→12/05	P21W / R5W; Left / Right; Number of light functions: 8; 24 V; with lamp base	2VD 008 204-051 Combination Rearlight	36
14.284 MA-KO, MA-LF	206 kW		06/98→12/05			
14.284 MC, MLC, MLLC	206 kW		06/98→12/05	P21W / R5W; Left; Number of light functions: 9; 24 V; with lamp base	2VD 008 204-071 Combination Rearlight	37
14.284 MLS, MLRS	206 kW		06/98→12/05			
14.285 MLC, MLLC (ME280C)	206 kW		09/99→12/05	P21W / R5W; Left / Right; Number of light functions: 7; 24 V; with lamp base	2VP 008 204-041 Combination Rearlight	41
14.285 MLS, MLRS	206 kW		02/03→			
18.224 MAC, MARC	162 kW		08/95→12/05	P21W / R5W; Left / Right; Number of light functions: 8; 24 V; with lamp base	2VP 008 204-061 Combination Rearlight	42
18.224 MAK, MARK	162 kW		08/95→12/05			
18.224 MC, MLC, MLLC, MRC, MLRC, MLLRC	162 kW		08/95→12/05	P21W / R5W; Left / Right; Number of light functions: 5; without lamp base; with screws	9EL 152 889-001 Lens, combination rearlight	33
18.224 MK, 18.224 MLK, MRK, MLRK	162 kW		08/95→12/05			
18.224 M-KO, MR-KO	162 kW		02/00→			
18.224 MLS, MLRS	162 kW		08/95→12/05			
18.225 MAC, MARC	162 kW		02/03→			
18.225 MC, MLC, MLLC, MRC, MLRC, MLLRC	162 kW		10/00→			
18.255 MAC, MARC	180 kW		10/00→			
18.255 MAK, MARK	180 kW		10/00→			

Manufacturer - Model	Power	Displ.	Year of Constr.	Remark	Part Number	Page
MAN - M 2000 M						08/95→
18.255 MC, MLC, MLLC, MLRC, MLLRC	180 kW		10/00→	P21W / W5W / H7 / H7; Left; Number of light functions: 4; with bulbs; for vehicles without headlamp levelling	1D3 009 027-011 Headlight	12
18.255 MK, MLK, MRK, MLRK	180 kW		11/02→	P21W / W5W / H7 / H7; Right; Number of light functions: 4; with bulbs; for vehicles without headlamp levelling	1D3 009 027-021 Headlight	13
18.255 M-KO, MR-KO	180 kW		10/00→			
18.255 MLS, MLRS	180 kW		10/00→			
18.264 MAC, MARC	191 kW		08/95→12/05	P21W / W5W / H7 / H7; Left; Number of light functions: 4; with bulbs; for vehicles with headlamp levelling (electric)	1D3 009 027-031 Headlight	14
18.264 MAK, MARK	191 kW		08/95→12/05			
18.264 MC, MLC, MLLC, MRC, MLRC, MLLRC	191 kW		08/95→12/05			
18.264 MK, 18.264 MLK, MRK, MLRK	191 kW		08/95→12/05	P21W / W5W / H7 / H7; Right; Number of light functions: 4; with bulbs; for vehicles with headlamp levelling (electric)	1D3 009 027-041 Headlight	14
18.264 M-KO, MR-KO	191 kW		02/00→	T4W / H4; Left / Right; Number of light functions: 3; without bulbs; for vehicles without headlamp levelling	1EF 354 340-011 Headlight	15
18.264 MLS, MLRS	191 kW		08/95→12/05			
18.284 MAC, MARC	206 kW		06/98→12/05	T4W / H4; Left / Right; Number of light functions: 3; without bulbs / with motor for headlamp levelling; for vehicles with headlamp levelling (electric)	1EF 354 340-021 Headlight	16
18.284 MAK, MARK	206 kW		06/98→12/05			
18.284 MC, MLC, MLLC, MRC, MLRC, LLRC	206 kW		06/98→12/05			
18.284 MK, 18.284 MLK, MRK, MLRK	206 kW		06/98→12/05	H3; Left; with high beam / with fog light; Number of light functions: 2; with bulbs	1NB 354 986-071 Spotlight	6, 24
18.284 M-KO, MR-KO	206 kW		02/00→			
18.284 MLS, MLRS	206 kW		06/98→12/05	H3; Left; with high beam / with fog light; Number of light functions: 2; with bulbs	1NB 354 986-071 Fog Light	6, 24
18.285 MAC, MARC	206 kW		02/03→			
18.285 MC, MLC, MLLC	206 kW		06/98→12/05	H3; Right; with high beam / with fog light; Number of light functions: 2; with bulbs	1NB 354 986-081 Spotlight	6, 24
18.285 MLS, MLRS	206 kW		02/03→			
25.224 MNLC, MNLLC, MNLRC, MNLLRC, MVLC	162 kW		08/95→12/05	H3; Right; with high beam / with fog light; Number of light functions: 2; with bulbs	1NB 354 986-081 Fog Light	6, 24
25.225 MNLC, MNLLC, MNLRC, MNLLRC, MVLC	162 kW		02/03→	Yellow; LED; Number of light functions: 1	2PS 354 985-001 Side Marker Light	45
25.255 MNLC, MNLLC, MNLRC, MNLLRC, MVLC	180 kW		10/00→			
25.264 MNLC, MNLLC, MNLRC, MNLLRC, MVLC	191 kW		08/95→12/05	P21W / R5W; Left / Right; Number of light functions: 8; 24 V; with lamp base	2VD 008 204-051 Combination Rearlight	36
25.284 MNLC, MNLLC, MNLRC, MNLLRC, MVLC	206 kW		02/00→	P21W / R5W; Left; Number of light functions: 9; 24 V; with lamp base	2VD 008 204-071 Combination Rearlight	37
25.285 MNLC, MNLLC, MNLRC, MNLLRC, MVLC	206 kW		02/03→	P21W / R5W; Left / Right; Number of light functions: 7; 24 V; with lamp base	2VP 008 204-041 Combination Rearlight	41
				P21W / R5W; Left / Right; Number of light functions: 8; 24 V; with lamp base	2VP 008 204-061 Combination Rearlight	42
				P21W / R5W; Left / Right; Number of light functions: 5; without lamp base; with screws	9EL 152 889-001 Lens, combination rearlight	33
MAN - NG						08/92→
NG 262	191 kW		06/97→07/98	T4W / H4; Left / Right; Number of light functions: 3; 12 V / 24 V	1AG 003 434-211 Headlight	10
NG 262, NG 263	191 kW		07/98→			
NG 312	228 kW		09/95→07/98			
NG 312, NG 313	228 kW		07/98→			
NG 313	228 kW					
NG 323	235 kW					
NG 353	257 kW					
NG 363	264 kW					
NG 262, NG 272	191 - 198 kW		08/92→07/98	T4W / H4; Left / Right; Number of light functions: 3; 12 V / 24 V	1AG 003 434-211 Headlight	10
				T4W / H4; Depth [mm]: 198; Left / Right; Manufacturer Restriction: Ref. 25/37,5; Number of light functions: 3; without indicator lamp; for vehicles with headlamp levelling	1AG 003 434-251 Headlight	11
				P21W / R10W; Left; Number of light functions: 3; 12 V / 24 V; with lamp base	2SD 003 167-531 Combination Rearlight	34
				P21W / R10W; Right; Number of light functions: 3; 12 V / 24 V; with lamp base	2SD 003 167-541 Combination Rearlight	35
				P21W / R10W; Left / Right; Number of light functions: 4; without lamp base; with screws	9EL 147 747-001 Lens, combination rearlight	32
				H4; Left / Right; for right-hand traffic	9ES 120 743-001 Diffusing Lens, headlight	4
MAN - NL						09/89→
NL 202	157 kW		09/89→04/94	T4W / H4; Left / Right; Number of light functions: 3; 12 V / 24 V	1AG 003 434-211 Headlight	10
				T4W / H4; Depth [mm]: 198; Left / Right; Manufacturer Restriction: Ref. 25/37,5; Number of light functions: 3; without indicator lamp; for vehicles with headlamp levelling	1AG 003 434-251 Headlight	11
				P21W / R10W; Left; Number of light functions: 3; 12 V / 24 V; with lamp base	2SD 003 167-531 Combination Rearlight	34
				P21W / R10W; Right; Number of light functions: 3; 12 V / 24 V; with lamp base	2SD 003 167-541 Combination Rearlight	35
				H4; Left / Right; for right-hand traffic	9ES 120 743-001 Diffusing Lens, headlight	4

Manufacturer - Model	Power	Displ.	Year of Constr.	Remark	Part Number	Page
MAN - NL						09/89→
NL 202, NL 222, NL 223 NL 202, NL 262, NL 263	157 - 162 kW 184 kW		08/92→ 04/91→	T4W / H4; Left / Right; Number of light functions: 3; 12 V / 24 V	1AG 003 434-211 Headlight	10
				T4W / H4; Depth [mm]: 198; Left / Right; Manufacturer Restriction: Ref. 25/37,5; Number of light functions: 3; without indicator lamp; for vehicles with headlamp levelling	1AG 003 434-251 Headlight	11
				H4; Left / Right; for right-hand traffic	9ES 120 743-001 Diffusing Lens, headlight	4
NL 243 NL 262 NL 262, NL 263 NL 273 NL 283 NL 312 NL 313 NL 313 NL 323	180 kW 191 kW 191 kW 199 kW 206 kW 228 kW 228 kW 228 kW 235 kW		06/97→ 07/98→ 11/95→07/98 07/98→	T4W / H4; Left / Right; Number of light functions: 3; 12 V / 24 V	1AG 003 434-211 Headlight	10
MAN - NM						08/87→
NM 152 NM 152	110 kW 114 kW		05/90→10/93 04/92→03/97	T4W / H4; Left / Right; Number of light functions: 3; 12 V / 24 V	1AG 003 434-211 Headlight	10
				T4W / H4; Depth [mm]: 198; Left / Right; Manufacturer Restriction: Ref. 25/37,5; Number of light functions: 3; without indicator lamp; for vehicles with headlamp levelling	1AG 003 434-251 Headlight	11
				P21W / R10W; Left; Number of light functions: 3; 12 V / 24 V; with lamp base	2SD 003 167-531 Combination Rearlight	34
				P21W / R10W; Right; Number of light functions: 3; 12 V / 24 V; with lamp base	2SD 003 167-541 Combination Rearlight	35
				H4; Left / Right; for right-hand traffic	9ES 120 743-001 Diffusing Lens, headlight	4
NM 182, NM 192 NM 222, NM 223 NM 223 NM 243 NM 253 NM 283 NM 293	130 - 140 kW 162 kW 162 kW 176 kW 184 kW 206 kW 213 kW		05/90→03/97 02/96→ 08/87→	T4W / H4; Left / Right; Number of light functions: 3; 12 V / 24 V	1AG 003 434-211 Headlight	10
MAN - SG						09/85→04/94
SG 242, SG 292	224 - 229 kW		09/85→04/94	05/91→ ; T4W / H4; Depth [mm]: 198; Left / Right; Manufacturer Restriction: Ref. 25/37,5; Number of light functions: 3; without indicator lamp; for vehicles with headlamp levelling	1AG 003 434-251 Headlight	11
				H3; Left / Right; Number of light functions: 1; 24 V	1NB 003 367-137 Fog Light	5
				P21W; Left / Right; Number of light functions: 1; with lamp base	2KA 003 389-081 Licence Plate Light	44
				P21W / R10W; Left; Number of light functions: 3; 12 V / 24 V; with lamp base	2SD 003 167-531 Combination Rearlight	34
				P21W / R10W; Right; Number of light functions: 3; 12 V / 24 V; with lamp base	2SD 003 167-541 Combination Rearlight	35
				R10W; without lamp base; with screw	9BG 121 587-031 Housing, licence plate light	27
				P21W / R10W; Left / Right; Number of light functions: 4; without lamp base; with screws	9EL 147 747-001 Lens, combination rearlight	32
				H4; Left / Right; for right-hand traffic	9ES 120 743-001 Diffusing Lens, headlight	4
MAN - SL						05/80→04/87
SL 200 SL 200	147 - 150 kW 177 kW		05/80→04/87 05/80→01/86	07/82→ ; P21W / R10W; Left; Number of light functions: 3; 12 V / 24 V; with lamp base	2SD 003 167-531 Combination Rearlight	34
				07/82→ ; P21W / R10W; Right; Number of light functions: 3; 12 V / 24 V; with lamp base	2SD 003 167-541 Combination Rearlight	35
				07/82→ ; P21W / R10W; Left / Right; Number of light functions: 4; without lamp base; with screws	9EL 147 747-001 Lens, combination rearlight	32
SL 200	177 kW		01/86→04/87	P21W / R10W; Left; Number of light functions: 3; 12 V / 24 V; with lamp base	2SD 003 167-531 Combination Rearlight	34
				P21W / R10W; Right; Number of light functions: 3; 12 V / 24 V; with lamp base	2SD 003 167-541 Combination Rearlight	35
				P21W / R10W; Left / Right; Number of light functions: 4; without lamp base; with screws	9EL 147 747-001 Lens, combination rearlight	32

Manufacturer - Model	Power	Displ.	Year of Constr.	Remark	Part Number	Page
MAN - SL II					06/84→04/94	
SL 202	147 - 155 kW		06/84→04/93	03/88→ ; T4W / H4; Depth [mm]: 198; Left / Right; Manufacturer Restriction: Ref. 25/37,5; Number of light functions: 3; without indicator lamp; for vehicles with headlamp levelling	1AG 003 434-251 Headlight	11
SL 202	177 - 180 kW		06/84→04/94	H3; Left / Right; Number of light functions: 1; 24 V	1NB 003 367-137 Fog Light	5
				02/86→ ; P21W; Left / Right; Number of light functions: 1; with lamp base	2KA 003 389-081 Licence Plate Light	44
				P21W / R10W; Left; Number of light functions: 3; 12 V / 24 V; with lamp base	2SD 003 167-531 Combination Rearlight	34
				P21W / R10W; Right; Number of light functions: 3; 12 V / 24 V; with lamp base	2SD 003 167-541 Combination Rearlight	35
				02/86→ ; R10W; without lamp base; with screw	9BG 121 587-031 Housing, licence plate light	27
				H4; Left / Right; for right-hand traffic	9ES 120 743-001 Diffusing Lens, headlight	4
MAN - SM					11/87→02/95	
SM 152	110 - 114 kW		11/87→04/94	T4W / H4; Left / Right; Number of light functions: 3; 12 V / 24 V	1AG 003 434-211 Headlight	10
SM 182, SM 192	130 - 140 kW		11/87→02/95			
MAN - SÜ					10/75→09/89	
SÜ 240	147 - 150 kW		05/80→09/89	07/82→ ; P21W / R10W; Left; Number of light functions: 3; 12 V / 24 V; with lamp base	2SD 003 167-531 Combination Rearlight	34
SÜ 240	177 kW		10/75→01/86	07/82→ ; P21W / R10W; Right; Number of light functions: 3; 12 V / 24 V; with lamp base	2SD 003 167-541 Combination Rearlight	35
				07/82→ ; P21W / R10W; Left / Right; Number of light functions: 4; without lamp base; with screws	9EL 147 747-001 Lens, combination rearlight	32
SÜ 240	177 kW		01/86→09/89	P21W / R10W; Left; Number of light functions: 3; 12 V / 24 V; with lamp base	2SD 003 167-531 Combination Rearlight	34
SÜ 240	206 kW		11/82→01/86	P21W / R10W; Right; Number of light functions: 3; 12 V / 24 V; with lamp base	2SD 003 167-541 Combination Rearlight	35
SÜ 240	213 kW		01/86→09/89	P21W / R10W; Left / Right; Number of light functions: 4; without lamp base; with screws	9EL 147 747-001 Lens, combination rearlight	32
MAN - TGA					04/00→	
18.310, 18.320 FAC, FHLC	228 - 235 kW		05/04→	W5W / H7 / H7; Left; Number of light functions: 3; with bulbs; for vehicles without headlamp levelling	1EH 354 984-011 Headlight	16
18.310, 18.320 FAK, FAK-L, FALK, FALK-L, FHLK, FHLK/M	228 - 235 kW		05/04→	W5W / H7 / H7; Right; Number of light functions: 3; with bulbs; for vehicles without headlamp levelling	1EH 354 984-021 Headlight	16
18.310, 18.320 FAS, FALS, FHLS, FHLS/M	228 - 235 kW		05/04→	W5W / H7 / H7; Left; Number of light functions: 3; with bulbs; for vehicles with headlamp levelling (electric)	1EH 354 984-031 Headlight	17
18.310, 18.320 FC, FLC, FLLC, FLLC/N, FLLW, FLLW/N	228 - 235 kW		05/04→	W5W / H7 / H7; Right; Number of light functions: 3; with bulbs; for vehicles with headlamp levelling (electric)	1EH 354 984-041 Headlight	17
18.310, 18.320 FK, FK-L, FLK, FLK/M	228 - 235 kW		05/04→	P21W / H4; Left; Yellow; with indicator / with high beam / with fog light; Number of light functions: 3; with bulbs	1NB 354 986-031 Spotlight	5, 23
18.310, 18.320 FLS, FLRS, FLLS, FLLRS	228 - 235 kW		05/04→	P21W / H4; Left; Yellow; with indicator / with high beam / with fog light; Number of light functions: 3; with bulbs	1NB 354 986-031 Fog Light	5, 23
18.310, 18320 FC, FLC, FRC, FLLC, FLLC/N, FLLW, FLLRC, FLLRW	228 - 235 kW		04/00→	P21W / H4; Right; Yellow; with indicator / with high beam / with fog light; Number of light functions: 3; with bulbs	1NB 354 986-041 Spotlight	6, 24
18.310, 18320 FK, FLK, FK-L, FLRK	228 - 235 kW		12/00→	P21W / H4; Right; Yellow; with indicator / with high beam / with fog light; Number of light functions: 3; with bulbs	1NB 354 986-041 Fog Light	6, 24
18.310 FAC, FARC	228 kW		09/02→	H4 / PY21W; Left; White; with indicator / with high beam / with fog light; Number of light functions: 3; with bulbs	1NB 354 986-051 Spotlight	6, 24
18.310 FAK, FAK-L, FALK	228 kW		09/02→	H4 / PY21W; Left; White; with indicator / with high beam / with fog light; Number of light functions: 3; with bulbs	1NB 354 986-051 Fog Light	6, 24
18.310 FAS, FARS	228 kW		09/02→	H4 / PY21W; Right; White; with indicator / with high beam / with fog light; Number of light functions: 3; with bulbs	1NB 354 986-061 Spotlight	6, 24
18.310 FLS, FLLS, FLLS/N, FLS-TS, FLRS, FLLRS	228 kW		04/00→	H4 / PY21W; Right; White; with indicator / with high beam / with fog light; Number of light functions: 3; with bulbs	1NB 354 986-061 Fog Light	6, 24
18.350, 18.360 FAC, FHLC	257 - 265 kW		05/04→	P21W / Left / Right; Number of light functions: 1; with lamp base	2KA 003 389-081 Licence Plate Light	44
18.350, 18.360 FAK, FAK-L, FALK, FALK-L, FHLK, FHLK/M	257 - 265 kW		05/04→	Front; White; Number of light functions: 1	2PF 354 985-011 Position Light	45
18.350, 18.360 FAS, FALS, FHLS, FHLS/M	257 - 265 kW		05/04→	Yellow; LED; Number of light functions: 1	2PS 354 985-001 Side Marker Light	45
18.350, 18.360 FC, FLC, FLLC, FLLRC, FLLC/N, FLLW, FLLW/N	257 - 265 kW		05/04→			
18.350, 18.360 FK, FK-L, FLK, FLK/M,	257 - 265 kW		05/04→			
18.350 FLS, FLS/N, FLS/M, FLS-TS, FLLS, FLLS/N, FLLRS	257 kW		05/04→			
18.360 FAC, FARC	265 kW		09/02→			
18.360 FAK, FALK, FAK-L, FALK-L	265 kW		09/02→			
18.360 FAS, FALS, FARS	265 kW		09/02→			
18.360 FC, FLC, FRC, FLLC, FLLC/N, FLLW, FLLRW	265 kW		04/00→			
18.360 FK, FLK, FK-L, FLRK	265 kW		12/00→			
18.360 FLS, FLLS, FLLS/N, FLS-TS, FLRS, FLLRS	265 kW		04/00→			

Manufacturer - Model	Power	Displ.	Year of Constr.	Remark	Part Number	Page
MAN - TGA						04/00→
18.390, 18.400 FAC, FHLC	287 - 294 kW		05/04→	→05/05; P21W / R5W; Left; Number of light functions: 9; 12 V / 24 V; with lamp base	2VD 008 204-251	38
18.390, 18.400 FAK, FAK-L, FALK, FALK-L, FHLK, FHLK/M	287 - 294 kW		05/04→		Combination Rearlight	
18.390, 18.400 FAS, FALS, FHLS, FHLS/M	287 - 294 kW		05/04→	→05/05; P21W / R5W; Right; Number of light functions: 8; 12 V / 24 V; with lamp base	2VP 008 204-241	43
18.390, 18.400 FC, FLC, FLLC, FLLC/N, FLLW, FLLW/N	287 - 294 kW		05/04→		R10W; without lamp base; with screw	9BG 121 587-031
18.390, 18.400 FK, FK-L, FLK, FLK/M	287 - 294 kW		05/04→	→05/05; P21W / R5W; Left / Right; Number of light functions: 5; without lamp base; with screws	9EL 152 889-001	33
18.390 FLS, FLS-TS, FLS/M, FLLS, FLLS/N, FLLS/M, FLLRS	287 kW		05/04→		Left; without gasket / seal	9ES 354 984-051
18.410, 18420 FAK, FAK-L, FALK	301 - 309 kW		09/02→	Right; without gasket / seal	9ES 354 984-061	4
18.410, 18420 FC, FRC, FLC, FLRC, FLLC, FLLC/N, FLLW, FLLRC	301 - 309 kW		04/00→		Diffusing Lens, headlight	
18.410, 18420 FK, FK-L, FLK, FLRK	301 - 309 kW		12/00→			
18.410 FAC, FARC	301 kW		09/02→			
18.410 FAS, FALS, FARS	301 kW		09/02→			
18.410 FLS, FLS, FLLS, FLLS/N, FLS-TS, FLRS, FLLRS	301 kW		04/00→			
18.430, 18.440 FAC, FHLC	316 - 324 kW		05/04→			
18.430, 18.440 FAK, FALK, FALK-L, FHLK, FHLK/M	316 - 324 kW		05/04→			
18.430, 18.440 FAS, FALS, FHLS, FHLS/M	316 - 324 kW		05/04→			
18.430, 18.440 FC, FLC, FLLC, FLLW, FLLW/N, FLLRC, FLLRW	316 - 324 kW		05/04→			
18.430, 18.440 FK, FK-L, FLK, FLK/M	316 - 324 kW		05/04→			
18.430 FLS, FLS/M, FLS-TS, FLLS, FLLS/N, FLLRS, FLRS	316 kW		05/04→			
18.460 FAK	338 kW		12/00→			
18.460 FC, FLC, FRC, FLLC, FLLC/N, FLLW, FLLRC, FLLRW	338 kW		04/00→			
18.460 FK, FK-L, FLK, FLRK	338 kW		12/00→			
18.460 FLS, FLS, FLLS, FLLS/N, FLS-TS, FLRS, FLLRS	338 kW		04/00→			
18.480 FAC, FARC	353 kW		09/02→			
18.480 FAK, FAK-L, FALK	353 kW		09/02→			
18.480 FAS, FALS, FARS	353 kW		09/02→			
18.480 FC, FLC, FLLC, FLLW, FLLRW, FLLRC	353 kW		09/02→			
18.480 FK, FLK, FK-L	353 kW		09/02→			
18.480 FLS, FLS, FLLS, FLLS/N, FLS-TS, FLRS-WW	353 kW		09/02→			
18.510 FC, FLC, FRC, FLLC, FLLC/N, FLLW, FLLRC, FLLRW	375 kW		09/00→			
18.510 FLS, FLS, FLLS, FLLS/N, FLRS, FLLRS	375 kW		04/00→			
18.530 FAC	390 kW		04/04→			
18.530 FAK, FALK	390 kW		04/04→			
18.530 FAS, FALS	390 kW		04/04→			
18.530 FC, FLC, FLLC, FLLC/N, FLLW, FLLRC, FLLRW	390 kW		09/02→			
18.530 FLS, FLS, FLLS, FLLS/N	390 kW		09/02→			
19.350 FS, FRS, FLS, FLRS-WW	257 kW		05/04→			
19.360 FS, FRS, FLS, FLRS-WW	265 kW		05/04→			
19.360 FS/M-WW, FRS/M-WW	265 kW		05/04→			
19.390 FS, FRS, FLS, FLRS-WW	287 kW		05/04→			
19.400 FS/M-WW, FRS/M-WW, FLS, FLRS	294 kW		05/04→			
19.410 FS/M-WW, FRS/M-WW	301 kW		05/04→			
19.430 FS/M-WW, FLS, FRS, FLRS	316 kW		05/04→			
19.460 FS/M-WW, FRS/M-WW	338 kW		05/04→			
19.480 FS/M-WW, FRS/M-WW	353 kW		05/04→			
24.350, 24.360 FNLLC, FNLLW/N, FNLLRW	257 - 265 kW		05/04→			
24.350, 24.360 FPLS, FPLRS	257 - 265 kW		02/04→			
24.360 FNLLC/N, FNLLW, FNLLRW, FNLLRC	265 kW		09/01→			
24.390, 24.400 FNLLC/N, FNLLW/N, FNLLRC, FNLLRW	287 - 294 kW		05/04→			
24.390, 24.400 FPLS, FPLRS	287 - 294 kW		05/04→			
24.410 FNLLC/N, FNLLW, FNLLRW	301 kW		09/01→			
24.430, 24.440 FNLLC/N, FNLR, FNLLW	316 - 324 kW		05/04→			
24.430, 24.440 FPLS, FPLRS	316 - 324 kW		05/04→			

Manufacturer - Model	Power	Displ.	Year of Constr.	Remark	Part Number	Page
MAN - TGA						04/00→
24.460 FNLLC/N, FNLLW, FNLLRC, FNLLRW	338 kW		09/01→			
24.480 FNLLC/N, FNLLW, FNLLRC, FNLLRW	353 kW		09/02→			
24.510 FNLLC/N, FNLLW, FNLLRW	375 kW		09/01→			
24.530 FNLLC/N, FNLLW, FNLLRW	390 kW		09/01→			
26.280 FNLC, FNLLC, FNLLW	206 kW		11/02→			
26.310, 26.320 FDC, FDRC, FDC/M, FDRC/M, FDLC, FNHLC, FVHLC	228 - 235 kW		05/04→			
26.310, 26.320 FDK, FDLK	228 - 235 kW		05/04→			
26.310, 26.320 FDS, FDS/M, FDLS, FDRS, FDRS/M, FNHLS, FDLRS	228 - 235 kW		05/04→			
26.310, 26.320 FNLC, FNLLC, FNLRC, FNLLRC, FNLLW	228 - 235 kW		05/04→			
26.310, 26.320 FNLS, FNLLS, FNLRS, FNLLRS	228 - 235 kW		05/04→			
26.310, 26.320 FVLC	228 - 235 kW		02/04→			
26.310, 26.320 FVL-KO	228 - 235 kW		02/04→			
26.310 FDAC	228 kW		01/04→			
26.310 FDAC, FDARC	228 kW		02/02→			
26.310 FDAK	228 kW		02/02→			
26.310 FDAK	228 kW		01/04→			
26.310 FDAS	228 kW		01/04→			
26.310 FDAS, FDARS	228 kW		02/02→			
26.310 FDC, FDLC, FDRC, FDLC/M, FDLRC	228 kW		01/01→			
26.310 FDK, FDLK, FDRK	228 kW		09/02→			
26.310 FDS, FDLS, FDLRS	228 kW		01/01→			
26.310 FD-TM, FDR-TM	228 kW		10/00→			
26.310 FNLC, FNLLC, FVLC, FNLLW, FNLRC, FNLLRW	228 kW		09/00→			
26.310 FPLS, FVLS, FNLS, FNLLS, FPLRS, FNLRS, FVLRS	228 kW		12/00→			
26.310 FVLC	228 kW		09/03→			
26.310 FVL-KO	228 kW		12/00→			
26.330 FNLC, FNLLC, FNLLW	240 kW		11/02→			
26.350, 26.360 FDC, FDRC, FDC/M, FDRC/M, FDLC, FDLRC, FNHLC	257 - 265 kW		05/04→			
26.350, 26.360 FDHS, FDHS/M, FDHLS	257 - 265 kW		05/04→			
26.350, 26.360 FDH-TM	257 - 265 kW		05/04→			
26.350, 26.360 FDK, FDLK, FDRK	257 - 265 kW		05/04→			
26.350, 26.360 FDS, FDS/M, FDLS, FDRS, FNHLS, FPHLS	257 - 265 kW		05/04→			
26.350, 26.360 FD-TM	257 - 265 kW		02/04→			
26.350, 26.360 FNLC, FNLLC, FNLLW, FNLRC, FNLLRC	257 - 265 kW		05/04→			
26.350, 26.360 FNLS, FNLLS, FNLRS, FNLLRS, FPLS, FPLRS	257 - 265 kW		05/04→			
26.350 FDAC	257 kW		02/04→			
26.350 FDAK	257 kW		02/04→			
26.350 FDAS	257 kW		02/04→			
26.350 FDLRC-WW	257 kW		05/04→			
26.350 FDLS, FDLRS, FDLRS/M, FDLRS-WW	257 kW		05/04→			
26.350 FVLC	257 kW		01/04→			
26.360 FDAC, FDARC	265 kW		02/02→			
26.360 FDAC, FDARC	265 kW		06/04→			
26.360 FDAK, FDALK	265 kW		02/02→			
26.360 FDAK, FDARK	265 kW		06/04→			
26.360 FDAS, FDARS	265 kW		02/02→			
26.360 FDAS, FDARS	265 kW		06/04→			
26.360 FDC, FDLC, FDLC/M, FDRC, FDLRC-WW	265 kW		01/01→			
26.360 FDHC, FDHLC	265 kW		05/04→			
26.360 FDK, FDLK, FDRK, FDLRK	265 kW		09/02→			
26.360 FDLC-WW, FDLRC	265 kW		05/04→			
26.360 FDLS, FDLRS-WW, FNHLS	265 kW		05/04→			
26.360 FDLS, FDLS/M, FDLRS, FDLRS/M, FDLRS-WW, FDRS	265 kW		09/03→			

Manufacturer - Model	Power	Displ.	Year of Constr.	Remark	Part Number	Page
MAN - TGA						04/00→
26.360 FDS, FDLS, FNLS, FNLLS, FPLS, FPLRS, FVLS, FVLR	265 kW		12/00→			
26.360 FD-TM, FDR-TM	265 kW		01/01→			
26.360 FNLC, FNLLC, FNLLW, FNLLRC, FNLLRW, FVLC	265 kW		09/00→			
26.360 FVL-KO	265 kW		12/00→			
26.390, 26.400 FDC, FDRC, FDLRC, FDRC/M, FDLC, FNHLC, FVHLC	287 - 294 kW		05/04→			
26.390, 26.400 FDK, FDLK	287 - 294 kW		05/04→			
26.390, 26.400 FDS, FDS/M, FDL, FDLRS, FNHLS, FPHLS, FVHLS	287 - 294 kW		05/04→			
26.390, 26.400 FD-TM	287 - 294 kW		05/04→			
26.390, 26.400 FNLC, FNLLC, FNLLW, FNLR, FNLLRC	287 - 294 kW		05/04→			
26.390, 26.400 FNLS, FNLLS, FNLR, FNLLRS, FPLS, FPLRS	287 - 294 kW		05/04→			
26.390, 26.400 FVL-KO	287 - 294 kW		02/04→			
26.390 FDAC, FDALC	287 kW		01/04→			
26.390 FDAK, FDALK	287 kW		02/04→			
26.390 FDAS, FDALS	287 kW		02/04→			
26.390 FVLC	287 kW		02/04→			
26.400 FDAC, FDALC	294 kW		01/04→			
26.400 FDAK, FDALK	294 kW		01/04→			
26.400 FDAS, FDALS	294 kW		01/04→			
26.410 FDAC, FDARC	301 kW		02/02→			
26.410 FDAK, FDALK	301 kW		02/02→			
26.410 FDAS, FDALS, FDARS	301 kW		02/02→			
26.410 FDC, FDLC, FDLC/M, FDLC-WW; FDRC-WW, FDLRC-WW	301 kW		01/01→			
26.410 FDK, FDRK, FDLK, FDLRK	301 kW		09/01→			
26.410 FDS, FDLS, FDLS/M, FDLS-WW, FDRS-WW, FDLRS-WW	301 kW		06/01→			
26.410 FD-TM, FDR-TM	301 kW		01/01→			
26.410 FNLC, FNLLC, FNLLW, FNLR, FNLLRC, FVLC	301 kW		04/00→			
26.410 FPLS, FPLRS, FVLS, FNLS, FNLLS	301 kW		12/00→			
26.410 FVLC	301 kW		09/03→			
26.410 FVL-KO	301 kW		12/00→			
26.430, 26.440, FNLC, FNLLC, FNLLW, FNLR, FNLLRC, FVLC	316 - 324 kW		05/04→			
26.430, 26.440, FNLS, FNLLS, FNLR, FNLLRS, FPLS, FPLRS	316 - 324 kW		05/04→			
26.430, 26.440 FDC, FDRC, FDLC, FDLRC, FDLC/M, FNHLC, FVHLC	316 - 324 kW		05/04→			
26.430, 26.440 FDK, FDLK	316 - 324 kW		05/04→			
26.430, 26.440 FDS, FDLS, FDRS, FDLRS, FNHLS, FPHLS, FVHLS	316 - 324 kW		02/04→			
26.430, 26.440 FD-TM	316 - 324 kW		05/04→			
26.430 FDAC, FDALC	316 kW		01/04→			
26.430 FDAK, FDALK	316 kW		01/04→			
26.430 FDAS, FDALS	316 kW		01/04→			
26.430 FDLS, FDLS/M, FDLRS-WW	316 - 324 kW		02/04→			
26.430 FVL-KO	316 kW		12/00→			
26.440 FDAK, FDALK	324 kW		01/04→			
26.440 FDAS, FDALS	324 kW		01/04→			
26.460 FDC, FDLC, FDLC/M, FDLC-WW, FDRC, FDLRC-WW	338 kW		01/01→			
26.460 FDK, FDLK, FDLRK	338 kW		01/01→			
26.460 FDS, FDLS, FDLS/M, FDLS-WW, FDRS-WW, FDLRS-WW	338 kW		06/01→			
26.460 FD-TM, FDR-TM	338 kW		01/01→			
26.460 FNLC, FNLR, FNLLC, FNLLRW, FNLLRC	338 kW		04/00→			
26.460 FPLS, FPLRS, FVLS, FVLR, FNLS, FNLLS, FNLR	338 kW		12/00→			
26.460 FVLC	338 kW		02/01→			
26.460 FVL-KO	338 kW		12/00→			
26.480 FDAC, FDALC, FDARC	353 kW		09/02→			
26.480 FDAK, FDALK	353 kW		09/02→			
26.480 FDAS, FDALS, FDARS	353 kW		09/02→			

Manufacturer - Model	Power	Displ.	Year of Constr.	Remark	Part Number	Page
MAN - TGA						04/00→
26.480 FDC, FDLC, FDRC, FDLC/M, FDLRC-WW	353 kW		09/02→			
26.480 FDK, FDLK, FDLRK	353 kW		09/02→			
26.480 FDS, FDLS, FDLS/M, FDLRS-WW, FDRS	353 kW		09/02→			
26.480 FD-TM	353 kW		09/02→			
26.480 FNLC, FNLLC, FVLC, FNLLRC, FVLLW	353 kW		09/02→			
26.480 FNLS, FNLLS, FNLRS, FPLS, FVLS	353 kW		09/02→			
26.480 FVL-KO	353 kW		09/02→			
26.510 FDC, FDC/M, FDRC, FDLC, FDLC/M, FDLRC	375 kW		01/01→			
26.510 FDS, FDLS, FDLS/M, FDRS, FDLRS	375 kW		01/01→			
26.510 FNLC, FNLLC, FNLLW, FNLLRC, FVLC	375 kW		12/00→			
26.510 FNLS, FNLLS, FNLRS, FPLS, FVLS	375 kW		12/00→			
26.530 FDAK, FDALK	390 kW		09/02→			
26.530 FDC, FDLC, FDC/M, FDLRC	390 kW		01/01→			
26.530 FDK, FDLK, FDLRK	390 kW		09/02→			
26.530 FDS, FDLS, FDLS/M, FDLRS	390 kW		01/01→			
26.530 FNLC, FNLLC, FNLLW, FNLLRC, FVLC, FVLR	390 kW		09/02→			
26.530 FNLS, FNLLS, FNLRS, FPLS, FVLS, FVLR	390 kW		09/02→			
28.310 FNLC, FNLLC	228 kW		09/02→			
28.310 FNLC, FNLLC, FNLRC	228 kW		09/02→			
28.310 FNLS, FNLRS	228 kW		09/02→			
28.310 FNLS, FNLRS	228 kW		06/04→			
28.320 FNLC, FNLLC, FNLRC	235 kW		06/04→			
28.320 FNLS, FNLRS	235 kW		06/04→			
28.350, 28.360 FNLC, FNLLC, FNLRC, FNLL-LE	257 - 265 kW		06/04→			
28.350 FNLS, FNLRS-WW	257 kW		02/04→			
28.360 FNLC, FNLLC	265 kW		09/02→			
28.360 FNLS, FNLRS	265 kW		09/02→			
28.390, 28.400 FNLC, FNLLC, FNLRC-WW	287 - 294 kW		06/04→			
28.390 FNLS, FNLRS	287 kW		05/04→			
28.410 FNLC, FNLLC	301 kW		09/02→			
28.410 FNLC, FNLLC, FNLRC	301 kW		09/02→			
28.410 FNLS, FNLRS	301 kW		09/02→			
28.430, 28.440 FNLC, FNLLC, FNLRC-WW	316 - 324 kW		06/04→			
28.430 FNLS, FNLRS-WW	316 kW		05/04→			
28.460 FNLC, FNLLC, FNLRC	338 kW		09/02→			
28.460 FNLS, FNLRS	338 kW		09/02→			
28.480 FNLC, FNLLC, FNLRC	353 kW		09/02→			
28.480 FNLS, FNLRS	353 kW		09/02→			
28.510 FNLC, FNLLC, FNLRC	375 kW		09/02→			
28.510 FNLS, FNLRS	375 kW		09/02→			
28.530 FNLC, FNLLC, FNLRC	390 kW		09/02→			
28.530 FNLS, FNLRS	390 kW		09/02→			
32.310 FFDK, FFDLC, FFDLRC	228 kW		01/02→			
32.310 FFDK, FFDLK	228 kW		01/02→			
32.310 FFD-TM	228 kW		01/02→			
32.350, 32.360 FFDRC	257 - 265 kW		05/04→			
32.350, 32.360 FFD-TM, FFDRTM	257 - 265 kW		02/04→			
32.360 FFDK, FFDLC, FFDLRC	265 kW		01/02→			
32.360 FFDK, FFDLK	265 kW		01/02→			
32.360 FFD-TM	265 kW		01/02→			
32.390, 32.400 FFDRC	287 - 294 kW		05/04→			
32.390, 32.400 FFD-TM, FFDRTM	287 - 294 kW		05/04→			
32.410 FFDK, FFDLC, FFDRC, FFDLRC	301 kW		01/02→			
32.410 FFDK, FFDLK	301 kW		01/02→			
32.410 FFD-TM	301 kW		01/02→			
32.430, 32.440 FFDRC	316 - 324 kW		05/04→			
32.430, 32.440 FFD-TM, FFDRTM	316 - 324 kW		05/04→			
32.460 FFDK, FFDLC, FFDLRC	338 kW		01/02→			
32.460 FFDK, FFDLK	338 kW		01/02→			
32.460 FFD-TM	338 kW		01/02→			
32.480 FFDK, FFDLC, FFDLRC	353 kW		09/02→			
32.480 FFDK, FFDLK	353 kW		09/02→			

Manufacturer - Model	Power	Displ.	Year of Constr.	Remark	Part Number	Page
MAN - TGA						04/00→
32.480 FFD-TM	353 kW		09/02→			
33.350, 33.360 FDC, FDC/M, FDLC, FDRC	257 - 265 kW		05/04→			
33.350, 33.360 FDK, FDLK, FDRK	257 - 265 kW		05/04→			
33.350, 33.360 FDS, FDLS, FDS/M, FDRS	257 - 265 kW		05/04→			
33.360 FDAC, FDARC, FDAC-WW	265 kW		09/02→			
33.360 FDAK, FDAK-WW	265 kW		09/02→			
33.360 FDAS, FDAS-WW	265 kW		09/02→			
33.360 FDC, FDC-WW, FDLC/M, FDRC-WW, FDLRC	265 kW		10/00→			
33.360 FDK, FDK-WW, FDLK, FDRK-WW	265 kW		01/01→			
33.360 FDS, FDS-WW, FDLS, FDLRS, FDRS-WW	265 kW		10/00→			
33.360 FD-TM, FDR-TM	265 kW		01/01→			
33.390, 33.400 FDC, FDLC, FDRC, FDC/M	287 - 294 kW		05/04→			
33.390, 33.400 FDK, FDLK, FDRK	287 - 294 kW		05/04→			
33.390, 33.400 FDS, FDLS, FDLRS, FDRS, FDS/M	287 - 294 kW		05/04→			
33.410 FDAC, FDAC-WW, FDALC	301 kW		09/02→			
33.410 FDAK, FDAK-WW, FDALK	301 kW		09/02→			
33.410 FDAS, FDAS-WW, FDALS	301 kW		09/02→			
33.410 FDC, FDC-WW, FDLC, FDLRC, FDRC-WW	301 kW		10/00→			
33.410 FDK, FDK-WW, FDLK, FDRK-WW	301 kW		10/00→			
33.410 FDS, FDS-WW, FDLS, FDLS/M, FDLRS, FDRS-WW	301 kW		10/00→			
33.410 FD-TM, FDR-TM	301 kW		10/00→			
33.430, 33.440 FDC, FDLC, FDRC, FDLRC, FDC/M	316 - 324 kW		05/04→			
33.430, 33.440 FDK, FDLK, FDRK	316 - 324 kW		05/04→			
33.430, 33.440 FDS, FDLS, FDRS, FDLRS, FDS/M	316 - 324 kW		05/04→			
33.460 FDAC-WW	338 kW		09/02→			
33.460 FDAK-WW	338 kW		09/02→			
33.460 FDAS-WW	338 kW		09/02→			
33.460 FDC, FDC-WW, FDLC, FDLRC, FDRC-WW	338 kW		09/02→			
33.460 FDK, FDK-WW, FDLK, FDRK-WW	338 kW		09/02→			
33.460 FDS, FDLS, FDLS/M, FDLRS, FDRS-WW	338 kW		09/02→			
33.460 FD-TM, FDR-TM	338 kW		09/02→			
33.480 FDAC, FDAC-WW, FDALC, FDARC	353 kW		09/02→			
33.480 FDAK, FDAK-WW, FDALK	353 kW		09/02→			
33.480 FDAS, FDAS-WW, FDARS, FDALS	353 kW		09/02→			
33.480 FDC, FDC-WW, FDLC, FDRC-WW, FDLRC	353 kW		09/02→			
33.480 FDK, FDK-WW, FDLK, FDRK-WW	353 kW		09/02→			
33.480 FDS, FDS-WW, FDLS, FDLS/M, FDRS-WW, FDLRS	353 kW		09/02→			
33.480 FD-TM	353 kW		09/02→			
33.510 FDC, FDC/M, FDLC, FDRC, FDLRC	375 kW		09/02→			
33.510 FDS, FDLS/M, FDRS, FDLRS/M	375 kW		09/02→			
33.530 FDAC, FDALC	390 kW		09/02→			
33.530 FDAK, FDALK	390 kW		09/02→			
33.530 FDAS, FDALS	390 kW		09/02→			
33.530 FDC, FDC/M, FDLC, FDRC, FDLRC	390 kW		09/02→			
33.530 FDK, FDLK	390 kW		07/03→			
33.530 FDS, FDLS, FDLS/M, FDRS, FDLRS	390 kW		07/03→			
35.310, 35.320 FFDC, FFDC	228 - 235 kW		02/04→			
35.310, 35.320 FFDK, FFDLK	228 - 235 kW		02/04→			
35.310, 35.320 FFD-TM	228 - 235 kW		02/04→			

Manufacturer - Model	Power	Displ.	Year of Constr.	Remark	Part Number	Page
MAN - TGA						04/00→
35.310 FFDC, FFDLC	228 kW		06/03→			
35.310 FFDK, FFDLK	228 kW		06/03→			
35.310 FFD-TM	228 kW		11/03→			
35.350, 35.360 FFDC, FFDRC, FFDLC	257 - 265 kW		02/04→			
35.350, 35.360 FFDK, FFDRC, FFDLC	257 - 265 kW		02/04→			
35.350, 35.360 FFD-TM	257 - 265 kW		02/04→			
35.360 FFDC, FFDLC	265 kW		10/03→			
35.360 FFDK, FFDLK	265 kW		10/03→			
35.360 FFD-TM	265 kW		11/03→			
35.390, 35.400 FFDC, FFDRC, FFDLC	287 - 294 kW		02/04→			
35.390, 35.400 FFDK, FFDRC, FFDLC	287 - 294 kW		02/04→			
35.390, 35.400 FFD-TM	287 - 294 kW		02/04→			
35.390 FFDK	287 kW		02/04→			
35.400 FFDK	294 kW		02/04→			
35.410 FFDC, FFDLC	301 kW		10/03→			
35.410 FFDK, FFDLK	301 kW		10/03→			
35.410 FFD-TM	301 kW		11/03→			
35.430, 35.440 FFDC, FFDRC, FFDLC	316 - 324 kW		02/04→			
35.430, 35.440 FFDK, FFDRC, FFDLC	316 - 324 kW		02/04→			
35.430, 35.440 FFD-TM	316 - 324 kW		02/04→			
35.460 FFDC, FFDLC	338 kW		10/03→			
35.460 FFDK, FFDLK	338 kW		10/03→			
35.460 FFD-TM	338 kW		11/03→			
35.480 FFDC, FFDLC	353 kW		10/03→			
35.480 FFDC, FFDLC	353 kW		02/04→			
35.480 FFDK, FFDLK	353 kW		10/03→			
35.480 FFDK, FFDLK	353 kW		02/04→			
35.480 FFD-TM	353 kW		11/03→			
35.480 FFD-TM	353 kW		02/04→			
35.530 FDNLC	390 kW		04/04→			
35.530 FFDC, FFDLC	390 kW		04/04→			
35.530 FFDK, FFDLK	390 kW		04/04→			
35.530 FFD-TM	390 kW		04/04→			
37.310, 37.320 FFDC	228 - 235 kW		12/04→			
37.310, 37.320 FFDK	228 - 235 kW		12/04→			
37.310, 37.320 FFD-TM	228 - 235 kW		12/04→			
37.310 FFDC	228 kW		12/04→			
37.310 FFDK	228 kW		12/04→			
37.310 FFD-TM	228 kW		12/04→			
37.350, 37.360 FFDC	257 - 265 kW		12/04→			
37.350, 37.360 FFDK	257 - 265 kW		12/04→			
37.350, 37.360 FFD-TM	257 - 265 kW		12/04→			
37.360 FFDC	265 kW		12/04→			
37.360 FFDK	265 kW		12/04→			
37.360 FFD-TM	265 kW		12/04→			
37.390, 37.400 FFDC	287 - 294 kW		12/04→			
37.390, 37.400 FFDK	287 - 294 kW		12/04→			
37.390, 37.400 FFD-TM	287 - 294 kW		12/04→			
37.410 FFDC	301 kW		12/04→			
37.410 FFDK	301 kW		12/04→			
37.410 FFD-TM	301 kW		12/04→			
37.430, 37.440 FFDC	316 - 324 kW		12/04→			
37.430, 37.440 FFDK	316 - 324 kW		12/04→			
37.430, 37.440 FFD-TM	316 - 324 kW		12/04→			
37.460 FFDC	338 kW		12/04→			
37.460 FFDK	338 kW		12/04→			
37.460 FFD-TM	338 kW		12/04→			
37.480 FFDC	353 kW		12/04→			
37.480 FFDK	353 kW		12/04→			
37.480 FFD-TM	353 kW		12/04→			
37.530 FFDC	390 kW		12/04→			
37.530 FFDK	390 kW		12/04→			
37.530 FFD-TM	390 kW		12/04→			
40.410 FDK-WW	301 kW		04/04→			
40.410 FDAS-WW	301 kW		04/04→			
40.410 FDK-WW	301 kW		04/04→			
40.410 FDS-WW	301 kW		04/04→			
40.460 FDK-WW	338 kW		04/04→			
40.460 FDAS-WW	338 kW		04/04→			
40.460 FDK-WW	338 kW		04/04→			
40.460 FDS-WW	338 kW		04/04→			
40.480 FDK-WW	353 kW		04/04→			
40.480 FDAS-WW	353 kW		04/04→			
40.480 FDK-WW	353 kW		04/04→			
40.480 FDS-WW	353 kW		04/04→			

Manufacturer - Model	Power	Displ.	Year of Constr.	Remark	Part Number	Page
MAN - TGA						04/00→
41.350, 41.360 FFDC, FFDC/M, FFDRK	257 - 265 kW		12/04→			
41.350, 41.360 FFDK, FFDRK	257 - 265 kW		12/04→			
41.350, 41.360 FFD-TM	257 - 265 kW		12/04→			
41.360 FFDC, FFDC/M, FFDC/M-WW, FFDRK	265 kW		01/03→			
41.360 FFDK-WW	265 kW		09/03→			
41.360 FFD-TM	265 kW		12/04→			
41.390, 41.400 FFDC, FFDRK, FFDC/M	287 - 294 kW		12/04→			
41.390, 41.400 FFDK, FFDRK	287 - 294 kW		12/04→			
41.390, 41.400 FFD-TM	287 - 294 kW		12/04→			
41.390 FFDK	287 kW		12/04→			
41.410 FFDC-WW, FDRC	301 kW		09/03→			
41.410 FFDK-WW	301 kW		09/03→			
41.410 FFD-TM	301 kW		12/04→			
41.430, 41.440 FFDC, FFDRK, FFDC/M	316 - 324 kW		12/04→			
41.430, 41.440 FFDK, FFDRK	316 - 324 kW		12/04→			
41.430, 41.440 FFD-TM	316 - 324 kW		12/04→			
41.430 FFDK	316 kW		12/04→			
41.440 FFD/M	324 kW		12/04→			
41.440 FFDC, FFDRK	324 kW		12/04→			
41.440 FFDK, FFDRK	324 kW		12/04→			
41.460 FFDC-WW, FFDRK	338 kW		09/03→			
41.460 FFDK-WW	338 kW		09/03→			
41.460 FFD-TM	338 kW		12/04→			
41.480 FFD-TM	353 kW		12/04→			
41.530 FFDC	390 kW		12/04→			
41.530 FFDK	390 kW		12/04→			
41.530 FFD-TM	390 kW		12/04→			
41.530 FVDS, FVDLS	390 kW		09/02→			
41.660 FVDS, FVDLS	485 kW		09/02→			
18.360 FLS, FLLS, FLRS, FLLRS	265 kW		01/06→	W5W / H7 / H7; Left; Number of light functions: 3; with bulbs; for vehicles without headlamp levelling	1EH 354 984-011 Headlight	16
18.400 FLS, FLLS, FLRS, FLLRS	294 kW		10/05→			
18.440 FLS, FLLS, FLRS, FLLRS	324 kW		09/05→			
18.480 FAC	353 kW		02/06→	W5W / H7 / H7; Right; Number of light functions: 3; with bulbs; for vehicles without headlamp levelling	1EH 354 984-021 Headlight	16
18.480 FAK, FALK	353 kW		02/06→			
18.480 FAS, FALS	353 kW		02/06→			
18.480 FC, FLC, FLLC, FLLRC, FLLW, FLRC	353 kW		01/06→	W5W / H7 / H7; Left; Number of light functions: 3; with bulbs; for vehicles with headlamp levelling (electric)	1EH 354 984-031 Headlight	17
18.480 FHLC	353 kW		04/06→			
18.480 FHLK, FHLK/M	353 kW		04/06→	W5W / H7 / H7; Right; Number of light functions: 3; with bulbs; for vehicles with headlamp levelling (electric)	1EH 354 984-041 Headlight	17
18.480 FHLS, FHLS/M	353 kW		04/06→			
18.480 FK, FK-L, FLK	353 kW		01/06→			
18.480 FLS, FLLS, FLRS, FLLRS	353 kW		01/06→	P21W / H4; Left; Yellow; with indicator / with high beam / with fog light; Number of light functions: 3; with bulbs	1NB 354 986-031 Spotlight	5, 23
18.540 FLC, FLRC, FLLC, FLLRC, FLLW	397 kW		08/06→			
18.540 FLS, FLRS, FLLS, FLLRS	397 kW		02/06→	P21W / H4; Left; Yellow; with indicator / with high beam / with fog light; Number of light functions: 3; with bulbs	1NB 354 986-031 Fog Light	5, 23
19.440 FRS, FS/M-WW, FLS, FLRS	324 kW		02/06→			
19.480 FLS, FRS, FLRS-WW	353 kW		02/06→	P21W / H4; Right; Yellow; with indicator / with high beam / with fog light; Number of light functions: 3; with bulbs	1NB 354 986-041 Spotlight	6, 24
19.480 FS/M, FRS/M-WW	353 kW		02/06→			
24.480 FNLLC/N, FNLLW/N	353 kW		01/06→	P21W / H4; Right; Yellow; with indicator / with high beam / with fog light; Number of light functions: 3; with bulbs	1NB 354 986-041 Fog Light	6, 24
24.480 FPLS, FPLRS	353 kW		07/05→			
24.480 FPLS, FPLRS	353 kW		01/06→			
24.530 FPLS, FPLRS	390 kW		07/05→	H4 / PY21W; Left; White; with indicator / with high beam / with fog light; Number of light functions: 3; with bulbs	1NB 354 986-051 Spotlight	6, 24
24.540 FNLLC/N, FLLCW/N	397 kW		01/06→			
26.310, 26.320 FDH, FDHC, FDHC/M	228 - 235 kW		06/05→			
26.310, 26.320 FDHK	228 - 235 kW		06/05→	H4 / PY21W; Left; White; with indicator / with high beam / with fog light; Number of light functions: 3; with bulbs	1NB 354 986-051 Fog Light	6, 24
26.310, 26.320 FDHS, FDHS/M	228 - 235 kW		06/05→			
26.310, 26.320 FDH-TM	228 - 235 kW		06/05→	H4 / PY21W; Right; White; with indicator / with high beam / with fog light; Number of light functions: 3; with bulbs	1NB 354 986-061 Spotlight	6, 24
26.310, 26.320 FD-TM	228 - 235 kW		06/05→			
26.310, 26.320 FVHL-KO	228 - 235 kW		06/05→			
26.320 FDAC	235 kW		04/06→	H4 / PY21W; Right; White; with indicator / with high beam / with fog light; Number of light functions: 3; with bulbs	1NB 354 986-061 Fog Light	6, 24
26.320 FDAK	235 kW		04/06→			
26.320 FDAS	235 kW		04/06→			
26.350, 26.360 FVHL-KO	257 - 265 kW		06/05→			
26.350, 26.360 FVL-KO	257 - 265 kW		01/04→			
26.350 FVHLC	257 kW		06/05→			
26.350 FVHLS	257 kW		07/05→			
26.350 FVLS, FVLR	257 kW		07/05→			
26.360 FVHLC	265 kW		04/06→			
26.360 FVHLS	265 kW		04/06→			
26.360 FVLC	265 kW		04/06→			
26.360 FVLS, FVLR	265 kW		04/06→			
26.390, 26.400 FDHC, FDHC/M, FDHLC	287 - 294 kW		06/05→			
26.390, 26.400 FDHK, FDHLK	287 - 294 kW		06/05→			
				Left; without gasket / seal	9ES 354 984-051 Diffusing Lens, headlight	4
				Right; without gasket / seal	9ES 354 984-061 Diffusing Lens, headlight	4

Manufacturer - Model	Power	Displ.	Year of Constr.	Remark	Part Number	Page
MAN - TGA						04/00→
26.390, 26.400 FDHS, FDHS/M, FDHLS	287 - 294 kW		06/05→	W5W / H7 / H7; Left; Number of light functions: 3; with bulbs; for vehicles without headlamp levelling	1EH 354 984-011 Headlight	16
26.390, 26.400 FVHL-KO	287 - 294 kW		06/05→			
26.390 FDH-TM	287 kW		06/05→	W5W / H7 / H7; Right; Number of light functions: 3; with bulbs; for vehicles without headlamp levelling	1EH 354 984-021 Headlight	16
26.390 FVLS, FVLR	287 kW		07/05→			
26.400 FDH-TM	294 kW		04/06→			
26.400 FVLC	294 kW		04/06→	W5W / H7 / H7; Left; Number of light functions: 3; with bulbs; for vehicles with headlamp levelling (electric)	1EH 354 984-031 Headlight	17
26.400 FVLS, FVLR	294 kW		04/06→			
26.410 FVLS, FVLR	301 kW		07/05→			
26.430, 26.440 FDHC, FDHC/M, FDHLC	316 - 324 kW		06/05→	W5W / H7 / H7; Right; Number of light functions: 3; with bulbs; for vehicles with headlamp levelling (electric)	1EH 354 984-041 Headlight	17
26.430, 26.440 FDHK, FDHLK	316 - 324 kW		06/05→			
26.430, 26.440 FDHS, FDHS/M, FDHLS	316 - 324 kW		06/05→	P21W / H4; Left; Yellow; with indicator / with high beam / with fog light; Number of light functions: 3; with bulbs	1NB 354 986-031 Spotlight	5, 23
26.430, 26.440 FDH-TM	316 - 324 kW		06/05→			
26.430, 26.440 FVLH-KO	316 - 324 kW		06/05→	P21W / H4; Left; Yellow; with indicator / with high beam / with fog light; Number of light functions: 3; with bulbs	1NB 354 986-031 Fog Light	5, 23
26.430 FVLS, FVLR	316 kW		07/05→			
26.440 FDAC, FDALC	324 kW		09/05→	P21W / H4; Right; Yellow; with indicator / with high beam / with fog light; Number of light functions: 3; with bulbs	1NB 354 986-041 Spotlight	6, 24
26.440 FDLC-WW, FDLRC-WW	324 kW		02/06→			
26.440 FDS, FDL, FDL-WW, FDLRS-WW	324 kW		02/06→			
26.440 FVL-KO	324 kW		09/05→	P21W / H4; Right; Yellow; with indicator / with high beam / with fog light; Number of light functions: 3; with bulbs	1NB 354 986-041 Fog Light	6, 24
26.440 FVLS, FVLR	324 kW		09/05→			
26.480 FDAC, FDALC	353 kW		02/06→	H4 / PY21W; Left; White; with indicator / with high beam / with fog light; Number of light functions: 3; with bulbs	1NB 354 986-051 Spotlight	6, 24
26.480 FDAK, FDALK	353 kW		02/06→			
26.480 FDAS, FDALS	353 kW		02/06→			
26.480 FDC, FDC/M, FDLC, FDLRC, FDRC, FNHLC, FVHLC, FDLRC-WW	353 kW		02/06→	H4 / PY21W; Left; White; with indicator / with high beam / with fog light; Number of light functions: 3; with bulbs	1NB 354 986-051 Fog Light	6, 24
26.480 FDHC, FDHC/M, FDHLC	353 kW		02/06→			
26.480 FDHK, FDHLK	353 kW		02/06→	H4 / PY21W; Right; White; with indicator / with high beam / with fog light; Number of light functions: 3; with bulbs	1NB 354 986-061 Spotlight	6, 24
26.480 FDHS, FDHS/M, FDHLS	353 kW		02/06→			
26.480 FDH-TM	353 kW		02/06→	H4 / PY21W; Right; White; with indicator / with high beam / with fog light; Number of light functions: 3; with bulbs	1NB 354 986-061 Fog Light	6, 24
26.480 FDK, FDLK	353 kW		02/06→			
26.480 FDS, FDL, FDLRS, FNHLS, FPHLS, FVHLS	353 kW		02/06→	P21W; Left / Right; Number of light functions: 1; with lamp base	2KA 003 389-081 Licence Plate Light	44
26.480 FD-TM	353 kW		02/06→			
26.480 FNLC, FNLC-WW, FNLLC, FNLLRC, FNLLW, FVLC	353 kW		02/06→	Front; White; Number of light functions: 1	2PF 354 985-011 Position Light	45
26.480 FNLS, FNLS, FNLR, FNLR, FNLR, FNLR	353 kW		02/06→	Yellow; LED; Number of light functions: 1	2PS 354 985-001 Side Marker Light	45
26.480 FVHL-KO	353 kW		02/06→	R10W; without lamp base; with screw	9BG 121 587-031 Housing, licence plate light	27
26.480 FVLC	353 kW		01/06→			
26.530 FDAC, FDALC	390 kW		07/06→	Left; without gasket / seal	9ES 354 984-051 Diffusing Lens, headlight	4
26.530 FDAS, FDALS	390 kW		07/06→			
26.540 FNLC, FNLLC, FNLLRC, FNLLW	397 kW		08/06→	Right; without gasket / seal	9ES 354 984-061 Diffusing Lens, headlight	4
27.440 FDS, FDL, FDLRS, FDLRS	324 kW		10/08→			
28.310, 28.320 FNLC, FNLLC, FNLL-LE, FNLLR-LE	228 - 235 kW		07/06→			
28.310, 28.320 FNLC, FNLLC, FNLLRC, FNLLR-LE	228 - 235 kW		07/06→			
28.350, 28.360 FNLC, FNLLC, FNLL-LE	257 - 265 kW		07/06→			
28.350 FANLC	257 kW		07/06→			
28.350 FANLK	257 kW		07/06→			
28.360 FANLC	265 kW		07/06→			
28.360 FANLK	265 kW		07/06→			
28.360 FNLS, FNLR, FNLR, FNLR	265 kW		04/06→			
28.390 FANLC	287 kW		07/06→			
28.390 FANLK	287 kW		07/06→			
28.390 FNLLC	353 kW		07/06→			
28.400 FANLC	294 kW		07/06→			
28.400 FANLK	294 kW		07/06→			
28.400 FNLS, FNLR	294 kW		04/06→			
28.410 FANLC	301 kW		07/06→			
28.410 FANLK	301 kW		07/06→			
28.430 FANLC	316 kW		07/06→			
28.430 FANLK	316 kW		07/06→			
28.440 FANLC	324 kW		07/06→			
28.440 FANLK	324 kW		07/06→			
28.440 FNLS, FNLR, FNLR, FNLR	324 kW		09/05→			
28.480 FANLC	353 kW		07/06→			
28.480 FANLK	353 kW		07/06→			
28.480 FNLC, FNLC-WW, FNLLC	353 kW		02/06→			
28.480 FNLS, FNLR, FNLR, FNLR	353 kW		02/06→			
28.530 FANLC	390 kW		07/06→			
28.530 FANLK	390 kW		07/06→			
28.540 FNLC, FNLLC	397 kW		08/06→			

Manufacturer - Model	Power	Displ.	Year of Constr.	Remark	Part Number	Page
MAN - TGA						04/00→
28.540 FNLS	397 kW		08/06→	W5W / H7 / H7; Left; Number of light functions: 3; with bulbs; for vehicles without headlamp levelling	1EH 354 984-011 Headlight	16
32.480 FFDR	353 kW		02/06→			
32.480 FFD-TM, FFDR-TM	353 kW		02/06→			
33.350, 33.360 FDAC, FDHC, FDHC/M	257 - 265 kW		06/05→	W5W / H7 / H7; Right; Number of light functions: 3; with bulbs; for vehicles without headlamp levelling	1EH 354 984-021 Headlight	16
33.350, 33.360 FDAK, FDHK	257 - 265 kW		06/05→			
33.350, 33.360 FDAS, FDHS, FDHS/M	257 - 265 kW		06/05→	W5W / H7 / H7; Left; Number of light functions: 3; with bulbs; for vehicles with headlamp levelling (electric)	1EH 354 984-031 Headlight	17
33.350 FDC-TM, FDRC-TM	257 kW		09/07→			
33.360 FDC-TM, FDRC-TM	265 kW		09/07→			
33.390, 33.400 FDAC, FDHC, FDHC/M	287 - 295 kW		06/05→	W5W / H7 / H7; Right; Number of light functions: 3; with bulbs; for vehicles with headlamp levelling (electric)	1EH 354 984-041 Headlight	17
33.390, 33.400 FDAK, FDHK	287 - 295 kW		06/05→			
33.390, 33.400 FDAS, FDHS, FDHS/M	287 - 295 kW		06/05→	P21W / H4; Left; Yellow; with indicator / with high beam / with fog light; Number of light functions: 3; with bulbs	1NB 354 986-031 Spotlight	5, 23
33.390, 33.400 FDC-TM, FDRC-TM	287 - 294 kW		09/07→	P21W / H4; Left; Yellow; with indicator / with high beam / with fog light; Number of light functions: 3; with bulbs	1NB 354 986-031 Fog Light	5, 23
33.430, 33.440 FDAC, FDALC, FDHC, FDHC/M	316 - 324 kW		06/05→	P21W / H4; Right; Yellow; with indicator / with high beam / with fog light; Number of light functions: 3; with bulbs	1NB 354 986-041 Spotlight	6, 24
33.430, 33.440 FDAK, FDALK, FDHK	316 - 324 kW		06/05→			
33.430, 33.440 FDAS, FDALS, FDHS	316 - 324 kW		06/05→	P21W / H4; Right; Yellow; with indicator / with high beam / with fog light; Number of light functions: 3; with bulbs	1NB 354 986-041 Fog Light	6, 24
33.440 FDAC, FDHC	324 kW		06/05→	H4 / PY21W; Left; White; with indicator / with high beam / with fog light; Number of light functions: 3; with bulbs	1NB 354 986-051 Spotlight	6, 24
33.440 FDAK, FDHK	324 kW		06/05→			
33.440 FDAS, FDHS	324 kW		06/05→			
33.440 FDC, FDRC	324 kW		06/05→	H4 / PY21W; Left; White; with indicator / with high beam / with fog light; Number of light functions: 3; with bulbs	1NB 354 986-051 Fog Light	6, 24
33.440 FDC-TM, FDRC-TM	324 kW		09/07→			
33.440 FDK, FDRK	324 kW		06/05→			
33.440 FDS, FDRS	324 kW		06/05→	H4 / PY21W; Right; White; with indicator / with high beam / with fog light; Number of light functions: 3; with bulbs	1NB 354 986-061 Spotlight	6, 24
33.480 FDAC, FDALC, FDHC, FDHC/M	353 kW		02/06→	H4 / PY21W; Right; White; with indicator / with high beam / with fog light; Number of light functions: 3; with bulbs	1NB 354 986-061 Fog Light	6, 24
33.480 FDAK, FDALK, FDHK	353 kW		02/06→			
33.480 FDAS, FDALS, FDHS	353 kW		02/06→			
33.480 FDC, FDLC, FDRC, FDC/M	353 kW		01/06→	P21W; Left / Right; Number of light functions: 1; with lamp base	2KA 003 389-081 Licence Plate Light	44
33.480 FDC-TM, FDRC-TM	353 kW		09/07→	Front; White; Number of light functions: 1	2PF 354 985-011 Position Light	45
33.480 FDK, FDLK, FDRK	353 kW		01/06→			
33.480 FDS, FDRS, FDLS, FDS/M	353 kW		01/06→	Yellow; LED; Number of light functions: 1	2PS 354 985-001 Side Marker Light	45
35.350 FFDHK, FFDHLK	257 kW		07/06→	R10W; without lamp base; with screw	9BG 121 587-031 Housing, licence plate light	27
35.350 FFDH-TM	257 kW		07/06→			
35.350 FFNLC	257 kW		07/06→			
35.360 FFDHK, FFDHLK	265 kW		07/06→			
35.360 FFDH-TM	265 kW		07/06→	Left; without gasket / seal	9ES 354 984-051 Diffusing Lens, headlight	4
35.360 FFNHLC	265 kW		07/06→			
35.360 FFNLC	265 kW		07/06→	Right; without gasket / seal	9ES 354 984-061 Diffusing Lens, headlight	4
35.390 FDNLC	287 kW		07/06→			
35.390 FFDAK, FFDHK, FFDHLK	287 kW		07/06→			
35.390 FFDH-TM	287 kW		07/06→			
35.390 FFNLC	287 kW		07/06→			
35.400 FDNLC	294 kW		07/06→			
35.400 FFDAK, FFDHK, FFDHLK	294 kW		07/06→			
35.400 FFDH-TM	294 kW		07/06→			
35.400 FFNHLC	294 kW		11/06→			
35.400 FFNLC	294 kW		07/06→			
35.410 FDNLC	301 kW		07/06→			
35.410 FFDAK	301 kW		07/06→			
35.410 FFNLC	301 kW		07/06→			
35.430 FDNLC	316 kW		07/06→			
35.430 FFDAK, FFDHK, FFDHLK	316 kW		07/06→			
35.430 FFDH-TM	316 kW		07/06→			
35.430 FFNLC	316 kW		07/06→			
35.440 FDNLC	324 kW		07/06→			
35.440 FFDAK, FFDHK, FFDHLK	324 kW		07/06→			
35.440 FFDH-TM	324 kW		07/06→			
35.440 FFNHLC	324 kW		11/06→			
35.440 FFNLC	324 kW		07/06→			
35.460 FFNLC	338 kW		07/06→			
35.480 FDNLC	353 kW		07/06→			
35.480 FFDAK	353 kW		07/06→			
35.480 FFDAK, FFDHK, FFDHLK	353 kW		07/06→			
35.480 FFDARS	353 kW		07/06→			
35.480 FFDH-TM	353 kW		07/06→			
35.480 FFNHLC	353 kW		11/06→			
35.480 FFNLC	353 kW		07/06→			
35.530 FFDAK	390 kW		07/06→			
35.530 FFNLC	390 kW		07/06→			
37.480 FFDC	353 kW		02/06→			
37.480 FFDK	353 kW		02/06→			
37.480 FFD-TM	353 kW		02/06→			

Manufacturer - Model	Power	Displ.	Year of Constr.	Remark	Part Number	Page
MAN - TGA						04/00→
37.530 FVDS, FVDLS	390 kW		07/06→	W5W / H7 / H7; Left; Number of light functions: 3; with bulbs; for vehicles without headlamp levelling	1EH 354 984-011 Headlight	16
39.390 FVNLC	287 kW		07/06→			
39.400 FVNLC	294 kW		07/06→	W5W / H7 / H7; Right; Number of light functions: 3; with bulbs; for vehicles without headlamp levelling	1EH 354 984-021 Headlight	16
39.430 FVNLC	316 kW		07/06→			
39.440 FVNLC	324 kW		07/06→			
39.480 FVNLC	353 kW		07/06→			
40.390, 40.400 FDAK-WW	287 - 294 kW		06/05→	W5W / H7 / H7; Left; Number of light functions: 3; with bulbs; for vehicles with headlamp levelling (electric)	1EH 354 984-031 Headlight	17
40.390, 40.400 FDAS-WW	287 - 294 kW		06/05→			
40.390, 40.400 FDK-WW, FDRK	287 - 294 kW		06/05→	W5W / H7 / H7; Right; Number of light functions: 3; with bulbs; for vehicles with headlamp levelling (electric)	1EH 354 984-041 Headlight	17
40.390, 40.400 FDS-WW, FDRS	287 - 294 kW		06/05→			
40.430, 40.440 FDAK-WW	316 - 324 kW		06/05→			
40.430, 40.440 FDAS-WW	316 - 324 kW		06/05→			
40.430 FDK-WW, FDRK	316 kW		06/05→	P21W / H4; Left; Yellow; with indicator / with high beam / with fog light; Number of light functions: 3; with bulbs	1NB 354 986-031 Spotlight	5, 23
40.430 FDS-WW, FDRS	316 kW		06/05→			
40.440 FDAK-WW	324 kW		06/05→	P21W / H4; Left; Yellow; with indicator / with high beam / with fog light; Number of light functions: 3; with bulbs	1NB 354 986-031 Fog Light	5, 23
40.440 FDAS-WW	324 kW		06/05→			
40.440 FDK-WW, FDRK	324 kW		06/05→			
40.440 FDS-WW, FDRS	324 kW		06/05→	P21W / H4; Right; Yellow; with indicator / with high beam / with fog light; Number of light functions: 3; with bulbs	1NB 354 986-041 Spotlight	6, 24
40.480 FDAK-WW	353 kW		06/05→			
40.480 FDAS-WW	353 kW		06/05→			
40.480 FDK-WW, FDRK	353 kW		06/05→	P21W / H4; Right; Yellow; with indicator / with high beam / with fog light; Number of light functions: 3; with bulbs	1NB 354 986-041 Fog Light	6, 24
40.480 FDS-WW; FDRS	353 kW		06/05→			
41.350 FFDC-TM, FFDRK-TM	257 kW		09/07→	H4 / PY21W; Left; White; with indicator / with high beam / with fog light; Number of light functions: 3; with bulbs	1NB 354 986-051 Spotlight	6, 24
41.360 FFD	265 kW		12/08→			
41.360 FFDC-TM, FFDRK-TM	265 kW		09/07→			
41.390 FFDC-TM, FFDRK-TM	287 kW		09/07→	H4 / PY21W; Left; White; with indicator / with high beam / with fog light; Number of light functions: 3; with bulbs	1NB 354 986-051 Fog Light	6, 24
41.400 FFD	294 kW		12/08→			
41.400 FFDC-TM, FFDRK-TM	294 kW		09/07→			
41.410 FFDAK	301 kW		07/06→	H4 / PY21W; Right; White; with indicator / with high beam / with fog light; Number of light functions: 3; with bulbs	1NB 354 986-061 Spotlight	6, 24
41.430 FFDAK	316 kW		07/06→			
41.430 FFDC-TM, FFDRK	316 kW		09/07→			
41.440 FFDAK	324 kW		07/06→	H4 / PY21W; Right; White; with indicator / with high beam / with fog light; Number of light functions: 3; with bulbs	1NB 354 986-061 Fog Light	6, 24
41.440 FFDC-TM, FFDRK-TM	324 kW		09/07→			
41.480 FFD	353 kW		12/08→			
41.480 FFDAK	353 kW		07/06→	P21W; Left / Right; Number of light functions: 1; with lamp base	2KA 003 989-081 Licence Plate Light	44
41.480 FFDARC	353 kW		07/06→			
41.480 FFDC, FFDRK, FFDRK-TM	353 kW		02/06→	Front; White; Number of light functions: 1	2PF 354 985-011 Position Light	45
41.480 FFDC-TM, FFDRK-TM	353 kW		09/07→			
41.480 FFDC-WW, FFDRK	353 kW		06/05→	Yellow; LED; Number of light functions: 1	2PS 354 985-001 Side Marker Light	45
41.480 FFDK, FFDK-TM	353 kW		02/06→			
41.480 FFDK-WW	353 kW		06/05→	R10W; without lamp base; with screw	9BG 121 587-031 Housing, licence plate light	27
41.480 FFD-TM	353 kW		02/06→			
41.480 FVDS, FVDLS	353 kW		07/06→			
41.530 FFDAK	353 kW		07/06→	Left; without gasket / seal	9ES 354 984-051 Diffusing Lens, headlight	4
41.530 FFDAK	390 kW		07/06→			
41.540 FVDS, FVDLS	397 kW		11/06→	Right; without gasket / seal	9ES 354 984-061 Diffusing Lens, headlight	4
26.350, 26.360 FDHK, FDHLK	257 - 265 kW		05/04→	W5W / H7 / H7; Left; Number of light functions: 3; with bulbs; for vehicles without headlamp levelling	1EH 354 984-011 Headlight	16
26.350 FDHC, FDHC/M	257 kW		04/05→			
				W5W / H7 / H7; Right; Number of light functions: 3; with bulbs; for vehicles without headlamp levelling	1EH 354 984-021 Headlight	16
				W5W / H7 / H7; Left; Number of light functions: 3; with bulbs; for vehicles with headlamp levelling (electric)	1EH 354 984-031 Headlight	17
				W5W / H7 / H7; Right; Number of light functions: 3; with bulbs; for vehicles with headlamp levelling (electric)	1EH 354 984-041 Headlight	17
				P21W / H4; Left; Yellow; with indicator / with high beam / with fog light; Number of light functions: 3; with bulbs	1NB 354 986-031 Spotlight	5, 23
				P21W / H4; Left; Yellow; with indicator / with high beam / with fog light; Number of light functions: 3; with bulbs	1NB 354 986-031 Fog Light	5, 23
				P21W / H4; Right; Yellow; with indicator / with high beam / with fog light; Number of light functions: 3; with bulbs	1NB 354 986-041 Spotlight	6, 24
				P21W / H4; Right; Yellow; with indicator / with high beam / with fog light; Number of light functions: 3; with bulbs	1NB 354 986-041 Fog Light	6, 24
				H4 / PY21W; Left; White; with indicator / with high beam / with fog light; Number of light functions: 3; with bulbs	1NB 354 986-051 Spotlight	6, 24
				H4 / PY21W; Left; White; with indicator / with high beam / with fog light; Number of light functions: 3; with bulbs	1NB 354 986-051 Fog Light	6, 24
				H4 / PY21W; Right; White; with indicator / with high beam / with fog light; Number of light functions: 3; with bulbs	1NB 354 986-061 Spotlight	6, 24
				H4 / PY21W; Right; White; with indicator / with high beam / with fog light; Number of light functions: 3; with bulbs	1NB 354 986-061 Fog Light	6, 24

Manufacturer - Model	Power	Displ.	Year of Constr.	Remark	Part Number	Page
MAN - TGA						04/00→
26.350, 26.360 FDHK, FDHLK	257 - 265 kW		05/04→	P21W; Left / Right; Number of light functions: 1; with lamp base	2KA 003 389-081 Licence Plate Light	44
26.350 FDHC, FDHC/M	257 kW		04/05→	Front; White; Number of light functions: 1	2PF 354 985-011 Position Light	45
				Yellow; LED; Number of light functions: 1	2PS 354 985-001 Side Marker Light	45
				→05/05; P21W / R5W; Left; Number of light functions: 9; 12 V / 24 V; with lamp base	2VD 008 204-251 Combination Rearlight	38
				→05/05; P21W / R5W; Right; Number of light functions: 8; 12 V / 24 V; with lamp base	2VP 008 204-241 Combination Rearlight	43
				R10W; without lamp base; with screw	9BG 121 587-031 Housing, licence plate light	27
				Left; without gasket / seal	9ES 354 984-051 Diffusing Lens, headlight	4
				Right; without gasket / seal	9ES 354 984-061 Diffusing Lens, headlight	4
MAN - TGL						04/05→
10.180 FC, FRC, FLC, FLRC	132 kW		04/05→	W5W / H7 / H7; Left; Number of light functions: 3; with bulbs; for vehicles without headlamp levelling	1EH 354 984-011 Headlight	16
10.180 FK, FRK	132 kW		04/05→			
10.210 FC, FRC, FLC, FLRC	151 kW		04/05→	W5W / H7 / H7; Right; Number of light functions: 3; with bulbs; for vehicles without headlamp levelling	1EH 354 984-021 Headlight	16
10.210 FK, FRK	151 kW		04/05→			
10.220 FC, FLC, FRC, FLRC	162 kW		04/05→	W5W / H7 / H7; Left; Number of light functions: 3; with bulbs; for vehicles with headlamp levelling (electric)	1EH 354 984-031 Headlight	17
10.220 FK, FRK	162 kW		04/05→			
10.240 FC, FRC, FLC, FLRC	176 kW		04/05→	W5W / H7 / H7; Right; Number of light functions: 3; with bulbs; for vehicles with headlamp levelling (electric)	1EH 354 984-041 Headlight	17
10.240 FK, FRK	176 kW		04/05→			
10.250 FC, FLC, FRC, FLRC	184 kW		04/05→	P21W / H4; Left; Yellow; with indicator / with high beam / with fog light; Number of light functions: 3; with bulbs	1NB 354 986-031 Spotlight	5, 23
10.250 FK, FRK	184 kW		04/05→			
12.180 FC, FRC, FLC, FLRC	132 kW		04/05→	P21W / H4; Right; Yellow; with indicator / with high beam / with fog light; Number of light functions: 3; with bulbs	1NB 354 986-031 Fog Light	5, 23
12.180 FK, FRK	132 kW		04/05→			
12.210 FC, FRC, FLC, FLRC	151 kW		04/05→	P21W / H4; Right; Yellow; with indicator / with high beam / with fog light; Number of light functions: 3; with bulbs	1NB 354 986-041 Spotlight	6, 24
12.210 FK, FRK	151 kW		04/05→			
12.220 FC, FRC, FLC, FLRC	162 kW		04/05→	P21W / H4; Right; Yellow; with indicator / with high beam / with fog light; Number of light functions: 3; with bulbs	1NB 354 986-041 Fog Light	6, 24
12.220 FK, FRK	162 kW		04/05→			
12.240 FC, FRC, FLC, FLRC	176 kW		04/05→	P21W / H4; Right; Yellow; with indicator / with high beam / with fog light; Number of light functions: 3; with bulbs	1NB 354 986-041 Fog Light	6, 24
12.240 FK, FRK	176 kW		04/05→			
12.250 FC, FLC, FRC, FLRC	184 kW		04/05→	P21W / H4; Right; Yellow; with indicator / with high beam / with fog light; Number of light functions: 3; with bulbs	1NB 354 986-051 Spotlight	6, 24
12.250 FK, FRK	184 kW		04/05→			
7.150, 8.150 FC, FRC, FLC, FLRC	110 kW		04/05→	H4 / PY21W; Left; White; with indicator / with high beam / with fog light; Number of light functions: 3; with bulbs	1NB 354 986-051 Fog Light	6, 24
7.180 FC, FLC, FRC, FLRC	132 kW		04/05→			
7.220 FC, FLC, FRC, FLRC	162 kW		04/05→	H4 / PY21W; Right; White; with indicator / with high beam / with fog light; Number of light functions: 3; with bulbs	1NB 354 986-061 Spotlight	6, 24
7.250 FC, FLC, FRC, FLRC	184 kW		04/05→			
8.180 FC, FRC, FLC, FLRC	132 kW		04/05→	H4 / PY21W; Right; White; with indicator / with high beam / with fog light; Number of light functions: 3; with bulbs	1NB 354 986-061 Fog Light	6, 24
8.180 FK, FK-L, FRK, FRK-L	132 kW		04/05→			
8.210 FC, FRC, FLC, FLRC	151 kW		04/05→	P21W; Left / Right; Number of light functions: 1; with lamp base	2KA 003 389-081 Licence Plate Light	44
8.210 FK, FK-L, FRK, FRK-L	151 kW		04/05→	Front; White; Number of light functions: 1	2PF 354 985-011 Position Light	45
8.220 FC, FLC, FRC, FLRC	162 kW		04/05→	Yellow; LED; Number of light functions: 1	2PS 354 985-001 Side Marker Light	45
8.220 FK, FRK, FK-L, FRK-L	162 kW		04/05→	T4W; Lateral Mounting; Red/Black; Number of light functions: 1; with lamp base	2XS 005 020-041 Marker Lamp	45
8.240 FC, FRC, FLC, FLRC	176 kW		04/05→	R10W; without lamp base; with screw	9BG 121 587-031 Housing, licence plate light	27
8.240 FK, FK-L, FRK, FRK-L	176 kW		04/05→			
8.250 FC, FLC, FLRC, FRC	184 kW		04/05→	T4W; Lateral Mounting; Red; without lamp base; with screws	9EL 132 215-011 Lens, marker lamp	33
8.250 FK, FK-L, FRK, FRK-L	184 kW		04/05→	Left; without gasket / seal	9ES 354 984-051 Diffusing Lens, headlight	4
				Right; without gasket / seal	9ES 354 984-061 Diffusing Lens, headlight	4
8.150 FK, FRK, FK-L, FRK-L	110 kW		10/06→	W5W / H7 / H7; Left; Number of light functions: 3; with bulbs; for vehicles without headlamp levelling	1EH 354 984-011 Headlight	16
				W5W / H7 / H7; Right; Number of light functions: 3; with bulbs; for vehicles without headlamp levelling	1EH 354 984-021 Headlight	16
				W5W / H7 / H7; Left; Number of light functions: 3; with bulbs; for vehicles with headlamp levelling (electric)	1EH 354 984-031 Headlight	17

Manufacturer - Model	Power	Displ.	Year of Constr.	Remark	Part Number	Page
MAN - TGL						04/05→
8.150 FK, FRK, FK-L, FRK-L	110 kW		10/06→	W5W / H7 / H7; Right; Number of light functions: 3; with bulbs; for vehicles with headlamp levelling (electric)	1EH 354 984-041 Headlight	17
				P21W / H4; Left; Yellow; with indicator / with high beam / with fog light; Number of light functions: 3; with bulbs	1NB 354 986-031 Spotlight	5, 23
				P21W / H4; Left; Yellow; with indicator / with high beam / with fog light; Number of light functions: 3; with bulbs	1NB 354 986-031 Fog Light	5, 23
				P21W / H4; Right; Yellow; with indicator / with high beam / with fog light; Number of light functions: 3; with bulbs	1NB 354 986-041 Spotlight	6, 24
				P21W / H4; Right; Yellow; with indicator / with high beam / with fog light; Number of light functions: 3; with bulbs	1NB 354 986-041 Fog Light	6, 24
				H4 / PY21W; Left; White; with indicator / with high beam / with fog light; Number of light functions: 3; with bulbs	1NB 354 986-051 Spotlight	6, 24
				H4 / PY21W; Left; White; with indicator / with high beam / with fog light; Number of light functions: 3; with bulbs	1NB 354 986-051 Fog Light	6, 24
				H4 / PY21W; Right; White; with indicator / with high beam / with fog light; Number of light functions: 3; with bulbs	1NB 354 986-061 Spotlight	6, 24
				H4 / PY21W; Right; White; with indicator / with high beam / with fog light; Number of light functions: 3; with bulbs	1NB 354 986-061 Fog Light	6, 24
				P21W; Left / Right; Number of light functions: 1; with lamp base	2KA 003 389-081 Licence Plate Light	44
				Front; White; Number of light functions: 1	2PF 354 985-011 Position Light	45
				Yellow; LED; Number of light functions: 1	2PS 354 985-001 Side Marker Light	45
				R10W; without lamp base; with screw	9BG 121 587-031 Housing, licence plate light	27
				T4W; Lateral Mounting; Red; without lamp base; with screws	9EL 132 215-011 Lens, marker lamp	33
				Left; without gasket / seal	9ES 354 984-051 Diffusing Lens, headlight	4
				Right; without gasket / seal	9ES 354 984-061 Diffusing Lens, headlight	4
				MAN - TGM		
12.240 FLC, FLLC	176 kW		10/05→	W5W / H7 / H7; Left; Number of light functions: 3; with bulbs; for vehicles without headlamp levelling	1EH 354 984-011 Headlight	16
12.250 FLC, FLLC	184 kW		10/05→			
12.280 FC, FLC, FLLC	206 kW		10/05→	W5W / H7 / H7; Right; Number of light functions: 3; with bulbs; for vehicles without headlamp levelling	1EH 354 984-021 Headlight	16
12.290 FLC, FLLC	213 kW		10/05→			
13.240 FAL, FALC, FALRC, FAEC, FAERC, FALR	176 kW		04/06→			
13.240 FALK, FALRK, FALK-L, FALRK-L	176 kW		04/06→	W5W / H7 / H7; Left; Number of light functions: 3; with bulbs; for vehicles with headlamp levelling (electric)	1EH 354 984-031 Headlight	17
13.250 FAEC, FAERC, FALC, FAL, FALRC, FALR	184 kW		10/05→	W5W / H7 / H7; Right; Number of light functions: 3; with bulbs; for vehicles with headlamp levelling (electric)	1EH 354 984-041 Headlight	17
13.250 FALK, FALRK, FALK-L, FALRK-L	184 kW		10/05→	P21W / H4; Left; Yellow; with indicator / with high beam / with fog light; Number of light functions: 3; with bulbs	1NB 354 986-031 Spotlight	5, 23
13.280 FAEC, FAERC, FAL, FALC, FALRC	206 kW		04/06→	P21W / H4; Left; Yellow; with indicator / with high beam / with fog light; Number of light functions: 3; with bulbs	1NB 354 986-031 Fog Light	5, 23
13.280 FALK, FALRK, FALK-L, FALRK-L	206 kW		04/06→	P21W / H4; Right; Yellow; with indicator / with high beam / with fog light; Number of light functions: 3; with bulbs	1NB 354 986-041 Spotlight	6, 24
13.290 FAEC, FAERC, FAL, FALR, FALC, FALRC	213 kW		10/05→	P21W / H4; Right; Yellow; with indicator / with high beam / with fog light; Number of light functions: 3; with bulbs	1NB 354 986-041 Fog Light	6, 24
13.290 FALK, FALRK, FALK-L, FALRK-L	213 kW		10/05→	P21W / H4; Right; Yellow; with indicator / with high beam / with fog light; Number of light functions: 3; with bulbs	1NB 354 986-041 Fog Light	6, 24
15.240 FC, FLC, FLLC, FLRC, FLLRC	176 kW		10/05→	H4 / PY21W; Left; White; with indicator / with high beam / with fog light; Number of light functions: 3; with bulbs	1NB 354 986-051 Spotlight	6, 24
15.240 FLK, FLRK	176 kW		10/05→	H4 / PY21W; Left; White; with indicator / with high beam / with fog light; Number of light functions: 3; with bulbs	1NB 354 986-051 Fog Light	6, 24
15.250 FC, FLC, FLRC, FLLC, FLLRC	184 kW		10/05→	H4 / PY21W; Right; White; with indicator / with high beam / with fog light; Number of light functions: 3; with bulbs	1NB 354 986-061 Spotlight	6, 24
15.250 FLK, FLRK	184 kW		10/05→	H4 / PY21W; Right; White; with indicator / with high beam / with fog light; Number of light functions: 3; with bulbs	1NB 354 986-061 Fog Light	6, 24
15.280 FC, FLC, FLRC, FLLC, FLLRC	206 kW		10/05→			
15.280 FLK, FLRK	206 kW		10/05→			
15.290 FC, FLC, FLRC, FLLC, FLLRC	213 kW		10/05→			
15.290 FLK, FLRK	213 kW		10/05→			
15.330 FC, FLC, FRC, FLRC	240 kW		10/05→			
15.330 FLK, FLRK	240 kW		10/05→			
15.340 FC, FLC, FLRC	250 kW		10/05→	Yellow; LED; Number of light functions: 1	2PS 354 985-001 Side Marker Light	45
15.340 FLK, FLRK	250 kW		10/05→			
18.240 FAC, FARC	176 kW		10/05→	Left; without gasket / seal	9ES 354 984-051 Diffusing Lens, headlight	4

Manufacturer - Model	Power	Displ.	Year of Constr.	Remark	Part Number	Page
MAN - TGM						10/05→
18.240 FAK, FARK, FAK-L, FARK-L	176 kW		05/06→	Right; without gasket / seal	9ES 354 984-061	4
18.240 FC, FRC, FLC, FLRC, FLLC, FLLRC	176 kW		10/05→		Diffusing Lens, headlight	
18.240 FK, FRK, FLK, FK-L, FLRK	176 kW		10/05→			
18.250 FAC, FARC	184 kW		10/05→			
18.250 FAK, FARK, FAK-L, FARK-L	184 kW		10/05→			
18.250 FC, FLC, FLLC, FRC, FLRC, FLLRC	184 kW		10/05→			
18.250 FK, FLK, FRK, FLRK	184 kW		10/05→			
18.280 FAC, FARC	206 kW		10/05→			
18.280 FAK, FARK, FAK-L, FARK-L	206 kW		10/05→			
18.280 FC, FRC, FLC, FLRC, FLLC, FLLRC	206 kW		10/05→			
18.280 FK, FLK, FRK, FLRK, FK-L	206 kW		10/05→			
18.290 FAC, FARC	213 kW		10/05→			
18.290 FAK, FARK, FAK-L, FARK-L	213 kW		10/05→			
18.290 FC, FLC, FRC, FLRC, FLLC, FLLRC	213 kW		10/05→			
18.290 FK, FLK, FRK, FLRK	213 kW		10/05→			
18.330 FAC, FARC	240 kW		10/05→			
18.330 FAK, FARK, FAK-L, FARK, L	240 kW		10/05→			
18.330 FC, FRC, FLC, FLRC, FLLC, FLLRC	240 kW		10/05→			
18.330 FK, FLK, FRK, FLRK, FK-L	240 kW		10/05→			
18.340 FAC, FARC	250 kW		10/05→			
18.340 FAK, FARK, FAK-L, FARK-L	250 kW		10/05→			
18.340 FC, FLC, FLRC, FLLC, FLLRC, FRC	250 kW		10/05→			
18.340 FK, FRK, FLK, FLRK	250 kW		10/05→			
22.240 FNLLC	176 kW		10/05→			
22.250 FNLLC	184 kW		10/05→			
22.280 FNL, 22.280 FNLLC	206 kW		10/05→			
22.290 FNL, 22.290 FNLLC	213 kW		10/05→			
26.280 FD	206 kW		10/05→			
26.280 FDK-HK, FDRK-HK	206 kW		04/06→			
26.280 FD-TM, FDR-TM	206 kW		04/06→			
26.280 FNLC, FNLLC, FNLRC, FNLLRC	206 kW		10/05→			
26.290 FD, FDR	213 kW		10/05→			
26.290 FDK-HK, FDRK-HK	213 kW		10/05→			
26.290 FD-TM, FDR-TM	213 kW		07/08→			
26.290 FNLC, FNLLC, FNLRC, FNLLRC, FVL	213 kW		10/05→			
26.330 FD, FDR	240 kW		10/05→			
26.330 FDK-HK, FDRK-HK	240 kW		04/06→			
26.330 FD-TM, FDR-TM	240 kW		04/06→			
26.330 FNLC, FNLLC, FNLRC, FNLLRC, FVL	240 kW		10/05→			
26.340 FD, FDR	250 kW		10/05→			
26.340 FDK-HK, FDRK-HK	250 kW		10/05→			
26.340 FD-TM, FDR-TM	250 kW		07/08→			
26.340 FNLC, FNLLC, FNLRC, FNLLRC	250 kW		10/05→			
MAN - TGS						09/07→
18.320 FAC, FHLC	235 kW		10/07→	for construction site vehicles; W5W / H7 / H7;	1EH 354 984-011	16
18.320 FAK, FAK-L, FALK, FALK-L, FHLK, FHLK/M	235 kW		10/07→	Left; Number of light functions: 3; with bulbs; for vehicles without headlamp levelling	Headlight	
18.320 FAS, FHLS, FHLS/M	235 kW		10/07→	for construction site vehicles; W5W / H7 / H7;	1EH 354 984-021	16
18.320 FC, FLC, FLRC, FLLC, FLLRC, FLLW, FLLW/N	235 kW		10/07→	Right; Number of light functions: 3; with bulbs; for vehicles without headlamp levelling	Headlight	
18.320 FK, FK-L, FLK, FLK/M	235 kW		10/07→	for construction site vehicles; W5W / H7 / H7;	1EH 354 984-031	17
18.320 FLS, FLS/M, FLS-TS, FLRS, FLRS/M, FLLS, FLLS/N, FLLRS	235 kW		10/07→	Left; Number of light functions: 3; with bulbs; for vehicles with headlamp levelling (electric)	Headlight	
18.360 FAC, FHLC	265 kW		10/07→	for construction site vehicles; W5W / H7 / H7;	1EH 354 984-041	17
18.360 FAK, FAK-L, FALK, FALK-L, FHLK, FHLK/M	265 kW		10/07→	Right; Number of light functions: 3; with bulbs; for vehicles with headlamp levelling (electric)	Headlight	
18.360 FAS, FALS, FHLS, FHLS/M	265 kW		10/07→	H7 / H7 / PY21W; Left; Number of light functions: 4; with bulbs; for vehicles without headlamp levelling	1EH 354 987-011	17
18.360 FC, FLC, FLRC, FLLC, FLLRC, FLLW, FLLW/N	265 kW		10/07→	H7 / H7 / PY21W; Right; Number of light functions: 4; with bulbs; for vehicles without headlamp levelling	1EH 354 987-021	18

Manufacturer - Model	Power	Displ.	Year of Constr.	Remark	Part Number	Page
MAN - TGS						09/07→
18.360 FK, FK-L, FLK, FLK/M	265 kW		10/07→	H7 / H7 / PY21W / H21 W; Left; Number of light functions: 5; with bulbs; for vehicles without headlamp levelling	1EH 354 987-031 Headlight	18
18.360 FLS, FLS/M, FLS-TS, FLRS, FLRS/M, FLLS, FLLS/N, FLLRS	265 kW		10/07→	H7 / H7 / PY21W; Left; Number of light functions: 4; with bulbs; for vehicles with headlamp levelling (electric)	1EH 354 987-051 Headlight	18
18.400 FAC, FHLC	294 kW		10/07→	H7 / H7 / PY21W; Right; Number of light functions: 4; with bulbs; for vehicles with headlamp levelling (electric)	1EH 354 987-061 Headlight	19
18.400 FAK, FAK-L, FALK, FALK-L, FHLK, FHLK/M	294 kW		10/07→	H4; Left; 24 V; with bulbs	1FP 354 986-011 Spotlight	5, 23
18.400 FAS, FALS, FHLS, FHLS/M	294 kW		10/07→	H4; Left; 24 V; with bulbs	1FP 354 986-011 Fog Light	5, 23
18.400 FC, FLC, FLRC, FLLC, FLLRC, FLLW, FLLW/N	294 kW		10/07→	H4; Right; 24 V; with bulbs	1FP 354 986-021 Spotlight	5, 23
18.400 FK, FK-L, FLK, FLK/M	294 kW		10/07→	H4; Right; 24 V; with bulbs	1FP 354 986-021 Fog Light	5, 23
18.400 FLS, FLS/M, FLS-TS, FLRS, FLRS/M, FLLS, FLLS/N, FLLRS	294 kW		10/07→	H7 / H7 / PY21W; Left; Number of light functions: 4; with bulbs; for vehicles with headlamp levelling (electric)	1LH 354 987-071 Headlight	20
18.440 FAC, FHLC	324 kW		10/07→	H7 / H7 / PY21W; Right; Number of light functions: 4; with bulbs; for vehicles with headlamp levelling (electric)	1LH 354 987-081 Headlight	21
18.440 FAK, FAK-L, FALK, FALK-L, FHLK, FHLK/M	324 kW		10/07→	for construction site vehicles: P21W / H4; Left; Yellow; with indicator / with high beam / with fog light; Number of light functions: 3; with bulbs	1NB 354 986-031 Spotlight	5, 23
18.440 FAS, FALS, FHLS, FHLS/M	324 kW		10/07→	for construction site vehicles: P21W / H4; Left; Yellow; with indicator / with high beam / with fog light; Number of light functions: 3; with bulbs	1NB 354 986-031 Fog Light	5, 23
18.440 FC, FLC, FLRC, FLLC, FLLRC, FLLW, FLLW/N	324 kW		10/07→	for construction site vehicles: P21W / H4; Right; Yellow; with indicator / with high beam / with fog light; Number of light functions: 3; with bulbs	1NB 354 986-041 Spotlight	6, 24
18.440 FK, FK-L, FLK, FLK/M	324 kW		10/07→	for construction site vehicles: P21W / H4; Right; Yellow; with indicator / with high beam / with fog light; Number of light functions: 3; with bulbs	1NB 354 986-041 Fog Light	6, 24
18.440 FLS, FLS/M, FLS-TS, FLRS, FLRS/M, FLLS, FLLS/N, FLLRS	324 kW		10/07→	for construction site vehicles: H4 / PY21W; Left; White; with indicator / with high beam / with fog light; Number of light functions: 3; with bulbs	1NB 354 986-051 Spotlight	6, 24
18.480 FAC, FHLC	353 kW		10/07→	for construction site vehicles: H4 / PY21W; Left; White; with indicator / with high beam / with fog light; Number of light functions: 3; with bulbs	1NB 354 986-051 Fog Light	6, 24
18.480 FAK, FAK-L, FALK, FALK-L, FHLK, FHLK/M	353 kW		10/07→	for construction site vehicles: H4 / PY21W; Right; White; with indicator / with high beam / with fog light; Number of light functions: 3; with bulbs	1NB 354 986-061 Spotlight	6, 24
18.480 FAS, FALS, FHLS, FHLS/M	353 kW		10/07→	for construction site vehicles: H4 / PY21W; Right; White; with indicator / with high beam / with fog light; Number of light functions: 3; with bulbs	1NB 354 986-061 Fog Light	6, 24
18.480 FC, FLC, FLRC, FLLC, FLLRC, FLLW, FLLW/N	353 kW		10/07→	Front; White; Number of light functions: 1	2PF 354 985-011 Position Light	45
18.480 FK, FK-L, FLK, FLK/M	353 kW		10/07→	Yellow; LED; Number of light functions: 1	2PS 354 985-001 Side Marker Light	45
18.480 FLS, FLS/M, FLS-TS, FLRS, FLRS/M, FLLS, FLLS/N, FLLRS	353 kW		10/07→	for construction site vehicles: Left; without gasket / seal	9ES 354 984-051 Diffusing Lens, headlight	4
18.540 FAC, FHLC	397 kW		10/07→	for construction site vehicles: Right; without gasket / seal	9ES 354 984-061 Diffusing Lens, headlight	4
18.540 FAK, FAK-L, FALK, FALK-L, FHLK, FHLK/M	397 kW		10/07→	Left; without gasket / seal	9ES 354 987-091 Diffusing Lens, headlight	4
18.540 FAS, FALS, FHLS, FHLS/M	397 kW		10/07→	Right; without gasket / seal	9ES 354 987-101 Diffusing Lens, headlight	4
18.540 FC, FLC, FLRC, FLLC, FLLRC, FLLW, FLLW/N	397 kW		10/07→			
18.540 FK, FK-L, FLK, FLK/M	397 kW		10/07→			
18.540 FLS, FLS/M, FLRS, FLRS/M, FLLS, FLLS/N, FLLRS	397 kW		10/07→			
19.360 FS/M-WW, FLS/M-WW, FRS/M-WW, FLRS/M-WW	265 kW		02/11→			
19.400 FS/M-WW, FLS/M-WW, FRS/M-WW, FLRS/M-WW	294 kW		02/11→			
19.440 FS-WW, FRS-WW, FLS-WW, FLRS-WW	324 kW		02/11→			
19.480 FS/M-WW, FRS/M-WW, FLS/M-WW, FLRS/M-WW	353 kW		02/11→			
24.320 FNLLW/N	235 kW		10/07→			
24.360 FNLLW/N	265 kW		10/07→			
24.360 FPLS, FPLRS	265 kW		10/07→			
24.400 FNLLW/N	294 kW		10/07→			
24.400 FPLS, FPLRS	294 kW		10/07→			
24.440 FNLLW/N	324 kW		10/07→			
24.440 FPLS, FPLRS	324 kW		10/07→			
24.480 FPLS, FPLRS	353 kW		10/07→			
24.540 FPLS, FPLRS	397 kW		10/07→			
26.320 FDAC, FDALC, FDHLC, FDHLC/M	235 kW		07/08→			
26.320 FDAK, FDALK, FDHK, FDHLK	235 kW		07/08→			
26.320 FDAS, FDALS, FDHS, FDHLS, FDHLS/M	235 kW		07/08→			
26.320 FDC, FDRC, FDLC, FDLC/M, FDLRC, FDLRC/M, FNHLC	235 kW		07/08→			
26.320 FDK, FDLK	235 kW		07/08→			
26.320 FDS, FDLs, FDLs/M, FDRS, FDLRS, FDLRS/M, FNHLS	235 kW		07/08→			
26.320 FD-TM	235 kW		07/08→			
26.320 FNLC, FNLC, FNLLC, FNLLRC, FNLLW, FVLC, FVLC-KO	235 kW		10/07→			

Manufacturer - Model	Power	Displ.	Year of Constr.	Remark	Part Number	Page
MAN - TGS						09/07→
26.320 FNLS, FNLRS, FNLLS, FPLS, FVLS	235 kW		07/08→			
26.320 FVHLC	235 kW		10/07→			
26.360 FDAC, FDALC, FDHLC, FDHLC/M	265 kW		08/08→			
26.360 FDAK, FDALK, FDHK, FDHLK	265 kW		08/08→			
26.360 FDAS, FDALS, FDHS, FDHLS, FDHLS/M	265 kW		08/08→			
26.360 FDC, FDC/M, FDLRC, FDLRC/M, FDLRC, FDLRC, FNHLC	265 kW		08/08→			
26.360 FDK, FDLK, FDRK	265 kW		08/08→			
26.360 FDS, FDRS, FDRS/M, FDLRS, FDLRS, FNHLS	265 kW		08/08→			
26.360 FD-TM	265 kW		07/08→			
26.360 FNLC, FNLRC, FNLLC, FNLLRC, FVLC, FVL-KO	265 kW		10/07→			
26.360 FNLLW	265 kW		04/08→			
26.360 FNLS, FNLLS, FNLRS, FPLS, FPLRS, FVLS	265 kW		08/08→			
26.360 FPHLS	265 kW		05/08→			
26.360 FVHLC	265 kW		10/07→			
26.360 FVHLS	265 kW		05/08→			
26.400 FDAC, FDALC, FDHLC, FDHLC/M	294 kW		02/09→			
26.400 FDAK, FDALK, FDHK, FDHLK	294 kW		11/07→			
26.400 FDAS, FDALS, FDHS, FDHLS, FDHLS/M	294 kW		09/07→			
26.400 FDC, FDC/M, FDLRC, FDLRC/M, FDLRC, FDLRC/M, FNHLC	294 kW		08/08→			
26.400 FDK, FDLK	294 kW		02/09→			
26.400 FDS, FDS/M, FDLRS, FDLRS, FDLRS, FNHLS	294 kW		02/09→			
26.400 FD-TM	294 kW		07/08→			
26.400 FNLC, FNLRC, FNLLC, FNLLRC, FVLC, FVL-KO, FNLLW	294 kW		10/07→			
26.400 FNLS, FNLRS, FNLLS, FNLLRS, FPLS, FPLRS, FVLS	294 kW		02/09→			
26.400 FPHLS	294 kW		05/08→			
26.400 FVHLC	294 kW		10/07→			
26.400 FVHLS	294 kW		05/08→			
26.440 FDAC, FDALC, FDHLC, FDHLC/M	324 kW		02/09→			
26.440 FDAK, FDALK, FDHK, FDHLK	324 kW		11/07→			
26.440 FDAS, FDALS, FDHLS, FDHLS/M	324 kW		02/09→			
26.440 FDC, FDC/M, FDLRC, FDLRC/M, FDLRC, FDLRC/M, FNHLC	324 kW		02/09→			
26.440 FDK, FDLK	324 kW		07/08→			
26.440 FDS, FDRS, FDS/M, FDLRS, FDLRS, FNHLS	324 kW		02/09→			
26.440 FD-TM	324 kW		07/08→			
26.440 FNLC, FNLRC, FNLLC, FNLLW, FNLLRC, FVLC, FVL-KO	324 kW		10/07→			
26.440 FNLS, FNLLS, FNLRS, FPLS, FPLRS, FVLS	324 kW		02/09→			
26.440 FPHLS	324 kW		05/08→			
26.440 FVHLC	324 kW		10/07→			
26.440 FVHLS	324 kW		05/08→			
26.480 FDAC, FDALC, FDHLC, FDHLC/M	353 kW		02/09→			
26.480 FDAK, FDALK, FDHK, FDHLK	353 kW		02/09→			
26.480 FDAS, FDALS, FDHS, FDHLS	353 kW		02/09→			
26.480 FDC, FDC/M, FDLRC, FDLRC/M, FDLRC, FDLRC/M, FNHLC	353 kW		02/09→			
26.480 FDK, FDLK	353 kW		07/08→			
26.480 FDS, FDS/M, FDLRS, FDLRS, FDLRS, FNHLS	353 kW		02/09→			
26.480 FNLC, FNLRC, FNLLC, FNLLRC, FNLLW, FVLC, FVL-KO	353 kW		10/07→			
26.480 FNLS, FNLLS, FNLRS, FPLS, FPLRS, FVLS	353 kW		02/09→			

Manufacturer - Model	Power	Displ.	Year of Constr.	Remark	Part Number	Page
MAN - TGS						09/07→
26.480 FPHLS	353 kW		05/08→			
26.480 FVHLC	353 kW		10/07→			
26.480 FVHLS	353 kW		05/08→			
26.540 FDAC, FDALC, FDHLC, FDHLC/M	397 kW		02/09→			
26.540 FDAK, FDALK, FDHLK	397 kW		11/07→			
26.540 FDAS, FDALS, FDHLS	397 kW		02/09→			
26.540 FDC, FDC/M, FDLC, FDLC/M, FDLRC, FDLRC/M, FNHLC	397 kW		02/09→			
26.540 FDK, FDLK	397 kW		02/09→			
26.540 FDS, FDS/M, FDLS, FDRS, FDLRS, FDLS/M, FNHLS	397 kW		02/09→			
26.540 FNLC, FNLRC, FNLLC, FNLLRC, FNLLW, FVLC, FVL-KO	397 kW		10/07→			
26.540 FNLS, FNLLS, FPLS, FPLRS, FVLS	397 kW		02/09→			
28.320 FNHLC	235 kW		07/08→			
28.320 FNLC	235 kW		07/08→			
28.320 FNLS	235 kW		07/08→			
28.360 FANLC, FNHLC	265 kW		08/08→			
28.360 FANLK	265 kW		08/08→			
28.360 FNLC	265 kW		08/08→			
28.360 FNLS	265 kW		08/08→			
28.400 FANLC, FNHLC	294 kW		08/08→			
28.400 FANLK	294 kW		08/08→			
28.400 FNLC	294 kW		08/08→			
28.400 FNLS	294 kW		08/08→			
28.440 FANLC, FNHLC	324 kW		08/08→			
28.440 FANLK	324 kW		08/08→			
28.440 FNLC	324 kW		08/08→			
28.440 FNLS	324 kW		08/08→			
28.480 FANLC, FNHLC	353 kW		08/08→			
28.480 FANLK	353 kW		08/08→			
28.480 FNLC	353 kW		08/08→			
28.480 FNLS	353 kW		08/08→			
28.540 FNHLC	397 kW		06/08→			
28.540 FNLC	397 kW		02/09→			
28.540 FNLS	397 kW		02/09→			
32.320 FFD-TM	235 kW		02/09→			
32.360 FFDR	265 kW		08/08→			
32.360 FFD-TM, FFDR-TM	265 kW		10/07→			
32.400 FFDR	294 kW		08/08→			
32.400 FFD-TM, FFDR-TM	294 kW		10/07→			
32.440 FFDR	324 kW		08/08→			
32.440 FFD-TM, FFDR-TM	324 kW		10/07→			
32.480 FFD-TM	353 kW		08/08→			
33.360 FDAC, FDALC	265 kW		06/08→			
33.360 FDAK, FDALK, FDHK	265 kW		10/07→			
33.360 FDAS, FDALS, FDHS	265 kW		10/07→			
33.360 FDC, FDLC	265 kW		06/08→			
33.360 FDK, FDLK	265 kW		02/09→			
33.360 FDS, FDLS	265 kW		06/08→			
33.400 FDAC, FDALC	294 kW		07/08→			
33.400 FDAK, FDALK, FDHK	294 kW		07/08→			
33.400 FDAS, FDALS, FDHS	294 kW		07/08→			
33.400 FDC, FDLC	294 kW		06/08→			
33.400 FDK, FDLK	294 kW		07/08→			
33.400 FDS, FDLS	294 kW		07/08→			
33.440 FDAC, FDALC	324 kW		07/08→			
33.440 FDAK, FDALK, FDHK	324 kW		11/07→			
33.440 FDAS, FDALS, FDHS	324 kW		10/07→			
33.440 FDC, FDLC	324 kW		06/08→			
33.440 FDK, FDLK	324 kW		06/08→			
33.440 FDS, FDLS, FDLS/M	324 kW		06/08→			
33.480 FDAC, FDALC	353 kW		08/08→			
33.480 FDAK, FDALK	353 kW		08/08→			
33.480 FDAS, FDALS, FDHS	353 kW		10/07→			
33.480 FDC, FDC/M, FDLC, FDLC/M	353 kW		08/08→			
33.480 FDK, FDLK	353 kW		08/08→			
33.480 FDS, FDLS, FDLS/M	353 kW		08/08→			
33.540 FDAC, FDALC	397 kW		02/09→			
33.540 FDAK, FDALK	397 kW		02/09→			
33.540 FDAS, FDALS	397 kW		02/09→			
33.540 FDC, FDLC, FDLC/M	397 kW		02/09→			
33.540 FDK, FDLK	397 kW		02/09→			
33.540 FDS, FDLS, FDLS/M	397 kW		02/09→			
35.320 FFDAK	235 kW		06/08→			
35.320 FFDAK, FFDHLK	235 kW		06/08→			

Manufacturer - Model	Power	Displ.	Year of Constr.	Remark	Part Number	Page
MAN - TGS						09/07→
35.320 FFDC, FFDLC, FDNLC	235 kW		06/08→			
35.320 FFDK, FFDLK	235 kW		08/08→			
35.320 FFD-TM	235 kW		10/07→			
35.320 FFNLC	235 kW		01/09→			
35.360 FFDAK	265 kW		06/08→			
35.360 FFDAK, FFHDLK	265 kW		06/08→			
35.360 FFDC, FFDLC, FDNLC	265 kW		06/08→			
35.360 FFDK, FFDLK, FFDRK	265 kW		08/08→			
35.360 FFD-TM	265 kW		10/07→			
35.360 FFNLC	265 kW		06/08→			
35.400 FFDAK	294 kW		06/08→			
35.400 FFDAK, FFDHLK	294 kW		06/08→			
35.400 FFDC, FFDLC, FDNLC	294 kW		06/08→			
35.400 FFDK, FFDLK, FFDRK	294 kW		08/08→			
35.400 FFD-TM	294 kW		10/07→			
35.400 FFNHLK	294 kW		10/07→			
35.400 FFNLC	294 kW		06/08→			
35.440 FDNLC, FFDC, FFDLC, FFNLC	324 kW		06/08→			
35.440 FFDAK	324 kW		06/08→			
35.440 FFDAK, FFDHLK	324 kW		06/08→			
35.440 FFDK, FFDLK, FFDRK	324 kW		08/08→			
35.440 FFD-TM	324 kW		10/07→			
35.440 FFNHLK	324 kW		10/07→			
35.440 FFNLC	324 kW		06/08→			
35.480 FDNLC, FFDC, FFDLC	353 kW		06/08→			
35.480 FFDAK	353 kW		06/08→			
35.480 FFDAK, FFDHLK	353 kW		06/08→			
35.480 FFDK, FFDLK, FFDRK	353 kW		08/08→			
35.480 FFD-TM	353 kW		10/07→			
35.480 FFNHLK	353 kW		10/07→			
35.480 FFNLC	353 kW		06/08→			
35.540 FDNLC, FFDC, FFDLC	397 kW		06/08→			
35.540 FFDAK	397 kW		02/09→			
35.540 FFDAK, FFDHLK	397 kW		02/09→			
35.540 FFDK, FFDLK, FFDRK	397 kW		02/09→			
35.540 FFD-TM	397 kW		10/07→			
35.540 FFNLC	397 kW		02/09→			
37.320 FFDC	235 kW		07/08→			
37.320 FFDK	235 kW		07/08→			
37.320 FFD-TM	235 kW		10/07→			
37.360 FFDC	265 kW		07/08→			
37.360 FFDK	265 kW		07/08→			
37.360 FFD-TM	265 kW		10/07→			
37.400 FFDC	294 kW		07/08→			
37.400 FFDK	294 kW		07/08→			
37.400 FFD-TM	294 kW		10/07→			
37.440 FFDC	324 kW		07/08→			
37.440 FFDK	324 kW		07/08→			
37.440 FFD-TM	324 kW		10/07→			
37.480 FFDC	353 kW		07/08→			
37.480 FFDK	353 kW		07/08→			
37.480 FFD-TM	353 kW		10/07→			
37.540 FFDC	397 kW		02/09→			
37.540 FFDK	397 kW		02/09→			
37.540 FFD-TM	397 kW		10/07→			
40.400 FDAK-WW, FDARK-WW	294 kW		02/11→			
40.400 FDAS-WW, FDARS-WW	294 kW		02/11→			
40.440 FDAK-WW, FDARK-WW	324 kW		02/11→			
40.440 FDAS-WW, FDARS-WW	324 kW		02/11→			
41.320 FFDAK	235 kW		06/08→			
41.360 FFDAK	265 kW		06/08→			
41.360 FFDC	265 kW		07/08→			
41.360 FFDK	265 kW		07/08→			
41.360 FFD-TM	265 kW		10/07→			
41.400 FFDC	294 kW		07/08→			
41.400 FFDK	294 kW		07/08→			
41.400 FFD-TM	294 kW		10/07→			
41.440 FFDAK	324 kW		06/08→			
41.440 FFDC	324 kW		07/08→			
41.440 FFDK	324 kW		07/08→			
41.440 FFD-TM	324 kW		10/07→			
41.480 FFDAK	353 kW		06/08→			
41.480 FFDARC	353 kW		06/08→			
41.480 FFDC	353 kW		07/08→			
41.480 FFDK	353 kW		07/08→			
41.480 FFD-TM	353 kW		10/07→			
41.540 FFDAK	397 kW		02/09→			
41.540 FFDC	397 kW		02/09→			
41.540 FFDK	397 kW		02/09→			
41.540 FFD-TM	397 kW		10/07→			

Manufacturer - Model	Power	Displ.	Year of Constr.	Remark	Part Number	Page
MAN - TGX						09/07→
18.360 FHLC	265 kW		10/07→	for construction site vehicles; W5W / H7 / H7; Left; Number of light functions: 3; with bulbs; for vehicles without headlamp levelling	1EH 354 984-011 Headlight	16
18.360 FHLS, FHLS/M	265 kW		10/07→			
18.360 FLC, FLRC, FLLC, FLLRC, FLLW, FLLW/N	265 kW		10/07→	for construction site vehicles; W5W / H7 / H7; Right; Number of light functions: 3; with bulbs; for vehicles without headlamp levelling	1EH 354 984-021 Headlight	16
18.360 FLS, FLS/M, FLRS, FLRS/N, FLLS, FLLS/N, FLLRS, FLLRS/N	265 kW		10/07→	for construction site vehicles; W5W / H7 / H7; Left; Number of light functions: 3; with bulbs; for vehicles with headlamp levelling (electric)	1EH 354 984-031 Headlight	17
18.400 FHLC	294 kW		10/07→			
18.400 FHLS, FHLS/M	294 kW		10/07→			
18.400 FLC, FLRC, FLLC, FLLRC, FLLW, FLLW/N	294 kW		10/07→	for construction site vehicles; W5W / H7 / H7; Right; Number of light functions: 3; with bulbs; for vehicles with headlamp levelling (electric)	1EH 354 984-041 Headlight	17
18.400 FLS, FLS/M, FLRS, FLRS/N, FLLS, FLLS/N, FLLRS, FLLRS/N	294 kW		10/07→	H7 / H7 / PY21W; Left; Number of light functions: 4; with bulbs; for vehicles without headlamp levelling	1EH 354 987-011 Headlight	17
18.440 FHLC	324 kW		10/07→			
18.440 FHLS, FHLS/M	324 kW		10/07→			
18.440 FLC, FLRC, FLLC, FLLRC, FLLW, FLLW/N	324 kW		10/07→	H7 / H7 / PY21W; Right; Number of light functions: 4; with bulbs; for vehicles without headlamp levelling	1EH 354 987-021 Headlight	18
18.440 FLRC	324 kW		10/07→			
18.440 FLRS	324 kW		10/07→			
18.440 FLS, FLS/M, FLRS, FLRS/M, FLLS, FLLS/N, FLLRS, FLLRS/	324 kW		10/07→	H7 / H7 / PY21W; Left; Number of light functions: 4; with bulbs; for vehicles with headlamp levelling (electric)	1EH 354 987-051 Headlight	18
18.480 FHLC	353 kW		10/07→			
18.480 FHLS, FHLS/M	353 kW		10/07→			
18.480 FLC, FLRC, FLLC, FLLRC, FLLW, FLLW/N	353 kW		10/07→	H7 / H7 / PY21W; Right; Number of light functions: 4; with bulbs; for vehicles with headlamp levelling (electric)	1EH 354 987-061 Headlight	19
18.480 FLS, FLS/M, FLRS, FLRS/N, FLLS, FLLS/N, FLLRS, FLLRS/N	353 kW		10/07→	H4; Left; 24 V; with bulbs	1FP 354 986-011 Spotlight	5, 23
18.540 FHLC	397 kW		10/07→			
18.540 FHLS, FHLS/M	397 kW		10/07→			
18.540 FLC, FLRC, FLLC, FLLRC, FLLW, FLLW/N	397 kW		10/07→	H4; Left; 24 V; with bulbs	1FP 354 986-011 Fog Light	5, 23
18.540 FLS, FLS/M, FLRS, FLRS/N, FLLS, FLLS/N, FLLRS, FLLRS/N	397 kW		10/07→	H4; Right; 24 V; with bulbs	1FP 354 986-021 Spotlight	5, 23
18.540 FLS, FLS/M, FLRS, FLRS/N, FLLS, FLLS/N, FLLRS, FLLRS/N	397 kW		10/07→	H4; Right; 24 V; with bulbs	1FP 354 986-021 Fog Light	5, 23
18.540 FLS, FLS/M, FLRS, FLRS/N, FLLS, FLLS/N, FLLRS, FLLRS/N	397 kW		10/07→	H7 / H7 / PY21W; Left; Number of light functions: 4; with bulbs; for vehicles with headlamp levelling (electric)	1LH 354 987-071 Headlight	20
18.680 FLS	500 kW		10/07→			
24.360 FNLLW/N	265 kW		10/07→	H7 / H7 / PY21W; Right; Number of light functions: 4; with bulbs; for vehicles with headlamp levelling (electric)	1LH 354 987-081 Headlight	21
24.360 FPLS, FPLRS	265 kW		10/07→	for construction site vehicles; P21W / H4; Left; Yellow; with indicator / with high beam / with fog light; Number of light functions: 3; with bulbs	1NB 354 986-031 Spotlight	5, 23
24.400 FNLLW/N	294 kW		10/07→			
24.400 FPLS, FPLRS	294 kW		10/07→	for construction site vehicles; P21W / H4; Left; Yellow; with indicator / with high beam / with fog light; Number of light functions: 3; with bulbs	1NB 354 986-031 Fog Light	5, 23
24.440 FNLLW/N	324 kW		10/07→			
24.440 FPLRS	324 kW		10/07→	for construction site vehicles; P21W / H4; Right; Yellow; with indicator / with high beam / with fog light; Number of light functions: 3; with bulbs	1NB 354 986-041 Spotlight	6, 24
24.440 FPLS, FPLRS	324 kW		10/07→			
24.480 FNLLW/N	353 kW		10/07→			
24.480 FPLS, FPLRS	353 kW		10/07→			
24.540 FNLLW/N	397 kW		02/09→			
24.540 FPLS, FPLRS	397 kW		10/07→	for construction site vehicles; P21W / H4; Right; Yellow; with indicator / with high beam / with fog light; Number of light functions: 3; with bulbs	1NB 354 986-041 Fog Light	6, 24
26.320 FNLS, FNLLS	235 kW		10/07→			
26.360 FDC, FDLC, FDRC, FDLRC	265 kW		07/08→			
26.360 FDHLC	265 kW		10/07→	for construction site vehicles; H4 / PY21W; Left; White; with indicator / with high beam / with fog light; Number of light functions: 3; with bulbs	1NB 354 986-051 Spotlight	6, 24
26.360 FDHLS	265 kW		10/07→			
26.360 FDS, FDLS, FDRS, FDLRS	265 kW		07/08→			
26.360 FNHLC	265 kW		10/07→	for construction site vehicles; H4 / PY21W; Left; White; with indicator / with high beam / with fog light; Number of light functions: 3; with bulbs	1NB 354 986-051 Fog Light	6, 24
26.360 FNHLS	265 kW		12/07→			
26.360 FNLC, FNLC, FNLLC, FNLLRC, FNLLW	265 kW		10/07→			
26.360 FNLS, FNLLS, FNLRs, FNLLRS, FPLS, FPLRS, FVLS	265 kW		10/07→	for construction site vehicles; H4 / PY21W; Right; White; with indicator / with high beam / with fog light; Number of light functions: 3; with bulbs	1NB 354 986-061 Spotlight	6, 24
26.360 FVHLS	265 kW		05/08→			
26.400 FDC, FDLC, FDRC, FDLRC	294 kW		07/08→	for construction site vehicles; H4 / PY21W; Right; White; with indicator / with high beam / with fog light; Number of light functions: 3; with bulbs	1NB 354 986-061 Fog Light	6, 24
26.400 FDHLC	294 kW		10/07→			
26.400 FDHLS	294 kW		10/07→			
26.400 FDS, FDLS, FDRS, FDLRS	294 kW		07/08→	Front; White; Number of light functions: 1	2PF 354 985-011 Position Light	45
26.400 FNHLC	294 kW		12/07→			
26.400 FNHLS	294 kW		12/07→	Yellow; LED; Number of light functions: 1	2PS 354 985-001 Side Marker Light	45
26.400 FNLC, FNLC, FNLLC, FNLLRC, FNLLW	294 kW		10/07→	for construction site vehicles; Left; without gasket / seal	9ES 354 984-051 Diffusing Lens, headlight	4
26.400 FNLS, FNLLS, FNLRs, FNLLRS, FPLS, FPLRS, FVLS	294 kW		10/07→	for construction site vehicles; Right; without gasket / seal	9ES 354 984-061 Diffusing Lens, headlight	4
26.400 FPHLS	294 kW		05/08→			
26.400 FVHLS	294 kW		05/08→	Left; without gasket / seal	9ES 354 987-091 Diffusing Lens, headlight	4
26.440 FDC, FDLC, FDRC, FDLRC	324 kW		07/08→			
26.440 FDHLC	324 kW		09/07→			
26.440 FDHLS	324 kW		10/07→	Right; without gasket / seal	9ES 354 987-101 Diffusing Lens, headlight	4

Manufacturer - Model	Power	Displ.	Year of Constr.	Remark	Part Number	Page
MAN - TGX						09/07→
26.440 FDS, FDLS, FDRS, FDLRS	324 kW		07/08→	for construction site vehicles; W5W / H7 / H7; Left; Number of light functions: 3; with bulbs; for vehicles without headlamp levelling	1EH 354 984-011 Headlight	16
26.440 FNHLC	324 kW		12/07→			
26.440 FNHLS	324 kW		12/07→	for construction site vehicles; W5W / H7 / H7; Right; Number of light functions: 3; with bulbs; for vehicles without headlamp levelling	1EH 354 984-021 Headlight	16
26.440 FNLC, FNLC, FNLLC, FNLLRC, FNLLW	324 kW		10/07→			
26.440 FNLS, FNLLS, FNLRs, FNLLRS, FPLS, FPLRS, FVLS	324 kW		10/07→	for construction site vehicles; W5W / H7 / H7; Left; Number of light functions: 3; with bulbs; for vehicles with headlamp levelling (electric)	1EH 354 984-031 Headlight	17
26.440 FPHLS	324 kW		05/08→			
26.440 FPLRS	324 kW		07/08→	for construction site vehicles; W5W / H7 / H7; Right; Number of light functions: 3; with bulbs; for vehicles with headlamp levelling (electric)	1EH 354 984-041 Headlight	17
26.440 FVHLS	324 kW		05/08→			
26.480 FDC, FDLC, FDRC, FDLRC	353 kW		07/08→	H7 / H7 / PY21W; Left; Number of light functions: 4; with bulbs; for vehicles without headlamp levelling	1EH 354 987-011 Headlight	17
26.480 FDHLC	353 kW		09/07→			
26.480 FDHLS	353 kW		10/07→	H7 / H7 / PY21W; Right; Number of light functions: 4; with bulbs; for vehicles without headlamp levelling	1EH 354 987-021 Headlight	18
26.480 FDS, FDLS, FDRS, FDLRS	353 kW		07/08→			
26.480 FNHLC	353 kW		12/07→	H7 / H7 / PY21W / H21 W; Left; Number of light functions: 5; with bulbs; for vehicles without headlamp levelling	1EH 354 987-031 Headlight	18
26.480 FNHLS	353 kW		12/07→			
26.480 FNLC, FNLC, FNLLC, FNLLRC, FNLLW	353 kW		10/07→	H7 / H7 / PY21W; Left; Number of light functions: 4; with bulbs; for vehicles with headlamp levelling (electric)	1EH 354 987-051 Headlight	18
26.480 FNLS, FNLLS, FNLRs, FNLLRS, FPLS, FPLRS, FVLS	353 kW		10/07→			
26.480 FPHLS	353 kW		05/08→	H7 / H7 / PY21W; Right; Number of light functions: 4; with bulbs; for vehicles with headlamp levelling (electric)	1EH 354 987-061 Headlight	19
26.480 FVHLS	353 kW		05/08→			
26.540 FDC, FDLC, FDRC, FDLRC	397 kW		02/09→	H4; Left; 24 V; with bulbs	1FP 354 986-011 Spotlight	5, 23
26.540 FDS, FDLS, FDRS, FDLRS	397 kW		02/09→	H4; Left; 24 V; with bulbs	1FP 354 986-011 Fog Light	5, 23
26.540 FNLC, FNLC, FNLLC, FNLLRC, FNLLW	397 kW		10/07→	H4; Right; 24 V; with bulbs	1FP 354 986-021 Spotlight	5, 23
26.540 FNLS, FNLRs, FNLLS, FPLS, FPLRS, FVLS	397 kW		10/07→	H4; Right; 24 V; with bulbs	1FP 354 986-021 Fog Light	5, 23
28.360 FNLC	265 kW		10/07→			
28.360 FNLS	265 kW		10/07→	H7 / H7 / PY21W; Left; Number of light functions: 4; with bulbs; for vehicles with headlamp levelling (electric)	1LH 354 987-071 Headlight	20
28.400 FNLC	294 kW		10/07→			
28.400 FNLS	294 kW		10/07→			
28.440 FNLC	324 kW		10/07→	H7 / H7 / PY21W; Right; Number of light functions: 4; with bulbs; for vehicles with headlamp levelling (electric)	1LH 354 987-081 Headlight	21
28.440 FNLS	324 kW		10/07→			
28.480 FNLC	353 kW		10/07→			
28.480 FNLS	353 kW		10/07→	for construction site vehicles; P21W / H4; Left; Yellow; with indicator / with high beam / with fog light; Number of light functions: 3; with bulbs	1NB 354 986-031 Spotlight	5, 23
28.540 FNLC	397 kW		10/07→			
28.540 FNLS	397 kW		02/09→	for construction site vehicles; P21W / H4; Left; Yellow; with indicator / with high beam / with fog light; Number of light functions: 3; with bulbs	1NB 354 986-031 Fog Light	5, 23
33.360 FDC, FDC/M, FDLC	265 kW		10/07→			
33.360 FDS, FDS/M, FDLS, FDLS/M	265 kW		10/07→	for construction site vehicles; P21W / H4; Right; Yellow; with indicator / with high beam / with fog light; Number of light functions: 3; with bulbs	1NB 354 986-041 Spotlight	6, 24
33.400 FDC, FDC/M, FDLC	294 kW		10/07→			
33.400 FDS, FDS/M, FDLS, FDLS/M	294 kW		10/07→	for construction site vehicles; P21W / H4; Right; Yellow; with indicator / with high beam / with fog light; Number of light functions: 3; with bulbs	1NB 354 986-041 Fog Light	6, 24
33.440 FDC, FDC/M, FDLC	324 kW		10/07→			
33.440 FDS, FDS/M, FDLS, FDLS/M	324 kW		10/07→	for construction site vehicles; H4 / PY21W; Left; White; with indicator / with high beam / with fog light; Number of light functions: 3; with bulbs	1NB 354 986-051 Spotlight	6, 24
33.480 FDC, FDC/M, FDLC	353 kW		10/07→			
33.480 FDS, FDS/M, FDLS, FDLS/M	353 kW		10/07→	for construction site vehicles; H4 / PY21W; Left; White; with indicator / with high beam / with fog light; Number of light functions: 3; with bulbs	1NB 354 986-051 Fog Light	6, 24
33.540 FDC, FDC/M, FDLC	397 kW		10/07→			
33.540 FDS, FDS/M, FDLS, FDLS/M	397 kW		10/07→	for construction site vehicles; H4 / PY21W; Left; White; with indicator / with high beam / with fog light; Number of light functions: 3; with bulbs	1NB 354 986-051 Fog Light	6, 24
33.680 FDLC	500 kW		10/07→			
33.680 FDLS	500 kW		10/07→			
35.360 FDNLC	265 kW		06/08→	for construction site vehicles; H4 / PY21W; Right; White; with indicator / with high beam / with fog light; Number of light functions: 3; with bulbs	1NB 354 986-061 Spotlight	6, 24
35.400 FDNLC	294 kW		06/08→			
35.440 FDNLC	324 kW		06/08→			
35.480 FDNLC	353 kW		06/08→	for construction site vehicles; H4 / PY21W; Right; White; with indicator / with high beam / with fog light; Number of light functions: 3; with bulbs	1NB 354 986-061 Fog Light	6, 24
35.540 FDNLC	397 kW		06/08→			
41.540 FVDS, FVDLS	397 kW		06/08→			
41.680 FVDS, FVDLS	500 kW		10/07→	Front; White; Number of light functions: 1	2PF 354 985-011 Position Light	45
				Yellow; LED; Number of light functions: 1	2PS 354 985-001 Side Marker Light	45
				for construction site vehicles; Left; without gasket / seal	9ES 354 984-051 Diffusing Lens, headlight	4
				for construction site vehicles; Right; without gasket / seal	9ES 354 984-061 Diffusing Lens, headlight	4
				Left; without gasket / seal	9ES 354 987-091 Diffusing Lens, headlight	4
				Right; without gasket / seal	9ES 354 987-101 Diffusing Lens, headlight	4

Manufacturer - Model	Power	Displ.	Year of Constr.	Remark	Part Number	Page
MAN - ÜL						09/89→
ÜL 242	177 kW		09/89→03/93	H3; Left / Right; Number of light functions: 1; 24 V	1NB 003 367-137 Fog Light	5
ÜL 292	213 - 222 kW		09/89→03/93			
ÜL 313	228 kW		09/96→	H1 / T4W; Left; Number of light functions: 2; 12 V / 24 V	1BL 005 740-091 Insert, 29 headlight	29
ÜL 353	257 kW		06/97→	H1 / T4W; Right; Number of light functions: 2; 12 V / 24 V	1BL 005 740-101 Insert, 30 headlight	30
				H1; Depth [mm]: 140; Three-point mounting; Fitting Depth [mm]: 133; Left; Inner Diameter [mm]: 120; Manufacturer Restriction: Ref. 27,5; Number of light functions: 1; 12 V / 24 V	1FE 005 478-011 Spotlight	22
				H1; Depth [mm]: 140; Three-point mounting; Fitting Depth [mm]: 133; Right; Inner Diameter [mm]: 120; for main beam / with high beam; Manufacturer Restriction: Ref. 27,5; Number of light functions: 1; 12 V / 24 V	1FE 005 478-021 Spotlight	23
				P21W; Left / Right / Front; Yellow; Number of light functions: 1; with lamp base	2BA 005 603-001 Indicator	46
				C5W; Left / Right; Number of light functions: 1; with lamp base	2KA 001 388-051 Licence Plate Light	44

1A8 ...		2XS ...	
1A8 003 060-541	8	2XS 005 020-041	45
1A8 003 060-551	9	9BG ...	
1A8 121 149-001	28	9BG 121 587-031	27
1A8 121 150-001	28	9BG 130 945-001	26
1AG ...		9BG 130 946-001	26
1AG 003 434-211	10	9EL ...	
1AG 003 434-251	11	9EL 122 689-021	31
1BL ...		9EL 122 689-051	32
1BL 005 740-091	29	9EL 132 215-011	33
1BL 005 740-101	30	9EL 147 747-001	32
1D3 ...		9EL 152 889-001	33
1D3 009 027-011	12	9ES ...	
1D3 009 027-021	13	9ES 120 743-001	4
1D3 009 027-031	14	9ES 354 984-051	4
1D3 009 027-041	14	9ES 354 984-061	4
1EF ...		9ES 354 987-091	4
1EF 354 340-011	15	9ES 354 987-101	4
1EF 354 340-021	16		
1EH ...			
1EH 354 984-011	16		
1EH 354 984-021	16		
1EH 354 984-031	17		
1EH 354 984-041	17		
1EH 354 987-011	17		
1EH 354 987-021	18		
1EH 354 987-031	18		
1EH 354 987-051	18		
1EH 354 987-061	19		
1FE ...			
1FE 005 478-011	22		
1FE 005 478-021	23		
1FP ...			
1FP 354 986-011	5, 23		
1FP 354 986-021	5, 23		
1G4 ...			
1G4 004 480-001	25		
1L8 ...			
1L8 003 060-561	19		
1L8 003 060-691	20		
1LH ...			
1LH 354 987-071	20		
1LH 354 987-081	21		
1NB ...			
1NB 003 367-137	5		
1NB 354 986-031	5, 23		
1NB 354 986-041	6, 24		
1NB 354 986-051	6, 24		
1NB 354 986-061	6, 24		
1NB 354 986-071	6, 24		
1NB 354 986-081	6, 24		
1NE ...			
1NE 006 300-051	7		
2BA ...			
2BA 005 603-001	46		
2BA 007 839-001	46		
2BA 007 840-001	47		
2BM ...			
2BM 006 692-011	47		
2BM 006 692-021	48		
2KA ...			
2KA 001 388-051	44		
2KA 003 389-081	44		
2PF ...			
2PF 354 985-011	45		
2PF 354 985-021	45		
2PS ...			
2PS 354 985-001	45		
2SD ...			
2SD 003 167-531	34		
2SD 003 167-541	35		
2VD ...			
2VD 008 204-051	36		
2VD 008 204-071	37		
2VD 008 204-251	38		
2VP ...			
2VP 003 567-111	39		
2VP 003 567-121	40		
2VP 008 204-041	41		
2VP 008 204-061	42		
2VP 008 204-241	43		



Water Pump, headlight cleaning.....	110
Water Pump, window cleaning.....	111
Wiper Blade.....	112

Pump - Water Pump, headlight cleaning

8TW 004 764-041
089310

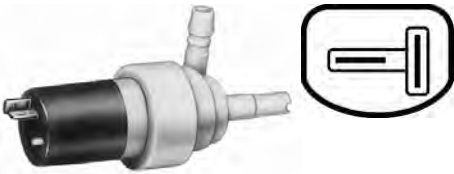

Delivery Quantity [l/h]	432
Operating Mode	Electric
Plug Type	Blade Terminal
Pressure [bar]	2.5
Pressure hose connector diameter [mm]	11
Pump Type	Mono Pump
Rated Voltage [V]	24
Suction pipe connector diameter [mm]	10.5

8TW 007 540-037



Delivery Quantity [l/h]	432
Housing Diameter [mm]	35
Operating Mode	Electric
Pressure [bar]	2.5
Pressure hose connector diameter [mm]	11
Pump Type	Mono Pump
Quantity	32
Rated Voltage [V]	24
Suction pipe connector diameter [mm]	10.5

Pump - Water Pump, window cleaning

8TW 006 849-091



Operating Mode	Electric
Pump Type	Mono Pump
Rated Voltage [V]	24
Supplementary Article/Supplementary Info 2	with sensor for washwater level

Wiper Blade

9XW 184 107-201
WT 20



Driver Position	for left-hand drive vehicles
Fitting Position	Front
Left-hand / Right-hand Traffic	for right-hand traffic
Length [mm]	500
Quantity	1

9XW 184 107-241
WT 24

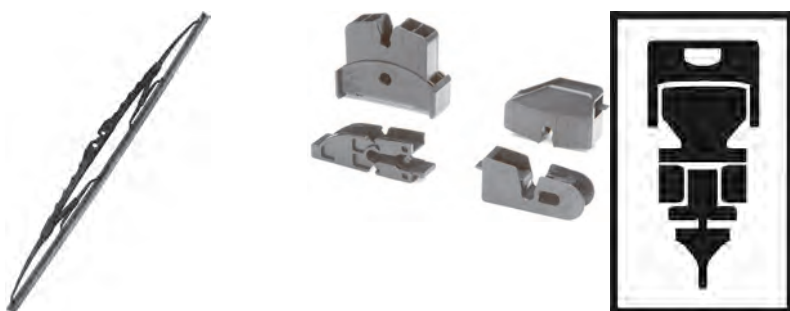

Driver Position	for left-hand drive vehicles
Fitting Position	Front
Left-hand / Right-hand Traffic	for right-hand traffic
Length [mm]	600
Quantity	1

9XW 184 107-281
WT 28



Driver Position	for left-hand drive vehicles
Fitting Position	Front
Left-hand / Right-hand Traffic	for right-hand traffic
Length [mm]	700
Quantity	1

Wiper Blade

9XW 184 107-321
WT 32



Driver Position	for left-hand drive vehicles
Fitting Position	Front
Left-hand / Right-hand Traffic	for right-hand traffic
Length [mm]	800
Quantity	1

9XW 184 107-361
WT 36



Driver Position	for left-hand drive vehicles
Fitting Position	Front
Left-hand / Right-hand Traffic	for right-hand traffic
Length [mm]	900
Quantity	1

9XW 184 107-401
WT 40



Driver Position	for left-hand drive vehicles
Fitting Position	Front
Left-hand / Right-hand Traffic	for right-hand traffic
Length [mm]	1,000
Quantity	1

Wiper Blade

9XW 191 397-201
WTR 20



Driver Position	for right-hand drive vehicles
Fitting Position	Front
Left-hand / Right-hand Traffic	for left-hand traffic
Length [in]	20
Length [mm]	500
Quantity	1

9XW 191 397-241
WTR 24

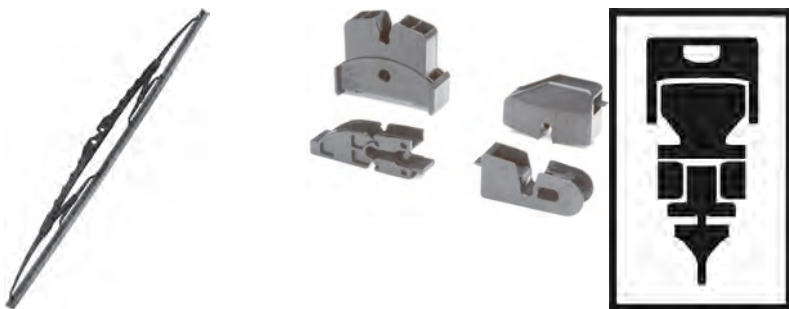

Driver Position	for right-hand drive vehicles
Fitting Position	Front
Left-hand / Right-hand Traffic	for left-hand traffic
Length [in]	24
Length [mm]	600
Quantity	1

Wiper Blade

9XW 191 397-281
WTR 28

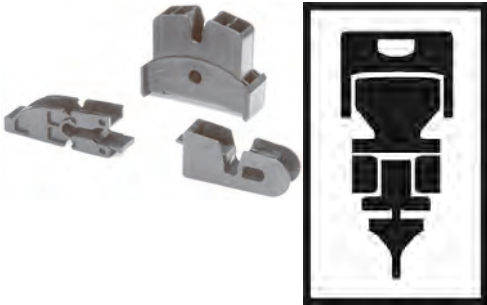

Driver Position	for right-hand drive vehicles
Fitting Position	Front
Left-hand / Right-hand Traffic	for left-hand traffic
Length [in]	28
Length [mm]	700
Quantity	1

9XW 191 397-321
WTR 32



Driver Position	for right-hand drive vehicles
Fitting Position	Front
Left-hand / Right-hand Traffic	for left-hand traffic
Length [in]	32
Length [mm]	800
Quantity	1

Wiper Blade

9XW 191 397-361
WTR 36



Driver Position	for right-hand drive vehicles
Fitting Position	Front
Left-hand / Right-hand Traffic	for left-hand traffic
Length [in]	36
Length [mm]	900
Quantity	1

9XW 191 397-401
WTR 40



Driver Position	for right-hand drive vehicles
Fitting Position	Front
Left-hand / Right-hand Traffic	for left-hand traffic
Length [in]	40
Length [mm]	1,000
Quantity	1

Wiper Blade

9XW 194 562-361
WT 36A



Driver Position	for left-hand drive vehicles
Fitting Position	Front
Left-hand / Right-hand Traffic	for right-hand traffic
Length [in]	36
Length [mm]	900
Quantity	1

9XW 194 562-401
WT 40A



Driver Position	for left-hand drive vehicles
Fitting Position	Front
Left-hand / Right-hand Traffic	for right-hand traffic
Length [in]	40
Length [mm]	1,000
Quantity	1

Wiper Blade

9XW 862 050-001
NB 400, 095071

HELLA



Driver Position	for left-hand drive vehicles
Fitting Position	Front
Left-hand / Right-hand Traffic	for right-hand traffic
Length [mm]	400
Length 1 [mm]	400
Quantity	1

9XW 862 052-001
NB 500, 095073

HELLA



Driver Position	for left-hand drive vehicles
Fitting Position	Front
Left-hand / Right-hand Traffic	for right-hand traffic
Length [mm]	500
Length 1 [mm]	500
Quantity	1

Wiper Blade

9XW 862 056-001
NB 600, 095077

HELLA



Driver Position	for left-hand drive vehicles
Fitting Position	Front
Left-hand / Right-hand Traffic	for right-hand traffic
Length [mm]	600
Length 1 [mm]	600
Quantity	1

9XW 862 061-001
095082, NB 900

HELLA



Driver Position	for left-hand drive vehicles
Fitting Position	Front
Left-hand / Right-hand Traffic	for right-hand traffic
Length [mm]	900
Length 1 [mm]	900
Quantity	1



MAN.....121

Manufacturer - Model	Power	Displ.	Year of Constr.	Remark	Part Number	Page
MAN - Cab-over Trucks						07/86→05/94
19.322 U, 19.322 UL, 19.322 ULL	235 kW		02/90→05/94	Front; L 600 mm; Quantity: 1	9XW 184 107-241 Wiper 112 Blade	
19.332 U, 19.322 UL, 19.322 ULL	243 kW		07/86→02/90			
19.362 U, 19.362 UL, 19.362 ULL	265 kW		07/86→01/91	Front; Length [in]: 24; L 600 mm; Quantity: 1	9XW 191 397-241 Wiper 114 Blade	
19.372 U, 19.372 ULL	272 kW		02/90→05/94			
19.422 U, 19.422 ULL	309 kW		02/90→05/94	Front; Length 1 [mm]: 600; Quantity: 1	9XW 862 056-001 Wiper 119 Blade	
24.322 UNL, 24.322 UNLL	235 kW		02/90→12/90			
24.332 UNL, 24.332 UNLL	243 kW		10/86→02/90			
24.362 UNL, 24.362 UNLL	265 kW		10/86→02/90			
24.372 UNL, 24.372 UNLL	272 kW		02/90→12/90			
24.422 UNL, 24.422 UNLL	309 kW		02/90→12/90			
25.322 UNL, 25.322 UNLL	235 kW		09/90→12/92			
25.372 UNL, 25.372 UNLL	272 kW		09/90→12/92			
25.422 UNL, 25.422 UNLL	309 kW		09/90→12/92			
26.322 UNL, 26.322 UNLL	235 kW		09/90→05/94			
26.372 UNL, 26.372 UNLL	272 kW		09/90→05/94			
26.422 UNL, 26.422 UNLL	309 kW		09/90→05/94			
MAN - E 2000						05/00→
19.310 FALK	228 kW		05/00→	Front; L 600 mm; Quantity: 1	9XW 184 107-241 Wiper 112 Blade	
19.310 FALS	228 kW		05/00→			
19.310 FLK	228 kW		05/00→			
19.310 FLS	228 kW		05/00→			
19.360 FALK	265 kW		05/00→			
19.360 FALS	265 kW		05/00→			
19.360 FLK	265 kW		05/00→			
19.360 FLS	265 kW		05/00→			
19.410 FALK	301 kW		05/00→			
19.410 FALS	301 kW		05/00→			
19.410 FLK	301 kW		05/00→			
19.410 FLS	301 kW		05/00→			
19.460 FALK	338 kW		05/00→			
19.460 FALS	338 kW		05/00→			
19.460 FLK	338 kW		05/00→			
19.460 FLS	338 kW		05/00→			
26.310 FAVLC	228 kW		05/00→			
26.310 FAVLK	228 kW		05/00→			
26.360 FAVLC	265 kW		05/00→			
26.360 FAVLK	265 kW		05/00→			
26.410 DFARC	301 kW		05/00→			
26.410 DFRC, FAVLC	301 kW		05/00→			
26.410 FAVLK	301 kW		05/00→			
26.460 DFARC	338 kW		05/00→			
26.460 DFLRS	338 kW		05/00→			
26.460 FAVLC	338 kW		05/00→			
26.460 FAVLK	338 kW		05/00→			
28.230 FNLC	170 kW		05/00→			
28.310 FNLC	228 kW		05/00→			
28.360 FANLC	265 kW		05/00→			
28.360 FANLK	265 kW		05/00→			
28.360 FNALC	265 kW		05/00→			
28.360 FNLC	265 kW		05/00→			
28.410 FANLC	301 kW		05/00→			
28.410 FANLK	301 kW		05/00→			
28.410 FNLC	301 kW		05/00→			
28.460 FANLC	338 kW		05/00→			
28.460 FANLK	338 kW		05/00→			
28.460 FNLC	338 kW		05/00→			
29.460 FVAS	338 kW		05/00→			
30.310 FNLC	228 kW		05/00→			
30.360 FANLC	265 kW		05/00→			
30.360 FANLK	265 kW		05/00→			
30.360 FNLC	265 kW		05/00→			
30.410 FANLC	301 kW		05/00→			
30.410 FANLK	301 kW		05/00→			
30.410 FNLC	301 kW		05/00→			
30.460 FANLC	338 kW		05/00→			
30.460 FANLK	338 kW		05/00→			
30.460 FNLC	338 kW		05/00→			
32.310 VFCL	228 kW		05/00→			
32.310 VFNLCL	228 kW		05/00→			
32.360 VFCL	265 kW		05/00→			
32.360 VFNLCL	265 kW		05/00→			
32.410 VFARK	301 kW		05/00→			
32.410 VFCL, VFRC, VFRLC	301 kW		05/00→			
32.410 VFNLCL	301 kW		05/00→			
32.460 VFCL, VFRLC	338 kW		05/00→			
32.460 VFNLCL	338 kW		05/00→			
33.360 DFAK, DFALK	265 kW		05/00→			
33.360 DFALC	265 kW		05/00→			
33.360 DFALS	265 kW		04/01→			

Manufacturer - Model	Power	Displ.	Year of Constr.	Remark	Part Number	Page
MAN - E 2000						05/00→
33.360 DFLC	265 kW		05/00→	Front; L 600 mm; Quantity: 1	9XW 184 107-241 Wiper 112 Blade	
33.360 DFLK	265 kW		05/00→			
33.360 DFSL	265 kW		05/00→			
33.410 DFAK, DFALK	301 kW		05/00→			
33.410 DFALC	301 kW		05/00→			
33.410 DFALS	301 kW		04/01→			
33.410 DFLC	301 kW		05/00→			
33.410 DFLK	301 kW		05/00→			
33.410 DFSL	301 kW		05/00→			
33.460 DFAK, DFALK	338 kW		05/00→			
33.460 DFALC	338 kW		05/00→			
33.460 DFALS	338 kW		04/01→			
33.460 DFLC	338 kW		05/00→			
33.460 DFLK	338 kW		05/00→			
33.460 DFSL	338 kW		05/00→			
33.600 DFALS, DFAS	441 kW		06/00→			
33.600 DFSL	441 kW		06/00→			
35.360 VFAK	265 kW		05/00→			
35.410 FVNLC	301 kW		05/00→			
35.410 VFAK	301 kW		05/00→			
35.460 FVNLC	338 kW		05/00→			
35.460 VFAK	338 kW		05/00→			
40.600 DFAS	441 kW		06/00→			
41.360 VFAK	265 kW		05/00→			
41.410 VFAK	301 kW		05/00→			
41.460 DFVS, DFVLS	338 kW		06/00→			
41.460 VFAK	338 kW		05/00→			
41.600 DFVS, DFVLS	441 kW		06/00→			
50.410 VFAK	301 kW		05/00→			
50.410 VFAVK, VFAV-G	301 kW		03/01→			
50.410 VFK	301 kW		05/00→			
50.410 VFVK, VFV-G	301 kW		10/00→			
50.460 VFAK	338 kW		05/00→			
50.460 VFAVK, VFAV-G	338 kW		03/01→			
50.460 VFK	338 kW		05/00→			
50.460 VFVK, VFV-G	338 kW		10/00→			
50.600 VFAS	441 kW		05/00→			
MAN - EL						01/93→
EL 202,EL 222	157 - 169 kW		01/93→06/97	Front; L 900 mm; Quantity: 1	9XW 184 107-361 Wiper 113 Blade	
EL 202,EL 262	184 kW		04/94→06/97			
				Front; Length [in]: 36; L 900 mm; Quantity: 1	9XW 191 397-361 Wiper 116 Blade	
				Front; Length [in]: 36; L 900 mm; Quantity: 1	9XW 194 562-361 Wiper 117 Blade	
				Front; Length 1 [mm]: 900; Quantity: 1	9XW 862 061-001 Wiper 119 Blade	
EL 262	191 kW		07/98→	→09/01; Front; L 900 mm; Quantity: 1	9XW 184 107-361 Wiper 113 Blade	
				→09/01; Front; Length [in]: 36; L 900 mm; Quantity: 1	9XW 191 397-361 Wiper 116 Blade	
				→09/01; Front; Length [in]: 36; L 900 mm; Quantity: 1	9XW 194 562-361 Wiper 117 Blade	
				→09/01; Front; Length 1 [mm]: 900; Quantity: 1	9XW 862 061-001 Wiper 119 Blade	
MAN - EM						08/87→
EM 192	140 kW		10/93→06/97	Front; L 900 mm; Quantity: 1	9XW 184 107-361 Wiper 113 Blade	
				Front; Length [in]: 36; L 900 mm; Quantity: 1	9XW 191 397-361 Wiper 116 Blade	
				Front; Length [in]: 36; L 900 mm; Quantity: 1	9XW 194 562-361 Wiper 117 Blade	
				Front; Length 1 [mm]: 900; Quantity: 1	9XW 862 061-001 Wiper 119 Blade	
EM 222,EM 223	162 kW		02/96→	→09/01; Front; L 900 mm; Quantity: 1	9XW 184 107-361 Wiper 113 Blade	
				→09/01; Front; Length [in]: 36; L 900 mm; Quantity: 1	9XW 191 397-361 Wiper 116 Blade	
				→09/01; Front; Length [in]: 36; L 900 mm; Quantity: 1	9XW 194 562-361 Wiper 117 Blade	
				→09/01; Front; Length 1 [mm]: 900; Quantity: 1	9XW 862 061-001 Wiper 119 Blade	

Manufacturer - Model	Power	Displ.	Year of Constr.	Remark	Part Number	Page
MAN - EM						08/87→
EM 223	162 kW		08/87→	02/96→; →09/01: Front; L 900 mm; Quantity: 1	9XW 184 107-361 Wiper 113 Blade	
				02/96→; →09/01: Front; Length [in]: 36; L 900 mm; Quantity: 1	9XW 191 397-361 Wiper 116 Blade	
				02/96→; →09/01: Front; Length [in]: 36; L 900 mm; Quantity: 1	9XW 194 562-361 Wiper 117 Blade	
				02/96→; →09/01: Front; Length 1 [mm]: 900; Quantity: 1	9XW 862 061-001 Wiper 119 Blade	
MAN - F 90						07/86→
15.192 FL	141 kW			Front; L 600 mm; Quantity: 1	9XW 184 107-241 Wiper 112 Blade	
19.242 F, 19.242 FL, 19.242 FLL	177 kW		01/88→01/89			
19.242 FK	177 kW		01/88→02/89	Front; Length [in]: 24; L 600 mm; Quantity: 1	9XW 191 397-241 Wiper 114 Blade	
19.242 FS, 19.242 FLS, 19.242 FLLS	177 kW		01/88→01/89			
19.262 F, 19.262 FL, 19.262 FLL	191 kW		01/88→02/90	Front; Length 1 [mm]: 600; Quantity: 1	9XW 862 056-001 Wiper 119 Blade	
19.262 FA	191 kW		02/89→02/90			
19.262 FAK	191 kW		02/89→02/90			
19.262 FAS	191 kW		02/89→02/90			
19.262 FK	191 kW		01/88→02/90			
19.262 FS, 19.262 FLS, 19.262 FLLS	191 kW		01/88→02/90			
19.272 F, 19.272 FL, 19.272 FLL	198 kW		02/90→05/95			
19.272 FA	198 kW		02/90→05/95			
19.272 FAK	198 kW		02/90→05/95			
19.272 FAS	198 kW		02/90→05/95			
19.272 FK	198 kW		02/90→05/95			
19.272 FS, 19.272 FLS, 19.272 FLLS	198 kW		02/90→05/95			
19.292 F, 19.292 FL, 19.292 FLL	213 kW		07/86→02/90			
19.292 FA	213 kW		05/88→02/90			
19.292 FAK	213 kW		05/88→02/90			
19.292 FAS	213 kW		05/88→02/90			
19.292 FK	213 kW		07/86→02/90			
19.292 FS, 19.292 FLS, 19.292 FLLS	213 kW		07/86→02/90			
19.322 F, 19.322 FL, 19.322 FLL	235 kW		02/90→05/95			
19.322 FA	235 kW		02/90→06/96			
19.322 FAK	235 kW		02/90→06/96			
19.322 FAS	235 kW		02/90→06/96			
19.322 FK	235 kW		02/90→05/95			
19.322 FS, 19.322 FLS, 19.322 FLLS	235 kW		02/90→05/95			
19.332 F, 19.332 FL, 19.332 FLL	243 kW		07/86→02/90			
19.332 FA	243 kW		05/88→02/90			
19.332 FAK	243 kW		05/88→02/90			
19.332 FAS	243 kW		05/88→02/90			
19.332 FK	243 kW		07/86→02/90			
19.332 FS, 19.332 FLS, 19.332 FLLS	243 kW		07/86→02/90			
19.342 F, 19.342 FL, 19.342 FLL	250 kW		05/94→05/95			
19.342 FA	250 kW		05/94→06/96			
19.342 FAK	250 kW		05/94→06/96			
19.342 FAS	250 kW		05/94→06/96			
19.342 FK	250 kW		05/94→05/95			
19.342 FS, 19.342 FLS, 19.342 FLLS	250 kW		05/94→05/95			
19.362 F, 19.362 FL, 19.362 FLL	265 kW		07/86→02/90			
19.362 FA	265 kW		05/88→02/90			
19.362 FAK	265 kW		05/88→02/90			
19.362 FAS	265 kW		05/88→02/90			
19.362 FK	265 kW		07/86→02/90			
19.362 FS, 19.362 FLS, 19.362 FLLS	265 kW		07/86→02/90			
19.372 F, 19.372 FL, 19.372 FLL	249 kW		05/90→04/95			
19.372 F, 19.372 FL, 19.372 FLL	272 kW		02/90→05/95			
19.372 FA	272 kW		02/90→06/96			
19.372 FAK	272 kW		02/90→06/96			
19.372 FAS	272 kW		02/90→06/96			
19.372 FK	249 kW		05/90→04/95			
19.372 FK	272 kW		02/90→05/95			
19.372 FS, 19.372 FLS, 19.372 FLLS	249 kW		05/90→04/95			
19.372 FS, 19.372 FLS, 19.372 FLLS	272 kW		02/90→05/95			
19.402 F, 19.402 FL, 19.402 FLL	294 kW		05/94→05/95			
19.402 FA	294 kW		05/94→06/96			
19.402 FAK	294 kW		05/94→06/96			
19.402 FAS	294 kW		05/94→06/96			
19.402 FK	294 kW		05/94→05/95			

Manufacturer - Model	Power	Displ.	Year of Constr.	Remark	Part Number	Page
MAN - F 90						07/86→
19.402 FS,19.402 FLS,19.402 FLLS	294 kW		05/94→05/95	Front; L 600 mm; Quantity: 1	9XW 184 107-241 Wiper 112 Blade	
19.422 F,19.422 FL,19.422 FLL	309 kW		02/90→05/95	Front; Length [in]: 24; L 600 mm; Quantity: 1	9XW 191 397-241 Wiper 114 Blade	
19.422 FA	309 kW		02/90→06/96			
19.422 FAK	309 kW		02/90→06/96	Front; Length 1 [mm]: 600; Quantity: 1	9XW 862 056-001 Wiper 119 Blade	
19.422 FAS	309 kW		02/90→06/96			
19.422 FK	309 kW		02/90→05/95			
19.422 FS,19.422 FLS,19.422 FLLS	309 kW		02/90→05/95			
19.462 F,19.462 FL	338 kW		05/87→02/90			
19.462 FK	338 kW		05/87→02/90			
19.462 FS,19.462 FLS	338 kW		05/87→02/90			
19.502 F,19.502 FL,19.502 FLL	368 kW		02/90→06/96			
19.502 FS,19.502 FLS,19.502 FLLS	368 kW		02/90→06/96			
24.242 DF	177 kW		01/88→07/89			
24.242 DFK	177 kW		01/88→07/89			
24.242 DFS	177 kW		01/88→07/89			
24.242 FNL,24.242 FNLL,24.242 FVL	177 kW		01/88→02/90			
24.262 DF	191 kW		01/88→02/90			
24.262 DFK	191 kW		01/88→02/90			
24.262 DFS,24.262 DFSL	191 kW		01/88→02/90			
24.262 FNL,24.262 FNLL,24.262 FVL	191 kW		01/88→02/90			
24.272 DF	198 kW		02/90→12/90			
24.272 DFK	198 kW		02/90→12/90			
24.272 DFS,24.272 DFSL	198 kW		02/90→04/95			
24.272 FNL,24.272 FNLL,24.272 FVL	198 kW		02/90→05/95			
24.272 FNLS,24.272 FVLS	198 kW		02/90→05/95			
24.292 DF	213 kW		04/87→02/90			
24.292 DFK	213 kW		04/87→02/90			
24.292 DFS,24.292 DFSL	213 kW		04/87→02/90			
24.292 FNL,24.292 FNLL,24.292 FVL	213 kW		10/86→02/90			
24.292 FNLS,24.292 FVLS	213 kW		10/86→02/90			
24.302 DF	220 kW		05/90→12/90			
24.302 DFK	220 kW		05/90→12/90			
24.302 DFS,24.302 DFSL	220 kW		05/90→04/95			
24.302 FNL,24.302 FNLL,24.302 FVL	220 kW		05/90→10/90			
24.322 DF	235 kW		02/90→12/90			
24.322 DFK	235 kW		02/90→12/90			
24.322 DFS,24.322 DFSL	235 kW		02/90→12/90			
24.322 FNL,24.322 FNLL,24.322 FVL	235 kW		02/90→05/95			
24.322 FNLS,24.322 FVLS	235 kW		02/90→05/95			
24.332 DF	243 kW		04/87→02/90			
24.332 DFK	243 kW		04/87→02/90			
24.332 DFS,24.332 DFSL	243 kW		04/87→02/90			
24.332 FNL,24.332 FNLL,24.332 FVL	243 kW		10/86→02/90			
24.332 FNLS,24.332 FVLS	243 kW		10/86→02/90			
24.342 FNL,24.342 FNLL	250 kW		05/94→05/95			
24.362 DF	265 kW		04/87→02/90			
24.362 DFK	265 kW		04/87→02/90			
24.362 DFS,24.362 DFSL	265 kW		04/87→02/90			
24.362 FNL,24.362 FNLL,24.362 FVL	265 kW		10/86→02/90			
24.362 FNLS,24.362 FVLS	265 kW		10/86→02/90			
24.372 DF	249 kW		05/90→12/90			
24.372 DFK	272 kW		02/90→12/90			
24.372 DFK	249 kW		05/90→12/90			
24.372 DFK	272 kW		02/90→12/90			
24.372 DFS	249 kW		05/90→12/90			
24.372 DFS, 24.372 DFSL	272 kW		02/90→04/95			
24.372 FNL,24.372 FNLL,24.372 FVL	272 kW		02/90→05/95			
24.372 FNLS,24.372 FVLS	272 kW		02/90→05/95			
24.372 FVL	249 kW		05/90→12/90			
24.372 FVLS	249 kW		05/90→12/90			
24.402 FNL,24.402 FNLL	294 kW		05/94→05/95			
24.422 DF	309 kW		02/90→12/90			
24.422 DFK	309 kW		02/90→12/90			
24.422 DFS,24.422 DFSL	309 kW		02/90→12/90			
24.422 FNL,24.422 FNLL,24.422 FVL	309 kW		02/90→05/95			
24.462 DF	338 kW		02/89→02/90			
24.462 DFS	338 kW		02/89→02/90			
24.462 FNL	338 kW		04/89→02/90			

Manufacturer - Model	Power	Displ.	Year of Constr.	Remark	Part Number	Page
MAN - F 90						07/86→
24.462 FVLS	338 kW		05/87→07/87	Front; L 600 mm; Quantity: 1	9XW 184 107-241 Wiper 112 Blade	
24.502 DF	368 kW		02/90→12/90			
24.502 DFK	368 kW		02/90→12/90	Front; Length [in]: 24; L 600 mm; Quantity: 1	9XW 191 397-241 Wiper 114 Blade	
24.502 DFS	368 kW		02/90→12/90			
24.502 FNL	368 kW		02/90→12/90	Front; Length 1 [mm]: 600; Quantity: 1	9XW 862 056-001 Wiper 119 Blade	
25.272 DF	198 kW		09/90→12/92			
25.272 DFK	198 kW		09/90→12/92			
25.272 DFS,25.272 DFLS	198 kW		09/90→12/92			
25.272 FNL,25.272 FNLL,25.272 FVL	198 kW		09/90→10/93			
25.302 DF	220 kW		09/90→12/91			
25.302 DFK	220 kW		09/90→12/91			
25.302 DFS, 25.302 DFLS	220 kW		09/90→12/91			
25.302 FNL, 25.302 FNLL, 25.302 FVL	220 kW		09/90→12/91			
25.302 FNLS, 25.302 FVLS	220 kW		09/90→12/91			
25.322 DF, 25.322 DFL	235 kW		09/90→12/92			
25.322 DFK	235 kW		09/90→12/92			
25.322 DFS, 25.322 DFLS	235 kW		09/90→12/92			
25.322 FNL, 25.322 FNLL, 25.322 FVL	235 kW		09/90→12/92			
25.322 FNLS,25.322 FVLS	235 kW		09/90→12/92			
25.372 DF	249 kW		09/90→12/92			
25.372 DF	272 kW		09/90→12/92			
25.372 DFK	249 kW		09/90→12/92			
25.372 DFK	272 kW		09/90→12/92			
25.372 DFS	249 kW		09/90→12/92			
25.372 DFS,25.372 DFLS	272 kW		09/90→12/92			
25.372 FNL, 25.372 FNLL, 25.372 FVL	272 kW		09/90→12/92			
25.372 FNLS,25.372 FVLS	272 kW		09/90→10/93			
25.372 FVLS	249 kW		09/90→10/93			
25.422 DF	309 kW		09/90→12/92			
25.422 DFK	309 kW		09/90→12/92			
25.422 DFS,25.422 DFLS	309 kW		09/90→12/92			
25.422 FNL,25.422 FNLL	309 kW		09/90→12/92			
25.422 FNLS,25.422 FVLS	309 kW		09/90→12/92			
25.502 DF	368 kW		09/90→12/92			
25.502 DFS	368 kW		09/90→12/92			
25.502 FNL	368 kW		09/90→12/92			
26.242 DF	177 kW		01/88→07/89			
26.242 DFAK	177 kW		02/89→07/89			
26.242 DFK	177 kW		01/88→07/89			
26.242 DFS	177 kW		01/88→07/89			
26.262 DF	191 kW		01/88→02/90			
26.262 DFA	191 kW		02/89→02/90			
26.262 DFAK	191 kW		02/89→02/90			
26.262 DFAS	191 kW		02/89→02/90			
26.262 DFK	191 kW		01/88→02/90			
26.262 DFS	191 kW		01/88→02/90			
26.272 DF	198 kW		02/90→06/96			
26.272 DFA	198 kW		02/90→12/92			
26.272 DFAK	198 kW		02/90→12/92			
26.272 DFAS	198 kW		02/90→12/92			
26.272 DFK	198 kW		02/90→06/96			
26.272 DFS,26.272 DFLS	198 kW		02/90→06/96			
26.272 FNL,26.272 FNLL	198 kW		03/91→05/95			
26.272 FNLS,26.272 FVLS	198 kW		09/90→12/95			
26.292 DF, 26.292 DFL	213 kW		09/87→02/90			
26.292 DFA	213 kW		05/88→02/90			
26.292 DFAK	213 kW		05/88→02/90			
26.292 DFAS	213 kW		05/88→02/90			
26.292 DFK	213 kW		09/87→02/90			
26.292 DFS	213 kW		09/87→02/90			
26.302 DF	220 kW		05/90→12/91			
26.302 DFA	220 kW		05/90→12/91			
26.302 DFAK	220 kW		05/90→12/91			
26.302 DFAS	220 kW		05/90→12/91			
26.302 DFK	220 kW		05/90→12/91			
26.302 DFS	220 kW		05/90→12/91			
26.302 FNL, 26.302 FNLL, 26.302 FVL	220 kW		03/91→12/91			
26.302 FNLS,26.302 FVLS	220 kW		09/90→12/91			
26.322 DF	235 kW		02/90→06/96			
26.322 DFA	235 kW		02/90→12/92			
26.322 DFAK	235 kW		02/90→12/92			
26.322 DFAS	235 kW		02/90→12/92			
26.322 DFK	235 kW		02/92→06/96			
26.322 DFS,26.322 DFLS	235 kW		02/90→06/96			
26.322 FNL,26.322 FNLL	235 kW		03/91→05/95			
26.322 FNLS,26.322 FVLS	235 kW		09/90→12/95			

Manufacturer - Model	Power	Displ.	Year of Constr.	Remark	Part Number	Page
MAN - F 90						07/86→
26.332 DF, 26.332 DFL	243 kW		09/87→02/90	Front; L 600 mm; Quantity: 1	9XW 184 107-241 Wiper 112 Blade	
26.332 DFA	243 kW		05/88→02/90			
26.332 DFAK	243 kW		05/88→02/90	Front; Length [in]: 24; L 600 mm; Quantity: 1	9XW 191 397-241 Wiper 114 Blade	
26.332 DFAS	243 kW		05/88→02/90			
26.332 DFK	243 kW		09/87→02/90			
26.332 DFS	243 kW		09/87→02/90	Front; Length 1 [mm]: 600; Quantity: 1	9XW 862 056-001 Wiper 119 Blade	
26.342 DF, 26.342 DFL	250 kW		05/94→06/96			
26.342 DFK, 26.342 DFLK	250 kW		05/94→06/96			
26.342 DFS	250 kW		04/94→06/96			
26.362 DF, 26.362 DFL	265 kW		09/87→02/90			
26.362 DFA	265 kW		05/88→02/90			
26.362 DFAK	265 kW		05/88→02/90			
26.362 DFAS	265 kW		05/88→02/90			
26.362 DFK	265 kW		09/87→02/90			
26.362 DFS	265 kW		09/87→02/90			
26.372 DF, 26.372 DFL	272 kW		02/90→06/96			
26.372 DFA	272 kW		02/90→12/92			
26.372 DFAK	272 kW		01/92→06/96			
26.372 DFAS	272 kW		02/90→12/92			
26.372 DFK	272 kW		01/92→06/96			
26.372 DFS	272 kW		02/90→06/96			
26.372 FNL, 26.372 FNLL, 26.372 FVL	272 kW		09/90→12/95			
26.372 FNLS, 26.372 FVLS	272 kW		01/92→06/96			
26.402 DF, 26.402 DFL	294 kW		05/94→06/96			
26.402 DFK, 26.402 DFLK	294 kW		05/94→06/96			
26.402 DFS	294 kW		05/94→12/95			
26.402 FNL, 26.402 FNLL, 26.402 FVL	294 kW		05/94→06/96			
26.402 FNLS, 26.402 FVLS	294 kW		05/94→06/96			
26.422 DF, 26.422 DFL	309 kW		02/90→06/96			
26.422 DFA	309 kW		02/90→12/92			
26.422 DFAK	309 kW		02/90→12/92			
26.422 DFAS	309 kW		02/90→12/92			
26.422 DFK	309 kW		02/90→12/95			
26.422 DFS	309 kW		02/90→12/95			
26.422 FNL, 26.422 FNLL, 26.422 FVL	309 kW		09/90→12/95			
26.422 FNLS, 26.422 FVLS	309 kW		01/92→12/95			
26.462 DF	338 kW		02/89→02/90			
26.462 DFA	338 kW		08/89→02/90			
26.462 DFAS	338 kW		08/89→02/90			
26.462 DFS	338 kW		02/89→02/90			
26.502 DF	368 kW		02/90→06/96			
26.502 DFA	368 kW		02/90→12/92			
26.502 DFAS	368 kW		02/90→12/92			
26.502 DFS, 26.502 DFLS	368 kW		02/90→06/96			
26.502 FNL, 26.502 FNLL	368 kW		09/91→06/96			
32.262 VF	191 kW		02/89→02/90			
32.262 VFK	191 kW		02/89→02/90			
32.262 VFTM	191 kW		02/89→02/90			
32.272 VF	198 kW		02/90→04/95			
32.272 VFK	198 kW		02/90→04/95			
32.292 VF	213 kW		03/88→02/90			
32.292 VFK	213 kW		03/88→02/90			
32.302 VF	220 kW		05/90→09/91			
32.302 VFK	220 kW		05/90→09/91			
32.322 VF	235 kW		02/90→06/96			
32.322 VFK	235 kW		02/90→06/96			
32.332 VF	243 kW		03/88→02/90			
32.332 VFK	243 kW		03/88→02/90			
32.342 VFK	250 kW		05/94→06/96			
32.362 VF	265 kW		03/88→02/90			
32.362 VFK	265 kW		03/88→02/90			
32.372 VF	249 kW		02/90→06/96			
32.372 VFK	272 kW		02/90→06/96			
32.372 VFK	249 kW		05/90→04/95			
32.372 VFK	272 kW		02/90→06/96			
32.402 VFK	294 kW		05/94→06/96			
32.422 VF	309 kW		02/90→06/96			
32.422 VFK	309 kW		02/90→06/96			
33.242 DFAK	177 kW		01/88→08/88			
33.242 DFK	177 kW		01/88→08/88			
33.262 DF	191 kW		08/88→02/90			
33.262 DFA	191 kW		07/89→02/90			
33.262 DFAK	191 kW		07/89→02/90			
33.262 DFK	191 kW		08/88→02/90			
33.272 DF	198 kW		10/92→04/95			
33.272 DFA	198 kW		10/92→04/95			
33.272 FVL	191 - 198 kW		10/92→04/95			
33.292 DF	213 kW		09/87→02/90			

Manufacturer - Model	Power	Displ.	Year of Constr.	Remark	Part Number	Page
MAN - F 90						07/86→
33.292 DFA	213 kW		05/88→02/90	Front; L 600 mm; Quantity: 1	9XW 184 107-241 Wiper 112 Blade	
33.292 DFAK	213 kW		05/88→02/90			
33.292 DFAS	213 kW		05/88→02/90	Front; Length [in]: 24; L 600 mm; Quantity: 1	9XW 191 397-241 Wiper 114 Blade	
33.292 DFK	213 kW		09/87→02/90			
33.292 DFS	213 kW		09/87→02/90	Front; Length 1 [mm]: 600; Quantity: 1	9XW 862 056-001 Wiper 119 Blade	
33.322 DF	235 kW		09/91→06/96			
33.322 DFA	235 kW		09/91→06/96			
33.322 FVL	235 kW		09/91→06/96			
33.332 DF	243 kW		09/87→02/90			
33.332 DFA	243 kW		05/88→02/90			
33.332 DFAK	243 kW		05/88→02/90			
33.332 DFAS	243 kW		05/88→02/90			
33.332 DFK	243 kW		09/87→02/90			
33.332 DFS	243 kW		09/87→02/90			
33.342 DF	250 kW		05/94→06/96			
33.342 DFA	250 kW		05/94→06/96			
33.362 DF	265 kW		09/87→02/90			
33.362 DFA	265 kW		05/88→02/90			
33.362 DFAK	265 kW		05/88→02/90			
33.362 DFAS	265 kW		05/88→02/90			
33.362 DFK	265 kW		09/87→02/90			
33.362 DFS	265 kW		09/87→02/90			
33.372 DF	272 kW		09/91→06/96			
33.372 DFA	272 kW		09/91→06/96			
33.372 DFAK	272 kW		01/91→06/96			
33.372 DFK	272 kW		01/91→06/96			
33.372 DFS	272 kW		09/91→06/96			
33.402 DF	294 kW		05/94→06/96			
33.402 DFA	294 kW		05/94→06/96			
33.402 DFAK	294 kW		05/94→06/96			
33.402 DFK	294 kW		05/94→06/96			
33.402 DFS	294 kW		05/94→06/96			
33.422 DF	309 kW		09/91→06/96			
33.422 DFA	309 kW		09/91→06/96			
33.422 DFAK	309 kW		01/94→06/96			
33.422 DFK	309 kW		01/94→06/96			
33.422 DFS	309 kW		01/94→06/96			
33.462 DF	338 kW		07/89→02/90			
33.462 DFA	338 kW		07/89→02/90			
33.502 DF	368 kW		09/91→06/96			
33.502 DFA	368 kW		09/91→06/96			
35.262 VF	191 kW		02/89→02/90			
35.262 VFA	191 kW		07/89→02/90			
35.262 VFK	191 kW		02/89→02/90			
35.272 VF	198 kW		02/90→12/91			
35.272 VFK	198 kW		02/90→12/92			
35.292 VF	213 kW		10/88→04/95			
35.292 VFK	213 kW		10/88→04/95			
35.302 VF	220 kW		05/90→09/91			
35.302 VFA	220 kW		05/90→09/91			
35.302 VFAK	220 kW		05/90→09/91			
35.302 VFK	220 kW		05/90→09/91			
35.322 VFAK	235 kW		02/90→06/96			
35.322 VFK	235 kW		02/90→06/96			
35.322 VK	235 kW		02/90→06/96			
35.332 VFK	243 kW		10/88→04/95			
35.342 VF	250 kW		05/94→06/96			
35.342 VFK	250 kW		05/94→06/96			
35.362 VF	265 kW		10/88→02/90			
35.362 VFK	265 kW		10/88→02/90			
35.372 VF	249 kW		02/90→04/95			
35.372 VFK	272 kW		02/90→06/96			
35.372 VF	272 kW		02/90→12/97			
35.372 VFK	249 kW		02/90→04/95			
35.372 VFK	272 kW		02/90→06/96			
35.372 VFK	272 kW		02/90→12/97			
35.402 VF	294 kW		05/94→06/96			
35.402 VF	294 kW		05/94→12/97			
35.402 VFK	294 kW		05/94→06/96			
35.402 VFK	294 kW		05/94→12/97			
35.422 VF	309 kW		02/90→06/96			
35.422 VF	309 kW		02/90→12/97			
35.422 VFK	309 kW		02/90→06/96			
35.422 VFK	309 kW		02/90→12/97			
40.372 DF	272 kW		12/91→06/96			
40.372 DFA	272 kW		12/91→06/96			
40.402 DF	294 kW		05/95→06/96			
40.402 DFA	294 kW		05/95→06/96			
40.422 DF	309 kW		12/91→06/96			
40.422 DFA	309 kW		12/91→06/96			
40.462 DF	338 kW		07/89→02/90			

Manufacturer - Model	Power	Displ.	Year of Constr.	Remark	Part Number	Page
MAN - F 90						07/86→
40.462 DFA	338 kW		07/89→02/90	Front; L 600 mm; Quantity: 1	9XW 184 107-241 Wiper 112 Blade	
40.502 DFA	368 kW		02/90→06/96			
41.262 VF	191 kW		07/89→02/90	Front; Length [in]: 24; L 600 mm; Quantity: 1	9XW 191 397-241 Wiper 114 Blade	
41.262 VFK	191 kW		07/89→02/90			
41.272 VF	198 kW		02/90→12/91			
41.292 VF	213 kW		10/88→02/90	Front; Length 1 [mm]: 600; Quantity: 1	9XW 862 056-001 Wiper 119 Blade	
41.292 VFK	213 kW		10/88→02/90			
41.322 VF	235 kW		02/90→06/96			
41.332 VF	243 kW		10/88→02/90			
41.332 VFK	243 kW		10/88→02/90			
41.342 VF	250 kW		05/94→06/96			
41.362 VF	265 kW		10/88→02/90			
41.362 VFK	265 kW		10/88→02/90			
41.372 VF	272 kW		02/90→06/96			
41.402 VF	294 kW		05/94→06/96			
41.422 VF	309 kW		02/90→06/96			
48.292 VF	213 kW		07/89→02/90			
48.292 VFA	213 kW		07/89→02/90			
48.292 VFAK	213 kW		07/89→02/90			
48.332 VF	243 kW		07/89→02/90			
48.332 VFA	243 kW		07/89→02/90			
48.332 VFAK	243 kW		07/89→02/90			
48.362 VF	265 kW		07/89→02/90			
48.362 VFA	265 kW		07/89→02/90			
48.362 VFAK	265 kW		07/89→02/90			
48.462 VF	338 kW		07/89→02/90			
35.332 VF	243 kW		10/88→04/95	elec.; Mono Pump; 24 V; with sensor for wash-water level	8TW 006 849-091 Water 111 Pump, window cleaning	
				Front; L 600 mm; Quantity: 1	9XW 184 107-241 Wiper 112 Blade	
				Front; Length [in]: 24; L 600 mm; Quantity: 1	9XW 191 397-241 Wiper 114 Blade	
				Front; Length 1 [mm]: 600; Quantity: 1	9XW 862 056-001 Wiper 119 Blade	
MAN - F 2000						01/94→
18.273 F, FL, FLL	198 kW		06/94→	Front; L 600 mm; Quantity: 1	9XW 184 107-241 Wiper 112 Blade	
19.233 FKNG	170 kW					
19.314 FAC	228 kW		05/01→	Front; Length [in]: 24; L 600 mm; Quantity: 1	9XW 191 397-241 Wiper 114 Blade	
19.314 FAK, FA-KI	228 kW		05/01→			
19.464 FAC	338 kW		06/98→	Front; Length 1 [mm]: 600; Quantity: 1	9XW 862 056-001 Wiper 119 Blade	
23.314 FNLLC	228 kW		05/01→			
23.364 FNLLC	265 kW		05/01→			
23.414 FNLLC	301 kW		05/01→			
23.464 FNLLC	338 kW		05/01→			
24.314 FNLLRC	228 kW		05/01→			
24.364 FNLLRC	265 kW		05/01→			
24.414 FNLLRC	301 kW		05/01→			
24.464 FNLLRC	338 kW		05/01→			
26.233 FVL-KO	170 kW		03/00→			
26.314 DFC, DFLC	228 kW		05/01→			
26.314 DFK, DFLK	228 kW		05/01→			
26.314 DFS, DFSL	228 kW		05/01→			
26.314 DF-TM	228 kW		05/01→			
26.314 FNLC, FNLLC, FNLLRC, FNLLW, FVLC	228 kW		05/01→			
26.314 FNLS	228 kW		05/01→			
26.314 FVL-KO	228 kW		05/01→			
26.314 FVLS, FVLRS	228 kW		05/01→			
26.364 DFC, DFLC	265 kW		05/01→			
26.364 DFK, DFLK	265 kW		05/01→			
26.364 DFS, DFSL	265 kW		05/01→			
26.364 DF-TM	265 kW		05/01→			
26.364 FNLC, FNLLC, FNLLRC, FNLLW, FVLC	265 kW		05/01→			
26.364 FNLS	265 kW		05/01→			
26.364 FVL-KO	265 kW		05/01→			
26.364 FVLS, FVLRS	265 kW		05/01→			
26.414 DFC, DFLC	301 kW		05/01→			
26.414 DFK, DFLK	301 kW		05/01→			
26.414 DFS, DFSL	301 kW		05/01→			
26.414 DF-TM	301 kW		05/01→			
26.414 FNLC, FNLLC, FNLLRC, FNLLW, FVLC	301 kW		05/01→			
26.414 FNLS	301 kW		05/01→			
26.414 FVL-KO	301 kW		05/01→			
26.414 FVLS, FVLRS	301 kW		05/01→			
26.464 DFC, DFLC	338 kW		05/01→			
26.464 DFK, DFLK	338 kW		05/01→			
26.464 DFS, DFSL	338 kW		05/01→			

Manufacturer - Model	Power	Displ.	Year of Constr.	Remark	Part Number	Page
MAN - F 2000						01/94→
26.464 DF-TM	338 kW		05/01→	Front; L 600 mm; Quantity: 1	9XW 184 107-241 Wiper 112 Blade	
26.464 FNLC, FNLLC, FNLLW, FVLC	338 kW		05/01→			
26.464 FNLS	338 kW		05/01→	Front; Length [in]: 24; L 600 mm; Quantity: 1	9XW 191 397-241 Wiper 114 Blade	
26.464 FVL-KO	338 kW		05/01→			
26.464 FVLS, FVLRS	338 kW		05/01→	Front; Length 1 [mm]: 600; Quantity: 1	9XW 862 056-001 Wiper 119 Blade	
26.604 DFSL	441 kW		04/00→			
27.314 DFAC	228 kW		05/01→			
27.314 DFAK, DFA-KI	228 kW		05/01→			
27.314 DFAS	228 kW		05/01→			
27.314 DFC	228 kW		05/01→			
27.314 DFK, DF-KI	228 kW		05/01→			
27.314 DFS	228 kW		05/01→			
27.314 DF-TM	228 kW		05/01→			
27.364 DFAC	265 kW		05/01→			
27.364 DFAK, DFA-KI	265 kW		05/01→			
27.364 DFAS	265 kW		05/01→			
27.364 DFC	265 kW		05/01→			
27.364 DFK, DF-KI	265 kW		05/01→			
27.364 DFS	265 kW		05/01→			
27.364 DF-TM	265 kW		05/01→			
27.373 DF-TM	272 kW		07/00→			
27.403 DF-TM	294 kW		07/00→			
27.414 DFAC	301 kW		05/01→			
27.414 DFAK, DFA-KI	301 kW		05/01→			
27.414 DFAS	301 kW		05/01→			
27.414 DFC	301 kW		05/01→			
27.414 DFK, DF-KI	301 kW		05/01→			
27.414 DFS	301 kW		05/01→			
27.414 DF-TM	301 kW		05/01→			
27.423 DF-TM	309 kW		07/00→			
27.463 DF-TM	338 kW		07/00→			
27.464 DFAC	338 kW		05/01→			
27.464 DFAK, DFA-KI	338 kW		05/01→			
27.464 DFAS	338 kW		05/01→			
27.464 DFC	338 kW		01/94→			
27.464 DFK, DF-KI	338 kW		05/01→			
27.464 DFS	338 kW		01/94→			
27.464 DF-TM	338 kW		05/01→			
32.314 VF, VFC	228 kW		05/01→			
32.314 VFK, VF-HK	228 kW		05/01→			
32.314 VF-TM	228 kW		05/01→			
32.364 VF, VFC	265 kW		05/01→			
32.364 VFK, VF-HK	265 kW		05/01→			
32.364 VF-TM	265 kW		05/01→			
32.414 VF, VFC	301 kW		05/01→			
32.414 VFK, VF-HK	301 kW		05/01→			
32.414 VF-TM	301 kW		05/01→			
32.464 VF, VFC	338 kW		05/01→			
32.464 VFK, VF-HK	338 kW		05/01→			
32.464 VF-TM	338 kW		05/01→			
33.364 DFAC	265 kW		05/01→			
33.364 DFAK, DFA-KI	265 kW		05/01→			
33.364 DFAS	265 kW		05/01→			
33.364 DFC	265 kW		05/01→			
33.364 DFK, DF-KI	265 kW		05/01→			
33.364 DFS, DFRS	265 kW		05/01→			
33.414 DFAC	301 kW		05/01→			
33.414 DFAK, DFA-KI	301 kW		05/01→			
33.414 DFAS	301 kW		05/01→			
33.414 DFC	301 kW		05/01→			
33.414 DFK, DF-KI	301 kW		05/01→			
33.414 DFS, DFRS	301 kW		05/01→			
33.464 DFAC	338 kW		05/01→			
33.464 DFAK, DFA-KI	338 kW		05/01→			
33.464 DFAS	338 kW		05/01→			
33.464 DFC	338 kW		05/01→			
33.464 DFK, DF-KI	338 kW		05/01→			
33.464 DFS, DFRS	338 kW		05/01→			
35.314 VF-TM	228 kW		03/02→			
35.364 VF, VFC, VFRC	265 kW		05/01→			
35.364 VFK, VF-HK, VF-KI	265 kW		03/02→			
35.364 VF-TM	265 kW		03/02→			
35.373 VF, VFC, VFRC	272 kW		05/01→			
35.373 VFK, VF-HK, VF-KI	272 kW		03/02→			
35.414 VF, VFC, VFRC	301 kW		05/01→			
35.414 VFK, VF-HK, VF-KI	301 kW		03/02→			
35.414 VF-TM	301 kW		03/02→			
35.423 VF, VFC	309 kW		05/01→			
35.423 VFK, VF-HK, VF-KI	309 kW		03/02→			
35.464 VF, VFC, VFRC	338 kW		05/01→			

Manufacturer - Model	Power	Displ.	Year of Constr.	Remark	Part Number	Page
MAN - F 2000						01/94→
35.464 VFK, VF-HK, VF-KI	338 kW		03/02→	Front; L 600 mm; Quantity: 1	9XW 184 107-241 Wiper Blade	112
35.464 VF-TM	338 kW		03/02→			
40.373 DFAK	272 kW		05/01→	Front; Length [in]: 24; L 600 mm; Quantity: 1	9XW 191 397-241 Wiper Blade	114
40.373 DFK	272 kW		05/01→			
40.414 DFAK	301 kW		05/01→			
40.414 DFK	301 kW		05/01→	Front; Length 1 [mm]: 600; Quantity: 1	9XW 862 056-001 Wiper Blade	119
40.423 DFAK	309 kW		05/01→			
40.423 DFK	309 kW		05/01→			
41.364 VF, VFC, VFRC	265 kW		05/01→			
41.364 VFK, VF-HK, VF-KI	265 kW		03/02→			
41.373 VF, VFC, VFRC	272 kW		05/01→			
41.373 VFK, VF-HK, VF-KI	272 kW		03/02→			
41.414 VF, VFC, VFRC	301 kW		05/01→			
41.414 VFK, VF-HK, VF-KI	301 kW		03/02→			
41.423 VF, VFC, VFRC	309 kW		05/01→			
41.423 VFK, VF-HK, VF-KI	309 kW		03/02→			
41.464 VF, VFC, VFRC	338 kW		06/98→			
41.464 VFK, VF-HK, VF-KI	338 kW		03/02→			
19.233 FCNG	170 kW			Delivery Quantity [l/h]: 432; elec.; Blade Terminal; Pressure [bar]: 2.5; Pressure hose connector diameter [mm]: 11; Mono Pump; 24 V; Suction pipe connector diameter [mm]: 10.5	8TW 004 764-041 Water Pump, headlight cleaning	110
19.273 F, FL, FLL	198 kW		01/94→			
19.273 FA	198 kW		01/94→			
19.273 FAK	198 kW		01/94→			
19.273 FK	198 kW		01/94→			
19.273 FS, 19.273 FLS	198 kW		01/94→12/95			
19.293 FAC	213 kW		01/94→			
19.293 FAK	213 kW		01/94→			
19.293 FAS	213 kW		01/94→			
19.293 FC, 19.293 FLC, 19.293 FLLC	213 kW		01/94→			
19.293 FK, 19.293 FLK	213 kW		01/94→	Front; L 600 mm; Quantity: 1	9XW 184 107-241 Wiper Blade	112
19.293 FS, 19.293 FLS, 19.293 FLLS	213 kW		01/94→			
19.314 FAS	228 kW		06/98→	Front; Length [in]: 24; L 600 mm; Quantity: 1	9XW 191 397-241 Wiper Blade	114
19.314 FC, FLC, FLLC, FLLW, FRC, FLRC, FLLRC, FLL, FLLR, F-N	228 kW		06/98→			
19.314 FK, FLK, F-KI, FL-KI	228 kW		06/98→			
19.314 FS, FLS, FLLS, FRS, FLRS, FLLRS	228 kW		06/98→			
19.323 FAC	235 kW		01/94→12/95			
19.323 FAK	235 kW		01/94→12/95			
19.323 FAS	235 kW		01/94→12/95			
19.323 FC, 19.323 FLC, 19.323 FLLC	235 kW		01/94→12/95			
19.323 FK, 19.323 FLK	235 kW		01/94→12/95			
19.323 FS, 19.323 FLS, 19.323 FLLS	235 kW		01/94→12/95			
19.343 FAC	250 kW		01/94→			
19.343 FAK	250 kW		01/94→			
19.343 FAS	250 kW		01/94→			
19.343 FC, 19.343 FLC, 19.343 FLLC	250 kW		01/94→			
19.343 FK, 19.343 FLK	250 kW		01/94→			
19.343 FS, 19.343 FLS, 19.343 FLLS	250 kW		01/94→			
19.364 FAC	265 kW		06/98→			
19.364 FAK, FA-KI	265 kW		06/98→			
19.364 FAS	265 kW		06/98→			
19.364 FC, FLC, FLLC, FLLW, FRC, FLRC, FLLRC, FLL, FLLR, F-N	265 kW		06/98→			
19.364 FK, FLK, F-KI, FL-KI	265 kW		06/98→			
19.364 FS, FLS, FLLS, FRS, FLRS, FLLRS	265 kW		06/98→			
19.373 FAC	272 kW		01/94→			
19.373 FAK, FA-KI	272 kW		01/94→			
19.373 FAS	272 kW		01/94→			
19.373 FC, FLC, FLLC, FRC, FLRC, F-NL	272 kW		01/94→			
19.373 FK, FLK, F-KI, FL-KI	272 kW		01/94→			
19.373 FS, FLS, FLLS, FRS, FLRS, FLLRS	272 kW		01/94→			
19.403 FAC	294 kW		01/94→			
19.403 FAK, FA-KI	294 kW		01/94→			
19.403 FAS	294 kW		01/94→			
19.403 FC, FLC, FLLC, FRC, FLRC, F-NL	294 kW		01/94→			
19.403 FK, FLK, F-KI, FL-KI	294 kW		01/94→			
19.403 FS, FLS, FLLS, FRS, FLRS, FLLRS	294 kW		01/94→			
19.414 FAC	301 kW		06/98→			

Manufacturer - Model	Power	Displ.	Year of Constr.	Remark	Part Number	Page
MAN - F 2000						01/94→
19.414 FAK, FA-KI	301 kW		06/98→	Delivery Quantity [l/h]: 432; elec.; Blade Terminal; Pressure [bar]: 2.5; Pressure hose connector diameter [mm]: 11; Mono Pump; 24 V; Suction pipe connector diameter [mm]: 10.5	8TW 004 764-041 Water Pump, headlight cleaning	110
19.414 FAS	301 kW		06/98→			
19.414 FC, FLC, FLLC, FRC, FLRC, FLLRC, FLL, FLLR, F-NL	301 kW		06/98→			
19.414 FK, FLK, F-KI, FL-KI	301 kW		06/98→	use plug 81.25435-0134; cap 81.26412-0013; cap 81.96410-0342 as well, according to plug connection (MAN) ; Yugoslavia: Delivery Quantity [l/h]: 432; Housing Diameter [mm]: 35; elec.; Pressure [bar]: 2.5; Pressure hose connector diameter [mm]: 11; Mono Pump; Quantity: 32; 24 V; Suction pipe connector diameter [mm]: 10.5	8TW 007 540-037 Water Pump, headlight cleaning	110
19.414 FS, FLS, FLLS, FRS, FLRS, FLLRS	301 kW		06/98→			
19.423 FAC	309 kW		01/94→12/95			
19.423 FAK, FA-KI	309 kW		01/94→	Front; L 600 mm; Quantity: 1	9XW 184 107-241 Wiper Blade	112
19.423 FAS	309 kW		01/94→12/95			
19.423 FC, FLC, FLLC, F-NL	309 kW		01/94→			
19.423 FK, FLK, F-KI, FL-KI	309 kW		01/94→	Front; Length [in]: 24; L 600 mm; Quantity: 1	9XW 191 397-241 Wiper Blade	114
19.423 FS, FLS, FLLS	309 kW		01/94→			
19.463 FAC	338 kW		01/94→			
19.463 FAK, FA-KI	338 kW		01/94→	Front; Length 1 [mm]: 600; Quantity: 1	9XW 862 056-001 Wiper Blade	119
19.463 FAS	338 kW		01/94→			
19.463 FC, FLC, FLLC, FRC, FLRC, F-NL	338 kW		01/94→			
19.463 FK, FLK, F-KI, FL-KI	338 kW		01/94→			
19.463 FS, FLS, FLLS, FRS, FLRS, FLLRS	338 kW		01/94→			
19.464 FAK, FA-KI	338 kW		06/98→			
19.464 FAS	338 kW		06/98→			
19.464 FC, FLC, FLLC, FLL, FRC, FLLR, FLLRC, FLLW, F-NL	338 kW		06/98→			
19.464 FK, FLK, F-KI, FL-KI	338 kW		06/98→			
19.464 FS, FLS, FLLS, FRS, FLRS, FLLRS	338 kW		06/98→			
19.603 FLS, 19604 FLS	441 kW		04/96→			
23.293 FNLLC	213 kW		01/94→			
23.343 FNLLC	250 kW		01/94→			
23.403 FNLLC	294 kW		01/94→			
23.463 FNLLC	338 kW		01/94→			
24.273 FNLLC	198 kW		01/94→12/95			
24.293 FNLLC	213 kW		01/94→			
24.323 FNLLC	235 kW		01/94→12/95			
24.343 FNLLC	250 kW		01/94→			
24.373 FNLLC	272 kW		01/94→12/95			
24.403 FNLLC	294 kW		01/94→			
24.423 FNLLC	309 kW		01/94→12/95			
24.463 FNLLC	338 kW		01/94→			
26.233 FVL CNG	170 kW		09/96→			
26.273 DFC,26.273 DFCL	198 kW		01/94→12/95			
26.273 DFK,26.273 DFLK	198 kW		01/94→12/95			
26.273 DFS,26.273 DFSL	198 kW		01/94→12/95			
26.273 FNLC,26.273 FNLLC, 26.273 FVLC	198 kW		01/94→12/95			
26.273 FNLS,26.273 FVLS	198 kW		01/94→12/95			
26.293 DFC,26.293 DFCL	213 kW		01/94→			
26.293 DFK,26.293 DFLK	213 kW		01/94→			
26.293 DFS,26.293 DFSL	213 kW		01/94→			
26.293 FNLC,26.293 FNLLC, 26.293 FVLC	213 kW		01/94→			
26.293 FNLS,26.293 FVLS	213 kW		01/94→			
26.323 DFC,26.323 DFCL	235 kW		01/94→12/95			
26.323 DFK,26.323 DFLK	235 kW		01/94→12/95			
26.323 DFS,26.323 DFSL	235 kW		01/94→12/95			
26.323 FNLC,26.323 FNLLC, 26.323 FVLC	235 kW		01/94→12/95			
26.323 FNLS,26.323 FVLS	235 kW		01/94→12/95			
26.343 DFC,26.343 DFCL	250 kW		01/94→			
26.343 DFK,26.343 DFLK	250 kW		01/94→			
26.343 DFS,26.343 DFSL	250 kW		01/94→			
26.343 FNLC,26.343 FNLLC, 26.343 FVLC	250 kW		01/94→			
26.343 FNLS,26.343 FVLS	250 kW		01/94→			
26.373 DFC,26.373 DFCL	272 kW		01/94→12/95			
26.373 DFK,26.373 DFLK	272 kW		01/94→12/95			
26.373 DFS,26.373 DFSL	272 kW		01/94→12/95			
26.373 FNLC,26.373 FNLLC, 26.373 FVLC	272 kW		01/94→12/95			
26.373 FNLS,26.373 FVLS	272 kW		01/94→12/95			
26.403 DFC,26.403 DFCL	294 kW		01/94→			
26.403 DFK,26.403 DFLK	294 kW		01/94→			
26.403 DFS,26.403 DFSL	294 kW		01/94→			
26.403 FNLC,26.403 FNLLC, 26.403 FVLC	294 kW		01/94→			
26.403 FNLS,26.403 FVLS	294 kW		01/94→			
26.423 DFC,26.423 DFCL	309 kW		01/94→12/95			
26.423 DFK,26.423 DFLK	309 kW		01/94→12/95			
26.423 DFS,26.423 DFSL	309 kW		01/94→12/95			

Manufacturer - Model	Power	Displ.	Year of Constr.	Remark	Part Number	Page
MAN - F 2000						01/94→
26.423 FNLC,26.423 FNLLC, 26.423 FVLC	309 kW		01/94→12/95	Delivery Quantity [l/h]: 432; elec.; Blade Terminal; Pressure [bar]: 2.5; Pressure hose connector diameter [mm]: 11; Mono Pump; 24 V; Suction pipe connector diameter [mm]: 10.5	8TW 004 764-041 Water Pump, headlight cleaning	110
26.423 FNLS,26.423 FVLS	309 kW		01/94→12/95			
26.463 DFC, DFCL	338 kW		01/94→			
26.463 DFK,26.463 DFLK	338 kW		01/94→	use plug 81.25435-0134; cap 81.26412-0013; cap 81.96410-0342 as well, according to plug connection (MAN) ; Yugoslavia: Delivery Quantity [l/h]: 432; Housing Diameter [mm]: 35; elec.; Pressure [bar]: 2.5; Pressure hose connector diameter [mm]: 11; Mono Pump; Quantity: 32; 24 V; Suction pipe connector diameter [mm]: 10.5	8TW 007 540-037 Water Pump, headlight cleaning	110
26.463 DFS,26.463 DFSL	338 kW		01/94→			
26.463 FNLC, FNLLC, FVLC	338 kW		01/94→			
26.463 FNLS,26.463 FVLS	338 kW		01/94→			
26.603 DFC, DFCL	441 kW		06/96→			
26.603 DFK, DFLK	441 kW		06/96→			
26.603 DFS, DFSL	441 kW		06/96→			
27.273 DFAC	198 kW		01/94→12/95	Front; L 600 mm; Quantity: 1	9XW 184 107-241 Wiper Blade	112
27.273 DFAK	198 kW		01/94→12/95			
27.273 DFAS	198 kW		01/94→12/95	Front; Length [in]: 24; L 600 mm; Quantity: 1	9XW 191 397-241 Wiper Blade	114
27.273 DFC	198 kW		01/94→12/95			
27.273 DFK	198 kW		01/94→12/95			
27.273 DFS	198 kW		01/94→12/95	Front; Length 1 [mm]: 600; Quantity: 1	9XW 862 056-001 Wiper Blade	119
27.293 DFAC	213 kW		01/94→			
27.293 DFAK	213 kW		01/94→			
27.293 DFAS	213 kW		01/94→			
27.293 DFC	213 kW		01/94→			
27.293 DFK	213 kW		01/94→			
27.293 DFS	213 kW		01/94→			
27.314 FVL	228 kW		06/98→			
27.323 DFAC	235 kW		01/94→12/95			
27.323 DFAK, DFA-KI	235 kW		01/94→			
27.323 DFAS	235 kW		01/94→12/95			
27.323 DFC	235 kW		01/94→12/95			
27.323 DFK, DF-KI	235 kW		01/94→			
27.323 DFS	235 kW		01/94→12/95			
27.343 DFAC	250 kW		01/94→			
27.343 DFAK	250 kW		01/94→			
27.343 DFAS	250 kW		01/94→			
27.343 DFC	250 kW		01/94→			
27.343 DFK	250 kW		01/94→			
27.343 DFS	250 kW		01/94→			
27.364 FVL	265 kW		06/98→			
27.373 DFAC	272 kW		01/94→			
27.373 DFAK, DFA-KI	272 kW		01/94→			
27.373 DFAS	272 kW		01/94→			
27.373 DFC	272 kW		01/94→			
27.373 DFK, DF-KI	272 kW		01/94→			
27.373 DFS	272 kW		01/94→			
27.403 DFAC	294 kW		01/94→			
27.403 DFAK, DFA-KI	294 kW		01/94→			
27.403 DFAS	294 kW		01/94→			
27.403 DFC	294 kW		01/94→			
27.403 DFK, DF-KI	294 kW		01/94→			
27.403 DFS	294 kW		01/94→			
27.414 FVL	301 kW		06/98→			
27.423 DFAC	309 kW		01/94→			
27.423 DFAK, DFA-KI	309 kW		01/94→			
27.423 DFAS	309 kW		01/94→12/95			
27.423 DFC	309 kW		01/94→			
27.423 DFK, DF-KI	309 kW		01/94→			
27.423 DFS	309 kW		01/94→			
27.463 DFAC	338 kW		01/94→			
27.463 DFAK, DFA-KI	338 kW		01/94→			
27.463 DFAS	338 kW		01/94→			
27.463 DFC	338 kW		01/94→			
27.463 DFK, DF-KI	338 kW		01/94→			
27.463 DFS	338 kW		01/94→			
27.464 FVL	338 kW		06/98→			
27.603 DFAS	441 kW		01/96→			
27.603 DFS	441 kW		01/96→			
32.293 VFC	213 kW		08/95→			
32.343 VFC	250 kW		08/95→			
32.343 VFK	250 kW		08/95→			
32.403 VFC	294 kW		08/95→			
32.403 VFK	294 kW		08/95→			
32.463 VFC	338 kW		08/95→			
32.463 VFK	338 kW		08/95→			
33.323 DFAC	235 kW		01/94→12/95			
33.323 DFAK	235 kW		01/94→12/95			
33.323 DFAS	235 kW		01/94→12/95			
33.323 DFC	235 kW		01/94→12/95			
33.323 DFK	235 kW		01/94→12/95			
33.323 DFS	235 kW		01/94→12/95			
33.343 DFAC	250 kW		01/94→			
33.343 DFAK	250 kW		01/94→			
33.343 DFAS	250 kW		01/94→			

Manufacturer - Model	Power	Displ.	Year of Constr.	Remark	Part Number	Page
MAN - F 2000						01/94→
33.343 DFC	250 kW		01/94→	Delivery Quantity [l/h]: 432; elec.; Blade Terminal; Pressure [bar]: 2.5; Pressure hose connector diameter [mm]: 11; Mono Pump; 24 V; Suction pipe connector diameter [mm]: 10.5	8TW 004 764-041 Water Pump, headlight cleaning	110
33.343 DFK	250 kW		01/94→			
33.343 DFAS	250 kW		01/94→	use plug 81.25435-0134; cap 81.26412-0013; cap 81.96410-0342 as well, according to plug connection (MAN) ; Yugoslavia: Delivery Quantity [l/h]: 432; Housing Diameter [mm]: 35; elec.; Pressure [bar]: 2.5; Pressure hose connector diameter [mm]: 11; Mono Pump; Quantity: 32; 24 V; Suction pipe connector diameter [mm]: 10.5	8TW 007 540-037 Water Pump, headlight cleaning	110
33.373 DFAC	272 kW		01/94→			
33.373 DFAK, DFA-KI	272 kW		01/94→	Front; L 600 mm; Quantity: 1	9XW 184 107-241 Wiper Blade	112
33.373 DFAS	272 kW		01/94→			
33.373 DFC	272 kW		01/94→	Front; Length [in]: 24; L 600 mm; Quantity: 1	9XW 191 397-241 Wiper Blade	114
33.373 DFK, DF-KI	272 kW		01/94→			
33.373 DFS, DFRS	272 kW		01/94→	Front; Length 1 [mm]: 600; Quantity: 1	9XW 862 056-001 Wiper Blade	119
33.403 DFAC	294 kW		01/94→			
33.403 DFAK, DFA-KI	294 kW		01/94→			
33.403 DFAS	294 kW		01/94→			
33.403 DFC	294 kW		01/94→			
33.403 DFK, DF-KI	294 kW		01/94→			
33.403 DFS, DFRS	294 kW		01/94→			
33.423 DFAC	309 kW		01/94→			
33.423 DFAK, DFA-KI	309 kW		01/94→			
33.423 DFAS	309 kW		01/94→			
33.423 DFC	309 kW		01/94→			
33.423 DFK, DF-KI	309 kW		01/94→			
33.423 DFS, DFRS	309 kW		01/94→			
33.463 DFAC	338 kW		01/94→			
33.463 DFAK, DFA-KI	338 kW		01/94→			
33.463 DFAS	338 kW		01/94→			
33.463 DFC	338 kW		01/94→			
33.463 DFK, DF-KI	338 kW		01/94→			
33.463 DFS, DFRS	338 kW		01/94→			
33.603 DFAC	441 kW		06/96→			
33.603 DFAS	441 kW		06/96→			
33.603 DFC	441 kW		06/96→			
33.603 DFS	441 kW		06/96→			
35.343 VFC	250 kW		08/95→			
35.343 VFK	250 kW		08/95→			
35.403 VF, VFC, VFRC	294 kW		08/95→			
35.403 VFK, VF-HK, VF-KI	294 kW		03/02→			
35.463 VF, VFC, VFRC	338 kW		08/95→			
35.463 VFK, VF-HK, VF-KI	338 kW		08/95→			
37.414 VFA	301 kW		06/98→			
37.464 VFA	338 kW		06/98→			
40.273 DFAC	198 kW		01/94→			
40.273 DFK	198 kW		01/94→			
40.403 DFAK	294 kW		01/94→			
40.403 DFAS	294 kW		01/94→			
40.403 DFK	294 kW		01/94→			
40.403 DFS	294 kW		01/94→			
40.463 DFAK	338 kW		01/94→			
40.463 DFAS	338 kW		01/94→			
40.463 DFK	338 kW		01/94→			
40.463 DFS	338 kW		01/94→			
41.343 VFC	250 kW		08/95→			
41.343 VFK	250 kW		08/95→			
41.403 VF, VFC, VFRC	294 kW		08/95→			
41.403 VFK, VF-HK, VF-KI	294 kW		08/95→			
41.463 VF, VFC, VFRC	338 kW		08/95→			
41.463 VFK, VF-HK, VF-KI	338 kW		08/95→			
MAN - G 90						09/87→05/95
10.150 F,10.150 FL	92 kW		05/90→10/93	Front; L 500 mm; Quantity: 1	9XW 184 107-201 Wiper Blade	112
10.150 F,10.150 FL	110 - 114 kW		09/87→10/93			
6.100 F	75 kW		09/87→10/93	Front; Length [in]: 20; L 500 mm; Quantity: 1	9XW 191 397-201 Wiper Blade	114
6.100 FK	75 kW		09/87→10/93			
8.100 F	75 kW		09/87→10/93	Front; Length 1 [mm]: 500; Quantity: 1	9XW 862 052-001 Wiper Blade	118
8.100 FK	75 kW		09/87→10/93			
8.150 F,8.150 FL	92 kW		05/90→10/93			
8.150 F,8.150 FL	110 - 114 kW		09/87→10/93			
8.150 FAE	110 - 114 kW		05/88→05/95			
8.150 FAKO	110 kW		10/92→05/95			
8.150 FK	110 - 114 kW		09/87→10/93			
8.150 FOC	110 - 114 kW		07/88→10/93			
8.150 FS,8.150 FLS	110 - 114 kW		09/87→10/93			
8.170 FOC	125 - 131 kW		02/89→10/93			
10.150 FK	110 - 114 kW		09/87→10/93	Front; L 500 mm; Quantity: 1	9XW 184 107-201 Wiper Blade	112
				Front; Length [in]: 20; L 500 mm; Quantity: 1	9XW 191 397-201 Wiper Blade	114
				05/88→; Front; Length 1 [mm]: 500; Quantity: 1	9XW 862 052-001 Wiper Blade	118

Manufacturer - Model	Power	Displ.	Year of Constr.	Remark	Part Number	Page
MAN - G 90						09/87→05/95
9.150 F,9.150 FL	92 kW		05/90→10/93	Front; L 500 mm; Quantity: 1	9XW 184 107-201	Wiper 112 Blade
9.150 FAE	110 - 114 kW		05/88→05/92	Front; Length [in]: 20; L 500 mm; Quantity: 1	9XW 191 397-201	Wiper 114 Blade
9.150 FAKO	110 kW		10/92→05/95			
9.150 FOC	110 - 114 kW		07/88→10/93	Front; L 400 mm; Length 1 [mm]: 400; Quantity: 1	9XW 862 050-001	Wiper 118 Blade
9.150 FS,9.150 FLS	110 - 114 kW		09/87→10/93			
9.170 FOC	125 - 131 kW		02/89→10/93		Front; Length 1 [mm]: 500; Quantity: 1	9XW 862 052-001
9.150 F,9.150 FL	110 - 114 kW		09/87→10/93	Front; L 500 mm; Quantity: 1	9XW 184 107-201	Wiper 112 Blade
9.150 FK	110 - 114 kW		09/87→10/93	Front; Length [in]: 20; L 500 mm; Quantity: 1	9XW 191 397-201	Wiper 114 Blade
				05/88→ ; Front; L 400 mm; Length 1 [mm]: 400; Quantity: 1	9XW 862 050-001	Wiper 118 Blade
				Front; Length 1 [mm]: 500; Quantity: 1	9XW 862 052-001	Wiper 118 Blade
MAN - G						10/79→08/88
10.136 F,10.136 FL	100 kW		09/81→09/87	Front; Length 1 [mm]: 500; Quantity: 1	9XW 862 052-001	Wiper 118 Blade
10.136 FK	100 kW		09/81→09/87			
6.90 F	66 - 66 kW		10/79→09/87			
6.90 FK	66 kW		10/79→09/87			
8.136 F,8.136 FL	100 kW		10/79→09/87			
8.136 FAE	100 kW		12/83→08/88			
8.90 F	66 kW		10/79→09/87			
8.90 FK	66 kW		10/79→09/87			
8.136 FK	100 kW		10/79→08/88			
8.136 FOC	100 kW		03/82→07/88			
9.136 F,9.136 FL	100 kW		10/79→09/87	Front; L 400 mm; Length 1 [mm]: 400; Quantity: 1	9XW 862 050-001	Wiper 118 Blade
9.136 FAE	100 kW		12/83→08/88			
9.136 FOC	100 kW		03/82→07/88			
9.136 FK	100 kW		10/79→08/88	→09/87 ; Front; L 400 mm; Length 1 [mm]: 400; Quantity: 1	9XW 862 050-001	Wiper 118 Blade
MAN - L 2000						10/93→
10.145 LC,10.145 LLC, LRC, LLRC (LE140C)	103 kW		09/00→	for headlight cleaning with telescopic jet : Delivery Quantity [l/h]: 432; elec.; Blade Terminal; Pressure [bar]: 2.5; Pressure hose connector diameter [mm]: 11; Mono Pump; 24 V; Suction pipe connector diameter [mm]: 10.5	8TW 004 764-041	Water 110 Pump, headlight cleaning
10.145 LK, LRK, L-KI, LR-KI (LE140C)	103 kW		09/00→			
10.145 LLS, LLRS (LE140C)	103 kW		09/00→	use plug 81.25435-0134; cap 81.26412-0013; cap 81.96410-0342 as well, according to plug connection (MAN) / for headlight cleaning with telescopic jet : Delivery Quantity [l/h]: 432; Housing Diameter [mm]: 35; elec.; Pressure [bar]: 2.5; Pressure hose connector diameter [mm]: 11; Mono Pump; Quantity: 32; 24 V; Suction pipe connector diameter [mm]: 10.5	8TW 007 540-037	Water 110 Pump, headlight cleaning
10.163 LC,10.163 LLC, LRC, LLRC (LE160C)	114 kW		09/00→			
10.185 LAC, LAEC, LARC, LAERC, LA-LA, LAE-LF (LE180C)	132 kW		09/00→			
10.185 LAK, LAEK, LARK, LAERK (LE180C)	132 kW		09/00→			
10.185 LC,10.185 LLC, LRC, LLRC (LE180C)	132 kW		09/00→			
10.185 LK, LRK, L-KI, LR-KI (LE180C)	132 kW		09/00→			
10.185 LLS, LLRS (LE180C)	132 kW		09/00→			
10.225 LAC, LAEC, LARC, LAERC, LA-LF, LAE-LF (LE220C)	162 kW		09/00→			
10.225 LAK, LAEK, LARK, LAERK (LE220C)	162 kW		09/00→			
10.225 LC, 10.225 LLC, LRC, LLRC	162 kW		09/00→			
10.225 LC, 10.225 LLC, LRC, LLRC (LE220C)	162 kW		09/00→			
10.225 LK, LRK, L-KI, LR-KI(LE220C)	162 kW		09/00→			
10.225 LLS, LLRS (LE220C)	162 kW		09/00→			
8.113 LC,8.113 LLC, LRC, LLRC, (LE110C)	83 kW		09/00→			
8.145 LC,8.145 LLC, L-LF (LE140C)	103 kW		09/00→			
8.145 LLS, LLRS (LE140C)	103 kW		09/00→			
8.145 LRK, L-KI, LR-KILK (LE140C)	103 kW		09/00→			
8.163 LC, 8.163 LLC (LE160C)	114 kW		09/00→			
8.185 LAC, LAEC, LARC, LAERC, LA-LF, LAE-LF (LE180C)	132 kW		09/00→			
8.185 LAK, LAEK, LARK, LAERK (LE180C)	132 kW		09/00→			

Manufacturer - Model	Power	Displ.	Year of Constr.	Remark	Part Number	Page	
MAN - L 2000						10/93→	
8.185 LC,8.185 LLC, LRC, LLRC, L-LF (LE180C)	132 kW		09/00→	for headlight cleaning with telescopic jet ; Delivery Quantity [l/h]: 432; elec.; Blade Terminal; Pressure [bar]: 2.5; Pressure hose connector diameter [mm]: 11; Mono Pump; 24 V; Suction pipe connector diameter [mm]: 10.5 use plug 81.25435-0134; cap 81.26412-0013; cap 81.96410-0342 as well, according to plug connection (MAN) / for headlight cleaning with telescopic jet ; Delivery Quantity [l/h]: 432; Housing Diameter [mm]: 35; elec.; Pressure [bar]: 2.5; Pressure hose connector diameter [mm]: 11; Mono Pump; Quantity: 32; 24 V; Suction pipe connector diameter [mm]: 10.5	8TW 004 764-041	Water 110 Pump, headlight cleaning	
8.185 LK, LRK, L-KI, LR-KI (LE180C)	132 kW		09/00→		8TW 007 540-037	Water 110 Pump, headlight cleaning	
8.185 LLS, LLRS (LE180C)	132 kW		09/00→				
8.225 LAC, LAEC, LARC, LAERC (LE220C)	162 kW		09/00→				
8.225 LAK, LAEK, LARK, LAERK (LE220C)	162 kW		09/00→				
8.225 LC,8.225 LLC, LRC, LLRC (LE220C)	162 kW		09/00→				
8.225 LK, LRK, L-KI, LR-KI (LE220C)	162 kW		09/00→				
8.225 LLS, LLRS (LE220C)	162 kW		09/00→				
9.145 LC,9.145 LLC, LRC, LLRC (LE140C)	103 kW		09/00→				
9.145 LK, LRK, L-KI, LR-KI (LE140C)	103 kW		09/00→				
9.145 LLS, LLRS (LE140C)	103 kW		09/00→				
9.185 LC,9.185 LLC, LRC, LLRC (LE180C)	132 kW		09/00→				
9.185 LK, LRK, L-KI, LR-KI (LE180C)	132 kW		09/00→				
9.185 LLS, LLRS (LE 180C)	132 kW		09/00→				
9.225 LC,9.225 LLC, LRC, LLRC (LE220C)	162 kW		09/00→				
9.225 LK, LRK, L-KI, LR-KI (LE220C)	162 kW		09/00→				
9.225 LLS, LLRS (LE220C)	162 kW		09/00→				
10.150 FOC	114 - 118 kW		02/95→01/96		for headlight cleaning with telescopic jet ; Delivery Quantity [l/h]: 432; elec.; Blade Terminal; Pressure [bar]: 2.5; Pressure hose connector diameter [mm]: 11; Mono Pump; 24 V; Suction pipe connector diameter [mm]: 10.5 use plug 81.25435-0134; cap 81.26412-0013; cap 81.96410-0342 as well, according to plug connection (MAN) / for headlight cleaning with telescopic jet ; Delivery Quantity [l/h]: 432; Housing Diameter [mm]: 35; elec.; Pressure [bar]: 2.5; Pressure hose connector diameter [mm]: 11; Mono Pump; Quantity: 32; 24 V; Suction pipe connector diameter [mm]: 10.5	8TW 004 764-041	Water 110 Pump, headlight cleaning
10.153 LC,10.153 LLC	114 kW		10/93→06/96			8TW 007 540-037	Water 110 Pump, headlight cleaning
10.153 LK	114 kW		10/93→06/96				
10.153 LLS	114 kW		10/93→06/96				
10.223 LAEC	162 kW		01/95→06/96				
10.223 LC,10.223 LLC	162 - 169 kW		10/93→06/96				
10.223 LK	162 - 169 kW		10/93→06/96				
10.223 LLS	162 - 169 kW		10/93→06/96				
8.103 LC, 8.103 LLC	75 kW		10/93→06/96				
8.103 LK	75 kW		10/93→06/96				
8.153 LAEC	114 kW		01/95→06/96				
8.153 LC,8.153 LLC	114 kW		10/93→07/97				
8.153 LK	114 kW		10/93→07/97	Front; L 500 mm; Quantity: 1		9XW 184 107-201	Wiper 112 Blade
8.163 LAEC	104 kW		08/95→03/97				
8.223 LAEC	162 kW		01/95→06/96	Front; Length [in]: 20; L 500 mm; Quantity: 1		9XW 191 397-201	Wiper 114 Blade
8.223 LC,8.223 LLC	162 - 169 kW		10/93→06/96				
9.153 LC,9.153 LLC	114 kW		10/93→06/96	Front; Length 1 [mm]: 500; Quantity: 1		9XW 862 052-001	Wiper 118 Blade
9.163 LC	104 kW		08/95→03/97				
9.163 LK	104 kW		08/95→03/97				
9.223 LC,9.223 LLC	162 - 169 kW		10/93→06/96				
9.223 LK	162 - 169 kW		10/93→06/96				
9.223 LLS	162 - 169 kW		10/93→06/96				
10.153 F	114 kW		10/93→	for headlight cleaning with telescopic jet ; Delivery Quantity [l/h]: 432; elec.; Blade Terminal; Pressure [bar]: 2.5; Pressure hose connector diameter [mm]: 11; Mono Pump; 24 V; Suction pipe connector diameter [mm]: 10.5 use plug 81.25435-0134; cap 81.26412-0013; cap 81.96410-0342 as well, according to plug connection (MAN) / for headlight cleaning with telescopic jet ; Delivery Quantity [l/h]: 432; Housing Diameter [mm]: 35; elec.; Pressure [bar]: 2.5; Pressure hose connector diameter [mm]: 11; Mono Pump; Quantity: 32; 24 V; Suction pipe connector diameter [mm]: 10.5	8TW 004 764-041	Water 110 Pump, headlight cleaning	
10.153 FA	114 kW		10/93→		8TW 007 540-037	Water 110 Pump, headlight cleaning	
10.163 F	114 kW		05/94→				
10.163 FA	114 kW		05/94→				
10.163 LAC, LAEC, LARC, LAERC	114 - 118 kW		05/94→				
10.163 LAK, LAEK, LARK, LAERK	114 - 118 kW		01/95→				
10.163 LC,10.163 LLC	114 - 118 kW		05/94→				
10.163 LK, LRK, L-KI, LR-KI	114 - 118 kW		05/94→				
10.163 LLS, LLRS	114 - 118 kW		05/94→				
10.220 FOC,10.220 FOCL	162 kW		02/95→				
10.223 F, 10.223 FL	162 kW		10/93→06/96		-08/01; Front; L 500 mm; Quantity: 1	9XW 184 107-201	Wiper 112 Blade
10.223 FA	162 kW		10/93→06/96				
10.224 F, 10.224 FL	162 kW		05/94→		-08/01; Front; Length [in]: 20; L 500 mm; Quantity: 1	9XW 191 397-201	Wiper 114 Blade
10.224 FA	162 kW		05/94→				
10.224 LAC, LAEC, LARC, LAERC	162 kW		01/95→		-08/01; Front; Length 1 [mm]: 500; Quantity: 1	9XW 862 052-001	Wiper 118 Blade
10.224 LAK, LAEK, LARK, LAERK	162 kW		01/95→				
10.224 LC,10.224 LLC, LRC, LLRC	162 kW		05/94→				
10.224 LK, LRK, L-KI, LR-KI	162 kW		05/94→				
10.224 LLS, LLRS	162 kW		05/94→				
12.185 LC, LLC (LE180C)	132 kW		09/99→				
12.225 LC, LLC (LE220C)	162 kW		09/99→				
8.113 LC, 8.113 LLC	81 kW		08/95→				
8.113 LK, LRK, L-KI, LR-KI	81 kW		08/95→				
8.150 FOC,8.150 FOCL	114 - 118 kW		02/95→				

Manufacturer - Model	Power	Displ.	Year of Constr.	Remark	Part Number	Page						
MAN - L 2000						10/93→						
8.163 LAC, LAEC, LARC, LAERC, LA-LF, LAE-LF	114 - 118 kW		01/95→	for headlight cleaning with telescopic jet ; Delivery Quantity [l/h]: 432; elec.; Blade Terminal; Pressure [bar]: 2.5; Pressure hose connector diameter [mm]: 11; Mono Pump; 24 V; Suction pipe connector diameter [mm]: 10.5	8TW 004 764-041 Water Pump, headlight cleaning	110						
8.163 LC,8.163 LLC	114 - 118 kW		05/94→									
8.163 LC,8.163 LLC, LRC, LLRC, L-LF	104 kW		08/95→	use plug 81.25435-0134; cap 81.26412-0013; cap 81.96410-0342 as well, according to plug connection (MAN) / for headlight cleaning with telescopic jet ; Delivery Quantity [l/h]: 432; Housing Diameter [mm]: 35; elec.; Pressure [bar]: 2.5; Pressure hose connector diameter [mm]: 11; Mono Pump; Quantity: 32; 24 V; Suction pipe connector diameter [mm]: 10.5	8TW 007 540-037 Water Pump, headlight cleaning	110						
8.163 LK, LRK, L-KI, LR-KI	114 - 118 kW		05/94→									
8.163 LLS, LLRS	114 - 118 kW		05/94→									
8.220 FOC,8.220 FOCL	162 kW		04/95→									
8.224 LAC, LAEC, LARC, LAERC	162 kW		01/95→									
8.224 LAK, LAEK, LARK, LAERK	162 kW		01/95→									
8.224 LC,8.224 LLC, LRC, LLRC	162 kW		05/94→									
8.224 LK, LRK, L-KI, LR-KI	162 kW		05/94→									
8.224 LLS, LLRS	162 kW		05/94→									
9.163 LC,9.163 LLC, LRC, LLRC	114 - 118 kW		05/94→									
9.163 LK, LRK, L-KI, LR-KI	114 - 118 kW		05/94→	→08/01; Front; Length [in]: 20; L 500 mm; Quantity: 1	9XW 184 107-201 Wiper Blade	112						
9.163 LLS, LLRS	114 - 118 kW		05/94→	→08/01; Front; Length [in]: 20; L 500 mm; Quantity: 1	9XW 191 397-201 Wiper Blade	114						
9.224 LC,9.224 LLC, LRC, LLRC	162 kW		05/94→	→08/01; Front; Length 1 [mm]: 500; Quantity: 1	9XW 862 052-001 Wiper Blade	118						
9.224 LK, LRK, L-KI, LR-KI	162 kW		05/94→									
9.224 LLS, LLRS	162 kW		05/94→									
10.153 LAEK	114 kW		10/93→06/96	for headlight cleaning with telescopic jet ; Delivery Quantity [l/h]: 432; elec.; Blade Terminal; Pressure [bar]: 2.5; Pressure hose connector diameter [mm]: 11; Mono Pump; 24 V; Suction pipe connector diameter [mm]: 10.5	8TW 004 764-041 Water Pump, headlight cleaning	110						
8.153 LLS	114 kW		10/93→06/96									
9.153 LK	114 kW		10/93→06/96	use plug 81.25435-0134; cap 81.26412-0013; cap 81.96410-0342 as well, according to plug connection (MAN) / for headlight cleaning with telescopic jet ; Delivery Quantity [l/h]: 432; Housing Diameter [mm]: 35; elec.; Pressure [bar]: 2.5; Pressure hose connector diameter [mm]: 11; Mono Pump; Quantity: 32; 24 V; Suction pipe connector diameter [mm]: 10.5	8TW 007 540-037 Water Pump, headlight cleaning	110						
9.153 LLS	114 kW		10/93→12/95									
							Front; L 500 mm; Quantity: 1	9XW 184 107-201 Wiper Blade	112			
							Front; Length [in]: 20; L 500 mm; Quantity: 1	9XW 191 397-201 Wiper Blade	114			
							01/95→; Front; Length 1 [mm]: 500; Quantity: 1	9XW 862 052-001 Wiper Blade	118			
8.153 LAEK	114 kW		01/95→09/96	for headlight cleaning with telescopic jet ; Delivery Quantity [l/h]: 432; elec.; Blade Terminal; Pressure [bar]: 2.5; Pressure hose connector diameter [mm]: 11; Mono Pump; 24 V; Suction pipe connector diameter [mm]: 10.5	8TW 004 764-041 Water Pump, headlight cleaning	110						
							use plug 81.25435-0134; cap 81.26412-0013; cap 81.96410-0342 as well, according to plug connection (MAN) / for headlight cleaning with telescopic jet ; Delivery Quantity [l/h]: 432; Housing Diameter [mm]: 35; elec.; Pressure [bar]: 2.5; Pressure hose connector diameter [mm]: 11; Mono Pump; Quantity: 32; 24 V; Suction pipe connector diameter [mm]: 10.5	8TW 007 540-037 Water Pump, headlight cleaning	110			
										Front; L 500 mm; Quantity: 1	9XW 184 107-201 Wiper Blade	112
										Front; Length [in]: 20; L 500 mm; Quantity: 1	9XW 191 397-201 Wiper Blade	114
										→06/96; Front; Length 1 [mm]: 500; Quantity: 1	9XW 862 052-001 Wiper Blade	118
8.223 LK	162 - 169 kW		10/93→06/96	for headlight cleaning with telescopic jet ; Delivery Quantity [l/h]: 432; elec.; Blade Terminal; Pressure [bar]: 2.5; Pressure hose connector diameter [mm]: 11; Mono Pump; 24 V; Suction pipe connector diameter [mm]: 10.5	8TW 004 764-041 Water Pump, headlight cleaning	110						
8.223 LLS	162 - 169 kW		10/93→06/96									
				use plug 81.25435-0134; cap 81.26412-0013; cap 81.96410-0342 as well, according to plug connection (MAN) / for headlight cleaning with telescopic jet ; Delivery Quantity [l/h]: 432; Housing Diameter [mm]: 35; elec.; Pressure [bar]: 2.5; Pressure hose connector diameter [mm]: 11; Mono Pump; Quantity: 32; 24 V; Suction pipe connector diameter [mm]: 10.5	8TW 007 540-037 Water Pump, headlight cleaning	110						
							Front; L 500 mm; Quantity: 1	9XW 184 107-201 Wiper Blade	112			
							Front; Length [in]: 20; L 500 mm; Quantity: 1	9XW 191 397-201 Wiper Blade	114			
							→01/95; Front; Length 1 [mm]: 500; Quantity: 1	9XW 862 052-001 Wiper Blade	118			

Manufacturer - Model	Power	Displ.	Year of Constr.	Remark	Part Number	Page
MAN - LION S COACH						09/95→
FRH 352,RH 353	257 kW		09/95→	Delivery Quantity [l/h]: 432; elec.; Blade Terminal; Pressure [bar]: 2.5; Pressure hose connector diameter [mm]: 11; Mono Pump; 24 V; Suction pipe connector diameter [mm]: 10.5	8TW 004 764-041	Water 110 Pump, headlight cleaning
FRH 402,RH 403	294 kW		09/95→			
RH 402	294 kW		09/98→			
RH 413	301 kW		01/00→			
				use plug 81.25435-0134; cap 81.26412-0013; cap 81.96410-0342 as well, according to plug connection (MAN) ; Delivery Quantity [l/h]: 432; Housing Diameter [mm]: 35; elec.; Pressure [bar]: 2.5; Pressure hose connector diameter [mm]: 11; Mono Pump; Quantity: 32; 24 V; Suction pipe connector diameter [mm]: 10.5	8TW 007 540-037	Water 110 Pump, headlight cleaning
				09/02→ ; Front; L 1,000 mm; Quantity: 1	9XW 184 107-401	Wiper 113 Blade
RH 463, RHC 464	338 kW		01/00→	Delivery Quantity [l/h]: 432; elec.; Blade Terminal; Pressure [bar]: 2.5; Pressure hose connector diameter [mm]: 11; Mono Pump; 24 V; Suction pipe connector diameter [mm]: 10.5	8TW 004 764-041	Water 110 Pump, headlight cleaning
RHC 414	301 kW		06/02→			
				use plug 81.25435-0134; cap 81.26412-0013; cap 81.96410-0342 as well, according to plug connection (MAN) ; Delivery Quantity [l/h]: 432; Housing Diameter [mm]: 35; elec.; Pressure [bar]: 2.5; Pressure hose connector diameter [mm]: 11; Mono Pump; Quantity: 32; 24 V; Suction pipe connector diameter [mm]: 10.5	8TW 007 540-037	Water 110 Pump, headlight cleaning
				09/02→ ; Front; L 1,000 mm; Quantity: 1	9XW 184 107-401	Wiper 113 Blade
				09/02→ ; -09/06 ; Front; Length [in]: 40; L 1,000 mm; Quantity: 1	9XW 191 397-401	Wiper 116 Blade
				09/02→ ; -09/06 ; Front; Length [in]: 40; L 1,000 mm; Quantity: 1	9XW 194 562-401	Wiper 117 Blade
MAN - LION S COMFORT						09/96→
RN 313	228 kW		09/96→	Delivery Quantity [l/h]: 432; elec.; Blade Terminal; Pressure [bar]: 2.5; Pressure hose connector diameter [mm]: 11; Mono Pump; 24 V; Suction pipe connector diameter [mm]: 10.5	8TW 004 764-041	Water 110 Pump, headlight cleaning
RN 353	257 kW		06/97→			
				use plug 81.25435-0134; cap 81.26412-0013; cap 81.96410-0342 as well, according to plug connection (MAN) ; Delivery Quantity [l/h]: 432; Housing Diameter [mm]: 35; elec.; Pressure [bar]: 2.5; Pressure hose connector diameter [mm]: 11; Mono Pump; Quantity: 32; 24 V; Suction pipe connector diameter [mm]: 10.5	8TW 007 540-037	Water 110 Pump, headlight cleaning
MAN - LION S STAR						01/93→
FRH 352,RH 353	257 kW		09/95→	Delivery Quantity [l/h]: 432; elec.; Blade Terminal; Pressure [bar]: 2.5; Pressure hose connector diameter [mm]: 11; Mono Pump; 24 V; Suction pipe connector diameter [mm]: 10.5	8TW 004 764-041	Water 110 Pump, headlight cleaning
FRH 402,RH 403	294 kW		09/95→			
FRH 422	309 kW		01/93→09/96			
RH 464, RHS 464	301 kW		03/00→			
RH 464, RHS 464	301 kW		01/02→			
RH 414	338 kW		03/00→			
RH 464, RHS 464	338 kW		01/02→			
				use plug 81.25435-0134; cap 81.26412-0013; cap 81.96410-0342 as well, according to plug connection (MAN) ; Delivery Quantity [l/h]: 432; Housing Diameter [mm]: 35; elec.; Pressure [bar]: 2.5; Pressure hose connector diameter [mm]: 11; Mono Pump; Quantity: 32; 24 V; Suction pipe connector diameter [mm]: 10.5	8TW 007 540-037	Water 110 Pump, headlight cleaning
MAN - M 90						08/88→06/96
12.152 F,12.152 FL	110 - 114 kW		12/88→05/94	Front; L 600 mm; Quantity: 1	9XW 184 107-241	Wiper 112 Blade
12.152 FK	110 - 114 kW		12/88→05/94			
12.152 FS,12.152 FLS	110 - 114 kW		12/88→05/94			
12.192 F,12.192 FL	140 kW		07/90→06/96			
12.192 FA	140 kW		10/92→06/96			
12.192 FAK	140 kW		10/92→06/96			
12.192 FK	140 kW		07/90→06/96			
12.192 FS,12.192 FLS	140 kW		07/90→06/96			
12.222 F,12.222 FL	162 kW		05/94→06/96			
12.222 FA	162 kW		05/94→06/96			
12.222 FAK	162 kW		05/94→06/96			
12.222 FK	162 kW		05/94→06/96			
12.222 FLS	162 kW		05/94→06/96			
12.232 F,12.232 FL	169 kW		08/88→06/96			
12.232 FA	169 kW		05/90→06/96			
12.232 FAK	169 kW		05/90→06/96			
12.232 FK	169 kW		08/88→06/96			
12.232 FS,12.232 FLS	169 kW		08/88→06/96			
12.262 F,12.262 FL	191 kW		08/95→06/96			
12.262 FK	191 kW		08/95→06/96			
12.262 FS,12.262 FLS	191 kW		08/95→06/96			
12.272 F,12.272 FL	198 kW		09/91→10/92			
12.272 F,12.272 FL	198 kW		10/92→06/96			
12.272 FA	198 kW		10/93→04/95			
12.272 FAK	198 kW		10/93→04/95			
12.272 FK	198 kW		09/91→10/92			

Manufacturer - Model	Power	Displ.	Year of Constr.	Remark	Part Number	Page
MAN - M 90						08/88→06/96
12.272 FK	198 kW		10/92→06/96	Front; L 600 mm; Quantity: 1	9XW 184 107-241 Wiper 112 Blade	
12.272 FS,12.272 FLS	198 kW		09/91→10/92			
12.272 FS,12.272 FLS	198 kW		10/92→06/96			
14.152 F,14.152 FL	110 - 114 kW		12/88→04/94			
14.152 F,14.152 FL	114 kW		05/94→06/96			
14.152 FK	110 - 114 kW		12/88→05/94			
14.152 FK	114 kW		05/94→06/96			
14.152 FS,14.152 FLS	110 - 114 kW		12/88→05/94			
14.152 FS,14.152 FLS	114 kW		05/94→06/96			
14.162 F,14.162 FL	118 kW		08/95→06/96			
14.162 FK	118 kW		08/95→06/96			
14.162 FS,14.162 FLS	118 kW		08/95→06/96			
14.192 F,14.192 FL	137 kW		08/88→06/90			
14.192 F,14.192 FL	140 kW		07/90→06/96			
14.192 FA	137 kW		08/88→06/90			
14.192 FK	137 kW		08/88→06/90			
14.192 FK	140 kW		07/90→06/96			
14.192 FS,14.192 FLS	137 kW		08/88→06/90			
14.192 FS,14.192 FLS	140 kW		07/90→06/96			
14.222 F,14.222 FL	162 kW		05/94→06/96			
14.222 FK	162 kW		05/94→06/96			
14.222 FLS	162 kW		05/94→06/96			
14.232 F,14.232 FL	160 kW		05/90→04/95			
14.232 F,14.232 FL	169 kW		08/88→06/96			
14.232 FK	169 kW		08/88→06/96			
14.232 FS,14.232 FLS	160 kW		05/90→04/95			
14.232 FS,14.232 FLS	169 kW		08/88→06/96			
14.262 F,14.262 FL	191 kW		08/95→06/96			
14.262 FK	191 kW		08/95→06/96			
14.262 FS,14.262 FLS	191 kW		08/95→06/96			
14.272 F,14.272 FL	198 kW		09/91→10/92			
14.272 F,14.272 FL	198 kW		10/92→06/96			
14.272 FK	198 kW		09/91→10/92			
14.272 FK	198 kW		10/92→06/96			
14.272 FS,14.272 FLS	198 kW		09/91→10/92			
14.272 FS,14.272 FLS	198 kW		12/92→06/96			
17.192 F,17.192 FL	137 kW		08/88→06/90			
17.192 F,17.192 FL	140 kW		07/90→04/95			
17.192 FA	137 kW		02/89→06/90			
17.192 FA	140 kW		07/90→06/96			
17.192 FAK	137 kW		02/89→06/90			
17.192 FAK	140 kW		07/90→06/96			
17.192 FK	137 kW		08/88→06/90			
17.192 FK	140 kW		07/90→01/91			
17.192 FS,17.192 FLS	137 kW		08/88→06/90			
17.192 FS,17.192 FLS	140 kW		07/90→04/95			
17.222 FA	162 kW		05/94→06/96			
17.222 FAK	162 kW		05/94→06/96			
17.232 F,17.232 FL	160 kW		05/90→04/95			
17.232 F,17.232 FL	169 kW		08/88→04/95			
17.232 FA	160 kW		05/90→04/95			
17.232 FA	169 kW		02/89→06/96			
17.232 FAK	160 kW		05/90→04/95			
17.232 FAK	169 kW		02/89→06/96			
17.232 FK	160 kW		05/90→01/91			
17.232 FK	169 kW		08/88→01/91			
17.232 FS,17.232 FLS	160 kW		05/90→04/95			
17.232 FS,17.232 FLS	169 kW		08/88→04/95			
17.272 FLS	198 kW		09/91→05/95			
17.272 FLS	198 kW		10/92→05/95			
18.192 F,18.192 FL,18.192 FLL	140 kW		09/90→06/96			
18.192 FK	140 kW		09/90→06/96			
18.222 F,18.222 FL,18.222 FLL	162 kW		05/94→06/96			
18.222 FK	162 kW		05/94→06/96			
18.232 F,18.232 FL,18.232 FLL	169 kW		09/90→06/96			
18.232 FK	169 kW		09/90→06/96			
18.262 F,18.262 FL,18.262 FLL	191 kW		08/95→06/96			
18.262 FK	191 kW		08/95→06/96			
18.272 F,18.272 FL,18.272 FLL	198 kW		09/91→05/94			
18.272 F,18.272 FL,18.272 FLL	198 kW		10/92→06/96			
18.272 FK	198 kW		09/91→05/94			
18.272 FK	198 kW		10/92→06/96			
24.222 FNL,24.222 FNLL,24.222 FVL	162 kW		05/94→06/96			
24.232 FNL	160 kW		05/90→04/95			
24.232 FNL,24.232 FNLL,24.232 FVL	169 kW		07/89→06/96			
24.262 FNL,24.262 FNLL,24.262 FVL	191 kW		08/95→06/96			
24.272 FNL,24.272 FNLL,24.272 FVL	198 kW		10/92→06/96			

Manufacturer - Model	Power	Displ.	Year of Constr.	Remark	Part Number	Page
MAN - M 90						08/88→06/96
24.272 FNL,24.272 FVL	198 kW		09/91→05/94	Front; L 600 mm; Quantity: 1	9XW 184 107-241 Wiper 112 Blade	
24.192 FNL,24.192 FNLL,24.192 FVL	140 kW		07/89→06/96	Front; L 600 mm; Quantity: 1	9XW 184 107-241 Wiper 112 Blade	
				Front; Length [in]: 24; L 600 mm; Quantity: 1	9XW 191 397-241 Wiper 114 Blade	
				Front; Length 1 [mm]: 600; Quantity: 1	9XW 862 056-001 Wiper 119 Blade	
MAN - M 2000 L						08/95→
12.145 LC, LLC, LRC, LLRC	107 kW		05/01→	Front; L 500 mm; Quantity: 1	9XW 184 107-201 Wiper 112 Blade	
12.145 LK, LRK	107 kW		05/01→	Front; L 600 mm; Quantity: 1	9XW 184 107-241 Wiper 112 Blade	
12.185 LC, LLC, LRC, LLRC	132 - 136 kW		05/01→			
12.185 LK, LRK	132 - 136 kW		05/01→			
12.225 LC, LLC, LLLC, LRC, LLRC	162 kW		05/01→			
12.255 LC, LLC, LLLC	180 kW		08/02→			
12.255 LK	180 kW		10/03→			
12.285 LC, LLC, LLLC	206 kW		08/02→			
12.285 LK	206 kW		10/03→			
14.185 LC, LLC, LRC, LLRC	132 - 136 kW		05/01→			
14.185 LK, LRK	132 - 136 kW		05/01→			
14.224, 14.225, LA-LF	162 kW		07/03→			
14.255 LAC, LARC	180 kW		11/02→			
14.255 LAK, LARK	180 kW		11/02→			
14.255 LA-LF	180 kW		07/03→			
14.255 LK, LRK	180 kW		11/02→			
14.264 LA-LF	191 kW		07/03→			
15.185 LC, LRC	132 - 136 kW		05/01→			
15.185 LK, LRK	132 - 136 kW		11/02→			
18.224, 18.225, L-KO, LR-KO	162 kW		05/01→			
18.255 LAC, LARC	180 kW		05/01→			
18.255 LAK, LARK	180 kW		05/01→			
18.255 LK, LK, LRK, LLRK	180 kW		11/02→			
18.255 L-KO, LR-KO	180 kW		05/01→			
18.263, 18.264, L-KO, LR-KO	191 kW		05/01→			
19.224, 19.225, LLC	162 kW		05/01→			
19.255 LLC	180 kW		05/01→			
19.264 LLC	191 kW		05/01→			
19.284, 19.285, LLC	206 kW		05/01→			
20.224 LNLC, LNLLC	162 kW		05/01→			
20.255 LNLC, LNLLC	180 kW		05/01→			
20.264 LNLC, LNLLC	191 kW		05/01→			
20.284, 20.285, LNLC, LNLLC	206 kW		05/01→			
26.224, 26.225, DL-HK, DLR-HK	180 kW		11/02→			
26.255 DL-HK, DLR-HK	180 kW		11/02→			
26.284, 26.285, DL-HK, DLR-HK	206 kW		11/02→			
26.284 DL-TM, DLR-TM	206 kW		05/01→			
12.163 LC, LLC, LRC, LLRC	114 kW		08/95→	for headlight cleaning with telescopic jet ; Delivery Quantity [l/h]: 432; elec.; Blade Terminal; Pressure [bar]: 2.5; Pressure hose connector diameter [mm]: 11; Mono Pump; 24 V; Suction pipe connector diameter [mm]: 10.5	8TW 004 764-041 Water 110 Pump, headlight cleaning	
12.163 LK, LRK	114 kW		08/95→			
12.224, 12.225, LK, LRK	162 kW		08/95→	use plug 81.25435-0134; cap 81.26412-0013; cap 81.96410-0342 as well, according to plug connection (MAN) / for headlight cleaning with telescopic jet ; Delivery Quantity [l/h]: 432; Housing Diameter [mm]: 35; elec.; Pressure [bar]: 2.5; Pressure hose connector diameter [mm]: 11; Mono Pump; Quantity: 32; 24 V; Suction pipe connector diameter [mm]: 10.5	8TW 007 540-037 Water 110 Pump, headlight cleaning	
12.224 LC, LLC, LRC, LLRC	162 kW		08/95→			
18.224, 18.225, LAC, LARC	162 kW		08/95→			
18.224, 18.225, LAK, LARK	162 kW		08/95→			
18.224, 18.225, LC, LLC, LLLC, LRC, LLRC, LLLRC	162 kW		08/95→			
18.224, 18.225, LK, LK, LRK, LLRK	162 kW		08/95→			
18.255 LC, LLC, LLLC, LRC, LLRC, LLLRC, (LE250B)	180 kW		09/99→	Front; L 500 mm; Quantity: 1	9XW 184 107-201 Wiper 112 Blade	
18.263, 18.264, LAC, LARC	191 kW		08/95→			
18.263, 18.264, LAK, LARK	191 kW		08/95→			
18.263, 18.264, LC, LLC, LLLC, LRC, LLRC, LLLRC	191 kW		08/95→	--08/01; Front; L 500 mm; Quantity: 1	9XW 184 107-201 Wiper 112 Blade	
18.263, 18.264, LK, LK, LRK, LLRK	191 kW		08/95→	Front; L 600 mm; Quantity: 1	9XW 184 107-241 Wiper 112 Blade	
18.284, 18.285, LK, LK, LRK, LLRK	206 kW		06/98→	--09/01; Front; L 600 mm; Quantity: 1	9XW 184 107-241 Wiper 112 Blade	
18.284, 18.285, L-KO, LR-KO	206 kW		06/98→			
18.284 LAC, LARC	206 kW		06/98→	--08/01; Front; Length [in]: 20; L 500 mm; Quantity: 1	9XW 191 397-201 Wiper 114 Blade	
18.284 LAK, LARK	206 kW		06/98→			
18.284 LC, LLC, LLLC, LRC, LLRC, LLLRC	206 kW		06/98→	--09/01; Front; Length [in]: 24; L 600 mm; Quantity: 1	9XW 191 397-241 Wiper 114 Blade	
18.285 LAC, LARC (LE280B)	206 kW		09/99→	--08/01; Front; Length 1 [mm]: 500; Quantity: 1	9XW 862 052-001 Wiper 118 Blade	
18.285 LAK, LARK, (LE280B)	206 kW		09/99→			
18.285 LC, LLC, LLLC, LRC, LLRC, LLLRC, (LE280B)	206 kW		09/99→	--09/01; Front; Length 1 [mm]: 600; Quantity: 1	9XW 862 056-001 Wiper 119 Blade	

Manufacturer - Model	Power	Displ.	Year of Constr.	Remark	Part Number	Page
MAN - M 2000 L						08/95→
14.163 LC, LLC, LRC, LLRC	114 kW		08/95→	for headlight cleaning with telescopic jet ; Delivery Quantity [l/h]: 432; elec.; Blade Terminal; Pressure [bar]: 2.5; Pressure hose connector diameter [mm]: 11; Mono Pump; 24 V; Suction pipe connector diameter [mm]: 10.5	8TW 004 764-041 Water Pump, headlight cleaning	110
14.163 LK, LRK	114 kW		08/95→			
14.224 LAC, LARC	162 kW		08/95→	use plug 81.25435-0134; cap 81.26412-0013; cap 81.96410-0342 as well, according to plug connection (MAN) / for headlight cleaning with telescopic jet ; Delivery Quantity [l/h]: 432; Housing Diameter [mm]: 35; elec.; Pressure [bar]: 2.5; Pressure hose connector diameter [mm]: 11; Mono Pump; Quantity: 32; 24 V; Suction pipe connector diameter [mm]: 10.5	8TW 007 540-037 Water Pump, headlight cleaning	110
14.224 LAK, LARK	162 kW		08/95→			
14.224 LC, LLC, LLLC, LRC, LLRC, LLLRC	162 kW		08/95→	Front; L 500 mm; Quantity: 1	9XW 184 107-201 Wiper Blade	112
14.224 LK, LRK	162 kW		08/95→			
14.263, 14.264 LAC, LARC	191 kW		08/95→	-08/01; Front; L 500 mm; Quantity: 1	9XW 184 107-201 Wiper Blade	112
14.263, 14.264 LAK, LARK	191 kW		08/95→			
14.263, 14.264 LC, LLC, LLLC, LRC, LLRC, LLLRC	191 kW		08/95→	Front; L 600 mm; Quantity: 1	9XW 184 107-241 Wiper Blade	112
14.263, 14.264 LK, LRK	191 kW		08/95→			
14.284, 14.285, LAC, LARC	206 kW		06/98→	-08/01; Front; Length [in]: 20; L 500 mm; Quantity: 1	9XW 191 397-201 Wiper Blade	114
14.284, 14.285, LAK, LARK	206 kW		06/98→			
14.284, 14.285, LA-LF	206 kW		06/98→	-08/01; Front; Length 1 [mm]: 500; Quantity: 1	9XW 862 052-001 Wiper Blade	118
14.284, 14.285, LK, LRK	206 kW		10/98→			
14.284 LC, LLC, LLLC, LRC, LLRC, LLLRC	206 kW		10/98→			
15.163 LC, LLC, LRC	114 kW		08/95→			
15.163 LK, LRK	114 kW		08/95→			
15.224 LC, LLC, LLLC, LRC, LLRC, LLLRC	162 kW		08/95→			
15.224 LK, LRK	162 kW		08/95→			
15.225 LC, LLC, LLLC, LRC, LLRC, LLLRC, (LE220B)	162 kW		09/99→			
15.225 LK, LRK, (LE220B)	162 kW		09/99→			
15.255 LC, LLC, LLLC, LRC, LLRC, LLLRC, (LE250B)	180 kW		09/99→			
15.255 LK, LRK, (LE250B)	180 kW		09/99→			
15.263, 15.264 LC, LLC, LLLC, LRC, LLRC, LLLRC	191 kW		08/95→			
15.263, 15.264 LK, LRK	191 kW		08/95→			
15.284 LC, LLC, LLLC, LRC, LLRC, LLLRC	206 kW		06/98→			
15.284 LK, LRK	206 kW		06/98→			
15.285 LC, LLC, LLLC, LRC, LLRC, LLLRC, (LE280B)	206 kW		09/99→			
15.285 LK, LRK, (LE280B)	206 kW		09/99→			
14.225 LAC, LARC, (LE220B)	162 kW		09/00→	for headlight cleaning with telescopic jet ; Delivery Quantity [l/h]: 432; elec.; Blade Terminal; Pressure [bar]: 2.5; Pressure hose connector diameter [mm]: 11; Mono Pump; 24 V; Suction pipe connector diameter [mm]: 10.5	8TW 004 764-041 Water Pump, headlight cleaning	110
14.225 LAK, LARK, (LE220B)	162 kW		09/00→			
14.225 LC, LLC, LLLC, LRC, LLRC, LLLRC, (LE220B)	162 kW		09/00→	use plug 81.25435-0134; cap 81.26412-0013; cap 81.96410-0342 as well, according to plug connection (MAN) / for headlight cleaning with telescopic jet ; Delivery Quantity [l/h]: 432; Housing Diameter [mm]: 35; elec.; Pressure [bar]: 2.5; Pressure hose connector diameter [mm]: 11; Mono Pump; Quantity: 32; 24 V; Suction pipe connector diameter [mm]: 10.5	8TW 007 540-037 Water Pump, headlight cleaning	110
14.225 LK, LRK (LE220B)	162 kW		09/00→			
14.255 LC, LLC, LLLC, LRC, LLRC, LLLRC, (LE250B)	180 kW		09/00→			
14.285 LC, LLC, LLLC, LRC, LLRC, LLLRC, (LE280B)	206 kW		09/00→			
MAN - M 2000 M						08/95→
12.224 MC, MLC	162 kW		02/03→	use plug 81.25435-0134; cap 81.26412-0013; cap 81.96410-0342 as well, according to plug connection (MAN) ; Delivery Quantity [l/h]: 432; Housing Diameter [mm]: 35; elec.; Pressure [bar]: 2.5; Pressure hose connector diameter [mm]: 11; Mono Pump; Quantity: 32; 24 V; Suction pipe connector diameter [mm]: 10.5	8TW 007 540-037 Water Pump, headlight cleaning	110
12.224 MLS	162 kW		02/03→			
12.255 MC, MLC	180 kW		02/03→	Front; L 500 mm; Quantity: 1	9XW 184 107-201 Wiper Blade	112
12.255 MLS	180 kW		02/03→			
12.264 MC, MLC	191 kW		02/03→			
12.264 MLS	191 kW		02/03→			
14.224 MA-KO, MA-LF	162 kW		11/02→			
14.225 MC, MLC, MLLC	162 kW		10/00→			
14.225 MLS, MLRS	162 kW		02/03→			
14.255 MAK	180 kW		11/02→			
14.255 MA-KO, MA-LF	180 kW		11/02→			
14.264 MAK	191 kW		11/02→			
14.264 MA-KO, MA-LF	191 kW		11/02→			
14.285 MLS, MLRS	206 kW		02/03→			
18.225 MAC, MARC	162 kW		02/03→			
18.225 MC, MLC, MLLC, MRC, MLRC, MLLRC	162 kW		10/00→			
18.255 MK, MLK, MRK, MLRK	180 kW		11/02→			
18.285 MAC, MARC	206 kW		02/03→			
18.285 MC, MLC, MLLC	206 kW		06/98→12/05			
18.285 MLS, MLRS	206 kW		02/03→			

Manufacturer - Model	Power	Displ.	Year of Constr.	Remark	Part Number	Page
MAN - M 2000 M						08/95→
25.225 MNLC, MNLLC, MNLRC, MNLLRC, MVLC	162 kW		02/03→	use plug 81.25435-0134; cap 81.26412-0013; cap 81.96410-0342 as well, according to plug connection (MAN) ; Delivery Quantity [l/h]: 432; Housing Diameter [mm]: 35; elec.; Pressure [bar]: 2.5; Pressure hose connector diameter [mm]: 11; Mono Pump; Quantity: 32; 24 V; Suction pipe connector diameter [mm]: 10.5	8TW 007 540-037 Water Pump, headlight cleaning	110
25.285 MNLC, MNLLC, MNLRC, MNLLRC, MVLC	206 kW		02/03→			
12.284 MC, MLC	206 kW		02/00→	use plug 81.25435-0134; cap 81.26412-0013; cap 81.96410-0342 as well, according to plug connection (MAN) ; Delivery Quantity [l/h]: 432; Housing Diameter [mm]: 35; elec.; Pressure [bar]: 2.5; Pressure hose connector diameter [mm]: 11; Mono Pump; Quantity: 32; 24 V; Suction pipe connector diameter [mm]: 10.5	8TW 007 540-037 Water Pump, headlight cleaning	110
12.284 MLS	206 kW		02/00→			
14.224 MC, MLC, MLLC	162 kW		08/95→12/05	Front; L 500 mm; Quantity: 1	9XW 184 107-201 Wiper Blade	112
14.255 MC, MLC, MLLC	180 kW		10/00→			
14.255 MLS, MLRS	180 kW		10/00→	Front; L 500 mm; Quantity: 1	9XW 184 107-201 Wiper Blade	112
18.224 MAC, MARC	162 kW		08/95→12/05			
18.224 MAK, MARK	162 kW		08/95→12/05	Front; L 500 mm; Quantity: 1	9XW 184 107-201 Wiper Blade	112
18.224 MC, MLC, MLLC, MRC, MLRC, MLLRC	162 kW		08/95→12/05			
18.224 MK, 18.224 MLK, MRK, MLRK	162 kW		08/95→12/05	→09/01; Front; L 600 mm; Quantity: 1	9XW 184 107-241 Wiper Blade	112
18.224 M-KO, MR-KO	162 kW		02/00→	→09/01; Front; Length [in]: 24; L 600 mm; Quantity: 1	9XW 191 397-241 Wiper Blade	114
18.224 MLS, MLRS	162 kW		08/95→12/05			
18.255 MAC, MARC	180 kW		10/00→	→09/01; Front; Length 1 [mm]: 600; Quantity: 1	9XW 862 056-001 Wiper Blade	119
18.255 MAK, MARK	180 kW		10/00→			
18.255 MC, MLC, MLLC, MLRC, MLLRC	180 kW		10/00→	→09/01; Front; Length 1 [mm]: 600; Quantity: 1	9XW 862 056-001 Wiper Blade	119
18.255 M-KO, MR-KO	180 kW		10/00→			
18.255 MLS, MLRS	180 kW		10/00→	→09/01; Front; Length 1 [mm]: 600; Quantity: 1	9XW 862 056-001 Wiper Blade	119
18.264 MAC, MARC	191 kW		08/95→12/05			
18.264 MAK, MARK	191 kW		08/95→12/05	→09/01; Front; Length 1 [mm]: 600; Quantity: 1	9XW 862 056-001 Wiper Blade	119
18.264 MC, MLC, MLLC, MRC, MLRC, MLLRC	191 kW		08/95→12/05			
18.264 MK, 18.264 MLK, MRK, MLRK	191 kW		08/95→12/05	→09/01; Front; Length 1 [mm]: 600; Quantity: 1	9XW 862 056-001 Wiper Blade	119
18.264 M-KO, MR-KO	191 kW		02/00→			
18.264 MLS, MLRS	191 kW		08/95→12/05	→09/01; Front; Length 1 [mm]: 600; Quantity: 1	9XW 862 056-001 Wiper Blade	119
18.284 MAC, MARC	206 kW		06/98→12/05			
18.284 MAK, MARK	206 kW		06/98→12/05	→09/01; Front; Length 1 [mm]: 600; Quantity: 1	9XW 862 056-001 Wiper Blade	119
18.284 MC, MLC, MLLC, MRC, MLRC, LLRC	206 kW		06/98→12/05			
18.284 MK, 18.284 MLK, MRK, MLRK	206 kW		06/98→12/05	→09/01; Front; Length 1 [mm]: 600; Quantity: 1	9XW 862 056-001 Wiper Blade	119
18.284 M-KO, MR-KO	206 kW		02/00→			
18.284 MLS, MLRS	206 kW		06/98→12/05	→09/01; Front; Length 1 [mm]: 600; Quantity: 1	9XW 862 056-001 Wiper Blade	119
25.224 MNLC, MNLLC, MNLRC, MNLLRC, MVLC	162 kW		08/95→12/05			
25.255 MNLC, MNLLC, MNLRC, MNLLRC, MVLC	180 kW		10/00→	→09/01; Front; Length 1 [mm]: 600; Quantity: 1	9XW 862 056-001 Wiper Blade	119
25.264 MNLC, MNLLC, MNLRC, MNLLRC, MVLC	191 kW		08/95→12/05			
25.284 MNLC, MNLLC, MNLRC, MNLLRC, MVLC	206 kW		02/00→	→09/01; Front; Length 1 [mm]: 600; Quantity: 1	9XW 862 056-001 Wiper Blade	119
14.224 MAK	162 kW		08/95→12/05			
14.224 MK	162 kW		08/95→12/05	use plug 81.25435-0134; cap 81.26412-0013; cap 81.96410-0342 as well, according to plug connection (MAN) ; Delivery Quantity [l/h]: 432; Housing Diameter [mm]: 35; elec.; Pressure [bar]: 2.5; Pressure hose connector diameter [mm]: 11; Mono Pump; Quantity: 32; 24 V; Suction pipe connector diameter [mm]: 10.5	8TW 007 540-037 Water Pump, headlight cleaning	110
14.224 MLS, MLRS	162 kW		08/95→12/05			
14.264 MC, MLC, MLLC	191 kW		08/95→12/05	Front; L 500 mm; Quantity: 1	9XW 184 107-201 Wiper Blade	112
14.264 MLS, MLRS	191 kW		08/95→12/05			
14.284 MAK	206 kW		06/98→12/05	Front; L 500 mm; Quantity: 1	9XW 184 107-201 Wiper Blade	112
14.284 MA-KO, MA-LF	206 kW		06/98→12/05			
14.284 MC, MLC, MLLC	206 kW		06/98→12/05	Front; L 600 mm; Quantity: 1	9XW 184 107-241 Wiper Blade	112
14.284 MLS, MLRS	206 kW		06/98→12/05			
14.285 MLC, MLLC (ME280C)	206 kW		09/99→12/05	Front; Length [in]: 24; L 600 mm; Quantity: 1	9XW 191 397-241 Wiper Blade	114
				Front; Length 1 [mm]: 600; Quantity: 1	9XW 862 056-001 Wiper Blade	119
MAN - NG						08/92→
NG 262	191 kW		06/97→07/98	Front; L 900 mm; Quantity: 1	9XW 184 107-361 Wiper Blade	113
NG 262, NG 272	191 - 198 kW		08/92→07/98			
NG 312	228 kW		09/95→07/98			
				Front; Length [in]: 36; L 900 mm; Quantity: 1	9XW 191 397-361 Wiper Blade	116
				Front; Length [in]: 36; L 900 mm; Quantity: 1	9XW 194 562-361 Wiper Blade	117
				Front; Length 1 [mm]: 900; Quantity: 1	9XW 862 061-001 Wiper Blade	119

Manufacturer - Model	Power	Displ.	Year of Constr.	Remark	Part Number	Page
MAN - NG						08/92→
NG 262, NG 263 NG 312, NG 313	191 kW 228 kW		07/98→ 07/98→	elec.; Mono Pump; 24 V; with sensor for wash-water level →11/99; Front; L 900 mm; Quantity: 1 →11/99; Front; Length [in]: 36; L 900 mm; Quantity: 1 →11/99; Front; Length [in]: 36; L 900 mm; Quantity: 1 →11/99; Front; Length 1 [mm]: 900; Quantity: 1	8TW 006 849-091 Water Pump, window cleaning 9XW 184 107-361 Wiper Blade 9XW 191 397-361 Wiper Blade 9XW 194 562-361 Wiper Blade 9XW 862 061-001 Wiper Blade	111 113 116 117 119
MAN - NL						09/89→
NL 202	157 kW		09/89→04/94	→04/93; Front; L 900 mm; Quantity: 1 →04/93; Front; Length [in]: 36; L 900 mm; Quantity: 1 →04/93; Front; Length [in]: 36; L 900 mm; Quantity: 1 →04/93; Front; Length 1 [mm]: 900; Quantity: 1	9XW 184 107-361 Wiper Blade 9XW 191 397-361 Wiper Blade 9XW 194 562-361 Wiper Blade 9XW 862 061-001 Wiper Blade	113 116 117 119
NL 202, NL 222, NL 223	157 - 162 kW		08/92→	elec.; Mono Pump; 24 V; with sensor for wash-water level 07/98→; →09/01; Front; L 800 mm; Quantity: 1 07/98→; →09/01; Front; Length [in]: 32; L 800 mm; Quantity: 1	8TW 006 849-091 Water Pump, window cleaning 9XW 184 107-321 Wiper Blade 9XW 191 397-321 Wiper Blade	111 113 115
NL 202, NL 262, NL 263	184 kW		04/91→	elec.; Mono Pump; 24 V; with sensor for wash-water level Front; L 800 mm; Quantity: 1	8TW 006 849-091 Water Pump, window cleaning 9XW 184 107-321 Wiper Blade	111 113
NL 243	180 kW			09/02→; →09/06; Front; L 800 mm; Quantity: 1 09/02→; →09/06; Front; Length [in]: 32; L 800 mm; Quantity: 1	9XW 184 107-321 Wiper Blade 9XW 191 397-321 Wiper Blade	113 115
NL 262 NL 312	191 kW 228 kW		06/97→ 11/95→07/98	Front; L 800 mm; Quantity: 1	9XW 184 107-321 Wiper Blade	113
NL 262, NL 263	191 kW		07/98→	elec.; Mono Pump; 24 V; with sensor for wash-water level →09/01; Front; L 800 mm; Quantity: 1 →09/01; Front; Length [in]: 32; L 800 mm; Quantity: 1	8TW 006 849-091 Water Pump, window cleaning 9XW 184 107-321 Wiper Blade 9XW 191 397-321 Wiper Blade	111 113 115
NL 313	228 kW		07/98→	elec.; Mono Pump; 24 V; with sensor for wash-water level →12/01; Front; L 800 mm; Quantity: 1 →12/01; Front; Length [in]: 32; L 800 mm; Quantity: 1	8TW 006 849-091 Water Pump, window cleaning 9XW 184 107-321 Wiper Blade 9XW 191 397-321 Wiper Blade	111 113 115
MAN - NM						05/90→03/97
NM 152 NM 152	110 kW 114 kW		05/90→10/93 04/92→03/97	Front; L 800 mm; Quantity: 1	9XW 184 107-321 Wiper Blade	113
MAN - NÜ						09/96→
NÜ 263 NÜ 263 NÜ 313 NÜ 313 15M NÜ 353 15M	191 kW 191 kW 228 kW 228 kW 257 kW		09/96→07/98 07/98→ 07/98→ 07/98→ 07/98→	for headlight cleaning with telescopic jet ; Delivery Quantity [l/h]: 432; elec.; Blade Terminal; Pressure [bar]: 2.5; Pressure hose connector diameter [mm]: 11; Mono Pump; 24 V; Suction pipe connector diameter [mm]: 10.5 elec.; Mono Pump; 24 V; with sensor for wash-water level use plug 81.25435-0134; cap 81.26412-0013; cap 81.96410-0342 as well, according to plug connection (MAN) / for headlight cleaning with telescopic jet ; Delivery Quantity [l/h]: 432; Housing Diameter [mm]: 35; elec.; Pressure [bar]: 2.5; Pressure hose connector diameter [mm]: 11; Mono Pump; Quantity: 32; 24 V; Suction pipe connector diameter [mm]: 10.5	8TW 004 764-041 Water Pump, headlight cleaning 8TW 006 849-091 Water Pump, window cleaning 8TW 007 540-037 Water Pump, headlight cleaning	110 111 110

Manufacturer - Model	Power	Displ.	Year of Constr.	Remark	Part Number	Page
MAN - R					05/85→01/93	
R 292, FR 292, FRH 292	213 - 229 kW		05/85→01/93	Front; L 1,000 mm; Quantity: 1	9XW 184 107-401 Wiper 113 Blade	
				Front; Length [in]: 40; L 1,000 mm; Quantity: 1	9XW 191 397-401 Wiper 116 Blade	
				Front; Length [in]: 40; L 1,000 mm; Quantity: 1	9XW 194 562-401 Wiper 117 Blade	
MAN - SD					04/74→04/94	
SD 200	128 kW		10/75→04/80	Front; L 700 mm; Quantity: 1	9XW 184 107-281 Wiper 112 Blade	
SD 200	129 kW		04/74→09/75	Front; Length [in]: 28; L 700 mm; Quantity: 1	9XW 191 397-281 Wiper 115 Blade	
SD 200	141 kW		04/74→09/75			
SD 200	141 - 147 kW		10/75→11/86			
SD 200	162 kW		06/79→12/86			
SD 202	155 kW		10/85→04/94	04/91→ ; Front; L 800 mm; Quantity: 1	9XW 184 107-321 Wiper 113 Blade	
				04/91→ ; Front; Length [in]: 32; L 800 mm; Quantity: 1	9XW 191 397-321 Wiper 115 Blade	
MAN - SG					07/76→	
SG 220	147 kW		05/80→01/85	Front; L 700 mm; Quantity: 1	9XW 184 107-281 Wiper 112 Blade	
SG 220	162 kW		07/76→04/80	Front; Length [in]: 28; L 700 mm; Quantity: 1	9XW 191 397-281 Wiper 115 Blade	
SG 220,SG 240 HÜ,SG 242 H	177 kW		05/80→01/86			
SG 240 H,SG 292 H	213 kW		11/84→09/89			
SG 240 HÜ	206 kW		09/81→01/86			
SGG 280 H	206 kW		01/82→			
SG 240 H,SG 242,SG 242 H	177 - 180 kW		09/85→04/94	Front; L 800 mm; Quantity: 1	9XW 184 107-321 Wiper 113 Blade	
SG 242,SG 292	224 - 229 kW		09/85→04/94	Front; Length [in]: 32; L 800 mm; Quantity: 1	9XW 191 397-321 Wiper 115 Blade	
SG 312,SG 322	228 - 235 kW		02/94→06/97			
MAN - SL					05/80→04/87	
SL 200	147 - 150 kW		05/80→04/87	Front; L 700 mm; Quantity: 1	9XW 184 107-281 Wiper 112 Blade	
				Front; Length [in]: 28; L 700 mm; Quantity: 1	9XW 191 397-281 Wiper 115 Blade	
SL 200	177 kW		05/80→01/86	→06/84 ; Front; L 700 mm; Quantity: 1	9XW 184 107-281 Wiper 112 Blade	
				→06/84 ; Front; Length [in]: 28; L 700 mm; Quantity: 1	9XW 191 397-281 Wiper 115 Blade	
SL 200	177 kW		01/86→04/87	→04/86 ; Front; L 700 mm; Quantity: 1	9XW 184 107-281 Wiper 112 Blade	
				→04/86 ; Front; Length [in]: 28; L 700 mm; Quantity: 1	9XW 191 397-281 Wiper 115 Blade	
MAN - SL II					06/84→04/94	
SL 202	147 - 155 kW		06/84→04/93	Front; L 800 mm; Quantity: 1	9XW 184 107-321 Wiper 113 Blade	
SL 202	177 - 180 kW		06/84→04/94	Front; Length [in]: 32; L 800 mm; Quantity: 1	9XW 191 397-321 Wiper 115 Blade	
MAN - SR					10/75→11/86	
SR 240	177 kW		10/75→06/83	→07/77 ; Front; L 700 mm; Quantity: 1	9XW 184 107-281 Wiper 112 Blade	
				→07/77 ; Front; Length [in]: 28; L 700 mm; Quantity: 1	9XW 191 397-281 Wiper 115 Blade	
				02/76→ ; Front; Length 1 [mm]: 500; Quantity: 1	9XW 862 052-001 Wiper 118 Blade	
SR 280,SR 280 H	206 kW		01/77→11/86	Front; L 700 mm; Quantity: 1	9XW 184 107-281 Wiper 112 Blade	
SR 321 H	235 kW		03/82→11/86	Front; Length [in]: 28; L 700 mm; Quantity: 1	9XW 191 397-281 Wiper 115 Blade	
				Front; Length 1 [mm]: 500; Quantity: 1	9XW 862 052-001 Wiper 118 Blade	
MAN - SÜ					10/75→06/97	
SÜ 240	147 - 150 kW		05/80→09/89	For split heated windscreen ; →06/84 ; Front; L 700 mm; Quantity: 1	9XW 184 107-281 Wiper 112 Blade	
SÜ 240	206 kW		11/82→01/86	For split heated windscreen ; →06/84 ; Front; L 1,000 mm; Quantity: 1	9XW 184 107-401 Wiper 113 Blade	
				For split heated windscreen ; →06/84 ; Front; Length [in]: 28; L 700 mm; Quantity: 1	9XW 191 397-281 Wiper 115 Blade	
				For split heated windscreen ; →06/84 ; Front; Length [in]: 40; L 1,000 mm; Quantity: 1	9XW 191 397-401 Wiper 116 Blade	
				For split heated windscreen ; →06/84 ; Front; Length [in]: 40; L 1,000 mm; Quantity: 1	9XW 194 562-401 Wiper 117 Blade	

Manufacturer - Model	Power	Displ.	Year of Constr.	Remark	Part Number	Page
MAN - SÜ						10/75→06/97
SÜ 240	177 kW		10/75→01/86	For split heated windscreen ; 10/78-; →06/84; Front; L 700 mm; Quantity: 1	9XW 184 107-281 Wiper 112 Blade	
				For split heated windscreen ; 10/78-; →06/84; Front; L 1,000 mm; Quantity: 1	9XW 184 107-401 Wiper 113 Blade	
				For split heated windscreen ; 10/78-; →06/84; Front; Length [in]: 28; L 700 mm; Quantity: 1	9XW 191 397-281 Wiper 115 Blade	
				For split heated windscreen ; 10/78-; →06/84; Front; Length [in]: 40; L 1,000 mm; Quantity: 1	9XW 191 397-401 Wiper 116 Blade	
				For split heated windscreen ; 10/78-; →06/84; Front; Length [in]: 40; L 1,000 mm; Quantity: 1	9XW 194 562-401 Wiper 117 Blade	
SÜ 240	177 kW		01/86→09/89	Front; L 800 mm; Quantity: 1	9XW 184 107-321 Wiper 113 Blade	
SÜ 240	213 kW		01/86→09/89			
SÜ 272	198 kW		04/93→05/95	Front; L 1,000 mm; Quantity: 1	9XW 184 107-401 Wiper 113 Blade	
SÜ 292	229 kW		04/92→04/93			
SÜ 322	235 kW		05/95→06/97	Front; Length [in]: 40; L 1,000 mm; Quantity: 1	9XW 191 397-401 Wiper 116 Blade	
				Front; Length [in]: 40; L 1,000 mm; Quantity: 1	9XW 194 562-401 Wiper 117 Blade	
MAN - TGA						04/00→
18.310, 18.320 FAC, FHLC	228 - 235 kW		05/04→	Delivery Quantity [l/h]: 432; elec.; Blade Terminal; Pressure [bar]: 2.5; Pressure hose connector diameter [mm]: 11; Mono Pump; 24 V; Suction pipe connector diameter [mm]: 10.5	8TW 004 764-041 Water 110 Pump, headlight cleaning	
18.310, 18.320 FAK, FAK-L, FALK, FALK-L, FHLK, FHLK/M	228 - 235 kW		05/04→			
18.310, 18.320 FAS, FALS, FHLS, FHLS/M	228 - 235 kW		05/04→	elec.; Mono Pump; 24 V; with sensor for wash-water level	8TW 006 849-091 Water 111 Pump, window cleaning	
18.310, 18.320 FC, FLC, FLLC, FLLC/N, FLLW, FLLW/N	228 - 235 kW		05/04→			
18.310, 18.320 FK, FK-L, FLK, FLK/M	228 - 235 kW		05/04→	use plug 81.25435-0134; cap 81.26412-0013; cap 81.96410-0342 as well, according to plug connection (MAN) ; Delivery Quantity [l/h]: 432; Housing Diameter [mm]: 35; elec.; Pressure [bar]: 2.5; Pressure hose connector diameter [mm]: 11; Mono Pump; Quantity: 32; 24 V; Suction pipe connector diameter [mm]: 10.5	8TW 007 540-037 Water 110 Pump, headlight cleaning	
18.310, 18.320 FLS, FLRS, FLLS, FLLRS	228 - 235 kW		05/04→	Front; L 700 mm; Quantity: 1	9XW 184 107-281 Wiper 112 Blade	
18.310, 18320 FC, FLC, FRC, FLLC, FLLC/N, FLLW, FLLRC, FLLRW	228 - 235 kW		04/00→	Front; Length [in]: 28; L 700 mm; Quantity: 1	9XW 191 397-281 Wiper 115 Blade	
18.310, 18320 FK, FLK, FK-L, FLRK	228 - 235 kW		12/00→			
18.310 FLS, FLLS, FLLS/N, FLS- TS, FLRS, FLLRS	228 kW		04/00→			
18.350, 18.360 FAC, FHLC	257 - 265 kW		05/04→			
18.350, 18.360 FAK, FAK-L, FALK, FALK-L, FHLK, FHLK/M	257 - 265 kW		05/04→			
18.350, 18.360 FAS, FALS, FHLS, FHLS/M	257 - 265 kW		05/04→			
18.350, 18.360 FC, FLC, FLLC, FLLRC, FLLC/N, FLLW, FLLW/N	257 - 265 kW		05/04→			
18.350, 18.360 FK, FK-L, FLK, FLK/M,	257 - 265 kW		05/04→			
18.350 FLS, FLS/N, FLS/M, FLS- TS, FLLS, FLLS/N, FLLRS	257 kW		05/04→			
18.360 FC, FLC, FRC, FLLC, FLLC/N, FLLW, FLLRW	265 kW		04/00→			
18.360 FK, FLK, FK-L, FLRK	265 kW		12/00→			
18.360 FLS, FLLS, FLLS/N, FLS- TS, FLRS, FLLRS	265 kW		04/00→			
18.390, 18.400 FAC, FHLC	287 - 294 kW		05/04→			
18.390, 18.400 FAK, FAK-L, FALK, FALK-L, FHLK, FHLK/M	287 - 294 kW		05/04→			
18.390, 18.400 FAS, FALS, FHLS, FHLS/M	287 - 294 kW		05/04→			
18.390, 18.400 FC, FLC, FLLC, FLLC/N, FLLW, FLLW/N	287 - 294 kW		05/04→			
18.390, 18.400 FK, FK-L, FLK, FLK/M	287 - 294 kW		05/04→			
18.390 FLS, FLS-TS, FLS/M, FLLS, FLLS/N, FLLS/M, FLLRS	287 kW		05/04→			
18.410, 18420 FC, FRC, FLC, FLRC, FLLC, FLLC/N, FLLW, FLLRC	301 - 309 kW		04/00→			
18.410, 18420 FK, FK-L, FLK, FLRK	301 - 309 kW		12/00→			
18.410 FLS, FLLS, FLLS/N, FLS- TS, FLRS, FLLRS	301 kW		04/00→			
18.430, 18.440 FAC, FHLC	316 - 324 kW		05/04→			
18.430, 18.440 FAK, FALK, FALK-L, FHLK, FHLK/M	316 - 324 kW		05/04→			
18.430, 18.440 FAS, FALS, FHLS, FHLS/M	316 - 324 kW		05/04→			
18.430, 18.440 FC, FLC, FLLC, FLLW, FLLW/N, FLLRC, FLLRW	316 - 324 kW		05/04→			

Manufacturer - Model	Power	Displ.	Year of Constr.	Remark	Part Number	Page
MAN - TGA						04/00→
18.430, 18.440 FK, FK-L, FLK, FLK/M	316 - 324 kW		05/04→	Delivery Quantity [l/h]: 432; elec.; Blade Terminal; Pressure [bar]: 2.5; Pressure hose connector diameter [mm]: 11; Mono Pump; 24 V; Suction pipe connector diameter [mm]: 10.5	8TW 004 764-041 Water Pump, headlight cleaning	110
18.430 FLS, FLS/M, FLS-TS, FLLS, FLLS/N, FLLRS, FLRS	316 kW		05/04→			
18.460 FAK	338 kW		12/00→	elec.; Mono Pump; 24 V; with sensor for wash-water level	8TW 006 849-091 Water Pump, window cleaning	111
18.460 FC, FLC, FRC, FLLC, FLLC/N, FLLW, FLLRC, FLLRW	338 kW		04/00→			
18.460 FK, FK-L, FLK, FLRK	338 kW		12/00→			
18.460 FLS, FLLS, FLLS/N, FLS-TS, FLRS, FLLRS	338 kW		04/00→			
18.480 FC, FLC, FLLC, FLLW, FLLRW, FLLRC	353 kW		09/02→			
18.480 FK, FLK, FK-L	353 kW		09/02→			
18.480 FLS, FLLS, FLLS/N, FLS-TS, FLRS-WW	353 kW		09/02→	Front; L 700 mm; Quantity: 1	9XW 184 107-281 Wiper Blade	112
18.510 FC, FLC, FRC, FLLC, FLLC/N, FLLW, FLLRC, FLLRW	375 kW		09/00→	Front; Length [in]: 28; L 700 mm; Quantity: 1	9XW 191 397-281 Wiper Blade	115
18.510 FLS, FLLS, FLLS/N, FLRS, FLLRS	375 kW		04/00→			
18.530 FC, FLC, FLLC, FLLC/N, FLLW, FLLRC, FLLRW	390 kW		09/02→			
18.530 FLS, FLLS, FLLS/N	390 kW		09/02→			
24.350, 24.360 FNLLC, FNLLW/N, FNLLRW	257 - 265 kW		05/04→			
24.350, 24.360 FPLS, FPLRS	257 - 265 kW		02/04→			
24.360 FNLLC/N, FNLLW, FNLLRW, FNLLRC	265 kW		09/01→			
24.390, 24.400 FNLLC/N, FNLLW/N, FNLLRC, FNLLRW	287 - 294 kW		05/04→			
24.390, 24.400 FPLS, FPLRS	287 - 294 kW		05/04→			
24.410 FNLLC/N, FNLLW, FNLLRW	301 kW		09/01→			
24.430, 24.440 FNLLC/N, FNLRC, FNLLW	316 - 324 kW		05/04→			
24.430, 24.440 FPLS, FPLRS	316 - 324 kW		05/04→			
24.460 FNLLC/N, FNLLW, FNLLRC, FNLLRW	338 kW		09/01→			
24.480 FNLLC/N, FNLLW, FNLLRC, FNLLRW	353 kW		09/02→			
24.510 FNLLC/N, FNLLW, FNLLRW	375 kW		09/01→			
24.530 FNLLC/N, FNLLW, FNLLRW	390 kW		09/01→			
26.280 FNLC, FNLLC, FNLLW	206 kW		11/02→			
26.310, 26.320 FDC, FDRC, FDC/M, FDRC/M, FDLC, FNHLC, FVHLC	228 - 235 kW		05/04→			
26.310, 26.320 FDK, FDLK	228 - 235 kW		05/04→			
26.310, 26.320 FDS, FDS/M, FDLS, FDRS, FDRS/M, FNHLS, FDLRS	228 - 235 kW		05/04→			
26.310, 26.320 FNLC, FNLLC, FNLRC, FNLLRC, FNLLW	228 - 235 kW		05/04→			
26.310, 26.320 FNLS, FNLLS, FNLRS, FNLLRS	228 - 235 kW		05/04→			
26.310 FDC, FDLC, FDRC, FDLC/M, FDLRC	228 kW		01/01→			
26.310 FDK, FDLK, FDRK	228 kW		09/02→			
26.310 FDS, FDLS, FDLS/M, FDLRS	228 kW		01/01→			
26.310 FD-TM, FDR-TM	228 kW		10/00→			
26.310 FNLC, FNLLC, FVLC, FNLLW, FNLRC, FNLLRW	228 kW		09/00→			
26.310 FPLS, FVLS, FNLS, FNLLS, FPLRS, FNLRS, FVLR	228 kW		12/00→			
26.310 FVL-KO	228 kW		12/00→			
26.330 FNLC, FNLLC, FNLLW	240 kW		11/02→			
26.350, 26.360 FDC, FDRC, FDC/M, FDRC/M, FDLC, FDLRC, FNHLC	257 - 265 kW		05/04→			
26.350, 26.360 FDK, FDLK, FDRK	257 - 265 kW		05/04→			
26.350, 26.360 FDS, FDS/M, FDLS, FDRS, FNHLS, FPHLS	257 - 265 kW		05/04→			
26.350, 26.360 FNLC, FNLLC, FNLLW, FNLRC, FNLLRC	257 - 265 kW		05/04→			
26.350, 26.360 FNLS, FNLLS, FNLRS, FNLLRS, FPLS, FPLRS	257 - 265 kW		05/04→			
26.350 FDLS, FDLRS, FDLRS/M, FDLRS-WW	257 kW		05/04→			

Manufacturer - Model	Power	Displ.	Year of Constr.	Remark	Part Number	Page
MAN - TGA						04/00→
26.360 FDC, FDLC, FDLC/M, FDRC, FDLRC-WW	265 kW		01/01→	Delivery Quantity [l/h]: 432; elec.; Blade Terminal; Pressure [bar]: 2.5; Pressure hose connector diameter [mm]: 11; Mono Pump; 24 V; Suction pipe connector diameter [mm]: 10.5	8TW 004 764-041 Water Pump, headlight cleaning	110
26.360 FDK, FDLK, FDRK, FDLRK	265 kW		09/02→			
26.360 FDLS, FDLRS-WW, FNHLS	265 kW		05/04→	elec.; Mono Pump; 24 V; with sensor for wash-water level	8TW 006 849-091 Water Pump, window cleaning	111
26.360 FDS, FDLS, FNLS, FNLLS, FPLS, FPLRS, FVLS, FVLR	265 kW		12/00→	use plug 81.25435-0134; cap 81.26412-0013; cap 81.96410-0342 as well, according to plug connection (MAN) ; Delivery Quantity [l/h]: 432; Housing Diameter [mm]: 35; elec.; Pressure [bar]: 2.5; Pressure hose connector diameter [mm]: 11; Mono Pump; Quantity: 32; 24 V; Suction pipe connector diameter [mm]: 10.5	8TW 007 540-037 Water Pump, headlight cleaning	110
26.360 FD-TM, FDR-TM	265 kW		01/01→			
26.360 FNLC, FNLLC, FNLLW, FNLLRC, FNLLRW, FVLC	265 kW		09/00→			
26.360 FVL-KO	265 kW		12/00→	Front; L 700 mm; Quantity: 1	9XW 184 107-281 Wiper Blade	112
26.390, 26.400 FDC, FDRC, FDLRC, FDRC/M, FDLC, FNHLC, FVHLC	287 - 294 kW		05/04→			
26.390, 26.400 FDK, FDLK	287 - 294 kW		05/04→			
26.390, 26.400 FDS, FDS/M, FDLS, FDLRS, FNHLS, FPHLS, FVHLS	287 - 294 kW		05/04→			
26.390, 26.400 FNLC, FNLLC, FNLLW, FNLLRC, FNLLRC	287 - 294 kW		05/04→			
26.390, 26.400 FNLS, FNLLS, FNLR, FNLLRS, FPLS, FPLRS	287 - 294 kW		05/04→			
26.390 FDAS, FDALS	287 kW		02/04→			
26.410 FDC, FDLC, FDLC/M, FDLC-WW; FDRC-WW, FDLRC-WW	301 kW		01/01→			
26.410 FDK, FDRK, FDLK, FDLRK	301 kW		09/01→			
26.410 FDS, FDLS, FDLS/M, FDLS-WW, FDRS-WW, FDLRS-WW	301 kW		06/01→			
26.410 FD-TM, FDR-TM	301 kW		01/01→			
26.410 FNLC, FNLLC, FNLLW, FNLR, FNLLRC, FVLC	301 kW		04/00→			
26.410 FPLS, FPLRS, FVLS, FNLS, FNLLS	301 kW		12/00→			
26.410 FVL-KO	301 kW		12/00→			
26.430, 26.440, FNLC, FNLLC, FNLLW, FNLR, FNLLRC, FVLC	316 - 324 kW		05/04→			
26.430, 26.440, FNLS, FNLLS, FNLR, FNLLRS, FPLS, FPLRS	316 - 324 kW		05/04→			
26.430, 26.440 FDC, FDRC, FDLC, FDLRC, FDLC/M, FNHLC, FVHLC	316 - 324 kW		05/04→			
26.430, 26.440 FDK, FDLK	316 - 324 kW		05/04→			
26.460 FDC, FDLC, FDLC/M, FDLC-WW, FDRC, FDLRC-WW	338 kW		01/01→			
26.460 FDK, FDLK, FDLRK	338 kW		01/01→			
26.460 FDS, FDLS, FDLS/M, FDLS-WW, FDRS-WW, FDLRS-WW	338 kW		06/01→			
26.460 FD-TM, FDR-TM	338 kW		01/01→			
26.460 FNLC, FNLR, FNLLC, FNLLRW, FNLLRC	338 kW		04/00→			
26.460 FPLS, FPLRS, FVLS, FVLR, FNLS, FNLLS, FNLR	338 kW		12/00→			
26.460 FVLC	338 kW		02/01→			
26.460 FVL-KO	338 kW		12/00→			
26.480 FDC, FDC/M, FDLC, FDLRC, FDRC, FNHLC, FVHLC, FDLRC-WW	353 kW		02/06→			
26.480 FDC, FDLC, FDRC, FDLC/M, FDLRC-WW	353 kW		09/02→			
26.480 FDK, FDLK	353 kW		02/06→			
26.480 FDK, FDLK, FDLRK	353 kW		09/02→			
26.480 FDS, FDLS, FDLRS, FNHLS, FPHLS, FVHLS	353 kW		02/06→			
26.480 FDS, FDLS, FDLS/M, FDLRS-WW, FDRS	353 kW		09/02→			
26.480 FD-TM	353 kW		09/02→			
26.480 FNLC, FNLLC, FVLC, FNLLRC, FVLLW	353 kW		09/02→			
26.480 FNLC, FNLR, FNLLC, FNLLW, FVLC, FNLLRC, FNLLW, FVLC	353 kW		02/06→			
26.480 FNLS, FNLLS, FNLR, FPLS, FVLS	353 kW		09/02→			
26.480 FNLS, FNLLS, FNLR, FPLS, FVLS, FVLR	353 kW		02/06→			
26.480 FVL-KO	353 kW		09/02→			

Manufacturer - Model	Power	Displ.	Year of Constr.	Remark	Part Number	Page
MAN - TGA						04/00→
26.510 FDC, FDC/M, FDRC, FDLC, FDLC/M, FDLRC	375 kW		01/01→	Delivery Quantity [l/h]: 432; elec.; Blade Terminal; Pressure [bar]: 2.5; Pressure hose connector diameter [mm]: 11; Mono Pump; 24 V; Suction pipe connector diameter [mm]: 10.5	8TW 004 764-041 Water Pump, headlight cleaning	110
26.510 FDS, FDLS, FDLS/M, FDRS, FDLRS	375 kW		01/01→			
26.510 FNLC, FNLLC, FNLLW, FNLLRC, FVLC	375 kW		12/00→	elec.; Mono Pump; 24 V; with sensor for wash-water level	8TW 006 849-091 Water Pump, window cleaning	111
26.510 FNLS, FNLLS, FNLRs, FPLS, FVLS	375 kW		12/00→	use plug 81.25435-0134; cap 81.26412-0013; cap 81.96410-0342 as well, according to plug connection (MAN) ; Delivery Quantity [l/h]: 432; Housing Diameter [mm]: 35; elec.; Pressure [bar]: 2.5; Pressure hose connector diameter [mm]: 11; Mono Pump; Quantity: 32; 24 V; Suction pipe connector diameter [mm]: 10.5	8TW 007 540-037 Water Pump, headlight cleaning	110
26.530 FDC, FDLC, FDC/M, FDLRC	390 kW		01/01→			
26.530 FDK, FDLK, FDLRK	390 kW		09/02→			
26.530 FDS, FDLS, FDLS/M, FDLRS	390 kW		01/01→			
26.530 FNLC, FNLLC, FNLLW, FNLLRC, FVLC, FVLC	390 kW		09/02→	Front; L 700 mm; Quantity: 1	9XW 184 107-281 Blade	112
26.530 FNLS, FNLLS, FNLRs, FPLS, FVLS, FVLRs	390 kW		09/02→	Front; Length [in]: 28; L 700 mm; Quantity: 1	9XW 191 397-281 Blade	115
28.430 FNLS, FNLRs-WW	316 kW		05/04→			
32.310 FFDC, FFDLC, FFDLRC	228 kW		01/02→			
32.310 FFDK, FFDLK	228 kW		01/02→			
32.310 FFD-TM	228 kW		01/02→			
32.360 FFDC, FFDLC, FFDLRC	265 kW		01/02→			
32.360 FFDK, FFDLK	265 kW		01/02→			
32.360 FFD-TM	265 kW		01/02→			
32.410 FFDC, FFDLC, FFDRC, FFDLRC	301 kW		01/02→			
32.410 FFDK, FFDLK	301 kW		01/02→			
32.410 FFD-TM	301 kW		01/02→			
32.460 FFDC, FFDLC, FFDLRC	338 kW		01/02→			
32.460 FFDK, FFDLK	338 kW		01/02→			
32.460 FFD-TM	338 kW		01/02→			
32.480 FFDC, FFDLC, FFDLRC	353 kW		09/02→			
32.480 FFDK, FFDLK	353 kW		09/02→			
32.480 FFD-TM	353 kW		09/02→			
33.360 FDC, FDC-WW, FDLC/M, FDRC-WW, FDLRC	265 kW		10/00→			
33.360 FDK, FDK-WW, FDLK, FDRK-WW	265 kW		01/01→			
33.360 FDS, FDS-WW, FDLS, FDLRS, FDRS-WW	265 kW		10/00→			
33.360 FD-TM, FDR-TM	265 kW		01/01→			
33.410 FDC, FDC-WW, FDLC, FDLRC, FDRC-WW	301 kW		10/00→			
33.410 FDK, FDK-WW, FDLK, FDRK-WW	301 kW		10/00→			
33.410 FDS, FDS-WW, FDLS, FDLS/M, FDLRS, FDRS-WW	301 kW		10/00→			
33.410 FD-TM, FDR-TM	301 kW		10/00→			
33.460 FDC, FDC-WW, FDLC, FDLRC, FDRC-WW	338 kW		09/02→			
33.460 FDK, FDK-WW, FDLK, FDRK-WW	338 kW		09/02→			
33.460 FDS, FDLS, FDLS/M, FDLRS, FDRS-WW	338 kW		09/02→			
33.460 FD-TM, FDR-TM	338 kW		09/02→			
33.480 FDC, FDC-WW, FDLC, FDRC-WW, FDLRC	353 kW		09/02→			
33.480 FDK, FDK-WW, FDLK, FDRK-WW	353 kW		09/02→			
33.480 FDS, FDS-WW, FDLS, FDLS/M, FDRS-WW, FDLRS	353 kW		09/02→			
33.480 FD-TM	353 kW		09/02→			
33.510 FDC, FDC/M, FDLC, FDRC, FDLRC	375 kW		09/02→			
33.510 FDS, FDLS/M, FDRS, FDLRS/M	375 kW		09/02→			
33.530 FDC, FDC/M, FDLC, FDRC, FDLRC	390 kW		09/02→			
35.310 FFDC, FFDLC	228 kW		06/03→			
35.310 FFDK, FFDLK	228 kW		06/03→			
35.360 FFDC, FFDLC	265 kW		10/03→			
35.360 FFDK, FFDLK	265 kW		10/03→			
35.410 FFDC, FFDLC	301 kW		10/03→			
35.410 FFDK, FFDLK	301 kW		10/03→			
35.460 FFDC, FFDLC	338 kW		10/03→			
35.460 FFDK, FFDLK	338 kW		10/03→			
35.480 FFDC, FFDLC	353 kW		10/03→			
35.480 FFDK, FFDLK	353 kW		10/03→			
35.530 FFDC, FFDLC	390 kW		04/04→			
40.410 FDK-WW	301 kW		04/04→			
40.410 FDS-WW	301 kW		04/04→			

Manufacturer - Model	Power	Displ.	Year of Constr.	Remark	Part Number	Page
MAN - TGA						04/00→
40.440 FDK-WW, FDRK	324 kW		06/05→	Delivery Quantity [l/h]: 432; elec.; Blade Terminal; Pressure [bar]: 2.5; Pressure hose connector diameter [mm]: 11; Mono Pump; 24 V; Suction pipe connector diameter [mm]: 10.5	8TW 004 764-041 Water Pump, headlight cleaning	110
40.440 FDS-WW, FDRS	324 kW		06/05→			
40.460 FDK-WW	338 kW		04/04→			
40.460 FDS-WW	338 kW		04/04→			
40.480 FDK-WW	353 kW		04/04→			
40.480 FDK-WW, FDRK	353 kW		06/05→			
40.480 FDS-WW	353 kW		04/04→			
40.480 FDS-WW; FDRS	353 kW		06/05→			
41.360 FFDC, FFDC/M, FFDC/M-WW, FFDRC	265 kW		01/03→			
						elec.; Mono Pump; 24 V; with sensor for wash-water level
				use plug 81.25435-0134; cap 81.26412-0013; cap 81.96410-0342 as well, according to plug connection (MAN) ; Delivery Quantity [l/h]: 432; Housing Diameter [mm]: 35; elec.; Pressure [bar]: 2.5; Pressure hose connector diameter [mm]: 11; Mono Pump; Quantity: 32; 24 V; Suction pipe connector diameter [mm]: 10.5	8TW 007 540-037 Water Pump, headlight cleaning	110
				Front; L 700 mm; Quantity: 1	9XW 184 107-281 Wiper Blade	112
				Front; Length [in]: 28; L 700 mm; Quantity: 1	9XW 191 397-281 Wiper Blade	115
18.310 FAC, FARC	228 kW		09/02→	Delivery Quantity [l/h]: 432; elec.; Blade Terminal; Pressure [bar]: 2.5; Pressure hose connector diameter [mm]: 11; Mono Pump; 24 V; Suction pipe connector diameter [mm]: 10.5	8TW 004 764-041 Water Pump, headlight cleaning	110
18.310 FAK, FAK-L, FALK	228 kW		09/02→			
18.310 FAS, FARS	228 kW		09/02→			
18.360 FAC, FARC	265 kW		09/02→			
18.360 FAK, FALK, FAK-L, FALK-L	265 kW		09/02→			
18.360 FAS, FALS, FARS	265 kW		09/02→			
18.410, 18420 FAK, FAK-L, FALK	301 - 309 kW		09/02→			
18.410 FAC, FARC	301 kW		09/02→			
18.410 FAS, FALS, FARS	301 kW		09/02→			
18.480 FAC, FARC	353 kW		09/02→			
18.480 FAK, FAK-L, FALK	353 kW		09/02→			
18.480 FAS, FALS, FARS	353 kW		09/02→			
19.350 FS, FRS, FLS, FLRS-WW	257 kW		05/04→	use plug 81.25435-0134; cap 81.26412-0013; cap 81.96410-0342 as well, according to plug connection (MAN) ; Delivery Quantity [l/h]: 432; Housing Diameter [mm]: 35; elec.; Pressure [bar]: 2.5; Pressure hose connector diameter [mm]: 11; Mono Pump; Quantity: 32; 24 V; Suction pipe connector diameter [mm]: 10.5	8TW 007 540-037 Water Pump, headlight cleaning	110
19.360 FS, FRS, FLS, FLRS-WW	265 kW		05/04→			
19.390 FS, FRS, FLS, FLRS-WW	287 kW		05/04→			
19.400 FS/M-WW, FRS/M-WW, FLS, FLRS	294 kW		05/04→			
19.430 FS/M-WW, FLS, FRS, FLRS	316 kW		05/04→			
19.440 FRS, FS/M-WW, FLS, FLRS	324 kW		02/06→			
19.480 FLS, FRS, FLRS-WW	353 kW		02/06→			
19.480 FS/M, FRS/M-WW	353 kW		02/06→			
26.310 FDAC, FDARC	228 kW		02/02→			
26.310 FDAK	228 kW		02/02→			
26.310 FDAS, FDARS	228 kW		02/02→			
26.350 FDLRC-WW	257 kW		05/04→			
26.360 FDAC, FDARC	265 kW		02/02→			
26.360 FDAK, FDALK	265 kW		02/02→			
26.360 FDAS, FDARS	265 kW		02/02→			
26.360 FDLC-WW, FDLRC	265 kW		05/04→			
26.410 FDAC, FDARC	301 kW		02/02→			
26.410 FDAK, FDALK	301 kW		02/02→			
26.410 FDAS, FDALS, FDARS	301 kW		02/02→			
26.430 FDLS, FDLS/M, FDLRS-WW	316 - 324 kW		02/04→			
26.440 FDLC-WW, FDLRC-WW	324 kW		02/06→			
26.440 FDS, FDLS, FDLS-WW, FDLRS-WW	324 kW		02/06→			
26.480 FDAC, FDALC, FDARC	353 kW		09/02→			
26.480 FDAK, FDALK	353 kW		09/02→			
26.480 FDAS, FDALS, FDARS	353 kW		09/02→			
28.310 FNLC, FNLLC	228 kW		09/02→			
28.310 FNLC, FNLLC, FNLRC	228 kW		09/02→			
28.310 FNLS, FNLRS	228 kW		09/02→			
28.350 FNLS, FNLRS-WW	257 kW		02/04→			
28.360 FNLC, FNLLC	265 kW		09/02→			
28.360 FNLS, FNLRS	265 kW		09/02→			
28.390 FNLS, FNLRS	287 kW		05/04→			
28.410 FNLC, FNLLC	301 kW		09/02→			
28.410 FNLC, FNLLC, FNLRC	301 kW		09/02→			
28.410 FNLS, FNLRS	301 kW		09/02→			
28.460 FNLC, FNLLC, FNLRC	338 kW		09/02→			
28.460 FNLS, FNLRS	338 kW		09/02→			
28.480 FNLC, FNLLC, FNLRC	353 kW		09/02→			
28.480 FNLC, FNLRC-WW, FNLLC	353 kW		02/06→			
28.480 FNLS, FNLRS	353 kW		09/02→			
28.480 FNLS, FNLRS-WW	353 kW		02/06→			
28.510 FNLC, FNLLC, FNLRC	375 kW		09/02→			
28.510 FNLS, FNLRS	375 kW		09/02→			
28.530 FNLC, FNLLC, FNLRC	390 kW		09/02→			
28.530 FNLS, FNLRS	390 kW		09/02→			

Manufacturer - Model	Power	Displ.	Year of Constr.	Remark	Part Number	Page
MAN - TGA						04/00→
33.360 FDAC, FDARC, FDAC-WW	265 kW		09/02→	Delivery Quantity [l/h]: 432; elec.; Blade Terminal; Pressure [bar]: 2.5; Pressure hose connector diameter [mm]: 11; Mono Pump; 24 V; Suction pipe connector diameter [mm]: 10.5	8TW 004 764-041	Water 110 Pump, headlight cleaning
33.360 FDAK, FDAK-WW	265 kW		09/02→			
33.360 FDAS, FDAS-WW	265 kW		09/02→			
33.410 FDAC, FDAC-WW, FDALC	301 kW		09/02→	use plug 81.25435-0134; cap 81.26412-0013; cap 81.96410-0342 as well, according to plug connection (MAN) ; Delivery Quantity [l/h]: 432; Housing Diameter [mm]: 35; elec.; Pressure [bar]: 2.5; Pressure hose connector diameter [mm]: 11; Mono Pump; Quantity: 32; 24 V; Suction pipe connector diameter [mm]: 10.5	8TW 007 540-037	Water 110 Pump, headlight cleaning
33.410 FDAK, FDAK-WW, FDALK	301 kW		09/02→			
33.410 FDAS, FDAS-WW, FDALS	301 kW		09/02→			
33.440 FDAC, FDHC	324 kW		06/05→	Front; L 700 mm; Quantity: 1	9XW 184 107-281	Wiper 112 Blade
33.440 FDAK, FDHK	324 kW		06/05→			
33.440 FDAS, FDHS	324 kW		06/05→			
33.440 FDC, FDRC	324 kW		06/05→	Front; Length [in]: 28; L 700 mm; Quantity: 1	9XW 191 397-281	Wiper 115 Blade
33.440 FDK, FDRK	324 kW		06/05→			
33.440 FDS, FDRS	324 kW		06/05→			
33.480 FDAC, FDAC-WW, FDALC, FDARC	353 kW		09/02→			
33.480 FDAK, FDAK-WW, FDALK	353 kW		09/02→			
33.480 FDAS, FDAS-WW, FDARS, FDALS	353 kW		09/02→			
33.530 FDAC, FDALC	390 kW		09/02→			
33.530 FDAK, FDALK	390 kW		09/02→			
33.530 FDAS, FDALS	390 kW		09/02→			
35.390 FFDAK	287 kW		02/04→			
35.530 FFDK, FFDLK	390 kW		04/04→			
40.440 FDAK-WW	324 kW		06/05→			
40.440 FDAS-WW	324 kW		06/05→			
41.390 FFDAK	287 kW		12/04→			
41.430 FFDAK	316 kW		12/04→			
41.440 FFD/M	324 kW		12/04→			
41.440 FFDC, FFDRC	324 kW		12/04→			
41.440 FFDK, FFDK	324 kW		12/04→			
41.480 FFDAK	353 kW		07/06→			
41.530 FVDS, FVDLS	390 kW		09/02→			
41.660 FVDS, FVDLS	485 kW		09/02→			
18.360 FLS, FLLS, FLRS, FLLRS	265 kW		01/06→	elec.; Mono Pump; 24 V; with sensor for wash-water level	8TW 006 849-091	Water 111 Pump, window cleaning
18.400 FLS, FLLS, FLRS, FLLRS	294 kW		10/05→			
18.440 FLS, FLLS, FLRS, FLLRS	324 kW		09/05→	Front; L 700 mm; Quantity: 1	9XW 184 107-281	Wiper 112 Blade
18.480 FC, FLC, FLLC, FLLRC, FLLW, FLRC	353 kW		01/06→			
18.480 FHLC	353 kW		04/06→	Front; Length [in]: 28; L 700 mm; Quantity: 1	9XW 191 397-281	Wiper 115 Blade
18.480 FHLK, FHLK/M	353 kW		04/06→			
18.480 FHLS, FHLS/M	353 kW		04/06→			
18.480 FK, FK-L, FLK	353 kW		01/06→			
18.480 FLS, FLLS, FLRS, FLLRS	353 kW		01/06→			
18.540 FLC, FLRC, FLLC, FLLRC, FLLW	397 kW		08/06→			
18.540 FLS, FLRS, FLLS, FLLRS	397 kW		08/06→			
19.360 FS/M-WW, FRS/M-WW	265 kW		05/04→			
19.410 FS/M-WW, FRS/M-WW	301 kW		05/04→			
19.460 FS/M-WW, FRS/M-WW	338 kW		05/04→			
19.480 FS/M-WW, FRS/M-WW	353 kW		05/04→			
24.480 FNLLC/N, FNLLW/N	353 kW		01/06→			
24.480 FPLS, FPLRS	353 kW		07/05→			
24.480 FPLS, FPLRS	353 kW		01/06→			
24.530 FPLS, FPLRS	390 kW		07/05→			
24.540 FNLLC/N, FLLCW/N	397 kW		01/06→			
26.310, 26.320 FDH, FDHC, FDHC/M	228 - 235 kW		06/05→			
26.310, 26.320 FDHK	228 - 235 kW		06/05→			
26.310, 26.320 FDHS, FDHS/M	228 - 235 kW		06/05→			
26.310, 26.320 FDH-TM	228 - 235 kW		06/05→			
26.310, 26.320 FD-TM	228 - 235 kW		06/05→			
26.310, 26.320 FVHL-KO	228 - 235 kW		06/05→			
26.310, 26.320 FVLC	228 - 235 kW		02/04→			
26.310, 26.320 FVL-KO	228 - 235 kW		02/04→			
26.310 FVLC	228 kW		09/03→			
26.350, 26.360 FDHK, FDHLK	257 - 265 kW		05/04→			
26.350, 26.360 FDHS, FDHS/M, FDHLS	257 - 265 kW		05/04→			
26.350, 26.360 FDH-TM	257 - 265 kW		05/04→			
26.350, 26.360 FD-TM	257 - 265 kW		02/04→			
26.350, 26.360 FVHL-KO	257 - 265 kW		06/05→			
26.350, 26.360 FVL-KO	257 - 265 kW		01/04→			
26.350 FDHC, FDHC/M	257 kW		04/05→			
26.350 FVHLC	257 kW		06/05→			
26.350 FVHLS	257 kW		07/05→			
26.350 FVLC	257 kW		01/04→			
26.350 FVLS, FVLR	257 kW		07/05→			

Manufacturer - Model	Power	Displ.	Year of Constr.	Remark	Part Number	Page
MAN - TGA						04/00→
26.360 FDHC, FDHLC	265 kW		05/04→	elec.; Mono Pump; 24 V; with sensor for wash-water level	8TW 006 849-091 Water Pump, window cleaning	111
26.360 FDLS, FDLS/M, FDLRS, FDLRS/M, FDLRS-WW, FDRS	265 kW		09/03→			
26.360 FVHLC	265 kW		04/06→	Front; L 700 mm; Quantity: 1	9XW 184 107-281 Wiper Blade	112
26.360 FVHLS	265 kW		04/06→	Front; Length [in]: 28; L 700 mm; Quantity: 1	9XW 191 397-281 Wiper Blade	115
26.360 FVLC	265 kW		04/06→			
26.360 FVLS, FVLRS	265 kW		04/06→			
26.390, 26.400 FDHC, FDHC/M, FDHLC	287 - 294 kW		06/05→			
26.390, 26.400 FDHK, FDHLK	287 - 294 kW		06/05→			
26.390, 26.400 FDHS, FDHS/M, FDHLS	287 - 294 kW		06/05→			
26.390, 26.400 FD-TM	287 - 294 kW		05/04→			
26.390, 26.400 FVHL-KO	287 - 294 kW		06/05→			
26.390, 26.400 FVL-KO	287 - 294 kW		02/04→			
26.390 FDH-TM	287 kW		06/05→			
26.390 FVLC	287 kW		02/04→			
26.390 FVLS, FVLRS	287 kW		07/05→			
26.400 FDH-TM	294 kW		04/06→			
26.400 FVLC	294 kW		04/06→			
26.400 FVLS, FVLRS	294 kW		04/06→			
26.410 FVLC	301 kW		09/03→			
26.410 FVLS, FVLRS	301 kW		07/05→			
26.430, 26.440 FDHC, FDHC/M, FDHLC	316 - 324 kW		06/05→			
26.430, 26.440 FDHK, FDHLK	316 - 324 kW		06/05→			
26.430, 26.440 FDHS, FDHS/M, FDHLS	316 - 324 kW		06/05→			
26.430, 26.440 FDH-TM	316 - 324 kW		06/05→			
26.430, 26.440 FDS, FDLS, FDRS, FDLRS, FNHLS, FPHLS, FVHLS	316 - 324 kW		02/04→			
26.430, 26.440 FD-TM	316 - 324 kW		05/04→			
26.430, 26.440 FVLH-KO	316 - 324 kW		06/05→			
26.430 FVL-KO	316 kW		12/00→			
26.430 FVLS, FVLRS	316 kW		07/05→			
26.440 FVL-KO	324 kW		09/05→			
26.440 FVLS, FVLRS	324 kW		09/05→			
26.480 FDHC, FDHC/M, FDHLC	353 kW		02/06→			
26.480 FDHK, FDHLK	353 kW		02/06→			
26.480 FDHS, FDHS/M, FDHLS	353 kW		02/06→			
26.480 FDH-TM	353 kW		02/06→			
26.480 FD-TM	353 kW		02/06→			
26.540 FNLC, FNLLC, FNLLRC, FNLLW	397 kW		08/06→			
33.350, 33.360 FDAC, FDHC, FDHC/M	257 - 265 kW		06/05→			
33.350, 33.360 FDAK, FDHK	257 - 265 kW		06/05→			
33.350, 33.360 FDAS, FDHS, FDHS/M	257 - 265 kW		06/05→			
33.350, 33.360 FDC, FDC/M, FDLC, FDRC	257 - 265 kW		05/04→			
33.350, 33.360 FDK, FDLK, FDRK	257 - 265 kW		05/04→			
33.350, 33.360 FDS, FDLS, FDS/M, FDRS	257 - 265 kW		05/04→			
33.390, 33.400 FDAC, FDHC, FDHC/M	287 - 295 kW		06/05→			
33.390, 33.400 FDAK, FDHK	287 - 295 kW		06/05→			
33.390, 33.400 FDAS, FDHS, FDHS/M	287 - 295 kW		06/05→			
33.390, 33.400 FDC, FDLC, FDRC, FDC/M	287 - 294 kW		05/04→			
33.390, 33.400 FDK, FDLK, FDRK	287 - 294 kW		05/04→			
33.390, 33.400 FDS, FDLS, FDLRS, FDRS, FDS/M	287 - 294 kW		05/04→			
33.430, 33.440 FDAC, FDALC, FDHC, FDHC/M	316 - 324 kW		06/05→			
33.430, 33.440 FDC, FDLC, FDRC, FDLRC, FDC/M	316 - 324 kW		05/04→			
33.430, 33.440 FDK, FDLK, FDRK	316 - 324 kW		05/04→			
33.430, 33.440 FDS, FDLS, FDRS, FDLRS, FDS/M	316 - 324 kW		05/04→			
33.480 FDC, FDLC, FDRC, FDC/M	353 kW		01/06→			
33.480 FDK, FDLK, FDRK	353 kW		01/06→			
33.530 FDK, FDLK	390 kW		07/03→			
35.310, 35.320 FFDC, FFDLC	228 - 235 kW		02/04→			
35.310, 35.320 FFDK, FFDLK	228 - 235 kW		02/04→			

Manufacturer - Model	Power	Displ.	Year of Constr.	Remark	Part Number	Page
MAN - TGA						04/00→
35.310, 35.320 FFD-TM	228 - 235 kW		02/04→	elec.; Mono Pump; 24 V; with sensor for wash-water level	8TW 006 849-091 Water Pump, window cleaning	111
35.310 FFD-TM	228 kW		11/03→			
35.350, 35.360 FFDC, FFDRK, FFDLC	257 - 265 kW		02/04→	Front; L 700 mm; Quantity: 1	9XW 184 107-281 Wiper Blade	112
35.350, 35.360 FFDK, FFDRK, FFDLK	257 - 265 kW		02/04→	Front; Length [in]: 28; L 700 mm; Quantity: 1	9XW 191 397-281 Wiper Blade	115
35.350, 35.360 FFD-TM	257 - 265 kW		02/04→			
35.360 FFD-TM	265 kW		11/03→			
35.390, 35.400 FFDC, FFDRK, FFDLC	287 - 294 kW		02/04→			
35.390, 35.400 FFDK, FFDRK, FFDLK	287 - 294 kW		02/04→			
35.390, 35.400 FFD-TM	287 - 294 kW		02/04→			
35.410 FFD-TM	301 kW		11/03→			
35.430, 35.440 FFDC, FFDRK, FFDLC	316 - 324 kW		02/04→			
35.430, 35.440 FFDK, FFDRK, FFDLK	316 - 324 kW		02/04→			
35.430, 35.440 FFD-TM	316 - 324 kW		02/04→			
35.460 FFD-TM	338 kW		11/03→			
35.480 FFDC, FFDLC	353 kW		02/04→			
35.480 FFDK, FFDLK	353 kW		02/04→			
35.480 FFD-TM	353 kW		11/03→			
35.480 FFD-TM	353 kW		02/04→			
35.530 FFD-TM	390 kW		04/04→			
37.310, 37.320 FFDC	228 - 235 kW		12/04→			
37.310, 37.320 FFDK	228 - 235 kW		12/04→			
37.310, 37.320 FFD-TM	228 - 235 kW		12/04→			
37.310 FFDC	228 kW		12/04→			
37.310 FFDK	228 kW		12/04→			
37.310 FFD-TM	228 kW		12/04→			
37.350, 37.360 FFDC	257 - 265 kW		12/04→			
37.350, 37.360 FFDK	257 - 265 kW		12/04→			
37.350, 37.360 FFD-TM	257 - 265 kW		12/04→			
37.360 FFDC	265 kW		12/04→			
37.360 FFDK	265 kW		12/04→			
37.360 FFD-TM	265 kW		12/04→			
37.390, 37.400 FFDC	287 - 294 kW		12/04→			
37.390, 37.400 FFDK	287 - 294 kW		12/04→			
37.390, 37.400 FFD-TM	287 - 294 kW		12/04→			
37.410 FFDC	301 kW		12/04→			
37.410 FFDK	301 kW		12/04→			
37.410 FFD-TM	301 kW		12/04→			
37.430, 37.440 FFDC	316 - 324 kW		12/04→			
37.430, 37.440 FFDK	316 - 324 kW		12/04→			
37.430, 37.440 FFD-TM	316 - 324 kW		12/04→			
37.460 FFDC	338 kW		12/04→			
37.460 FFDK	338 kW		12/04→			
37.460 FFD-TM	338 kW		12/04→			
37.480 FFDC	353 kW		12/04→			
37.480 FFDC	353 kW		02/06→			
37.480 FFDK	353 kW		12/04→			
37.480 FFDK	353 kW		02/06→			
37.480 FFD-TM	353 kW		12/04→			
37.480 FFD-TM	353 kW		02/06→			
37.530 FFDC	390 kW		12/04→			
37.530 FFDK	390 kW		12/04→			
37.530 FFD-TM	390 kW		12/04→			
40.390, 40.400 FDK-WW, FDRK	287 - 294 kW		06/05→			
40.390, 40.400 FDS-WW, FDRS	287 - 294 kW		06/05→			
40.430 FDK-WW, FDRK	316 kW		06/05→			
40.430 FDS-WW, FDRS	316 kW		06/05→			
41.350, 41.360 FFDC, FFDC/M, FFDRK	257 - 265 kW		12/04→			
41.350, 41.360 FFDK, FFDRK	257 - 265 kW		12/04→			
41.350, 41.360 FFD-TM	257 - 265 kW		12/04→			
41.360 FFDC-WW	265 kW		09/03→			
41.360 FFD-TM	265 kW		12/04→			
41.390, 41.400 FFDC, FFDRK, FFDC/M	287 - 294 kW		12/04→			
41.390, 41.400 FFDK, FFDRK	287 - 294 kW		12/04→			
41.390, 41.400 FFD-TM	287 - 294 kW		12/04→			
41.410 FFDC-WW, FDRK	301 kW		09/03→			
41.410 FFDC-WW	301 kW		09/03→			
41.410 FFD-TM	301 kW		12/04→			
41.430, 41.440 FFDC, FFDRK, FFDC/M	316 - 324 kW		12/04→			
41.430, 41.440 FFDK, FFDRK	316 - 324 kW		12/04→			
41.430, 41.440 FFD-TM	316 - 324 kW		12/04→			
41.460 FFDC-WW, FFDRK	338 kW		09/03→			
41.460 FFDC-WW	338 kW		09/03→			

Manufacturer - Model	Power	Displ.	Year of Constr.	Remark	Part Number	Page
MAN - TGA						04/00→
41.460 FFD-TM	338 kW		12/04→	elec.; Mono Pump; 24 V; with sensor for wash-water level	8TW 006 849-091 Water Pump, window cleaning	111
41.480 FFDC, FFDRC, FFDRC/M	353 kW		02/06→			
41.480 FFDC-WW, FFDRC	353 kW		06/05→	Front; L 700 mm; Quantity: 1	9XW 184 107-281 Wiper Blade	112
41.480 FFDK, FFDRC	353 kW		02/06→			
41.480 FFDK-WW	353 kW		06/05→	Front; Length [in]: 28; L 700 mm; Quantity: 1	9XW 191 397-281 Wiper Blade	115
41.480 FFD-TM	353 kW		12/04→			
41.530 FFDC	390 kW		12/04→			
41.530 FFDK	390 kW		12/04→			
18.480 FAC	353 kW		02/06→	Front; L 700 mm; Quantity: 1	9XW 184 107-281 Wiper Blade	112
18.480 FAK, FALK	353 kW		02/06→			
18.480 FAS, FALS	353 kW		02/06→	Front; Length [in]: 28; L 700 mm; Quantity: 1	9XW 191 397-281 Wiper Blade	115
18.530 FAC	390 kW		04/04→			
18.530 FAK, FALK	390 kW		04/04→			
18.530 FAS, FALS	390 kW		04/04→			
26.310 FDAC	228 kW		01/04→			
26.310 FDAK	228 kW		01/04→			
26.310 FDAS	228 kW		01/04→			
26.320 FDAC	235 kW		04/06→			
26.320 FDAK	235 kW		04/06→			
26.320 FDAS	235 kW		04/06→			
26.350 FDAC	257 kW		02/04→			
26.350 FDAK	257 kW		02/04→			
26.350 FDAS	257 kW		02/04→			
26.360 FDAC, FDARC	265 kW		06/04→			
26.360 FDAK, FDARK	265 kW		06/04→			
26.360 FDAS, FDARS	265 kW		06/04→			
26.390 FDAC, FDALC	287 kW		01/04→			
26.390 FDAK, FDALK	287 kW		02/04→			
26.400 FDAC, FDALC	294 kW		01/04→			
26.400 FDAK, FDALK	294 kW		01/04→			
26.400 FDAS, FDALS	294 kW		01/04→			
26.430 FDAC, FDALC	316 kW		01/04→			
26.430 FDAK, FDALK	316 kW		01/04→			
26.430 FDAS, FDALS	316 kW		01/04→			
26.440 FDAC, FDALC	324 kW		09/05→			
26.440 FDAK, FDALK	324 kW		01/04→			
26.440 FDAS, FDALS	324 kW		01/04→			
26.480 FDAC, FDALC	353 kW		02/06→			
26.480 FDAK, FDALK	353 kW		02/06→			
26.480 FDAS, FDALS	353 kW		02/06→			
26.480 FVHL-KO	353 kW		02/06→			
26.480 FVL-KO	353 kW		01/06→			
26.530 FDAC, FDALC	390 kW		07/06→			
26.530 FDAK, FDALK	390 kW		09/02→			
26.530 FDAS, FDALS	390 kW		07/06→			
27.440 FDS, FDLS, FDRS, FDLRS	324 kW		10/08→			
28.310, 28.320 FNLC, FNLLC, FNLL-LE, FNLLR-LE	228 - 235 kW		07/06→			
28.310, 28.320 FNLC, FNLLC, FNLLRC, FNLLR-LE	228 - 235 kW		07/06→			
28.310 FNLS, FNLSRS	228 kW		06/04→			
28.320 FNLC, FNLLC, FNLSRC	235 kW		06/04→			
28.320 FNLS, FNLSRS	235 kW		06/04→			
28.350, 28.360 FNLC, FNLLC, FNLL-LE	257 - 265 kW		07/06→			
28.350, 28.360 FNLC, FNLLC, FNLSRC, FNLL-LE	257 - 265 kW		06/04→			
28.350 FANLC	257 kW		07/06→			
28.350 FANLK	257 kW		07/06→			
28.360 FANLC	265 kW		07/06→			
28.360 FANLK	265 kW		07/06→			
28.360 FNLS, FNLSRS-WW	265 kW		04/06→			
28.390, 28.400 FNLC, FNLLC, FNLSRC-WW	287 - 294 kW		06/04→			
28.390 FANLC	287 kW		07/06→			
28.390 FANLK	287 kW		07/06→			
28.390 FNLLC	353 kW		07/06→			
28.400 FANLC	294 kW		07/06→			
28.400 FANLK	294 kW		07/06→			
28.400 FNLS, FNLSRS	294 kW		04/06→			
28.410 FANLC	301 kW		07/06→			
28.410 FANLK	301 kW		07/06→			
28.430, 28.440 FNLC, FNLLC, FNLSRC-WW	316 - 324 kW		06/04→			
28.430 FANLC	316 kW		07/06→			
28.430 FANLK	316 kW		07/06→			
28.440 FANLC	324 kW		07/06→			
28.440 FANLK	324 kW		07/06→			
28.440 FNLS, FNLSRS-WW	324 kW		09/05→			
28.480 FANLC	353 kW		07/06→			

Manufacturer - Model	Power	Displ.	Year of Constr.	Remark	Part Number	Page
MAN - TGA						04/00→
28.480 FANLK	353 kW		07/06→	Front; L 700 mm; Quantity: 1	9XW 184 107-281 Wiper 112 Blade	
28.530 FANLK	390 kW		07/06→			
28.530 FANLK	390 kW		07/06→	Front; Length [in]: 28; L 700 mm; Quantity: 1	9XW 191 397-281 Wiper 115 Blade	
28.540 FNLC, FNLLC	397 kW		08/06→			
28.540 FNLS	397 kW		08/06→			
32.350, 32.360 FFDRC	257 - 265 kW		05/04→			
32.350, 32.360 FFD-TM, FFDRC-TM	257 - 265 kW		02/04→			
32.390, 32.400 FFDRC	287 - 294 kW		05/04→			
32.390, 32.400 FFD-TM, FFDRC-TM	287 - 294 kW		05/04→			
32.430, 32.440 FFDRC	316 - 324 kW		05/04→			
32.430, 32.440 FFD-TM, FFDRC-TM	316 - 324 kW		05/04→			
32.480 FFDRC	353 kW		02/06→			
32.480 FFD-TM, FFDRC-TM	353 kW		02/06→			
33.350 FDC-TM, FDCRC-TM	257 kW		09/07→			
33.360 FDC-TM, FDCRC-TM	265 kW		09/07→			
33.390, 33.400 FDC-TM, FDCRC-TM	287 - 294 kW		09/07→			
33.430, 33.440 FDAK, FDALK, FDHK	316 - 324 kW		06/05→			
33.430, 33.440 FDAS, FDALS, FDHS	316 - 324 kW		06/05→			
33.440 FDC-TM, FDCRC-TM	324 kW		09/07→			
33.460 FDAC-WW	338 kW		09/02→			
33.460 FDAK-WW	338 kW		09/02→			
33.460 FDAS-WW	338 kW		09/02→			
33.480 FDAC, FDALC, FDHC, FDHC/M	353 kW		02/06→			
33.480 FDAK, FDALK, FDHK	353 kW		02/06→			
33.480 FDAS, FDALS, FDHS	353 kW		02/06→			
33.480 FDC-TM, FDCRC-TM	353 kW		09/07→			
33.480 FDS, FDRS, FDLS, FDS/M	353 kW		01/06→			
33.530 FDS, FDLS, FDLS/M, FDRS, FDLRS	390 kW		07/03→			
35.350 FFDHK, FFDHLK	257 kW		07/06→			
35.350 FFDH-TM	257 kW		07/06→			
35.350 FFNLC	257 kW		07/06→			
35.360 FFDHK, FFDHLK	265 kW		07/06→			
35.360 FFDH-TM	265 kW		07/06→			
35.360 FFNHLC	265 kW		07/06→			
35.360 FFNLC	265 kW		07/06→			
35.390 FDNLC	287 kW		07/06→			
35.390 FFDAK, FFDHK, FFDHLK	287 kW		07/06→			
35.390 FFDH-TM	287 kW		07/06→			
35.390 FFNLC	287 kW		07/06→			
35.400 FDNLC	294 kW		07/06→			
35.400 FFDAK	294 kW		02/04→			
35.400 FFDAK, FFDHK, FFDHLK	294 kW		07/06→			
35.400 FFDH-TM	294 kW		07/06→			
35.400 FFNHLC	294 kW		11/06→			
35.400 FFNLC	294 kW		07/06→			
35.410 FDNLC	301 kW		07/06→			
35.410 FFDAK	301 kW		07/06→			
35.410 FFNLC	301 kW		07/06→			
35.430 FDNLC	316 kW		07/06→			
35.430 FFDAK, FFDHK, FFDHLK	316 kW		07/06→			
35.430 FFDH-TM	316 kW		07/06→			
35.430 FFNLC	316 kW		07/06→			
35.440 FDNLC	324 kW		07/06→			
35.440 FFDAK, FFDHK, FFDHLK	324 kW		07/06→			
35.440 FFDH-TM	324 kW		07/06→			
35.440 FFNHLC	324 kW		11/06→			
35.440 FFNLC	324 kW		07/06→			
35.460 FFNLC	338 kW		07/06→			
35.480 FDNLC	353 kW		07/06→			
35.480 FFDAK	353 kW		07/06→			
35.480 FFDAK, FFDHK, FFDHLK	353 kW		07/06→			
35.480 FFDARS	353 kW		07/06→			
35.480 FFDH-TM	353 kW		07/06→			
35.480 FFNHLC	353 kW		11/06→			
35.480 FFNLC	353 kW		07/06→			
35.530 FDNLC	390 kW		04/04→			
35.530 FFDAK	390 kW		07/06→			
35.530 FFNLC	390 kW		07/06→			
37.530 FVDS, FVDLS	390 kW		07/06→			
39.390 FVNLC	287 kW		07/06→			
39.400 FVNLC	294 kW		07/06→			
39.430 FVNLC	316 kW		07/06→			

Manufacturer - Model	Power	Displ.	Year of Constr.	Remark	Part Number	Page
MAN - TGA						04/00→
39.440 FVNLC	324 kW		07/06→	Front; L 700 mm; Quantity: 1	9XW 184 107-281 Wiper 112 Blade	
39.480 FVNLC	353 kW		07/06→			
40.390, 40.400 FDAK-WW	287 - 294 kW		06/05→	Front; Length [in]: 28; L 700 mm; Quantity: 1	9XW 191 397-281 Wiper 115 Blade	
40.390, 40.400 FDAS-WW	287 - 294 kW		06/05→			
40.410 FDAK-WW	301 kW		04/04→			
40.410 FDAS-WW	301 kW		04/04→			
40.430, 40.440 FDAK-WW	316 - 324 kW		06/05→			
40.430, 40.440 FDAS-WW	316 - 324 kW		06/05→			
40.460 FDAK-WW	338 kW		04/04→			
40.460 FDAS-WW	338 kW		04/04→			
40.480 FDAK-WW	353 kW		04/04→			
40.480 FDAK-WW	353 kW		06/05→			
40.480 FDAS-WW	353 kW		04/04→			
40.480 FDAS-WW	353 kW		06/05→			
41.350 FFDC-TM, FFDRC-TM	257 kW		09/07→			
41.360 FFD	265 kW		12/08→			
41.360 FFDC-TM, FDRC-TM	265 kW		09/07→			
41.390 FFDC-TM, FDRC-TM	287 kW		09/07→			
41.400 FFD	294 kW		12/08→			
41.400 FFDC-TM, FDRC-TM	294 kW		09/07→			
41.410 FFDAK	301 kW		07/06→			
41.430 FFDAK	316 kW		07/06→			
41.430 FFDC-TM, FFDRC	316 kW		09/07→			
41.440 FFDAK	324 kW		07/06→			
41.440 FFDC-TM, FFDRC-TM	324 kW		09/07→			
41.480 FFD	353 kW		12/08→			
41.480 FFDARC	353 kW		07/06→			
41.480 FFDC-TM, FFDRC-TM	353 kW		09/07→			
41.480 FFD-TM	353 kW		02/06→			
41.480 FVDS, FVDLS	353 kW		07/06→			
41.530 FFDAK	353 kW		07/06→			
41.530 FFDAK	390 kW		07/06→			
41.530 FFD-TM	390 kW		12/04→			
41.540 FVDS, FVDLS	397 kW		11/06→			
MAN - TGL						04/05→
10.180 FC, FRC, FLC, FLRC	132 kW		04/05→	Delivery Quantity [l/h]: 432; elec.; Blade Terminal; Pressure [bar]: 2.5; Pressure hose connector diameter [mm]: 11; Mono Pump; 24 V; Suction pipe connector diameter [mm]: 10.5	8TW 004 764-041 Water 110 Pump, headlight cleaning	
10.180 FK, FRK	132 kW		04/05→			
10.210 FC, FRC, FLC, FLRC	151 kW		04/05→			
10.210 FK, FRK	151 kW		04/05→			
10.220 FC, FLC, FRC, FLRC	162 kW		04/05→	use plug 81.25435-0134; cap 81.26412-0013; cap 81.96410-0342 as well, according to plug connection (MAN) ; Delivery Quantity [l/h]: 432; Housing Diameter [mm]: 35; elec.; Pressure [bar]: 2.5; Pressure hose connector diameter [mm]: 11; Mono Pump; Quantity: 32; 24 V; Suction pipe connector diameter [mm]: 10.5	8TW 007 540-037 Water 110 Pump, headlight cleaning	
10.220 FK, FRK	162 kW		04/05→			
10.240 FC, FRC, FLC, FLRC	176 kW		04/05→			
10.240 FK, FRK	176 kW		04/05→			
10.250 FC, FLC, FRC, FLRC	184 kW		04/05→			
10.250 FK, FRK	184 kW		04/05→			
12.180 FC, FRC, FLC, FLRC	132 kW		04/05→	Front; L 700 mm; Quantity: 1	9XW 184 107-281 Wiper 112 Blade	
12.180 FK, FRK	132 kW		04/05→			
12.210 FC, FRC, FLC, FLRC	151 kW		04/05→	Front; Length [in]: 28; L 700 mm; Quantity: 1	9XW 191 397-281 Wiper 115 Blade	
12.210 FK, FRK	151 kW		04/05→			
12.220 FC, FRC, FLC, FLRC	162 kW		04/05→			
12.220 FK, FRK	162 kW		04/05→			
12.240 FC, FRC, FLC, FLRC	176 kW		04/05→			
12.240 FK, FRK	176 kW		04/05→			
12.250 FC, FLC, FRC, FLRC	184 kW		04/05→			
12.250 FK, FRK	184 kW		04/05→			
7.150, 8.150 FC, FRC, FLC, FLRC	110 kW		04/05→			
7.180 FC, FLC, FRC, FLRC	132 kW		04/05→			
7.220 FC, FLC, FRC, FLRC	162 kW		04/05→			
7.250 FC, FLC, FRC, FLRC	184 kW		04/05→			
8.180 FC, FRC, FLC, FLRC	132 kW		04/05→			
8.180 FK, FK-L, FRK, FRK-L	132 kW		04/05→			
8.210 FC, FRC, FLC, FLRC	151 kW		04/05→			
8.210 FK, FK-L, FRK, FRK-L	151 kW		04/05→			
8.220 FC, FLC, FRC, FLRC	162 kW		04/05→			
8.220 FK, FRK, FK-L, FRK-L	162 kW		04/05→			
8.240 FC, FRC, FLC, FLRC	176 kW		04/05→			
8.240 FK, FK-L, FRK, FRK-L	176 kW		04/05→			
8.250 FC, FLC, FLRC, FRC	184 kW		04/05→			
8.250 FK, FK-L, FRK, FRK-L	184 kW		04/05→			
8.150 FK, FRK, FK-L, FRK-L	110 kW		10/06→	Front; L 700 mm; Quantity: 1	9XW 184 107-281 Wiper 112 Blade	
				Front; Length [in]: 28; L 700 mm; Quantity: 1	9XW 191 397-281 Wiper 115 Blade	
MAN - TGM						10/05→
12.240 FLC, FLLC	176 kW		10/05→	Front; L 700 mm; Quantity: 1	9XW 184 107-281 Wiper 112 Blade	
12.250 FLC, FLLC	184 kW		10/05→			
12.280 FC, FLC, FLLC	206 kW		10/05→			

Manufacturer - Model	Power	Displ.	Year of Constr.	Remark	Part Number	Page
MAN - TGM						10/05→
12.290 FLC, FLLC	213 kW		10/05→	Front; Length [in]: 28; L 700 mm; Quantity: 1	9XW 191 397-281 Wiper 115 Blade	
13.240 FAL, FALC, FALRC, FAEC, FAERC, FALR	176 kW		04/06→			
13.240 FALK, FALRK, FALK-L, FALRK-L	176 kW		04/06→			
13.250 FAEC, FAERC, FALC, FAL, FALRC, FALR	184 kW		10/05→			
13.250 FALK, FALRK, FALK-L, FALRK-L	184 kW		10/05→			
13.280 FAEC, FAERC, FAL, FALC, FALRC	206 kW		04/06→			
13.280 FALK, FALRK, FALK-L, FALRK-L	206 kW		04/06→			
13.290 FAEC, FAERC, FAL, FALR, FALC, FALRC	213 kW		10/05→			
13.290 FALK, FALRK, FALK-L, FALRK-L	213 kW		10/05→			
15.240 FC, FLC, FLLC, FLRC, FLLRC	176 kW		10/05→			
15.240 FLK, FLRK	176 kW		10/05→			
15.250 FC, FLC, FLRC, FLLC, FLLRC	184 kW		10/05→			
15.250 FLK, FLRK	184 kW		10/05→			
15.280 FC, FLC, FLLC, FLRC, FLLRC	206 kW		10/05→			
15.280 FLK, FLRK	206 kW		10/05→			
15.290 FC, FLC, FLRC, FLLC, FLLRC	213 kW		10/05→			
15.290 FLK, FLRK	213 kW		10/05→			
15.330 FC, FLC, FRC, FLRC	240 kW		10/05→			
15.330 FLK, FLRK	240 kW		10/05→			
15.340 FC, FLC, FLRC	250 kW		10/05→			
15.340 FLK, FLRK	250 kW		10/05→			
18.240 FAC, FARC	176 kW		10/05→			
18.240 FAK, FARK, FAK-L, FARK-L	176 kW		05/06→			
18.250 FAC, FARC	184 kW		10/05→			
18.250 FAK, FARK, FAK-L, FARK-L	184 kW		10/05→			
18.250 FC, FLC, FLLC, FRC, FLRC, FLLRC	184 kW		10/05→			
18.250 FK, FLK, FRK, FLRK	184 kW		10/05→			
18.280 FAC, FARC	206 kW		10/05→			
18.280 FAK, FARK, FAK-L, FARK-L	206 kW		10/05→			
18.290 FAC, FARC	213 kW		10/05→			
18.290 FAK, FARK, FAK-L, FARK-L	213 kW		10/05→			
18.290 FC, FLC, FRC, FLRC, FLLC, FLLRC	213 kW		10/05→			
18.290 FK, FLK, FRK, FLRK	213 kW		10/05→			
18.330 FAC, FARC	240 kW		10/05→			
18.330 FAK, FARK, FAK-L, FARK, L	240 kW		10/05→			
18.340 FAC, FARC	250 kW		10/05→			
18.340 FAK, FARK, FAK-L, FARK-L	250 kW		10/05→			
18.340 FC, FLC, FLRC, FLLC, FLLRC, FRC	250 kW		10/05→			
18.340 FK, FRK, FLK, FLRK	250 kW		10/05→			
22.240 FNLLC	176 kW		10/05→			
22.250 FNLLC	184 kW		10/05→			
22.280 FNL, 22.280 FNLLC	206 kW		10/05→			
22.290 FNL, 22.290 FNLLC	213 kW		10/05→			
26.280 FD	206 kW		10/05→			
26.280 FDK-HK, FDRK-HK	206 kW		04/06→			
26.280 FD-TM, FDR-TM	206 kW		04/06→			
26.280 FNLC, FNLLC, FNLR, FNLLRC	206 kW		10/05→			
26.290 FD, FDR	213 kW		10/05→			
26.290 FDK-HK, FDRK-HK	213 kW		10/05→			
26.290 FD-TM, FDR-TM	213 kW		07/08→			
26.290 FNLC, FNLLC, FNLR, FNLLRC, FVL	213 kW		10/05→			
26.330 FD, FDR	240 kW		10/05→			
26.330 FDK-HK, FDRK-HK	240 kW		04/06→			
26.330 FD-TM, FDR-TM	240 kW		04/06→			
26.330 FNLC, FNLLC, FNLR, FNLLRC, FVL	240 kW		10/05→			
26.340 FD, FDR	250 kW		10/05→			
26.340 FDK-HK, FDRK-HK	250 kW		10/05→			

Manufacturer - Model	Power	Displ.	Year of Constr.	Remark	Part Number	Page
MAN - TGM						10/05→
26.340 FD-TM, FDR-TM	250 kW		07/08→			
26.340 FNLC, FNLLC, FNLR, FNLLRC	250 kW		10/05→			
18.240 FC, FRC, FLC, FLRC, FLLC, FLLRC	176 kW		10/05→	Delivery Quantity [l/h]: 432; elec.; Blade Terminal; Pressure [bar]: 2.5; Pressure hose connector diameter [mm]: 11; Mono Pump; 24 V; Suction pipe connector diameter [mm]: 10.5	8TW 004 764-041	Water 110 Pump, headlight cleaning
18.240 FK, FRK, FLK, FK-L, FLRK	176 kW		10/05→			
18.280 FC, FRC, FLC, FLRC, FLLC, FLLRC	206 kW		10/05→	use plug 81.25435-0134; cap 81.26412-0013; cap 81.96410-0342 as well, according to plug connection (MAN) ; Delivery Quantity [l/h]: 432; Housing Diameter [mm]: 35; elec.; Pressure [bar]: 2.5; Pressure hose connector diameter [mm]: 11; Mono Pump; Quantity: 32; 24 V; Suction pipe connector diameter [mm]: 10.5	8TW 007 540-037	Water 110 Pump, headlight cleaning
18.280 FK, FLK, FRK, FLRK, FK-L	206 kW		10/05→			
18.330 FC, FRC, FLC, FLRC, FLLC, FLLRC	240 kW		10/05→			
18.330 FK, FLK, FRK, FLRK, FK-L	240 kW		10/05→	Front; L 700 mm; Quantity: 1	9XW 184 107-281	Wiper 112 Blade
				Front; Length [in]: 28; L 700 mm; Quantity: 1	9XW 191 397-281	Wiper 115 Blade
MAN - TGS						09/07→
18.320 FAC, FHLC	235 kW		10/07→	Front; L 700 mm; Quantity: 1	9XW 184 107-281	Wiper 112 Blade
18.320 FAK, FAK-L, FALK, FALK-L, FHLK, FHLK/M	235 kW		10/07→	Front; Length [in]: 28; L 700 mm; Quantity: 1	9XW 191 397-281	Wiper 115 Blade
18.320 FAS, FHLS, FHLS/M	235 kW		10/07→			
18.320 FC, FLC, FLRC, FLLC, FLLRC, FLLW, FLLW/N	235 kW		10/07→			
18.320 FK, FK-L, FLK, FLK/M	235 kW		10/07→			
18.320 FLS, FLS/M, FLS-TS, FLRS, FLRS/M, FLLS, FLLS/N, FLLRS	235 kW		10/07→			
18.360 FAC, FHLC	265 kW		10/07→			
18.360 FAK, FAK-L, FALK, FALK-L, FHLK, FHLK/M	265 kW		10/07→			
18.360 FAS, FALS, FHLS, FHLS/M	265 kW		10/07→			
18.360 FC, FLC, FLRC, FLLC, FLLRC, FLLW, FLLW/N	265 kW		10/07→			
18.360 FK, FK-L, FLK, FLK/M	265 kW		10/07→			
18.360 FLS, FLS/M, FLS-TS, FLRS, FLRS/M, FLLS, FLLS/N, FLLRS	265 kW		10/07→			
18.400 FAC, FHLC	294 kW		10/07→			
18.400 FAK, FAK-L, FALK, FALK-L, FHLK, FHLK/M	294 kW		10/07→			
18.400 FAS, FALS, FHLS, FHLS/M	294 kW		10/07→			
18.400 FC, FLC, FLRC, FLLC, FLLRC, FLLW, FLLW/N	294 kW		10/07→			
18.400 FK, FK-L, FLK, FLK/M	294 kW		10/07→			
18.400 FLS, FLS/M, FLS-TS, FLRS, FLRS/M, FLLS, FLLS/N, FLLRS	294 kW		10/07→			
18.440 FAC, FHLC	324 kW		10/07→			
18.440 FAK, FAK-L, FALK, FALK-L, FHLK, FHLK/M	324 kW		10/07→			
18.440 FAS, FALS, FHLS, FHLS/M	324 kW		10/07→			
18.440 FC, FLC, FLRC, FLLC, FLLRC, FLLW, FLLW/N	324 kW		10/07→			
18.440 FK, FK-L, FLK, FLK/M	324 kW		10/07→			
18.440 FLS, FLS/M, FLS-TS, FLRS, FLRS/M, FLLS, FLLS/N, FLLRS	324 kW		10/07→			
18.480 FAC, FHLC	353 kW		10/07→			
18.480 FAK, FAK-L, FALK, FALK-L, FHLK, FHLK/M	353 kW		10/07→			
18.480 FAS, FALS, FHLS, FHLS/M	353 kW		10/07→			
18.480 FC, FLC, FLRC, FLLC, FLLRC, FLLW, FLLW/N	353 kW		10/07→			
18.480 FK, FK-L, FLK, FLK/M	353 kW		10/07→			
18.480 FLS, FLS/M, FLS-TS, FLRS, FLRS/M, FLLS, FLLS/N, FLLRS	353 kW		10/07→			
18.540 FAC, FHLC	397 kW		10/07→			
18.540 FAK, FAK-L, FALK, FALK-L, FHLK, FHLK/M	397 kW		10/07→			
18.540 FAS, FALS, FHLS, FHLS/M	397 kW		10/07→			
18.540 FC, FLC, FLRC, FLLC, FLLRC, FLLW, FLLW/N	397 kW		10/07→			
18.540 FK, FK-L, FLK, FLK/M	397 kW		10/07→			

Manufacturer - Model	Power	Displ.	Year of Constr.	Remark	Part Number	Page
MAN - TGS						09/07→
18.540 FLS, FLS/M, FLRS, FLRS/M, FLLS, FLLS/N, FLLRS	397 kW		10/07→	Front; L 700 mm; Quantity: 1	9XW 184 107-281 Wiper 112 Blade	
19.360 FS/M-WW, FLS/M-WW, FRS/M-WW, FLRS/M-WW	265 kW		02/11→	Front; Length [in]: 28; L 700 mm; Quantity: 1	9XW 191 397-281 Wiper 115 Blade	
19.400 FS/M-WW, FLS/M-WW, FRS/M-WW, FLRS/M-WW	294 kW		02/11→			
19.440 FS-WW, FRS-WW, FLS-WW, FLRS-WW	324 kW		02/11→			
19.480 FS/M-WW, FRS/M-WW, FLS/M-WW, FLRS/M-WW	353 kW		02/11→			
24.320 FNLLW/N	235 kW		10/07→			
24.360 FNLLW/N	265 kW		10/07→			
24.360 FPLS, FPLRS	265 kW		10/07→			
24.400 FNLLW/N	294 kW		10/07→			
24.400 FPLS, FPLRS	294 kW		10/07→			
24.440 FNLLW/N	324 kW		10/07→			
24.440 FPLS, FPLRS	324 kW		10/07→			
24.480 FPLS, FPLRS	353 kW		10/07→			
24.540 FPLS, FPLRS	397 kW		10/07→			
26.320 FDAC, FDALC, FDHLC, FDHLC/M	235 kW		07/08→			
26.320 FDAK, FDALK, FDHK, FDHLK	235 kW		07/08→			
26.320 FDAS, FDALS, FDHS, FDHLS, FDHLS/M	235 kW		07/08→			
26.320 FDC, FDRC, FDLC, FDLC/M, FDLRC, FDLRC/M, FNHLC	235 kW		07/08→			
26.320 FDK, FDLK	235 kW		07/08→			
26.320 FDS, FDLS, FDLS/M, FDRS, FDLRS, FDLRS/M, FNHLS	235 kW		07/08→			
26.320 FD-TM	235 kW		07/08→			
26.320 FNLC, FNLRC, FNLLC, FNLLRC, FNLLW, FVLC, FVL-KO	235 kW		10/07→			
26.320 FNLS, FNLS, FNLLS, FPLS, FVLS	235 kW		07/08→			
26.320 FVHLC	235 kW		10/07→			
26.360 FDAC, FDALC, FDHLC, FDHLC/M	265 kW		08/08→			
26.360 FDAK, FDALK, FDHK, FDHLK	265 kW		08/08→			
26.360 FDAS, FDALS, FDHS, FDHLS, FDHLS/M	265 kW		08/08→			
26.360 FDC, FDRC, FDRC/M, FDLC, FDLRC, FNHLC	265 kW		08/08→			
26.360 FDK, FDLK, FDRK	265 kW		08/08→			
26.360 FDS, FDRS, FDRS/M, FDLS, FDLRS, FNHLS	265 kW		08/08→			
26.360 FD-TM	265 kW		07/08→			
26.360 FNLC, FNLRC, FNLLC, FNLLRC, FVLC, FVL-KO	265 kW		10/07→			
26.360 FNLLW	265 kW		04/08→			
26.360 FNLS, FNLS, FNLS, FPLS, FPLRS, FVLS	265 kW		08/08→			
26.360 FPHLS	265 kW		05/08→			
26.360 FVHLC	265 kW		10/07→			
26.360 FVHLS	265 kW		05/08→			
26.400 FDAC, FDALC, FDHLC, FDHLC/M	294 kW		02/09→			
26.400 FDAK, FDALK, FDHK, FDHLK	294 kW		11/07→			
26.400 FDAS, FDALS, FDHS, FDHLS, FDHLS/M	294 kW		09/07→			
26.400 FDC, FDRC, FDC/M, FDLC, FDLC/M, FDLRC, FDLRC/M, FNHLC	294 kW		08/08→			
26.400 FDK, FDLK	294 kW		02/09→			
26.400 FDS, FDS/M, FDLS, FDLS/M, FDRS, FDLRS, FNHLS	294 kW		02/09→			
26.400 FD-TM	294 kW		07/08→			
26.400 FNLC, FNLRC, FNLLC, FNLLRC, FVLC, FVL-KO, FNLLW	294 kW		10/07→			
26.400 FNLS, FNLS, FNLS, FNLLRS, FPLS, FPLRS, FVLS	294 kW		02/09→			
26.400 FPHLS	294 kW		05/08→			
26.400 FVHLC	294 kW		10/07→			
26.400 FVHLS	294 kW		05/08→			

Manufacturer - Model	Power	Displ.	Year of Constr.	Remark	Part Number	Page
MAN - TGS						09/07→
32.400 FFD-TM, FFDR-TM	294 kW		10/07→	Front; L 700 mm; Quantity: 1	9XW 184 107-281 Wiper 112 Blade	
32.440 FFDR	324 kW		08/08→			
32.440 FFD-TM, FFDR-TM	324 kW		10/07→	Front; Length [in]: 28; L 700 mm; Quantity: 1	9XW 191 397-281 Wiper 115 Blade	
32.480 FFD-TM	353 kW		08/08→			
33.360 FDAC, FDALC	265 kW		06/08→			
33.360 FDAK, FDALK, FDHK	265 kW		10/07→			
33.360 FDAS, FDALS, FDHS	265 kW		10/07→			
33.360 FDC, FDLC	265 kW		06/08→			
33.360 FDK, FDLK	265 kW		02/09→			
33.360 FDS, FDSL	265 kW		06/08→			
33.400 FDAC, FDALC	294 kW		07/08→			
33.400 FDAK, FDALK, FDHK	294 kW		07/08→			
33.400 FDAS, FDALS, FDHS	294 kW		07/08→			
33.400 FDC, FDLC	294 kW		06/08→			
33.400 FDK, FDLK	294 kW		07/08→			
33.400 FDS, FDSL	294 kW		07/08→			
33.440 FDAC, FDALC	324 kW		07/08→			
33.440 FDAK, FDALK, FDHK	324 kW		11/07→			
33.440 FDAS, FDALS, FDHS	324 kW		10/07→			
33.440 FDC, FDLC	324 kW		06/08→			
33.440 FDK, FDLK	324 kW		06/08→			
33.440 FDS, FDSL, FDSL/M	324 kW		06/08→			
33.480 FDAC, FDALC	353 kW		08/08→			
33.480 FDAK, FDALK	353 kW		08/08→			
33.480 FDAS, FDALS, FDHS	353 kW		10/07→			
33.480 FDC, FDC/M, FDLC, FDLC/M	353 kW		08/08→			
33.480 FDK, FDLK	353 kW		08/08→			
33.480 FDS, FDSL, FDSL/M	353 kW		08/08→			
33.540 FDAC, FDALC	397 kW		02/09→			
33.540 FDAK, FDALK	397 kW		02/09→			
33.540 FDAS, FDALS	397 kW		02/09→			
33.540 FDC, FDLC, FDLC/M	397 kW		02/09→			
33.540 FDK, FDLK	397 kW		02/09→			
33.540 FDS, FDSL, FDSL/M	397 kW		02/09→			
35.320 FFDAK	235 kW		06/08→			
35.320 FFDAK, FFDHLK	235 kW		06/08→			
35.320 FFDC, FFDLC, FDNLC	235 kW		06/08→			
35.320 FFDK, FFDLK	235 kW		08/08→			
35.320 FFD-TM	235 kW		10/07→			
35.320 FFNLC	235 kW		01/09→			
35.360 FFDAK	265 kW		06/08→			
35.360 FFDAK, FFHDLK	265 kW		06/08→			
35.360 FFDC, FFDLC, FDNLC	265 kW		06/08→			
35.360 FFDK, FFDLK, FFDRK	265 kW		08/08→			
35.360 FFD-TM	265 kW		10/07→			
35.360 FFNLC	265 kW		06/08→			
35.400 FFDAK	294 kW		06/08→			
35.400 FFDAK, FFDHLK	294 kW		06/08→			
35.400 FFDC, FFDLC, FDNLC	294 kW		06/08→			
35.400 FFDK, FFDLK, FFDRK	294 kW		08/08→			
35.400 FFD-TM	294 kW		10/07→			
35.400 FFNHLC	294 kW		10/07→			
35.400 FFNLC	294 kW		06/08→			
35.440 FDNLC, FFDC, FFDLC, FFNLC	324 kW		06/08→			
35.440 FFDAK	324 kW		06/08→			
35.440 FFDAK, FFDHLK	324 kW		06/08→			
35.440 FFDK, FFDLK, FFDRK	324 kW		08/08→			
35.440 FFD-TM	324 kW		10/07→			
35.440 FFNHLC	324 kW		10/07→			
35.440 FFNLC	324 kW		06/08→			
35.480 FDNLC, FFDC, FFDLC	353 kW		06/08→			
35.480 FFDAK	353 kW		06/08→			
35.480 FFDAK, FFDHLK	353 kW		06/08→			
35.480 FFDK, FFDLK, FFDRK	353 kW		08/08→			
35.480 FFD-TM	353 kW		10/07→			
35.480 FFNHLC	353 kW		10/07→			
35.480 FFNLC	353 kW		06/08→			
35.540 FDNLC, FFDC, FFDLC	397 kW		06/08→			
35.540 FFDAK	397 kW		02/09→			
35.540 FFDAK, FFDHLK	397 kW		02/09→			
35.540 FFDK, FFDLK, FFDRK	397 kW		02/09→			
35.540 FFD-TM	397 kW		10/07→			
35.540 FFNLC	397 kW		02/09→			
37.320 FFDC	235 kW		07/08→			
37.320 FFDK	235 kW		07/08→			
37.320 FFD-TM	235 kW		10/07→			
37.360 FFDC	265 kW		07/08→			
37.360 FFDK	265 kW		07/08→			
37.360 FFD-TM	265 kW		10/07→			

Manufacturer - Model	Power	Displ.	Year of Constr.	Remark	Part Number	Page
MAN - TGS						09/07→
37.400 FFDC	294 kW		07/08→	Front; L 700 mm; Quantity: 1	9XW 184 107-281 Wiper 112 Blade	
37.400 FFDK	294 kW		07/08→			
37.400 FFD-TM	294 kW		10/07→	Front; Length [in]: 28; L 700 mm; Quantity: 1	9XW 191 397-281 Wiper 115 Blade	
37.440 FFDC	324 kW		07/08→			
37.440 FFDK	324 kW		07/08→			
37.440 FFD-TM	324 kW		10/07→			
37.480 FFDC	353 kW		07/08→			
37.480 FFDK	353 kW		07/08→			
37.480 FFD-TM	353 kW		10/07→			
37.540 FFDC	397 kW		02/09→			
37.540 FFDK	397 kW		02/09→			
37.540 FFD-TM	397 kW		10/07→			
40.400 FDAK-WW, FDARK-WW	294 kW		02/11→			
40.400 FDAS-WW, FDARS-WW	294 kW		02/11→			
40.440 FDAK-WW, FDARK-WW	324 kW		02/11→			
40.440 FDAS-WW, FDARS-WW	324 kW		02/11→			
41.320 FFDAK	235 kW		06/08→			
41.360 FFDAK	265 kW		06/08→			
41.360 FFDC	265 kW		07/08→			
41.360 FFDK	265 kW		07/08→			
41.360 FFD-TM	265 kW		10/07→			
41.400 FFDC	294 kW		07/08→			
41.400 FFDK	294 kW		07/08→			
41.400 FFD-TM	294 kW		10/07→			
41.440 FFDAK	324 kW		06/08→			
41.440 FFDC	324 kW		07/08→			
41.440 FFDK	324 kW		07/08→			
41.440 FFD-TM	324 kW		10/07→			
41.480 FFDAK	353 kW		06/08→			
41.480 FFDARC	353 kW		06/08→			
41.480 FFDC	353 kW		07/08→			
41.480 FFDK	353 kW		07/08→			
41.480 FFD-TM	353 kW		10/07→			
41.540 FFDAK	397 kW		02/09→			
41.540 FFDC	397 kW		02/09→			
41.540 FFDK	397 kW		02/09→			
41.540 FFD-TM	397 kW		10/07→			
MAN - TGX						09/07→
18.360 FHLC	265 kW		10/07→	Front; L 700 mm; Quantity: 1	9XW 184 107-281 Wiper 112 Blade	
18.360 FHLS, FHLS/M	265 kW		10/07→			
18.360 FLC, FLRC, FLLC, FLLRC, FLLW, FLLW/N	265 kW		10/07→	Front; Length [in]: 28; L 700 mm; Quantity: 1	9XW 191 397-281 Wiper 115 Blade	
18.360 FLS, FLS/M, FLRS, FLRS/N, FLLS, FLLS/N, FLLRS, FLLRS/N	265 kW		10/07→			
18.400 FHLC	294 kW		10/07→			
18.400 FHLS, FHLS/M	294 kW		10/07→			
18.400 FLC, FLRC, FLLC, FLLRC, FLLW, FLLW/N	294 kW		10/07→			
18.400 FLS, FLS/M, FLRS, FLRS/N, FLLS, FLLS/N, FLLRS, FLLRS/N	294 kW		10/07→			
18.440 FHLC	324 kW		10/07→			
18.440 FHLS, FHLS/M	324 kW		10/07→			
18.440 FLC, FLRC, FLLC, FLLRC, FLLW, FLLW/N	324 kW		10/07→			
18.440 FLRC	324 kW		10/07→			
18.440 FLRS	324 kW		10/07→			
18.440 FLS, FLS/M, FLRS, FLRS/M, FLLS, FLLS/N, FLLRS, FLLRS/N	324 kW		10/07→			
18.480 FHLC	353 kW		10/07→			
18.480 FHLS, FHLS/M	353 kW		10/07→			
18.480 FLC, FLRC, FLLC, FLLRC, FLLW, FLLW/N	353 kW		10/07→			
18.480 FLS, FLS/M, FLRS, FLRS/N, FLLS, FLLS/N, FLLRS, FLLRS/N	353 kW		10/07→			
18.540 FHLC	397 kW		10/07→			
18.540 FHLS, FHLS/M	397 kW		10/07→			
18.540 FLC, FLRC, FLLC, FLLRC, FLLW, FLLW/N	397 kW		10/07→			
18.540 FLS, FLS/M, FLRS, FLRS/N, FLLS, FLLS/N, N, FLLRS, FLLRS/N	397 kW		10/07→			
18.680 FLS	500 kW		10/07→			
24.360 FNLLW/N	265 kW		10/07→			
24.360 FPLS, FPLRS	265 kW		10/07→			
24.400 FNLLW/N	294 kW		10/07→			
24.400 FPLS, FPLRS	294 kW		10/07→			

Manufacturer - Model	Power	Displ.	Year of Constr.	Remark	Part Number	Page
MAN - TGX						09/07→
24.440 FNLLW/N	324 kW		10/07→	Front; L 700 mm; Quantity: 1	9XW 184 107-281 Wiper 112 Blade	
24.440 FPLRS	324 kW		10/07→			
24.440 FPLS, FPLRS	324 kW		10/07→	Front; Length [in]: 28; L 700 mm; Quantity: 1	9XW 191 397-281 Wiper 115 Blade	
24.480 FNLLW/N	353 kW		10/07→			
24.480 FPLS, FPLRS	353 kW		10/07→			
24.540 FNLLW/N	397 kW		02/09→			
24.540 FPLS, FPLRS	397 kW		10/07→			
26.320 FNLS, FNLLS	235 kW		10/07→			
26.360 FDC, FDLC, FDRC, FDLRC	265 kW		07/08→			
26.360 FDHLC	265 kW		10/07→			
26.360 FDHLS	265 kW		10/07→			
26.360 FDS, FDLS, FDRS, FDLRS	265 kW		07/08→			
26.360 FNHLC	265 kW		10/07→			
26.360 FNHLS	265 kW		12/07→			
26.360 FNLC, FNLRC, FNLLC, FNLLRC, FNLLW	265 kW		10/07→			
26.360 FNLS, FNLLS, FNLRS, FNLLRS, FPLS, FPLRS, FVLS	265 kW		10/07→			
26.360 FVHLS	265 kW		05/08→			
26.400 FDC, FDLC, FDRC, FDLRC	294 kW		07/08→			
26.400 FDHLC	294 kW		10/07→			
26.400 FDHLS	294 kW		10/07→			
26.400 FDS, FDLS, FDRS, FDLRS	294 kW		07/08→			
26.400 FNHLC	294 kW		12/07→			
26.400 FNHLS	294 kW		12/07→			
26.400 FNLC, FNLRC, FNLLC, FNLLRC, FNLLW	294 kW		10/07→			
26.400 FNLS, FNLLS, FNLRS, FNLLRS, FPLS, FPLRS, FVLS	294 kW		10/07→			
26.400 FPHLS	294 kW		05/08→			
26.400 FVHLS	294 kW		05/08→			
26.440 FDC, FDLC, FDRC, FDLRC	324 kW		07/08→			
26.440 FDHLC	324 kW		09/07→			
26.440 FDHLS	324 kW		10/07→			
26.440 FDS, FDLS, FDRS, FDLRS	324 kW		07/08→			
26.440 FNHLC	324 kW		12/07→			
26.440 FNHLS	324 kW		12/07→			
26.440 FNLC, FNLRC, FNLLC, FNLLRC, FNLLW	324 kW		10/07→			
26.440 FNLS, FNLLS, FNLRS, FNLLRS, FPLS, FPLRS, FVLS	324 kW		10/07→			
26.440 FPHLS	324 kW		05/08→			
26.440 FPLRS	324 kW		07/08→			
26.440 FVHLS	324 kW		05/08→			
26.480 FDC, FDLC, FDRC, FDLRC	353 kW		07/08→			
26.480 FDHLC	353 kW		09/07→			
26.480 FDHLS	353 kW		10/07→			
26.480 FDS, FDLS, FDRS, FDLRS	353 kW		07/08→			
26.480 FNHLC	353 kW		12/07→			
26.480 FNHLS	353 kW		12/07→			
26.480 FNLC, FNLRC, FNLLC, FNLLRC, FNLLW	353 kW		10/07→			
26.480 FNLS, FNLLS, FNLRS, FNLLRS, FPLS, FPLRS, FVLS	353 kW		10/07→			
26.480 FPHLS	353 kW		05/08→			
26.480 FVHLS	353 kW		05/08→			
26.540 FDC, FDLC, FDRC, FDLRC	397 kW		02/09→			
26.540 FDS, FDLS, FDRS, FDLRS	397 kW		02/09→			
26.540 FNLC, FNLRC, FNLLC, FNLLRC, FNLLW	397 kW		10/07→			
26.540 FNLS, FNLRS, FNLLS, FPLS, FPLRS, FVLS	397 kW		10/07→			
28.360 FNLC	265 kW		10/07→			
28.360 FNLS	265 kW		10/07→			
28.400 FNLC	294 kW		10/07→			
28.400 FNLS	294 kW		10/07→			
28.440 FNLC	324 kW		10/07→			
28.440 FNLS	324 kW		10/07→			
28.480 FNLC	353 kW		10/07→			
28.480 FNLS	353 kW		10/07→			
28.540 FNLC	397 kW		10/07→			

Manufacturer - Model	Power	Displ.	Year of Constr.	Remark	Part Number	Page	
MAN - TGX						09/07→	
28.540 FNLS	397 kW		02/09→	Front; L 700 mm; Quantity: 1	9XW 184 107-281 Wiper 112 Blade		
33.360 FDC, FDC/M, FDLC	265 kW		10/07→				
33.360 FDS, FDS/M, FDLS, FDLS/M	265 kW		10/07→	Front; Length [in]: 28; L 700 mm; Quantity: 1	9XW 191 397-281 Wiper 115 Blade		
33.400 FDC, FDC/M, FDLC	294 kW		10/07→				
33.400 FDS, FDS/M, FDLS, FDLS/M	294 kW		10/07→				
33.440 FDC, FDC/M, FDLC	324 kW		10/07→				
33.440 FDS, FDS/M, FDLS, FDLS/M	324 kW		10/07→				
33.480 FDC, FDC/M, FDLC	353 kW		10/07→				
33.480 FDS, FDS/M, FDLS, FDLS/M	353 kW		10/07→				
33.540 FDC, FDC/M, FDLC	397 kW		10/07→				
33.540 FDS, FDS/M, FDLS, FDLS/M	397 kW		10/07→				
33.680 FDLC	500 kW		10/07→				
33.680 FDLS	500 kW		10/07→				
35.360 FDNLC	265 kW		06/08→				
35.400 FDNLC	294 kW		06/08→				
35.440 FDNLC	324 kW		06/08→				
35.480 FDNLC	353 kW		06/08→				
35.540 FDNLC	397 kW		06/08→				
41.540 FVDS, FVDLS	397 kW		06/08→				
41.680 FVDS, FVDLS	500 kW		10/07→				
MAN - ÜL						09/89→	
ÜL 242	177 kW		09/89→03/93	Front; L 1,000 mm; Quantity: 1	9XW 184 107-401 Wiper 113 Blade		
ÜL 272	198 kW		03/93→				
ÜL 292	213 - 222 kW		09/89→03/93	Front; Length [in]: 40; L 1,000 mm; Quantity: 1	9XW 191 397-401 Wiper 116 Blade		
ÜL 312, ÜL 322	228 - 235 kW		04/92→09/96				
				Front; Length [in]: 40; L 1,000 mm; Quantity: 1	9XW 194 562-401 Wiper 117 Blade		

AUWÄRTER	HELLA
11027014	8TW 004 764-041
1507.329.00	8TW 004 764-041
DAF	HELLA
038 4984	8TW 004 764-041
938 4984	8TW 004 764-041
ERF	HELLA
81.26485.6029	8TW 007 540-037
EVOBUS	HELLA
000 860 47 26	8TW 007 540-037
000 860 54 26	8TW 004 764-041
FAUN	HELLA
7000-459	8TW 004 764-041
FIAT	HELLA
4776226	8TW 004 764-041
FORD	HELLA
6 162 673	8TW 004 764-041
IVECO	HELLA
0477 6226	8TW 004 764-041
5000 953754	8TW 004 764-041
9384 984	8TW 004 764-041
MAN	HELLA
81.26485.6029	8TW 007 540-037
81.77630.0093	8TW 004 764-041
88.26485.6005	8TW 004 764-041
MERCEDES-	
BENZ	HELLA
000 860 14 26	8TW 004 764-041
000 860 23 26	8TW 004 764-041
000 860 47 26	8TW 007 540-037
000 869 40 21	8TW 006 849-091
A 000 860 14 26	8TW 004 764-041
A 000 860 23 26	8TW 004 764-041
A 000 860 47 26	8TW 007 540-037
A 000 869 40 21	8TW 006 849-091
NEOPLAN	HELLA
81.77630-0093	8TW 004 764-041
RENAULT	HELLA
50 00 953 754	8TW 004 764-041
SAAB	HELLA
04 10 861	8TW 004 764-041
SCANIA	HELLA
410 861	8TW 004 764-041
SISU	HELLA
112-210-0081	8TW 004 764-041
VOLVO	HELLA
2 050 485 7	8TW 004 764-041
VOE4823997	8TW 004 764-041



8TW ...

8TW 004 764-041	110
8TW 006 849-091	111
8TW 007 540-037	110

9XW ...

9XW 184 107-201	112
9XW 184 107-241	112
9XW 184 107-281	112
9XW 184 107-321	113
9XW 184 107-361	113
9XW 184 107-401	113
9XW 191 397-201	114
9XW 191 397-241	114
9XW 191 397-281	115
9XW 191 397-321	115
9XW 191 397-361	116
9XW 191 397-401	116
9XW 194 562-361	117
9XW 194 562-401	117
9XW 862 050-001	118
9XW 862 052-001	118
9XW 862 056-001	119
9XW 862 061-001	119

Connecting Cable, outside mirror.....	179
Cover, outside mirror.....	178
Cover, wide angle mirror.....	178
Holder, outside mirror.....	180
Mirror Glass, outside mirror.....	183
Mirror Glass, ramp mirror.....	188
Mirror Glass, wide angle mirror.....	189
Outside Mirror.....	166
Ramp Mirror.....	181
Wide-angle mirror.....	182

Mirror - Outside Mirror

8SB 354 504-021
E1 0646

electrically adjustable, heated, 24V, right (RH traffic) _



Camber Radius	2,000
Fitting Position	Right
for mirror pole Ø [mm]	28
Height [mm]	399
Housing Colour	Black
Housing Type	Synthetic Material Housing
Inspection Tag	E1 0646
Operating Mode	Electric
Outer/Inner Mirror	<ul style="list-style-type: none"> • Heatable • for electric mirror adjustment
Rated Voltage [V]	24
Width [mm]	222

Spare Parts

	1 x 9HB 863 836-001 Cover, outside mirror
	1 x 9MX 564 249-001 Mirror Glass, outside mirror
	1 x 9MX 863 838-001 Mirror Glass, outside mirror

8SB 501 137-001
E1 12006



Camber Radius	450
Fitting Position	Right
Height [mm]	155
Housing Colour	Black
Housing Type	Synthetic Material Housing
Inspection Tag	E1 12006
Supplementary Article/Supplementary Info	without holder
Width [mm]	245

Mirror - Outside Mirror

8SB 501 137-031
e1 12006, 089097

Safety manoeuvre mirror



Camber Radius	450
Fitting Position	Right
Height [mm]	155
Housing Colour	Black
Inspection Tag	e1 12006
Supplementary Article/Supplementary Info	with holder
Width [mm]	245

Spare Parts

1 x 8SB 501 137-001 Outside Mirror



8SB 501 156-021
089061, E1 14087

HELLA



Camber Radius	2,200
Fitting Position	<ul style="list-style-type: none"> • Left • Right
for mirror pole Ø [mm]	<ul style="list-style-type: none"> • 15 • 20
Height [mm]	375
Housing Colour	Black
Housing Type	Synthetic Material Housing
Inspection Tag	E1 14087
Mounting Type	Bolted
Outer/Inner Mirror	form manual mirror adjustment
Overall Height [mm]	168
Width [mm]	186

Spare Parts

1 x 9EY 120 010-001 Mirror Glass



Mirror - Outside Mirror

8SB 501 156-031
089119, E1 14087

heated, 24V _



Camber Radius	2,200
Fitting Position	<ul style="list-style-type: none"> • Left • Right
for mirror pole Ø [mm]	<ul style="list-style-type: none"> • 15 • 20
Height [mm]	375
Housing Colour	Black
Housing Type	Synthetic Material Housing
Inspection Tag	E1 14087
Mounting Type	Bolted
Outer/Inner Mirror	<ul style="list-style-type: none"> • Heatable • form manual mirror adjustment
Overall Height [mm]	168
Rated Voltage [V]	24
Width [mm]	186

Spare Parts



1 x 9MX 561 891-001 Mirror Glass, outside mirror

Accessories

1 x 8KA 500 218-002 Connecting Cable, outside mirror

Mirror - Outside Mirror

8SB 501 246-812

e1 0062, E1 0370, E1 0944, e1 0369

heated, 24V, right _



Camber Radius	2,100
Fastening Type	Dove tail fitting
Fitting Position	Right
Height [mm]	551
Housing Colour	Black
Housing Type	Synthetic Material Housing
Inspection Tag	<ul style="list-style-type: none"> • e1 0062 • e1 0369 • E1 0370 • E1 0944
Operating Mode	Electric
Outer/Inner Mirror	Heatable
Quantity per Packing Unit	1
Rated Voltage [V]	24
Supplementary Article/Supplementary Info 2	with tie rod
Width [mm]	661

Spare Parts

1 x 6GM 500 212-002 Switch
1 x 8HS 563 390-002 Mounting Kit, outside mirror
1 x 8JA 500 431-002 Plug
1 x 8KB 500 299-251 Cable Set, outside mirror
1 x 9BG 562 812-002 Housing
1 x 9BG 562 813-002 Housing
1 x 9BG 562 814-002 Housing
1 x 9BP 563 482-002 Holder, outside mirror
1 x 9GH 562 803-002 Bellow, mirror system
1 x 9HB 562 824-022 Cover, external mirror holder
1 x 9HD 562 802-012 Cover, outside mirror
1 x 9MX 562 841-002 Mirror Glass, outside mirror
1 x 9SV 562 840-003 Holder, outside mirror
1 x 9XD 562 800-052 Holder, outside mirror

Accessories

1 x 9BP 501 237-002 Baseplate, outside mirror
1 x 9BP 501 238-002 Baseplate, outside mirror
1 x 9BP 501 238-012 Baseplate, outside mirror
1 x 9BP 501 238-022 Baseplate, outside mirror
1 x 9BP 561 006-012 Baseplate, outside mirror
1 x 9BP 561 138-013 Baseplate, outside mirror
1 x 9BP 561 138-052 Baseplate, outside mirror
1 x 9XD 563 637-012 Holder, outside mirror



Mirror - Outside Mirror

8SB 501 246-892

E1 0370, e1 0062, E1 0944, E1 0369

with wide-angle and door observation mirror, heated, 24V, right



Camber Radius	<ul style="list-style-type: none"> • 2,100 • 240 • 450
Colour	Medium
Fastening Type	Dove tail fitting
Fitting Position	Right
Height [mm]	661
Housing Colour	Black
Housing Type	Synthetic Material Housing
Inspection Tag	<ul style="list-style-type: none"> • e1 0062 • E1 0369 • E1 0370 • E1 0944
Operating Mode	<ul style="list-style-type: none"> • Electric • Manual
Outer/Inner Mirror	<ul style="list-style-type: none"> • Heatable • with entry view mirror • with wide angle mirror
Quantity per Packing Unit	1
Rated Voltage [V]	24
Supplementary Article/Supplementary Info 2	with tie rod
Width [mm]	551

Spare Parts

- 1 x 6GM 500 212-002 Switch
- 1 x 8HS 563 390-002 Mounting Kit, outside mirror
- 1 x 8JA 500 431-002 Plug
- 1 x 8KB 500 299-251 Cable Set, outside mirror
- 1 x 8SB 501 346-032 Outside Mirror



- 1 x 9BG 562 812-002 Housing
- 1 x 9BG 562 813-002 Housing
- 1 x 9BG 562 814-002 Housing
- 1 x 9BP 563 482-002 Holder, outside mirror
- 1 x 9GH 562 803-002 Bellow, mirror system
- 1 x 9HB 562 824-022 Cover, external mirror holder
- 1 x 9HD 562 802-012 Cover, outside mirror
- 1 x 9MN 562 843-022 Control Element, outside mirror
- 1 x 9MX 562 841-002 Mirror Glass, outside mirror
- 1 x 9MX 562 846-002 Mirror Glass, outside mirror
- 1 x 9SV 562 829-002 Control Element, outside mirror
- 1 x 9SV 562 840-003 Holder, outside mirror
- 1 x 9XD 562 800-052 Holder, outside mirror
- 1 x 9XD 563 637-012 Holder, outside mirror



Accessories

- 1 x 9BP 501 237-002 Baseplate, outside mirror
- 1 x 9BP 501 238-002 Baseplate, outside mirror
- 1 x 9BP 501 238-012 Baseplate, outside mirror
- 1 x 9BP 501 238-022 Baseplate, outside mirror
- 1 x 9BP 561 006-012 Baseplate, outside mirror
- 1 x 9BP 561 138-013 Baseplate, outside mirror
- 1 x 9BP 561 138-052 Baseplate, outside mirror

Mirror - Outside Mirror

8SB 501 247-803

E1 0370, E1 0369, E1 0945, e1 0063

heated, 24V, upright, left



Camber Radius	2,100
Fastening Type	Dove tail fitting
Fitting Position	Left
Housing Colour	Black
Housing Type	Synthetic Material Housing
Inspection Tag	<ul style="list-style-type: none"> • e1 0063 • E1 0369 • E1 0370 • E1 0945
Mounting Type	External
Operating Mode	Electric
Outer/Inner Mirror	Heatable
Quantity per Packing Unit	1
Rated Voltage [V]	24

Spare Parts

1 x 6GM 500 212-002 Switch
1 x 8HG 562 851-002 Holder, outside mirror
1 x 8JA 500 431-002 Plug
1 x 9BG 562 812-002 Housing
1 x 9BG 562 813-002 Housing
1 x 9BG 562 814-002 Housing
1 x 9GH 562 803-002 Bellow, mirror system
1 x 9HB 562 837-022 Cover, external mirror holder
1 x 9HD 562 802-012 Cover, outside mirror
1 x 9MN 562 843-011 Control Element, outside mirror
1 x 9MX 562 841-002 Mirror Glass, outside mirror
1 x 9SV 562 829-002 Control Element, outside mirror
1 x 9SV 562 840-003 Holder, outside mirror

Accessories

1 x 9BP 501 237-002 Baseplate, outside mirror
1 x 9BP 501 238-002 Baseplate, outside mirror
1 x 9BP 501 238-012 Baseplate, outside mirror
1 x 9BP 501 238-022 Baseplate, outside mirror
1 x 9BP 561 006-012 Baseplate, outside mirror
1 x 9BP 561 138-013 Baseplate, outside mirror
1 x 9BP 561 138-052 Baseplate, outside mirror

Mirror - Outside Mirror



8SB 501 325-002
e1 0529, E1 0472

electrically adjustable, heated, 24V _



adjustable	Adjustable
Camber Radius	2,100
Fitting Position	<ul style="list-style-type: none"> • Left • Right
for mirror pole Ø [mm]	22
Height [mm]	383
Housing Colour	Black
Housing Type	Synthetic Material Housing
Inspection Tag	<ul style="list-style-type: none"> • E1 0472 • e1 0529
Operating Mode	Electric
Outer/Inner Mirror	<ul style="list-style-type: none"> • Heatable • for electric mirror adjustment
Rated Voltage [V]	24
Width [mm]	206

Spare Parts

	1 x 9HD 563 475-041 Cover, outside mirror
	1 x 9MX 563 468-002 Mirror Glass, outside mirror

Accessories

1 x 8HG 503 009-022 Holder, outside mirror
1 x 8HG 503 009-082 Holder, outside mirror
1 x 8HG 503 019-012 Holder, outside mirror
1 x 8HG 503 019-022 Holder, outside mirror

Mirror - Outside Mirror

8SB 501 325-012
089116, e1 0472, e1 0529

manually adjustable, heated, 24V _



adjustable	Adjustable
Camber Radius	2,100
Fitting Position	<ul style="list-style-type: none"> • Left • Right
for mirror pole Ø [mm]	22
Height [mm]	383
Housing Colour	Black
Housing Type	Synthetic Material Housing
Inspection Tag	<ul style="list-style-type: none"> • e1 0472 • e1 0529
Outer/Inner Mirror	<ul style="list-style-type: none"> • Heatable • form manual mirror adjustment
Rated Voltage [V]	24
Width [mm]	206

Spare Parts



1 x 9HD 563 475-041 Cover, outside mirror



1 x 9MX 563 468-002 Mirror Glass, outside mirror

Accessories

1 x 8HG 503 009-022 Holder, outside mirror

1 x 8HG 503 009-082 Holder, outside mirror

1 x 8HG 503 019-012 Holder, outside mirror

1 x 8HG 503 019-022 Holder, outside mirror

Mirror - Outside Mirror

8SB 501 325-032
E1 0472, e1 0529

electrically adjustable, heated, 12V _



Camber Radius	2,100
Fitting Position	<ul style="list-style-type: none"> • Left • Right
for mirror pole Ø [mm]	22
Height [mm]	383
Housing Colour	Black
Housing Type	Synthetic Material Housing
Inspection Tag	<ul style="list-style-type: none"> • E1 0472 • e1 0529
Operating Mode	Electric
Outer/Inner Mirror	<ul style="list-style-type: none"> • Heatable • for electric mirror adjustment
Rated Voltage [V]	12
Width [mm]	206

Spare Parts



1 x 9HD 563 475-041 Cover, outside mirror

Accessories

1 x 8HG 503 009-022 Holder, outside mirror
 1 x 8HG 503 009-082 Holder, outside mirror
 1 x 8HG 503 019-012 Holder, outside mirror
 1 x 8HG 503 019-022 Holder, outside mirror

Mirror - Outside Mirror

8SB 560 991-012

E1 14075, e1 0135, 089036, E1 0957, e1 14047

HELLA



Fitting Position	<ul style="list-style-type: none"> • Left • Right
Height [mm]	320
Housing Colour	Black
Housing Type	Synthetic Material Housing
Inspection Tag	<ul style="list-style-type: none"> • e1 0135 • E1 0957 • e1 14047 • E1 14075
Outer/Inner Mirror	Unheated
Width [mm]	186

Spare Parts



1 x 9EY 561 042-002 Mirror Glass

Mirror - Outside Mirror

8SB 560 991-041

e1 14047, E1 0957, E1 14075, e1 0135

heated, 24V _



Camber Radius	2,200
Fitting Position	<ul style="list-style-type: none"> • Left • Right
for mirror pole Ø [mm]	<ul style="list-style-type: none"> • 16 • 18
Height [mm]	320
Housing Colour	Black
Housing Type	Synthetic Material Housing
Inspection Tag	<ul style="list-style-type: none"> • e1 0135 • E1 0957 • e1 14047 • E1 14075
Outer/Inner Mirror	Heatable
Rated Voltage [V]	24
Width [mm]	186

Spare Parts



1 x 9MX 561 044-002 Mirror Glass, outside mirror

Accessories

1 x 8KA 560 271-002 Connecting Cable, outside mirror

Mirror - Outside Mirror

8SB 560 991-061

E1 0957, e1 14047, e1 0135, E1 14075



Fitting Position	<ul style="list-style-type: none"> • Left • Right
for mirror pole Ø [mm]	18
Height [mm]	320
Housing Colour	Black
Housing Type	Synthetic Material Housing
Inspection Tag	<ul style="list-style-type: none"> • e1 0135 • E1 0957 • e1 14047 • E1 14075
Width [mm]	<ul style="list-style-type: none"> • 186 • 22

Spare Parts



1 x 9EY 561 042-002 Mirror Glass

Cover, outside mirror

9HB 863 835-001

Fitting Position	Left
Left-hand / Right-hand Traffic	for right-hand traffic

9HD 563 475-041



Cover, wide angle mirror

9HB 863 839-001



Fitting Position	Left
------------------	------

9HB 863 840-001

Fitting Position	Right
------------------	-------

Electric Cable - Connecting Cable, outside mirror

8KA 500 218-002

Length [m]	1.5
Length [mm]	1,150
Plug Type ID	2-polig
Supplementary Article/Supplementary Info 2	with oval angled plug

8KA 560 271-002

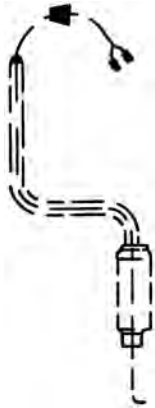

Length [mm]	2,000
Number of Poles	2
Supplementary Article/Supplementary Info 2	with a plug

Holder, outside mirror

8HG 503 009-022

Mirror arm, left, with 6-pin round-plug

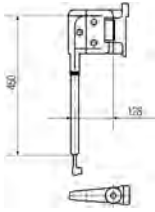

Fitting Position	Left
Height [mm]	450
Number of Poles	6
Operating Mode	Electric
Plug Type ID	6-polig
Width [mm]	128

8HG 503 009-082

Mirror arm, right, with 6-pin round-plug, without intermediate plate

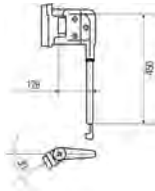

Fitting Position	Right
Height [mm]	450
Number of Poles	6
Operating Mode	Electric
Plug Type ID	6-polig
Supplementary Article/Supplementary Info	without roof rails
Width [mm]	128

8HG 503 019-012

Mirror arm, right, with 2-pin round-plug



Fitting Position	Right
Height [mm]	345
Number of Poles	2
Operating Mode	Electric
Plug Type ID	2-polig
Width [mm]	688

Holder, outside mirror

8HG 503 019-022

Mirror arm, right, with 6-pin round-plug



Fitting Position	Right
Height [mm]	345
Number of Poles	6
Operating Mode	Electric
Plug Type ID	6-polig
Width [mm]	688

Mirror - Ramp Mirror

8SB 354 509-001
E1 12015

Ramp mirror, electrically adjustable, heated, 24V



Camber Radius	450
Driver Position	for left-hand drive vehicles
Fitting Position	Right
Height [mm]	324
Housing Colour	Black
Housing Type	Synthetic Material Housing
Inspection Tag	E1 12015
Operating Mode	Electric
Outer/Inner Mirror	<ul style="list-style-type: none"> • Heatable • for electric mirror adjustment
Rated Voltage [V]	24
Width [mm]	185

Spare Parts

	1 x 9MX 863 847-011 Mirror Glass, ramp mirror
---	---

Mirror - Wide-angle mirror

8SB 501 147-021
089060, E1 11004, E1 11007

Wide-angle mirror for mirror arms \varnothing 16 - 22 mm _



Camber Radius	450
Fitting Position	<ul style="list-style-type: none"> • Left • Right
for mirror pole \varnothing [mm]	<ul style="list-style-type: none"> • 16 • 22
Height [mm]	161
Housing Colour	Black
Housing Type	Synthetic Material Housing
Inspection Tag	<ul style="list-style-type: none"> • E1 11004 • E1 11007
Mounting Type	Bolted
Outer/Inner Mirror	Unheated
Width [mm]	211

Spare Parts

 1 x 9EY 561 814-001 Mirror Glass

8SB 501 147-031
089121, E1 11004, e1 11007

Wide-angle mirror, heated, 24V, for mirror arms \varnothing 16 - 22 mm _



Camber Radius	450
Fitting Position	<ul style="list-style-type: none"> • Left • Right
for mirror pole \varnothing [mm]	<ul style="list-style-type: none"> • 16 • 22
Height [mm]	161
Housing Colour	Black
Housing Type	Synthetic Material Housing
Inspection Tag	<ul style="list-style-type: none"> • E1 11004 • e1 11007
Mounting Type	Bolted
Outer/Inner Mirror	Heatable
Rated Voltage [V]	24
Width [mm]	211

Spare Parts

 1 x 9MX 561 890-001 Mirror Glass, wide angle mirror

Accessories

1 x 8KA 500 218-002 Connecting Cable, outside mirror

Mirror Glass, outside mirror

9EY 120 010-001

e1 02*14087, e1 01*14019, E1 01 14087

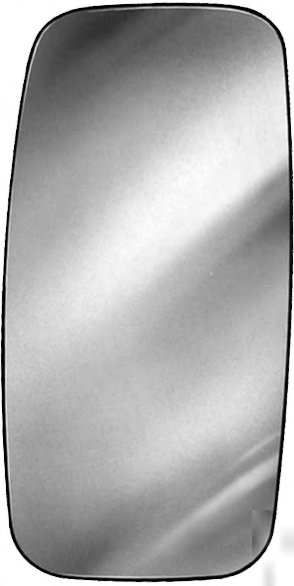

Camber Radius	2,200
Height [mm]	364
Inspection Tag	<ul style="list-style-type: none"> • E1 01 14087 • e1 01*14019 • e1 02*14087
Width [mm]	175

9EY 561 042-002

E1 01 14090, e1 02*14090



Camber Radius	2,200
Height [mm]	312
Inspection Tag	<ul style="list-style-type: none"> • E1 01 14090 • e1 02*14090
Width [mm]	180

Mirror Glass, outside mirror

9MX 561 044-002
E1 01 14090, e1 02*14090



Camber Radius	2,200
Height [mm]	312
Inspection Tag	<ul style="list-style-type: none"> • E1 01 14090 • e1 02*14090
Outer/Inner Mirror	Heatable
Rated Voltage [V]	24
Width [mm]	180

9MX 561 891-001
E1 01 14087, e1 02*14087



Camber Radius	2,200
Height [mm]	364
Inspection Tag	<ul style="list-style-type: none"> • E1 01 14087 • e1 02*14087
Outer/Inner Mirror	Heatable
Rated Voltage [V]	24
Width [mm]	175

Mirror Glass, outside mirror

9MX 563 468-002
E1 01 0472, e1 02*0472



Camber Radius	2,100
Height [mm]	371
Inspection Tag	<ul style="list-style-type: none"> • E1 01 0472 • e1 02*0472
Outer/Inner Mirror	Heatable
Rated Voltage [V]	24
Width [mm]	197

Mirror Glass, outside mirror

9MX 564 249-001

For converting the external mirrors 8SB 354 504-011/-021



Camber Radius	1,200
Fitting Position	<ul style="list-style-type: none"> • Left • Right
Fulfils ECE norm.	<ul style="list-style-type: none"> • 2003/38 • 2003/97
Height [mm]	379
Inspection Tag	II e1 03*0024
Outer/Inner Mirror	<ul style="list-style-type: none"> • Heatable • for electric mirror adjustment
Rated Voltage [V]	24
Width [mm]	176

Mirror Glass, outside mirror

9MX 863 838-001

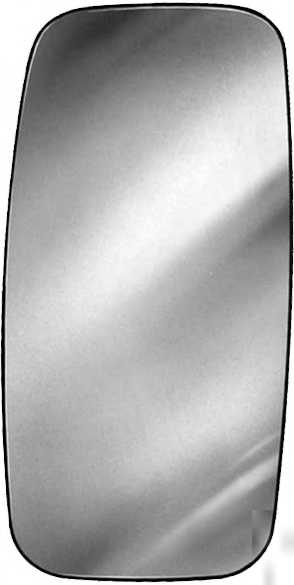

Camber Radius	2,000
Fitting Position	Right
Height [mm]	379
Inspection Tag	<ul style="list-style-type: none"> • II E1 010646 • II e1 02*0646
Outer/Inner Mirror	<ul style="list-style-type: none"> • Heatable • for electric mirror adjustment
Rated Voltage [V]	24
Width [mm]	176

Mirror Glass, ramp mirror

9MX 863 847-011

For converting the ramp mirror 8SB 354 509-001



Camber Radius	300
Fulfils ECE norm.	<ul style="list-style-type: none"> • 2003/38 • 2003/97
Height [mm]	324
Inspection Tag	V e1 03*0015
Outer/Inner Mirror	<ul style="list-style-type: none"> • Heatable • for electric mirror adjustment
Rated Voltage [V]	24
Width [mm]	185

Mirror Glass, wide angle mirror

9EY 561 814-001

E1 01 11007, e1 02*11004, e1 02*11007



Camber Radius	450
Height [mm]	150
Inspection Tag	<ul style="list-style-type: none"> • E1 01 11007 • e1 02*11004 • e1 02*11007
Width [mm]	200

9MX 561 890-001

E1 01 11007, e1 02*11007



Camber Radius	450
Height [mm]	150
Inspection Tag	<ul style="list-style-type: none"> • E1 01 11007 • e1 02*11007
Outer/Inner Mirror	Heatable
Rated Voltage [V]	24
Width [mm]	200

Mirror Glass, wide angle mirror

9MX 863 839-011

For converting the wide-angle mirrors 8SB 354 505-011/-021



Camber Radius	300
Fulfils ECE norm.	<ul style="list-style-type: none"> • 2003/38 • 2003/97
Height [mm]	177
Inspection Tag	IV e1 03*0025
Outer/Inner Mirror	<ul style="list-style-type: none"> • Heatable • for electric mirror adjustment
Rated Voltage [V]	24
Width [mm]	167



MAN.....192

Manufacturer - Model	Power	Displ.	Year of Constr.	Remark	Part Number	Page
MAN - Cab-over Trucks						07/86→05/94
19.322 U, 19.322 UL, 19.322 ULL	235 kW		02/90→05/94	with oval angled plug	8KA 500 218-002	179
19.332 U, 19.322 UL, 19.322 ULL	243 kW		07/86→02/90		Connecting Cable, outside mirror	
19.362 U, 19.362 UL, 19.362 ULL	265 kW		07/86→01/91			
19.372 U, 19.372 ULL	272 kW		02/90→05/94	Right; H 155 mm; without holder; W 245 mm	8SB 501 137-001	166
19.422 U, 19.422 ULL	309 kW		02/90→05/94		Outside Mirror	
24.322 UNL, 24.322 UNLL	235 kW		02/90→12/90	Right; H 155 mm; with holder; W 245 mm	8SB 501 137-031	167
24.332 UNL, 24.332 UNLL	243 kW		10/86→02/90		Outside Mirror	
24.362 UNL, 24.362 UNLL	265 kW		10/86→02/90			
24.372 UNL, 24.372 UNLL	272 kW		02/90→12/90	Left / Right; H 161 mm; Unheated; W 211 mm	8SB 501 147-021	182
24.422 UNL, 24.422 UNLL	309 kW		02/90→12/90		Wide-angle mirror	
25.322 UNL, 25.322 UNLL	235 kW		09/90→12/92	Left / Right; H 161 mm; Heatable; 24 V; W 211 mm	8SB 501 147-031	182
25.372 UNL, 25.372 UNLL	272 kW		09/90→12/92		Wide-angle mirror	
25.422 UNL, 25.422 UNLL	309 kW		09/90→12/92	Left / Right; H 375 mm; form manual mirror adjustment; + H 168 mm; W 186 mm	8SB 501 156-021	167
26.322 UNL, 26.322 UNLL	235 kW		09/90→05/94		Outside Mirror	
26.372 UNL, 26.372 UNLL	272 kW		09/90→05/94	Left / Right; H 375 mm; Heatable / form manual mirror adjustment; + H 168 mm; 24 V; W 186 mm	8SB 501 156-031	168
26.422 UNL, 26.422 UNLL	309 kW		09/90→05/94		Outside Mirror	
					9EY 120 010-001	183
					Glass, outside mirror	
					9EY 561 814-001	189
					Glass, wide angle mirror	
				Heatable; 24 V	9MX 561 890-001	189
					Glass, wide angle mirror	
				Heatable; 24 V	9MX 561 891-001	184
					Glass, outside mirror	
MAN - F 90						07/86→
15.192 FL	141 kW			with oval angled plug	8KA 500 218-002	179
19.242 F, 19.242 FL, 19.242 FLL	177 kW		01/88→01/89		Connecting Cable, outside mirror	
19.242 FK	177 kW		01/88→02/89			
19.242 FS, 19.242 FLS, 19.242 FLLS	177 kW		01/88→01/89	Right; H 155 mm; without holder; W 245 mm	8SB 501 137-001	166
19.262 F, 19.262 FL, 19.262 FLL	191 kW		01/88→02/90		Outside Mirror	
19.262 FA	191 kW		02/89→02/90	Right; H 155 mm; with holder; W 245 mm	8SB 501 137-031	167
19.262 FAK	191 kW		02/89→02/90		Outside Mirror	
19.262 FAS	191 kW		02/89→02/90	Left / Right; H 161 mm; Unheated; W 211 mm	8SB 501 147-021	182
19.262 FK	191 kW		01/88→02/90		Wide-angle mirror	
19.262 FS, 19.262 FLS, 19.262 FLLS	191 kW		01/88→02/90	Left / Right; H 161 mm; Heatable; 24 V; W 211 mm	8SB 501 147-031	182
19.272 F, 19.272 FL, 19.272 FLL	198 kW		02/90→05/95		Wide-angle mirror	
19.272 FA	198 kW		02/90→05/95	Left / Right; H 375 mm; form manual mirror adjustment; + H 168 mm; W 186 mm	8SB 501 156-021	167
19.272 FAK	198 kW		02/90→05/95		Outside Mirror	
19.272 FAS	198 kW		02/90→05/95	Left / Right; H 375 mm; Heatable / form manual mirror adjustment; + H 168 mm; 24 V; W 186 mm	8SB 501 156-031	168
19.272 FK	198 kW		02/90→05/95		Outside Mirror	
19.272 FS, 19.272 FLS, 19.272 FLLS	198 kW		02/90→05/95			
19.292 F, 19.292 FL, 19.292 FLL	213 kW		07/86→02/90		9EY 120 010-001	183
19.292 FA	213 kW		05/88→02/90		Glass, outside mirror	
19.292 FAK	213 kW		05/88→02/90		9EY 561 814-001	189
19.292 FAS	213 kW		05/88→02/90		Glass, wide angle mirror	
19.292 FK	213 kW		07/86→02/90	Heatable; 24 V	9MX 561 890-001	189
19.292 FS, 19.292 FLS, 19.292 FLLS	213 kW		07/86→02/90		Glass, wide angle mirror	
19.322 F, 19.322 FL, 19.322 FLL	235 kW		02/90→05/95		9MX 561 891-001	184
19.322 FA	235 kW		02/90→06/96	Heatable; 24 V	Glass, outside mirror	
19.322 FAK	235 kW		02/90→06/96			
19.322 FAS	235 kW		02/90→06/96			
19.322 FK	235 kW		02/90→05/95			
19.322 FS, 19.322 FLS, 19.322 FLLS	235 kW		02/90→05/95			
19.332 F, 19.332 FL, 19.332 FLL	243 kW		07/86→02/90			
19.332 FA	243 kW		05/88→02/90			
19.332 FAK	243 kW		05/88→02/90			
19.332 FAS	243 kW		05/88→02/90			
19.332 FK	243 kW		07/86→02/90			
19.332 FS, 19.332 FLS, 19.332 FLLS	243 kW		07/86→02/90			
19.342 F, 19.342 FL, 19.342 FLL	250 kW		05/94→05/95			
19.342 FA	250 kW		05/94→06/96			
19.342 FAK	250 kW		05/94→06/96			
19.342 FAS	250 kW		05/94→06/96			
19.342 FK	250 kW		05/94→05/95			
19.342 FS, 19.342 FLS, 19.342 FLLS	250 kW		05/94→05/95			
19.362 F, 19.362 FL, 19.362 FLL	265 kW		07/86→02/90			
19.362 FA	265 kW		05/88→02/90			
19.362 FAK	265 kW		05/88→02/90			
19.362 FAS	265 kW		05/88→02/90			
19.362 FK	265 kW		07/86→02/90			

Manufacturer - Model	Power	Displ.	Year of Constr.	Remark	Part Number	Page
MAN - F 90						07/86→
19.362 FS,19.362 FLS,19.362 FLLS	265 kW		07/86→02/90	with oval angled plug	8KA 500 218-002 Connecting Cable, outside mirror	179
19.372 F,19.372 FL,19.372 FLL	249 kW		05/90→04/95			
19.372 F,19.372 FL,19.372 FLL	272 kW		02/90→05/95	Right; H 155 mm; without holder; W 245 mm	8SB 501 137-001 Outside Mirror	166
19.372 FA	272 kW		02/90→06/96			
19.372 FAK	272 kW		02/90→06/96	Right; H 155 mm; with holder; W 245 mm	8SB 501 137-031 Outside Mirror	167
19.372 FAS	272 kW		02/90→06/96			
19.372 FK	249 kW		05/90→04/95			
19.372 FK	272 kW		02/90→05/95	Left / Right; H 161 mm; Unheated; W 211 mm	8SB 501 147-021 Wide- angle mirror	182
19.372 FS,19.372 FLS,19.372 FLLS	249 kW		05/90→04/95			
19.372 FS,19.372 FLS,19.372 FLLS	272 kW		02/90→05/95	Left / Right; H 161 mm; Heatable; 24 V; W 211 mm	8SB 501 147-031 Wide- angle mirror	182
19.402 F,19.402 FL,19.402 FLL	294 kW		05/94→05/95	Left / Right; H 375 mm; form manual mirror adjustment; + H 168 mm; W 186 mm	8SB 501 156-021 Outside Mirror	167
19.402 FA	294 kW		05/94→06/96			
19.402 FAK	294 kW		05/94→06/96	Left / Right; H 375 mm; Heatable / form manual mirror adjustment; + H 168 mm; 24 V; W 186 mm	8SB 501 156-031 Outside Mirror	168
19.402 FAS	294 kW		05/94→06/96			
19.402 FK	294 kW		05/94→05/95			
19.402 FS,19.402 FLS,19.402 FLLS	294 kW		05/94→05/95		9EY 120 010-001 Mirror Glass, outside mirror	183
19.422 F,19.422 FL,19.422 FLL	309 kW		02/90→05/95		9EY 561 814-001 Mirror Glass, wide angle mirror	189
19.422 FA	309 kW		02/90→06/96			
19.422 FAK	309 kW		02/90→06/96	Heatable; 24 V	9MX 561 890-001 Mirror Glass, wide angle mirror	189
19.422 FAS	309 kW		02/90→06/96			
19.422 FK	309 kW		02/90→05/95	Heatable; 24 V	9MX 561 891-001 Mirror Glass, outside mirror	184
19.422 FS,19.422 FLS,19.422 FLLS	309 kW		02/90→05/95			
19.462 F,19.462 FL	338 kW		05/87→02/90			
19.462 FK	338 kW		05/87→02/90			
19.462 FS,19.462 FLS	338 kW		05/87→02/90			
19.502 F,19.502 FL,19.502 FLL	368 kW		02/90→06/96			
19.502 FS,19.502 FLS,19.502 FLLS	368 kW		02/90→06/96			
24.242 DF	177 kW		01/88→07/89			
24.242 DFK	177 kW		01/88→07/89			
24.242 DFS	177 kW		01/88→07/89			
24.242 FNL,24.242 FNLL,24.242 FVL	177 kW		01/88→02/90			
24.262 DF	191 kW		01/88→02/90			
24.262 DFK	191 kW		01/88→02/90			
24.262 DFS,24.262 DFLS	191 kW		01/88→02/90			
24.262 FNL,24.262 FNLL,24.262 FVL	191 kW		01/88→02/90			
24.272 DF	198 kW		02/90→12/90			
24.272 DFK	198 kW		02/90→12/90			
24.272 DFS,24.272 DFLS	198 kW		02/90→04/95			
24.272 FNL,24.272 FNLL,24.272 FVL	198 kW		02/90→05/95			
24.272 FNLS,24.272 FVLS	198 kW		02/90→05/95			
24.292 DF	213 kW		04/87→02/90			
24.292 DFK	213 kW		04/87→02/90			
24.292 DFS,24.292 DFLS	213 kW		04/87→02/90			
24.292 FNL,24.292 FNLL,24.292 FVL	213 kW		10/86→02/90			
24.292 FNLS,24.292 FVLS	213 kW		10/86→02/90			
24.302 DF	220 kW		05/90→12/90			
24.302 DFK	220 kW		05/90→12/90			
24.302 DFS,24.302 DFLS	220 kW		05/90→04/95			
24.302 FNL,24.302 FNLL,24.302 FVL	220 kW		05/90→10/90			
24.322 DF	235 kW		02/90→12/90			
24.322 DFK	235 kW		02/90→12/90			
24.322 DFS,24.322 DFLS	235 kW		02/90→12/90			
24.322 FNL,24.322 FNLL,24.322 FVL	235 kW		02/90→05/95			
24.322 FNLS,24.322 FVLS	235 kW		02/90→05/95			
24.332 DF	243 kW		04/87→02/90			
24.332 DFK	243 kW		04/87→02/90			
24.332 DFS,24.332 DFLS	243 kW		04/87→02/90			
24.332 FNL,24.332 FNLL,24.332 FVL	243 kW		10/86→02/90			
24.332 FNLS,24.332 FVLS	243 kW		10/86→02/90			
24.342 FNL,24.342 FNLL	250 kW		05/94→05/95			
24.362 DF	265 kW		04/87→02/90			
24.362 DFK	265 kW		04/87→02/90			
24.362 DFS,24.362 DFLS	265 kW		04/87→02/90			
24.362 FNL,24.362 FNLL,24.362 FVL	265 kW		10/86→02/90			
24.362 FNLS,24.362 FVLS	265 kW		10/86→02/90			
24.372 DF	249 kW		05/90→12/90			
24.372 DF	272 kW		02/90→12/90			

Manufacturer - Model	Power	Displ.	Year of Constr.	Remark	Part Number	Page
MAN - F 90						07/86→
24.372 DFK	249 kW		05/90→12/90	with oval angled plug	8KA 500 218-002	179
24.372 DFK	272 kW		02/90→12/90		Connecting Cable,	
24.372 DFS	249 kW		05/90→12/90		outside mirror	
24.372 DFS, 24.372 DFLS	272 kW		02/90→04/95	Right; H 155 mm; without holder; W 245 mm	8SB 501 137-001	166
24.372 FNL,24.372 FNLL,24.372 FVL	272 kW		02/90→05/95		Outside Mirror	
24.372 FNLS,24.372 FVLS	272 kW		02/90→05/95	Right; H 155 mm; with holder; W 245 mm	8SB 501 137-031	167
24.372 FVL	249 kW		05/90→12/90		Outside Mirror	
24.372 FVLS	249 kW		05/90→12/90	Left / Right; H 161 mm; Unheated; W 211 mm	8SB 501 147-021	182
24.402 FNL,24.402 FNLL	294 kW		05/94→05/95		angle mirror	
24.422 DF	309 kW		02/90→12/90	Left / Right; H 161 mm; Heatable; 24 V; W 211 mm	8SB 501 147-031	182
24.422 DFK	309 kW		02/90→12/90		angle mirror	
24.422 DFS,24.422 DFLS	309 kW		02/90→12/90	Left / Right; H 375 mm; form manual mirror adjustment; + H 168 mm; W 186 mm	8SB 501 156-021	167
24.422 FNL,24.422 FNLL,24.422 FVL	309 kW		02/90→05/95		Outside Mirror	
24.462 DF	338 kW		02/89→02/90	Left / Right; H 375 mm; Heatable / form manual mirror adjustment; + H 168 mm; 24 V; W 186 mm	8SB 501 156-031	168
24.462 DFS	338 kW		02/89→02/90		Outside Mirror	
24.462 FNL	338 kW		04/89→02/90			
24.462 FVLS	338 kW		05/87→07/87		9EY 120 010-001	183
24.502 DF	368 kW		02/90→12/90		Glass, outside mirror	
24.502 DFK	368 kW		02/90→12/90		9EY 561 814-001	189
24.502 DFS	368 kW		02/90→12/90		Glass, wide angle mirror	
24.502 FNL	368 kW		02/90→12/90	Heatable; 24 V	9MX 561 890-001	189
25.272 DF	198 kW		09/90→12/92		Glass, wide angle mirror	
25.272 DFK	198 kW		09/90→12/92	Heatable; 24 V	9MX 561 891-001	184
25.272 DFS,25.272 DFLS	198 kW		09/90→12/92		Glass, outside mirror	
25.272 FNL,25.272 FNLL,25.272 FVL	198 kW		09/90→10/93			
25.302 DF	220 kW		09/90→12/91			
25.302 DFK	220 kW		09/90→12/91			
25.302 DFS, 25.302 DFLS	220 kW		09/90→12/91			
25.302 FNL, 25.302 FNLL, 25.302 FVL	220 kW		09/90→12/91			
25.302 FNLS, 25.302 FVLS	220 kW		09/90→12/91			
25.322 DF, 25.322 DFL	235 kW		09/90→12/92			
25.322 DFK	235 kW		09/90→12/92			
25.322 DFS, 25.322 DFLS	235 kW		09/90→12/92			
25.322 FNL, 25.322 FNLL, 25.322 FVL	235 kW		09/90→12/92			
25.322 FNLS,25.322 FVLS	235 kW		09/90→12/92			
25.372 DF	249 kW		09/90→12/92			
25.372 DFK	272 kW		09/90→12/92			
25.372 DFK	249 kW		09/90→12/92			
25.372 DFK	272 kW		09/90→12/92			
25.372 DFS	249 kW		09/90→12/92			
25.372 DFS,25.372 DFLS	272 kW		09/90→12/92			
25.372 FNL, 25.372 FNLL, 25.372 FVL	272 kW		09/90→12/92			
25.372 FNLS,25.372 FVLS	272 kW		09/90→10/93			
25.372 FVLS	249 kW		09/90→10/93			
25.422 DF	309 kW		09/90→12/92			
25.422 DFK	309 kW		09/90→12/92			
25.422 DFS,25.422 DFLS	309 kW		09/90→12/92			
25.422 FNL,25.422 FNLL	309 kW		09/90→12/92			
25.422 FNLS,25.422 FVLS	309 kW		09/90→12/92			
25.502 DF	368 kW		09/90→12/92			
25.502 DFS	368 kW		09/90→12/92			
25.502 FNL	368 kW		09/90→12/92			
26.242 DF	177 kW		01/88→07/89			
26.242 DFAK	177 kW		02/89→07/89			
26.242 DFK	177 kW		01/88→07/89			
26.242 DFS	177 kW		01/88→07/89			
26.262 DF	191 kW		01/88→02/90			
26.262 DFA	191 kW		02/89→02/90			
26.262 DFAK	191 kW		02/89→02/90			
26.262 DFAS	191 kW		02/89→02/90			
26.262 DFK	191 kW		01/88→02/90			
26.262 DFS	191 kW		01/88→02/90			
26.272 DF	198 kW		02/90→06/96			
26.272 DFA	198 kW		02/90→12/92			
26.272 DFAK	198 kW		02/90→12/92			
26.272 DFAS	198 kW		02/90→12/92			
26.272 DFK	198 kW		02/90→06/96			
26.272 DFS,26.272 DFLS	198 kW		02/90→06/96			
26.272 FNL,26.272 FNLL	198 kW		03/91→05/95			
26.272 FNLS,26.272 FVLS	198 kW		09/90→12/95			
26.292 DF, 26.292 DFL	213 kW		09/87→02/90			
26.292 DFA	213 kW		05/88→02/90			
26.292 DFAK	213 kW		05/88→02/90			
26.292 DFAS	213 kW		05/88→02/90			
26.292 DFK	213 kW		09/87→02/90			

Manufacturer - Model	Power	Displ.	Year of Constr.	Remark	Part Number	Page
MAN - F 90						07/86→
26.292 DFS	213 kW		09/87→02/90	with oval angled plug	8KA 500 218-002	179
26.302 DF	220 kW		05/90→12/91		Connecting Cable, outside mirror	
26.302 DFA	220 kW		05/90→12/91			
26.302 DFAK	220 kW		05/90→12/91	Right; H 155 mm; without holder; W 245 mm	8SB 501 137-001	166
26.302 DFAS	220 kW		05/90→12/91		Outside Mirror	
26.302 DFK	220 kW		05/90→12/91	Right; H 155 mm; with holder; W 245 mm	8SB 501 137-031	167
26.302 DFS	220 kW		05/90→12/91		Outside Mirror	
26.302 FNL, 26.302 FNLL, 26.302 FVL	220 kW		03/91→12/91			
26.302 FNLS,26.302 FVLS	220 kW		09/90→12/91	Left / Right; H 161 mm; Unheated; W 211 mm	8SB 501 147-021	182
26.322 DF	235 kW		02/90→06/96		angle mirror	
26.322 DFA	235 kW		02/90→12/92	Left / Right; H 161 mm; Heatable; 24 V; W 211 mm	8SB 501 147-031	182
26.322 DFAK	235 kW		02/90→12/92		angle mirror	
26.322 DFAS	235 kW		02/90→12/92	Left / Right; H 375 mm; form manual mirror adjustment; + H 168 mm; W 186 mm	8SB 501 156-021	167
26.322 DFK	235 kW		02/92→06/96		Outside Mirror	
26.322 DFS,26.322 DFLS	235 kW		02/90→06/96	Left / Right; H 375 mm; Heatable / form manual mirror adjustment; + H 168 mm; 24 V; W 186 mm	8SB 501 156-031	168
26.322 FNL,26.322 FNLL	235 kW		03/91→05/95		Outside Mirror	
26.322 FNLS,26.322 FVLS	235 kW		09/90→12/95			
26.332 DF, 26.332 DFL	243 kW		09/87→02/90		9EY 120 010-001	183
26.332 DFA	243 kW		05/88→02/90		Mirror Glass, outside mirror	
26.332 DFAK	243 kW		05/88→02/90			
26.332 DFAS	243 kW		05/88→02/90		9EY 561 814-001	189
26.332 DFK	243 kW		09/87→02/90	Heatable; 24 V	Mirror Glass, wide angle mirror	
26.332 DFS	243 kW		09/87→02/90			
26.342 DF,26.342 DFL	250 kW		05/94→06/96	Heatable; 24 V	9MX 561 890-001	189
26.342 DFK,26.342 DFLK	250 kW		05/94→06/96		Mirror Glass, wide angle mirror	
26.342 DFS	250 kW		04/94→06/96			
26.362 DF, 26.362 DFL	265 kW		09/87→02/90			
26.362 DFA	265 kW		05/88→02/90			
26.362 DFAK	265 kW		05/88→02/90			
26.362 DFAS	265 kW		05/88→02/90			
26.362 DFK	265 kW		09/87→02/90			
26.362 DFS	265 kW		09/87→02/90			
26.372 DF,26.372 DFL	272 kW		02/90→06/96			
26.372 DFA	272 kW		02/90→12/92			
26.372 DFAK	272 kW		01/92→06/96			
26.372 DFAS	272 kW		02/90→12/92			
26.372 DFK	272 kW		01/92→06/96			
26.372 DFS	272 kW		02/90→06/96			
26.372 FNL,26.372 FNLL,26.372 FVL	272 kW		09/90→12/95			
26.372 FNLS,26.372 FVLS	272 kW		01/92→06/96			
26.402 DF,26.402 DFL	294 kW		05/94→06/96			
26.402 DFK,26.402 DFLK	294 kW		05/94→06/96			
26.402 DFS	294 kW		05/94→12/95			
26.402 FNL,26.402 FNLL,26.402 FVL	294 kW		05/94→06/96			
26.402 FNLS,26.402 FVLS	294 kW		05/94→06/96			
26.422 DF,26.422 DFL	309 kW		02/90→06/96			
26.422 DFA	309 kW		02/90→12/92			
26.422 DFAK	309 kW		02/90→12/92			
26.422 DFAS	309 kW		02/90→12/92			
26.422 DFK	309 kW		02/90→12/95			
26.422 DFS	309 kW		02/90→12/95			
26.422 FNL,26.422 FNLL,26.422 FVL	309 kW		09/90→12/95			
26.422 FNLS,26.422 FVLS	309 kW		01/92→12/95			
26.462 DF	338 kW		02/89→02/90			
26.462 DFA	338 kW		08/89→02/90			
26.462 DFAS	338 kW		08/89→02/90			
26.462 DFS	338 kW		02/89→02/90			
26.502 DF	368 kW		02/90→06/96			
26.502 DFA	368 kW		02/90→12/92			
26.502 DFAS	368 kW		02/90→12/92			
26.502 DFS,26.502 DFLS	368 kW		02/90→06/96			
26.502 FNL,26.502 FNLL	368 kW		09/91→06/96			
32.262 VF	191 kW		02/89→02/90			
32.262 VFK	191 kW		02/89→02/90			
32.262 VFTM	191 kW		02/89→02/90			
32.272 VF	198 kW		02/90→04/95			
32.272 VFK	198 kW		02/90→04/95			
32.292 VF	213 kW		03/88→02/90			
32.292 VFK	213 kW		03/88→02/90			
32.302 VF	220 kW		05/90→09/91			
32.302 VFK	220 kW		05/90→09/91			
32.322 VF	235 kW		02/90→06/96			
32.322 VFK	235 kW		02/90→06/96			
32.332 VF	243 kW		03/88→02/90			
32.332 VFK	243 kW		03/88→02/90			
32.342 VFK	250 kW		05/94→06/96			
32.362 VF	265 kW		03/88→02/90			

Manufacturer - Model	Power	Displ.	Year of Constr.	Remark	Part Number	Page
MAN - F 90						07/86→
32.362 VFK	265 kW		03/88→02/90	with oval angled plug	8KA 500 218-002	179
32.372 VF	249 kW		02/90→06/96		Connecting Cable, outside mirror	
32.372 VF	272 kW		02/90→06/96			
32.372 VFK	249 kW		05/90→04/95	Right; H 155 mm; without holder; W 245 mm	8SB 501 137-001	166
32.372 VFK	272 kW		02/90→06/96		Outside Mirror	
32.402 VFK	294 kW		05/94→06/96	Right; H 155 mm; with holder; W 245 mm	8SB 501 137-031	167
32.422 VF	309 kW		02/90→06/96		Outside Mirror	
32.422 VFK	309 kW		02/90→06/96			
33.242 DFAK	177 kW		01/88→08/88	Left / Right; H 161 mm; Unheated; W 211 mm	8SB 501 147-021 Wide-	182
33.242 DFK	177 kW		01/88→08/88		angle mirror	
33.262 DF	191 kW		08/88→02/90	Left / Right; H 161 mm; Heatable; 24 V; W 211 mm	8SB 501 147-031 Wide-	182
33.262 DFA	191 kW		07/89→02/90		angle mirror	
33.262 DFAK	191 kW		07/89→02/90	Left / Right; H 375 mm; form manual mirror adjustment; + H 168 mm; W 186 mm	8SB 501 156-021	167
33.262 DFK	191 kW		08/88→02/90		Outside Mirror	
33.272 DF	198 kW		10/92→04/95	Left / Right; H 375 mm; Heatable / form manual mirror adjustment; + H 168 mm; 24 V; W 186 mm	8SB 501 156-031	168
33.272 DFA	198 kW		10/92→04/95		Outside Mirror	
33.272 FVL	191 - 198 kW		10/92→04/95			
33.292 DF	213 kW		09/87→02/90		9EY 120 010-001 Mirror	183
33.292 DFA	213 kW		05/88→02/90		Glass, outside mirror	
33.292 DFAK	213 kW		05/88→02/90		9EY 561 814-001 Mirror	189
33.292 DFAS	213 kW		05/88→02/90		Glass, wide angle mirror	
33.292 DFK	213 kW		09/87→02/90	Heatable; 24 V	9MX 561 890-001 Mirror	189
33.292 DFS	213 kW		09/87→02/90		Glass, wide angle mirror	
33.322 DF	235 kW		09/91→06/96	Heatable; 24 V	9MX 561 891-001 Mirror	184
33.322 DFA	235 kW		09/91→06/96		Glass, outside mirror	
33.322 FVL	235 kW		09/91→06/96			
33.332 DF	243 kW		09/87→02/90			
33.332 DFA	243 kW		05/88→02/90			
33.332 DFAK	243 kW		05/88→02/90			
33.332 DFAS	243 kW		05/88→02/90			
33.332 DFK	243 kW		09/87→02/90			
33.332 DFS	243 kW		09/87→02/90			
33.342 DF	250 kW		05/94→06/96			
33.342 DFA	250 kW		05/94→06/96			
33.362 DF	265 kW		09/87→02/90			
33.362 DFA	265 kW		05/88→02/90			
33.362 DFAK	265 kW		05/88→02/90			
33.362 DFAS	265 kW		05/88→02/90			
33.362 DFK	265 kW		09/87→02/90			
33.362 DFS	265 kW		09/87→02/90			
33.372 DF	272 kW		09/91→06/96			
33.372 DFA	272 kW		09/91→06/96			
33.372 DFAK	272 kW		01/91→06/96			
33.372 DFK	272 kW		01/91→06/96			
33.372 DFS	272 kW		09/91→06/96			
33.402 DF	294 kW		05/94→06/96			
33.402 DFA	294 kW		05/94→06/96			
33.402 DFAK	294 kW		05/94→06/96			
33.402 DFK	294 kW		05/94→06/96			
33.402 DFS	294 kW		05/94→06/96			
33.422 DF	309 kW		09/91→06/96			
33.422 DFA	309 kW		09/91→06/96			
33.422 DFAK	309 kW		01/94→06/96			
33.422 DFK	309 kW		01/94→06/96			
33.422 DFS	309 kW		01/94→06/96			
33.462 DF	338 kW		07/89→02/90			
33.462 DFA	338 kW		07/89→02/90			
33.502 DF	368 kW		09/91→06/96			
33.502 DFA	368 kW		09/91→06/96			
35.262 VF	191 kW		02/89→02/90			
35.262 VFA	191 kW		07/89→02/90			
35.262 VFK	191 kW		02/89→02/90			
35.272 VF	198 kW		02/90→12/91			
35.272 VFK	198 kW		02/90→12/92			
35.292 VF	213 kW		10/88→04/95			
35.292 VFK	213 kW		10/88→04/95			
35.302 VF	220 kW		05/90→09/91			
35.302 VFA	220 kW		05/90→09/91			
35.302 VFAK	220 kW		05/90→09/91			
35.302 VFK	220 kW		05/90→09/91			
35.322 VFAK	235 kW		02/90→06/96			
35.322 VFK	235 kW		02/90→06/96			
35.322 VK	235 kW		02/90→06/96			
35.332 VF	243 kW		10/88→04/95			
35.332 VFK	243 kW		10/88→04/95			
35.342 VF	250 kW		05/94→06/96			
35.342 VFK	250 kW		05/94→06/96			
35.362 VF	265 kW		10/88→02/90			
35.362 VFK	265 kW		10/88→02/90			
35.372 VF	249 kW		02/90→04/95			
35.372 VFK	272 kW		02/90→06/96			

Manufacturer - Model	Power	Displ.	Year of Constr.	Remark	Part Number	Page
MAN - F 90						07/86→
35.372 VF	272 kW		02/90→12/97	with oval angled plug	8KA 500 218-002	179
35.372 VFK	249 kW		02/90→04/95		Connecting Cable, outside mirror	
35.372 VFK	272 kW		02/90→06/96			
35.372 VFK	272 kW		02/90→12/97	Right; H 155 mm; without holder; W 245 mm	8SB 501 137-001	166
35.402 VF	294 kW		05/94→06/96		Outside Mirror	
35.402 VF	294 kW		05/94→12/97			
35.402 VFK	294 kW		05/94→06/96	Right; H 155 mm; with holder; W 245 mm	8SB 501 137-031	167
35.402 VFK	294 kW		05/94→12/97		Outside Mirror	
35.422 VF	309 kW		02/90→06/96	Left / Right; H 161 mm; Unheated; W 211 mm	8SB 501 147-021 Wide-angle mirror	182
35.422 VF	309 kW		02/90→12/97			
35.422 VFK	309 kW		02/90→06/96	Left / Right; H 161 mm; Heatable; 24 V; W 211 mm	8SB 501 147-031 Wide-angle mirror	182
35.422 VFK	309 kW		02/90→12/97			
40.372 DF	272 kW		12/91→06/96	Left / Right; H 375 mm; form manual mirror adjustment; + H 168 mm; W 186 mm	8SB 501 156-021	167
40.372 DFA	272 kW		12/91→06/96		Outside Mirror	
40.402 DF	294 kW		05/95→06/96			
40.402 DFA	294 kW		05/95→06/96	Left / Right; H 375 mm; Heatable / form manual mirror adjustment; + H 168 mm; 24 V; W 186 mm	8SB 501 156-031	168
40.422 DF	309 kW		12/91→06/96		Outside Mirror	
40.422 DFA	309 kW		12/91→06/96			
40.462 DF	338 kW		07/89→02/90		9EY 120 010-001 Mirror Glass, outside mirror	183
40.462 DFA	338 kW		07/89→02/90			
40.502 DFA	368 kW		02/90→06/96		9EY 561 814-001 Mirror Glass, wide angle mirror	189
41.262 VF	191 kW		07/89→02/90			
41.262 VFK	191 kW		07/89→02/90	Heatable; 24 V	9MX 561 890-001 Mirror Glass, wide angle mirror	189
41.272 VF	198 kW		02/90→12/91			
41.292 VF	213 kW		10/88→02/90			
41.292 VFK	213 kW		10/88→02/90	Heatable; 24 V	9MX 561 891-001 Mirror Glass, outside mirror	184
41.322 VF	235 kW		02/90→06/96			
41.332 VF	243 kW		10/88→02/90			
41.332 VFK	243 kW		10/88→02/90			
41.342 VF	250 kW		05/94→06/96			
41.362 VF	265 kW		10/88→02/90			
41.362 VFK	265 kW		10/88→02/90			
41.372 VF	272 kW		02/90→06/96			
41.402 VF	294 kW		05/94→06/96			
41.422 VF	309 kW		02/90→06/96			
48.292 VF	213 kW		07/89→02/90			
48.292 VFA	213 kW		07/89→02/90			
48.292 VFAK	213 kW		07/89→02/90			
48.332 VF	243 kW		07/89→02/90			
48.332 VFA	243 kW		07/89→02/90			
48.332 VFAK	243 kW		07/89→02/90			
48.362 VF	265 kW		07/89→02/90			
48.362 VFA	265 kW		07/89→02/90			
48.362 VFAK	265 kW		07/89→02/90			
48.462 VF	338 kW		07/89→02/90			
MAN - F 2000						01/94→
18.273 F, FL, FLL	198 kW		06/94→	Left; H 450 mm; Plug Type ID: 6-polig; W 128 mm	8HG 503 009-022 Holder, outside mirror	180
19.233 FCNG	170 kW					
19.233 FKNG	170 kW					
19.273 F, FL, FLL	198 kW		01/94→	Right; H 450 mm; Plug Type ID: 6-polig; without roof rails; W 128 mm	8HG 503 009-082 Holder, outside mirror	180
19.273 FA	198 kW		01/94→			
19.273 FAK	198 kW		01/94→	Right; H 345 mm; Plug Type ID: 2-polig; W 688 mm	8HG 503 019-012 Holder, outside mirror	180
19.273 FK	198 kW		01/94→			
19.273 FS,19.273 FLS	198 kW		01/94→12/95	Right; H 345 mm; Plug Type ID: 6-polig; W 688 mm	8HG 503 019-022 Holder, outside mirror	181
19.293 FAC	213 kW		01/94→			
19.293 FAK	213 kW		01/94→	Left / Right; H 383 mm; Heatable / for electric mirror adjustment; 24 V; W 206 mm	8SB 501 325-002 Outside Mirror	172
19.293 FAS	213 kW		01/94→			
19.293 FC,19.293 FLC,19.293 FLLC	213 kW		01/94→	Left / Right; H 383 mm; Heatable / form manual mirror adjustment; 24 V; W 206 mm	8SB 501 325-012 Outside Mirror	173
19.293 FK,19.293 FLK	213 kW		01/94→			
19.293 FS,19.293 FLS,19.293 FLLS	213 kW		01/94→	Left / Right; H 383 mm; Heatable / for electric mirror adjustment; 12 V; W 206 mm	8SB 501 325-032 Outside Mirror	174
19.314 FAC	228 kW		05/01→		9HD 563 475-041 Cover, outside mirror	178
19.314 FAK, FA-KI	228 kW		05/01→			
19.314 FAS	228 kW		06/98→			
19.314 FC, FLC, FLLC, FLLW, FRC, FLRC, FLLRC, FLL, FLLR, F-N	228 kW		06/98→	Heatable; 24 V	9MX 563 468-002 Mirror Glass, outside mirror	185
19.314 FK, FLK, F-KI, FL-KI	228 kW		06/98→			
19.314 FS, FLS, FLLS, FRS, FLRS, FLLRS	228 kW		06/98→			
19.323 FAC	235 kW		01/94→12/95			
19.323 FAK	235 kW		01/94→12/95			
19.323 FAS	235 kW		01/94→12/95			
19.323 FC,19.323 FLC,19.323 FLLC	235 kW		01/94→12/95			
19.323 FK,19.323 FLK	235 kW		01/94→12/95			
19.323 FS,19.323 FLS,19.323 FLLS	235 kW		01/94→12/95			
19.343 FAC	250 kW		01/94→			

Manufacturer - Model	Power	Displ.	Year of Constr.	Remark	Part Number	Page
MAN - F 2000						01/94→
19.343 FAK	250 kW		01/94→	Left; H 450 mm; Plug Type ID: 6-polig; W 128 mm	8HG 503 009-022 Holder, outside mirror	180
19.343 FAS	250 kW		01/94→			
19.343 FC, 19.343 FLC, 19.343 FLLC	250 kW		01/94→	Right; H 450 mm; Plug Type ID: 6-polig; without roof rails; W 128 mm	8HG 503 009-082 Holder, outside mirror	180
19.343 FK, 19.343 FLK	250 kW		01/94→			
19.343 FS, 19.343 FLS, 19.343 FLLS	250 kW		01/94→	Right; H 345 mm; Plug Type ID: 2-polig; W 688 mm	8HG 503 019-012 Holder, outside mirror	180
19.364 FAC	265 kW		06/98→	Right; H 345 mm; Plug Type ID: 6-polig; W 688 mm	8HG 503 019-022 Holder, outside mirror	181
19.364 FAK, FA-KI	265 kW		06/98→			
19.364 FAS	265 kW		06/98→			
19.364 FC, FLC, FLLC, FLLW, FRC, FLRC, FLLRC, FLL, FLLR, F-N	265 kW		06/98→	Left / Right; H 383 mm; Heatable / for electric mirror adjustment; 24 V; W 206 mm	8SB 501 325-002 Outside Mirror	172
19.364 FK, FLK, F-KI, FL-KI	265 kW		06/98→	Left / Right; H 383 mm; Heatable / form manual mirror adjustment; 24 V; W 206 mm	8SB 501 325-012 Outside Mirror	173
19.364 FS, FLS, FLLS, FRS, FLRS, FLLRS	265 kW		06/98→	Left / Right; H 383 mm; Heatable / for electric mirror adjustment; 12 V; W 206 mm	8SB 501 325-032 Outside Mirror	174
19.373 FAC	272 kW		01/94→		9HD 563 475-041 Cover, outside mirror	178
19.373 FAK, FA-KI	272 kW		01/94→			
19.373 FAS	272 kW		01/94→	Heatable; 24 V	9MX 563 468-002 Mirror	185
19.373 FC, FLC, FLLC, FRC, FLRC, F-NL	272 kW		01/94→		Glass, outside mirror	
19.373 FK, FLK, F-KI, FL-KI	272 kW		01/94→			
19.373 FS, FLS, FLLS, FRS, FLRS, FLLRS	272 kW		01/94→			
19.403 FAC	294 kW		01/94→			
19.403 FAK, FA-KI	294 kW		01/94→			
19.403 FAS	294 kW		01/94→			
19.403 FC, FLC, FLLC, FRC, FLRC, F-NL	294 kW		01/94→			
19.403 FK, FLK, F-KI, FL-KI	294 kW		01/94→			
19.403 FS, FLS, FLLS, FRS, FLRS, FLLRS	294 kW		01/94→			
19.414 FAC	301 kW		06/98→			
19.414 FAK, FA-KI	301 kW		06/98→			
19.414 FAS	301 kW		06/98→			
19.414 FC, FLC, FLLC, FRC, FLRC, FLLRC, FLL, FLLR, F-NL	301 kW		06/98→			
19.414 FK, FLK, F-KI, FL-KI	301 kW		06/98→			
19.414 FS, FLS, FLLS, FRS, FLRS, FLLRS	301 kW		06/98→			
19.423 FAC	309 kW		01/94→12/95			
19.423 FAK, FA-KI	309 kW		01/94→			
19.423 FAS	309 kW		01/94→12/95			
19.423 FC, FLC, FLLC, F-NL	309 kW		01/94→			
19.423 FK, FLK, F-KI, FL-KI	309 kW		01/94→			
19.423 FS, FLS, FLLS	309 kW		01/94→			
19.463 FAC	338 kW		01/94→			
19.463 FAK, FA-KI	338 kW		01/94→			
19.463 FAS	338 kW		01/94→			
19.463 FC, FLC, FLLC, FRC, FLRC, F-NL	338 kW		01/94→			
19.463 FK, FLK, F-KI, FL-KI	338 kW		01/94→			
19.463 FS, FLS, FLLS, FRS, FLRS, FLLRS	338 kW		01/94→			
19.464 FAC	338 kW		06/98→			
19.464 FAK, FA-KI	338 kW		06/98→			
19.464 FAS	338 kW		06/98→			
19.464 FC, FLC, FLLC, FLL, FRC, FLLR, FLLRC, FLLW, F-NL	338 kW		06/98→			
19.464 FK, FLK, F-KI, FL-KI	338 kW		06/98→			
19.464 FS, FLS, FLLS, FRS, FLRS, FLLRS	338 kW		06/98→			
19.603 FLS, 19604 FLS	441 kW		04/96→			
23.293 FNLLC	213 kW		01/94→			
23.314 FNLLC	228 kW		05/01→			
23.343 FNLLC	250 kW		01/94→			
23.364 FNLLC	265 kW		05/01→			
23.403 FNLLC	294 kW		01/94→			
23.414 FNLLC	301 kW		05/01→			
23.463 FNLLC	338 kW		01/94→			
23.464 FNLLC	338 kW		05/01→			
24.273 FNLLC	198 kW		01/94→12/95			
24.293 FNLLC	213 kW		01/94→			
24.314 FNLLRC	228 kW		05/01→			
24.323 FNLLC	235 kW		01/94→12/95			
24.343 FNLLC	250 kW		01/94→			
24.364 FNLLRC	265 kW		05/01→			
24.373 FNLLC	272 kW		01/94→12/95			
24.403 FNLLC	294 kW		01/94→			
24.414 FNLLRC	301 kW		05/01→			
24.423 FNLLC	309 kW		01/94→12/95			

Manufacturer - Model	Power	Displ.	Year of Constr.	Remark	Part Number	Page
MAN - F 2000						01/94→
24.463 FNLLC	338 kW		01/94→	Left; H 450 mm; Plug Type ID: 6-polig; W 128 mm	8HG 503 009-022	180
24.464 FNLLRC	338 kW		05/01→		Holder, outside mirror	
26.233 FVL CNG	170 kW		09/96→	Right; H 450 mm; Plug Type ID: 6-polig; without roof rails; W 128 mm	8HG 503 009-082	180
26.233 FVL-KO	170 kW		03/00→		Holder, outside mirror	
26.273 DFC,26.273 DFCL	198 kW		01/94→12/95	Right; H 345 mm; Plug Type ID: 2-polig; W 688 mm	8HG 503 019-012	180
26.273 DFK,26.273 DFLK	198 kW		01/94→12/95		Holder, outside mirror	
26.273 DFS,26.273 DFSL	198 kW		01/94→12/95	Right; H 345 mm; Plug Type ID: 6-polig; W 688 mm	8HG 503 019-022	181
26.273 FNLC,26.273 FNLLC, 26.273 FVLC	198 kW		01/94→12/95		Holder, outside mirror	
26.273 FNLS,26.273 FVLS	198 kW		01/94→12/95	Left / Right; H 383 mm; Heatable / for electric mirror adjustment; 24 V; W 206 mm	8SB 501 325-002	172
26.293 DFC,26.293 DFCL	213 kW		01/94→		Outside Mirror	
26.293 DFK,26.293 DFLK	213 kW		01/94→	Left / Right; H 383 mm; Heatable / form manual mirror adjustment; 24 V; W 206 mm	8SB 501 325-012	173
26.293 DFS,26.293 DFSL	213 kW		01/94→		Outside Mirror	
26.293 FNLC,26.293 FNLLC, 26.293 FVLC	213 kW		01/94→	Left / Right; H 383 mm; Heatable / for electric mirror adjustment; 12 V; W 206 mm	8SB 501 325-032	174
26.293 FNLS,26.293 FVLS	213 kW		01/94→		Outside Mirror	
26.314 DFC, DFCL	228 kW		05/01→	Heatable; 24 V	9HD 563 475-041	178
26.314 DFK, DFLK	228 kW		05/01→		Cover, outside mirror	
26.314 DFS, DFSL	228 kW		05/01→	Heatable; 24 V	9MX 563 468-002	185
26.314 DF-TM	228 kW		05/01→		Glass, outside mirror	
26.314 FNLC, FNLLC, FNLLRC, FNLLW, FVLC	228 kW		05/01→			
26.314 FNLS	228 kW		05/01→			
26.314 FVL-KO	228 kW		05/01→			
26.314 FVLS, FVLRS	228 kW		05/01→			
26.323 DFC,26.323 DFCL	235 kW		01/94→12/95			
26.323 DFK,26.323 DFLK	235 kW		01/94→12/95			
26.323 DFS,26.323 DFSL	235 kW		01/94→12/95			
26.323 FNLC,26.323 FNLLC, 26.323 FVLC	235 kW		01/94→12/95			
26.323 FNLS,26.323 FVLS	235 kW		01/94→12/95			
26.343 DFC,26.343 DFCL	250 kW		01/94→			
26.343 DFK,26.343 DFLK	250 kW		01/94→			
26.343 DFS,26.343 DFSL	250 kW		01/94→			
26.343 FNLC,26.343 FNLLC, 26.343 FVLC	250 kW		01/94→			
26.343 FNLS,26.343 FVLS	250 kW		01/94→			
26.364 DFC, DFCL	265 kW		05/01→			
26.364 DFK, DFLK	265 kW		05/01→			
26.364 DFS, DFSL	265 kW		05/01→			
26.364 DF-TM	265 kW		05/01→			
26.364 FNLC, FNLLC, FNLLRC, FNLLW, FVLC	265 kW		05/01→			
26.364 FNLS	265 kW		05/01→			
26.364 FVL-KO	265 kW		05/01→			
26.364 FVLS, FVLRS	265 kW		05/01→			
26.373 DFC,26.373 DFCL	272 kW		01/94→12/95			
26.373 DFK,26.373 DFLK	272 kW		01/94→12/95			
26.373 DFS,26.373 DFSL	272 kW		01/94→12/95			
26.373 FNLC,26.373 FNLLC, 26.373 FVLC	272 kW		01/94→12/95			
26.373 FNLS,26.373 FVLS	272 kW		01/94→12/95			
26.403 DFC,26.403 DFCL	294 kW		01/94→			
26.403 DFK,26.403 DFLK	294 kW		01/94→			
26.403 DFS,26.403 DFSL	294 kW		01/94→			
26.403 FNLC,26.403 FNLLC, 26.403 FVLC	294 kW		01/94→			
26.403 FNLS,26.403 FVLS	294 kW		01/94→			
26.414 DFC, DFCL	301 kW		05/01→			
26.414 DFK, DFLK	301 kW		05/01→			
26.414 DFS, DFSL	301 kW		05/01→			
26.414 DF-TM	301 kW		05/01→			
26.414 FNLC, FNLLC, FNLLRC, FNLLW, FVLC	301 kW		05/01→			
26.414 FNLS	301 kW		05/01→			
26.414 FVL-KO	301 kW		05/01→			
26.414 FVLS, FVLRS	301 kW		05/01→			
26.423 DFC,26.423 DFCL	309 kW		01/94→12/95			
26.423 DFK,26.423 DFLK	309 kW		01/94→12/95			
26.423 DFS,26.423 DFSL	309 kW		01/94→12/95			
26.423 FNLC,26.423 FNLLC, 26.423 FVLC	309 kW		01/94→12/95			
26.423 FNLS,26.423 FVLS	309 kW		01/94→12/95			
26.463 DFC, DFCL	338 kW		01/94→			
26.463 DFK,26.463 DFLK	338 kW		01/94→			
26.463 DFS,26.463 DFSL	338 kW		01/94→			
26.463 FNLC, FNLLC, FVLC	338 kW		01/94→			
26.463 FNLS,26.463 FVLS	338 kW		01/94→			
26.464 DFC, DFCL	338 kW		05/01→			
26.464 DFK, DFLK	338 kW		05/01→			
26.464 DFS, DFSL	338 kW		05/01→			

Manufacturer - Model	Power	Displ.	Year of Constr.	Remark	Part Number	Page
MAN - F 2000						01/94→
26.464 DF-TM	338 kW		05/01→	Left; H 450 mm; Plug Type ID: 6-polig; W 128 mm	8HG 503 009-022	180
26.464 FNLC, FNLLC, FNLLW, FVLC	338 kW		05/01→		Holder, outside mirror	
26.464 FNLS	338 kW		05/01→	Right; H 450 mm; Plug Type ID: 6-polig; without roof rails; W 128 mm	8HG 503 009-082	180
26.464 FVL-KO	338 kW		05/01→		Holder, outside mirror	
26.464 FVLS, FVLSRS	338 kW		05/01→	Right; H 345 mm; Plug Type ID: 2-polig; W 688 mm	8HG 503 019-012	180
26.603 DFC, DFLC	441 kW		06/96→		Holder, outside mirror	
26.603 DFK, DFLK	441 kW		06/96→	Right; H 345 mm; Plug Type ID: 6-polig; W 688 mm	8HG 503 019-022	181
26.603 DFS, DFSL	441 kW		06/96→		Holder, outside mirror	
26.604 DFSL	441 kW		04/00→	Left / Right; H 383 mm; Heatable / for electric mirror adjustment; 24 V; W 206 mm	8SB 501 325-002	172
27.273 DFAC	198 kW		01/94→12/95		Outside Mirror	
27.273 DFAK	198 kW		01/94→12/95	Left / Right; H 383 mm; Heatable / form manual mirror adjustment; 24 V; W 206 mm	8SB 501 325-012	173
27.273 DFAS	198 kW		01/94→12/95		Outside Mirror	
27.273 DFC	198 kW		01/94→12/95	Left / Right; H 383 mm; Heatable / for electric mirror adjustment; 12 V; W 206 mm	8SB 501 325-032	174
27.273 DFK	198 kW		01/94→12/95		Outside Mirror	
27.273 DFS	198 kW		01/94→12/95	Heatable; 24 V	9HD 563 475-041	178
27.293 DFAC	213 kW		01/94→		Cover, outside mirror	
27.293 DFAK	213 kW		01/94→	Heatable; 24 V	9MX 563 468-002	185
27.293 DFAS	213 kW		01/94→		Glass, outside mirror	
27.293 DFC	213 kW		01/94→			
27.293 DFK	213 kW		01/94→			
27.293 DFS	213 kW		01/94→			
27.314 DFAC	228 kW		05/01→			
27.314 DFAK, DFA-KI	228 kW		05/01→			
27.314 DFAS	228 kW		05/01→			
27.314 DFC	228 kW		05/01→			
27.314 DFK, DF-KI	228 kW		05/01→			
27.314 DFS	228 kW		05/01→			
27.314 DF-TM	228 kW		05/01→			
27.314 FVL	228 kW		06/98→			
27.323 DFAC	235 kW		01/94→12/95			
27.323 DFAK, DFA-KI	235 kW		01/94→			
27.323 DFAS	235 kW		01/94→12/95			
27.323 DFC	235 kW		01/94→12/95			
27.323 DFK, DF-KI	235 kW		01/94→			
27.323 DFS	235 kW		01/94→12/95			
27.343 DFAC	250 kW		01/94→			
27.343 DFAK	250 kW		01/94→			
27.343 DFAS	250 kW		01/94→			
27.343 DFC	250 kW		01/94→			
27.343 DFK	250 kW		01/94→			
27.343 DFS	250 kW		01/94→			
27.364 DFAC	265 kW		05/01→			
27.364 DFAK, DFA-KI	265 kW		05/01→			
27.364 DFAS	265 kW		05/01→			
27.364 DFC	265 kW		05/01→			
27.364 DFK, DF-KI	265 kW		05/01→			
27.364 DFS	265 kW		05/01→			
27.364 DF-TM	265 kW		05/01→			
27.364 FVL	265 kW		06/98→			
27.373 DFAC	272 kW		01/94→			
27.373 DFAK, DFA-KI	272 kW		01/94→			
27.373 DFAS	272 kW		01/94→			
27.373 DFC	272 kW		01/94→			
27.373 DFK, DF-KI	272 kW		01/94→			
27.373 DFS	272 kW		01/94→			
27.373 DF-TM	272 kW		07/00→			
27.403 DFAC	294 kW		01/94→			
27.403 DFAK, DFA-KI	294 kW		01/94→			
27.403 DFAS	294 kW		01/94→			
27.403 DFC	294 kW		01/94→			
27.403 DFK, DF-KI	294 kW		01/94→			
27.403 DFS	294 kW		01/94→			
27.403 DF-TM	294 kW		07/00→			
27.414 DFAC	301 kW		05/01→			
27.414 DFAK, DFA-KI	301 kW		05/01→			
27.414 DFAS	301 kW		05/01→			
27.414 DFC	301 kW		05/01→			
27.414 DFK, DF-KI	301 kW		05/01→			
27.414 DFS	301 kW		05/01→			
27.414 DF-TM	301 kW		05/01→			
27.414 FVL	301 kW		06/98→			
27.423 DFAC	309 kW		01/94→			
27.423 DFAK, DFA-KI	309 kW		01/94→			
27.423 DFAS	309 kW		01/94→12/95			
27.423 DFC	309 kW		01/94→			
27.423 DFK, DF-KI	309 kW		01/94→			
27.423 DFS	309 kW		01/94→			
27.423 DF-TM	309 kW		07/00→			
27.463 DFAC	338 kW		01/94→			
27.463 DFAK, DFA-KI	338 kW		01/94→			

Manufacturer - Model	Power	Displ.	Year of Constr.	Remark	Part Number	Page
MAN - F 2000						01/94→
27.463 DFAS	338 kW		01/94→	Left; H 450 mm; Plug Type ID: 6-polig; W 128 mm	8HG 503 009-022	180
27.463 DFC	338 kW		01/94→		Holder, outside mirror	
27.463 DFK, DF-KI	338 kW		01/94→	Right; H 450 mm; Plug Type ID: 6-polig; without roof rails; W 128 mm	8HG 503 009-082	180
27.463 DFS	338 kW		01/94→		Holder, outside mirror	
27.463 DF-TM	338 kW		07/00→	Right; H 345 mm; Plug Type ID: 2-polig; W 688 mm	8HG 503 019-012	180
27.464 DFAC	338 kW		05/01→		Holder, outside mirror	
27.464 DFAK, DFA-KI	338 kW		05/01→	Right; H 345 mm; Plug Type ID: 6-polig; W 688 mm	8HG 503 019-022	181
27.464 DFAS	338 kW		05/01→		Holder, outside mirror	
27.464 DFC	338 kW		01/94→	Left / Right; H 383 mm; Heatable / for electric mirror adjustment; 24 V; W 206 mm	8SB 501 325-002	172
27.464 DFK, DF-KI	338 kW		05/01→		Outside Mirror	
27.464 DFS	338 kW		01/94→	Left / Right; H 383 mm; Heatable / form manual mirror adjustment; 24 V; W 206 mm	8SB 501 325-012	173
27.464 DF-TM	338 kW		05/01→		Outside Mirror	
27.464 FVL	338 kW		06/98→	Left / Right; H 383 mm; Heatable / for electric mirror adjustment; 12 V; W 206 mm	8SB 501 325-032	174
27.603 DFAS	441 kW		01/96→		Outside Mirror	
27.603 DFS	441 kW		01/96→		9HD 563 475-041	178
32.293 VFC	213 kW		08/95→		Cover, outside mirror	
32.314 VF, VFC	228 kW		05/01→	Heatable; 24 V	9MX 563 468-002	185
32.314 VFK, VF-HK	228 kW		05/01→		Glass, outside mirror	
32.314 VF-TM	228 kW		05/01→			
32.343 VFC	250 kW		08/95→			
32.343 VFK	250 kW		08/95→			
32.364 VF, VFC	265 kW		05/01→			
32.364 VFK, VF-HK	265 kW		05/01→			
32.364 VF-TM	265 kW		05/01→			
32.403 VFC	294 kW		08/95→			
32.403 VFK	294 kW		08/95→			
32.414 VF, VFC	301 kW		05/01→			
32.414 VFK, VF-HK	301 kW		05/01→			
32.414 VF-TM	301 kW		05/01→			
32.463 VFC	338 kW		08/95→			
32.463 VFK	338 kW		08/95→			
32.464 VF, VFC	338 kW		05/01→			
32.464 VFK, VF-HK	338 kW		05/01→			
32.464 VF-TM	338 kW		05/01→			
33.323 DFAC	235 kW		01/94→12/95			
33.323 DFAK	235 kW		01/94→12/95			
33.323 DFAS	235 kW		01/94→12/95			
33.323 DFC	235 kW		01/94→12/95			
33.323 DFK	235 kW		01/94→12/95			
33.323 DFS	235 kW		01/94→12/95			
33.343 DFAC	250 kW		01/94→			
33.343 DFAK	250 kW		01/94→			
33.343 DFAS	250 kW		01/94→			
33.343 DFC	250 kW		01/94→			
33.343 DFK	250 kW		01/94→			
33.343 DFS	250 kW		01/94→			
33.364 DFAC	265 kW		05/01→			
33.364 DFAK, DFA-KI	265 kW		05/01→			
33.364 DFAS	265 kW		05/01→			
33.364 DFC	265 kW		05/01→			
33.364 DFK, DF-KI	265 kW		05/01→			
33.364 DFS, DFRS	265 kW		05/01→			
33.373 DFAC	272 kW		01/94→			
33.373 DFAK, DFA-KI	272 kW		01/94→			
33.373 DFAS	272 kW		01/94→			
33.373 DFC	272 kW		01/94→			
33.373 DFK, DF-KI	272 kW		01/94→			
33.373 DFS, DFRS	272 kW		01/94→			
33.403 DFAC	294 kW		01/94→			
33.403 DFAK, DFA-KI	294 kW		01/94→			
33.403 DFAS	294 kW		01/94→			
33.403 DFC	294 kW		01/94→			
33.403 DFK, DF-KI	294 kW		01/94→			
33.403 DFS, DFRS	294 kW		01/94→			
33.414 DFAC	301 kW		05/01→			
33.414 DFAK, DFA-KI	301 kW		05/01→			
33.414 DFAS	301 kW		05/01→			
33.414 DFC	301 kW		05/01→			
33.414 DFK, DF-KI	301 kW		05/01→			
33.414 DFS, DFRS	301 kW		05/01→			
33.423 DFAC	309 kW		01/94→			
33.423 DFAK, DFA-KI	309 kW		01/94→			
33.423 DFAS	309 kW		01/94→			
33.423 DFC	309 kW		01/94→			
33.423 DFK, DF-KI	309 kW		01/94→			
33.423 DFS, DFRS	309 kW		01/94→			
33.463 DFAC	338 kW		01/94→			
33.463 DFAK, DFA-KI	338 kW		01/94→			
33.463 DFAS	338 kW		01/94→			
33.463 DFC	338 kW		01/94→			
33.463 DFK, DF-KI	338 kW		01/94→			

Manufacturer - Model	Power	Displ.	Year of Constr.	Remark	Part Number	Page
MAN - F 2000						01/94→
33.463 DFS, DFRS	338 kW		01/94→	Left; H 450 mm; Plug Type ID: 6-polig; W 128 mm	8HG 503 009-022	180
33.464 DFAC	338 kW		05/01→		Holder, outside mirror	
33.464 DFAK, DFA-KI	338 kW		05/01→	Right; H 450 mm; Plug Type ID: 6-polig; without roof rails; W 128 mm	8HG 503 009-082	180
33.464 DFAS	338 kW		05/01→		Holder, outside mirror	
33.464 DFC	338 kW		05/01→	Right; H 345 mm; Plug Type ID: 2-polig; W 688 mm	8HG 503 019-012	180
33.464 DFK, DF-KI	338 kW		05/01→		Holder, outside mirror	
33.464 DFS, DFRS	338 kW		05/01→	Right; H 345 mm; Plug Type ID: 6-polig; W 688 mm	8HG 503 019-022	181
33.603 DFAC	441 kW		06/96→		Holder, outside mirror	
33.603 DFAS	441 kW		06/96→	Left / Right; H 383 mm; Heatable / for electric mirror adjustment; 24 V; W 206 mm	8SB 501 325-002	172
33.603 DFC	441 kW		06/96→		Outside Mirror	
33.603 DFS	441 kW		06/96→	Left / Right; H 383 mm; Heatable / form manual mirror adjustment; 24 V; W 206 mm	8SB 501 325-012	173
35.314 VF-TM	228 kW		03/02→		Outside Mirror	
35.343 VFC	250 kW		08/95→	Left / Right; H 383 mm; Heatable / for electric mirror adjustment; 12 V; W 206 mm	8SB 501 325-032	174
35.343 VFK	250 kW		08/95→		Outside Mirror	
35.364 VF, VFC, VFRC	265 kW		05/01→	Heatable; 24 V	9HD 563 475-041	178
35.364 VFK, VF-HK, VF-KI	265 kW		03/02→		Cover, outside mirror	
35.364 VF-TM	265 kW		03/02→	Heatable; 24 V	9MX 563 468-002	185
35.373 VF, VFC, VFRC	272 kW		05/01→		Glass, outside mirror	
35.373 VFK, VF-HK, VF-KI	272 kW		03/02→			
35.403 VF, VFC, VFRC	294 kW		08/95→			
35.403 VFK, VF-HK, VF-KI	294 kW		03/02→			
35.414 VF, VFC, VFRC	301 kW		05/01→			
35.414 VFK, VF-HK, VF-KI	301 kW		03/02→			
35.414 VF-TM	301 kW		03/02→			
35.423 VF, VFC	309 kW		05/01→			
35.423 VFK, VF-HK, VF-KI	309 kW		03/02→			
35.463 VF, VFC, VFRC	338 kW		08/95→			
35.463 VFK, VF-HK, VF-KI	338 kW		08/95→			
35.464 VF, VFC, VFRC	338 kW		05/01→			
35.464 VFK, VF-HK, VF-KI	338 kW		03/02→			
35.464 VF-TM	338 kW		03/02→			
37.414 VFA	301 kW		06/98→			
37.464 VFA	338 kW		06/98→			
40.273 DFAC	198 kW		01/94→			
40.273 DFK	198 kW		01/94→			
40.373 DFAC	272 kW		05/01→			
40.373 DFK	272 kW		05/01→			
40.403 DFAC	294 kW		01/94→			
40.403 DFAS	294 kW		01/94→			
40.403 DFK	294 kW		01/94→			
40.403 DFS	294 kW		01/94→			
40.414 DFAC	301 kW		05/01→			
40.414 DFK	301 kW		05/01→			
40.423 DFAC	309 kW		05/01→			
40.423 DFK	309 kW		05/01→			
40.463 DFAC	338 kW		01/94→			
40.463 DFAS	338 kW		01/94→			
40.463 DFK	338 kW		01/94→			
40.463 DFS	338 kW		01/94→			
41.343 VFC	250 kW		08/95→			
41.343 VFK	250 kW		08/95→			
41.364 VF, VFC, VFRC	265 kW		05/01→			
41.364 VFK, VF-HK, VF-KI	265 kW		03/02→			
41.373 VF, VFC, VFRC	272 kW		05/01→			
41.373 VFK, VF-HK, VF-KI	272 kW		03/02→			
41.403 VF, VFC, VFRC	294 kW		08/95→			
41.403 VFK, VF-HK, VF-KI	294 kW		08/95→			
41.414 VF, VFC, VFRC	301 kW		05/01→			
41.414 VFK, VF-HK, VF-KI	301 kW		03/02→			
41.423 VF, VFC, VFRC	309 kW		05/01→			
41.423 VFK, VF-HK, VF-KI	309 kW		03/02→			
41.463 VF, VFC, VFRC	338 kW		08/95→			
41.463 VFK, VF-HK, VF-KI	338 kW		08/95→			
41.464 VF, VFC, VFRC	338 kW		06/98→			
41.464 VFK, VF-HK, VF-KI	338 kW		03/02→			
MAN - G 90						09/87→05/95
10.150 F,10.150 FL	92 kW		05/90→10/93	2 pol; + 1 plug	8KA 560 271-002	179
10.150 F,10.150 FL	110 - 114 kW		09/87→10/93		Connecting Cable, outside mirror	
10.150 FK	110 - 114 kW		09/87→10/93	Right; H 155 mm; without holder; W 245 mm	8SB 501 137-001	166
6.100 F	75 kW		09/87→10/93		Outside Mirror	
6.100 FK	75 kW		09/87→10/93	Right; H 155 mm; with holder; W 245 mm	8SB 501 137-031	167
8.100 F	75 kW		09/87→10/93		Outside Mirror	
8.100 FK	75 kW		09/87→10/93	Left / Right; H 320 mm; Unheated; W 186 mm	8SB 560 991-012	175
8.150 F,8.150 FL	92 kW		05/90→10/93		Outside Mirror	
8.150 F,8.150 FL	110 - 114 kW		09/87→10/93	Left / Right; for mirror pole Ø [mm]: 16 / 18; H 320 mm; Heatable; W 186 mm	8SB 560 991-041	176
8.150 FAE	110 - 114 kW		05/88→05/95		Outside Mirror	
8.150 FAKO	110 kW		10/92→05/95	Left / Right; for mirror pole Ø [mm]: 18; H 320 mm; W 186 mm / W 22 mm	8SB 560 991-061	177
8.150 FK	110 - 114 kW		09/87→10/93		Outside Mirror	
8.150 FOC	110 - 114 kW		07/88→10/93			
8.150 FS,8.150 FLS	110 - 114 kW		09/87→10/93			

Manufacturer - Model	Power	Displ.	Year of Constr.	Remark	Part Number	Page			
MAN - G 90						09/87→05/95			
8.170 FOC	125 - 131 kW		02/89→10/93		9EY 561 042-002 Mirror	183			
9.150 F,9.150 FL	92 kW		05/90→10/93		Glass, outside mirror				
9.150 F,9.150 FL	110 - 114 kW		09/87→10/93	Heatable; 24 V	9MX 561 044-002 Mirror	184			
9.150 FAE	110 - 114 kW		05/88→05/92						
9.150 FAKO	110 kW		10/92→05/95						
9.150 FK	110 - 114 kW		09/87→10/93						
9.150 FOC	110 - 114 kW		07/88→10/93						
9.150 FS,9.150 FLS	110 - 114 kW		09/87→10/93						
9.170 FOC	125 - 131 kW		02/89→10/93						
MAN - G									10/79→08/88
10.136 F,10.136 FL	100 kW		09/81→09/87				2 pol; + 1 plug	8KA 560 271-002	179
10.136 FK	100 kW		09/81→09/87		Connecting Cable,				
6.90 F	66 - 66 kW		10/79→09/87		outside mirror				
6.90 FK	66 kW		10/79→09/87	Right; H 155 mm; without holder; W 245 mm	8SB 501 137-001	166			
8.136 F,8.136 FL	100 kW		10/79→09/87		Outside Mirror				
8.136 FAE	100 kW		12/83→08/88	Right; H 155 mm; with holder; W 245 mm	8SB 501 137-031	167			
8.136 FK	100 kW		10/79→08/88		Outside Mirror				
8.136 FOC	100 kW		03/82→07/88	Left / Right; H 320 mm; Unheated; W 186 mm	8SB 560 991-012	175			
8.90 F	66 kW		10/79→09/87		Outside Mirror				
8.90 FK	66 kW		10/79→09/87		Outside Mirror				
9.136 F,9.136 FL	100 kW		10/79→09/87	Left / Right; for mirror pole Ø [mm]: 16 / 18; H 320 mm; Heatable; W 186 mm	8SB 560 991-041	176			
9.136 FAE	100 kW		12/83→08/88		Outside Mirror				
9.136 FK	100 kW		10/79→08/88	Left / Right; for mirror pole Ø [mm]: 18; H 320 mm; W 186 mm / W 22 mm	8SB 560 991-061	177			
9.136 FOC	100 kW		03/82→07/88		Outside Mirror				
					9EY 561 042-002 Mirror	183			
					Glass, outside mirror				
				Heatable; 24 V	9MX 561 044-002 Mirror	184			
					Glass, outside mirror				
MAN - L 2000						10/93→			
10.145 LC,10.145 LLC, LRC, LLRC (LE140C)	103 kW		09/00→	Left; H 450 mm; Plug Type ID: 6-polig; W 128 mm	8HG 503 009-022	180			
					Holder, outside mirror				
10.145 LK, LRK, L-KI, LR-KI (LE140C)	103 kW		09/00→	Right; H 450 mm; Plug Type ID: 6-polig; without roof rails; W 128 mm	8HG 503 009-082	180			
					Holder, outside mirror				
10.145 LLS, LLRS (LE140C)	103 kW		09/00→	Right; H 345 mm; Plug Type ID: 2-polig; W 688 mm	8HG 503 019-012	180			
10.150 FOC	114 - 118 kW		02/95→01/96		Holder, outside mirror				
10.153 F	114 kW		10/93→	Right; H 345 mm; Plug Type ID: 6-polig; W 688 mm	8HG 503 019-022	181			
10.153 FA	114 kW		10/93→		Holder, outside mirror				
10.153 LAEK	114 kW		10/93→06/96		Holder, outside mirror				
10.153 LC,10.153 LLC	114 kW		10/93→06/96	Left / Right; H 383 mm; Heatable / for electric mirror adjustment; 24 V; W 206 mm	8SB 501 325-002	172			
10.153 LK	114 kW		10/93→06/96		Outside Mirror				
10.153 LLS	114 kW		10/93→06/96	Left / Right; H 383 mm; Heatable / form manual mirror adjustment; 24 V; W 206 mm	8SB 501 325-012	173			
10.155 LK, LRK	114 kW		02/04→		Outside Mirror				
10.163 F	114 kW		05/94→	Left / Right; H 383 mm; Heatable / for electric mirror adjustment; 12 V; W 206 mm	8SB 501 325-032	174			
10.163 FA	114 kW		05/94→		Outside Mirror				
10.163 LAC, LAEC, LARC, LAERC	114 - 118 kW		05/94→						
10.163 LAK, LAEK, LARK, LAERK	114 - 118 kW		01/95→		9HD 563 475-041	178			
					Cover, outside mirror				
10.163 LC,10.163 LLC	114 - 118 kW		05/94→						
10.163 LC,10.163 LLC, LRC, LLRC (LE160C)	114 kW		09/00→		9MX 563 468-002 Mirror	185			
					Glass, outside mirror				
10.163 LK, LRK, L-KI, LR-KI	114 - 118 kW		05/94→						
10.163 LLS, LLRS	114 - 118 kW		05/94→						
10.185 LAC, LAEC, LARC, LAERC, LA-LA, LAE-LF (LE180C)	132 kW		09/00→						
10.185 LAK, LAEK, LARK, LAERK (LE180C)	132 kW		09/00→						
10.185 LC,10.185 LLC, LRC, LLRC (LE180C)	132 kW		09/00→						
10.185 LK, LRK, L-KI, LR-KI (LE180C)	132 kW		09/00→						
10.185 LLS, LLRS (LE180C)	132 kW		09/00→						
10.220 FOC,10.220 FOCL	162 kW		02/95→						
10.223 F, 10.223 FL	162 kW		10/93→06/96						
10.223 FA	162 kW		10/93→06/96						
10.223 LAEC	162 kW		01/95→06/96						
10.223 LC,10.223 LLC	162 - 169 kW		10/93→06/96						
10.223 LK	162 - 169 kW		10/93→06/96						
10.223 LLS	162 - 169 kW		10/93→06/96						
10.224 F, 10.224 FL	162 kW		05/94→						
10.224 FA	162 kW		05/94→						
10.224 LAC, LAEC, LARC, LAERC	162 kW		01/95→						
10.224 LAK, LAEK, LARK, LAERK	162 kW		01/95→						
10.224 LC,10.224 LLC, LRC, LLRC	162 kW		05/94→						

Manufacturer - Model	Power	Displ.	Year of Constr.	Remark	Part Number	Page
MAN - L 2000						10/93→
10.224 LK, LRK, L-KI, LR-KI	162 kW		05/94→	Left; H 450 mm; Plug Type ID: 6-polig; W 128 mm	8HG 503 009-022 Holder, outside mirror	180
10.224 LLS, LLRS	162 kW		05/94→			
10.225 LAC, LAEC, LARC, LAERC, LA-LF, LAE-LF (LE220C)	162 kW		09/00→	Right; H 450 mm; Plug Type ID: 6-polig; without roof rails; W 128 mm	8HG 503 009-082 Holder, outside mirror	180
10.225 LAK, LAEK, LARK, LAERK (LE220C)	162 kW		09/00→	Right; H 345 mm; Plug Type ID: 2-polig; W 688 mm	8HG 503 019-012 Holder, outside mirror	180
10.225 LC, 10.225 LLC, LRC, LLRC	162 kW		09/00→	Right; H 345 mm; Plug Type ID: 6-polig; W 688 mm	8HG 503 019-022 Holder, outside mirror	181
10.225 LC, 10.225 LLC, LRC, LLRC (LE220C)	162 kW		09/00→	Left / Right; H 383 mm; Heatable / for electric mirror adjustment; 24 V; W 206 mm	8SB 501 325-002 Outside Mirror	172
10.225 LK, LRK, L-KI, LR-KI (LE220C)	162 kW		09/00→	Left / Right; H 383 mm; Heatable / form manual mirror adjustment; 24 V; W 206 mm	8SB 501 325-012 Outside Mirror	173
10.225 LLS, LLRS (LE220C)	162 kW		09/00→			
12.185 LC, LLC (LE180C)	132 kW		09/99→	Left / Right; H 383 mm; Heatable / for electric mirror adjustment; 12 V; W 206 mm	8SB 501 325-032 Outside Mirror	174
12.225 LC, LLC (LE220C)	162 kW		09/99→			
8.103 LC, 8.103 LLC	75 kW		10/93→06/96		9HD 563 475-041 Cover, outside mirror	178
8.103 LK	75 kW		10/93→06/96			
8.113 LC, 8.113 LLC	81 kW		08/95→	Heatable; 24 V	9MX 563 468-002 Mirror	185
8.113 LC, 8.113 LLC, LRC, LLRC, (LE110C)	83 kW		09/00→		Glass, outside mirror	
8.113 LK, LRK, L-KI, LR-KI	81 kW		08/95→			
8.145, LA-LF LAE-LF	103 kW		07/00→			
8.145 LC, 8.145 LLC, L-LF (LE140C)	103 kW		09/00→			
8.145 LLS, LLRS (LE140C)	103 kW		09/00→			
8.145 LRK, L-KI, LR-KILK (LE140C)	103 kW		09/00→			
8.150 FOC, 8.150 FOCL	114 - 118 kW		02/95→			
8.153 LAEC	114 kW		01/95→06/96			
8.153 LAEK	114 kW		01/95→09/96			
8.153 LC, 8.153 LLC	114 kW		10/93→07/97			
8.153 LK	114 kW		10/93→07/97			
8.153 LLS	114 kW		10/93→06/96			
8.155 L, LR, LC, LLC, LRC, LLRC, L-LF	114 kW		02/04→			
8.155 LK, LRK	114 kW		02/04→			
8.155 LLS, LLRS	114 kW		02/04→			
8.163 LAC, LAEC, LARC, LAERC, LA-LF, LAE-LF	114 - 118 kW		01/95→			
8.163 LAEC	104 kW		08/95→03/97			
8.163 LAK, LARK, LAEK, LAERK	104 kW		04/00→			
8.163 LC, 8.163 LLC	114 - 118 kW		05/94→			
8.163 LC, 8.163 LLC, LRC, LLRC, L-LF	104 kW		08/95→			
8.163 LC, 8.163 LLC (LE160C)	114 kW		09/00→			
8.163 LK, LRK, L-KI, LR-KI	114 - 118 kW		05/94→			
8.163 LLS, LLRS	114 - 118 kW		05/94→			
8.185 LAC, LAEC, LARC, LAERC, LA-LF, LAE-LF (LE180C)	132 kW		09/00→			
8.185 LAK, LAEK, LARK, LAERK (LE180C)	132 kW		09/00→			
8.185 LC, 8.185 LLC, LRC, LLRC, L-LF (LE180C)	132 kW		09/00→			
8.185 LK, LRK, L-KI, LR-KI (LE180C)	132 kW		09/00→			
8.185 LLS, LLRS (LE180C)	132 kW		09/00→			
8.220 FOC, 8.220 FOCL	162 kW		04/95→			
8.223 LAEC	162 kW		01/95→06/96			
8.223 LC, 8.223 LLC	162 - 169 kW		10/93→06/96			
8.223 LK	162 - 169 kW		10/93→06/96			
8.223 LLS	162 - 169 kW		10/93→06/96			
8.224 LAC, LAEC, LARC, LAERC	162 kW		01/95→			
8.224 LAK, LAEK, LARK, LAERK	162 kW		01/95→			
8.224 LC, 8.224 LLC, LRC, LLRC	162 kW		05/94→			
8.224 LK, LRK, L-KI, LR-KI	162 kW		05/94→			
8.224 LLS, LLRS	162 kW		05/94→			
8.225 LAC, LAEC, LARC, LAERC (LE220C)	162 kW		09/00→			
8.225 LAK, LAEK, LARK, LAERK (LE220C)	162 kW		09/00→			
8.225 LC, 8.225 LLC, LRC, LLRC (LE220C)	162 kW		09/00→			
8.225 LK, LRK, L-KI, LR-KI (LE220C)	162 kW		09/00→			
8.225 LLS, LLRS (LE220C)	162 kW		09/00→			
9.145 LC, 9.145 LLC, LRC, LLRC (LE140C)	103 kW		09/00→			
9.145 LK, LRK, L-KI, LR-KI (LE140C)	103 kW		09/00→			

Manufacturer - Model	Power	Displ.	Year of Constr.	Remark	Part Number	Page
MAN - L 2000						10/93→
9.145 LLS, LLRS (LE140C)	103 kW		09/00→	Left; H 450 mm; Plug Type ID: 6-polig; W 128 mm	8HG 503 009-022 Holder, outside mirror	180
9.153 LC,9.153 LLC	114 kW		10/93→06/96			
9.153 LK	114 kW		10/93→06/96	Right; H 450 mm; Plug Type ID: 6-polig; without roof rails; W 128 mm	8HG 503 009-082 Holder, outside mirror	180
9.153 LLS	114 kW		10/93→12/95			
9.155 L, LC, LLC, LRC, LLRC	114 kW		02/04→			
9.155 LK, LRK	114 kW		02/04→	Right; H 345 mm; Plug Type ID: 2-polig; W 688 mm	8HG 503 019-012 Holder, outside mirror	180
9.155 LLS, LLRS	114 kW		02/04→			
9.163 LC	104 kW		08/95→03/97	Right; H 345 mm; Plug Type ID: 6-polig; W 688 mm	8HG 503 019-022 Holder, outside mirror	181
9.163 LC,9.163 LLC, LRC, LLRC	114 - 118 kW		05/94→			
9.163 LK	104 kW		08/95→03/97	Left / Right; H 383 mm; Heatable / for electric mirror adjustment; 24 V; W 206 mm	8SB 501 325-002 Outside Mirror	172
9.163 LK, LRK, L-KI, LR-KI	114 - 118 kW		05/94→			
9.163 LLS, LLRS	114 - 118 kW		05/94→			
9.185 LC,9.185 LLC, LRC, LLRC (LE180C)	132 kW		09/00→	Left / Right; H 383 mm; Heatable / form manual mirror adjustment; 24 V; W 206 mm	8SB 501 325-012 Outside Mirror	173
9.185 LK, LRK, L-KI, LR-KI (LE180C)	132 kW		09/00→	Left / Right; H 383 mm; Heatable / for electric mirror adjustment; 12 V; W 206 mm	8SB 501 325-032 Outside Mirror	174
9.185 LLS, LLRS (LE 180C)	132 kW		09/00→		9HD 563 475-041 Cover, outside mirror	178
9.223 LC,9.223 LLC	162 - 169 kW		10/93→06/96			
9.223 LK	162 - 169 kW		10/93→06/96	Heatable; 24 V	9MX 563 468-002 Mirror	185
9.223 LLS	162 - 169 kW		10/93→06/96		Glass, outside mirror	
9.224 LC,9.224 LLC, LRC, LLRC	162 kW		05/94→			
9.224 LK, LRK, L-KI, LR-KI	162 kW		05/94→			
9.224 LLS, LLRS	162 kW		05/94→			
9.225 LC,9.225 LLC, LRC, LLRC (LE220C)	162 kW		09/00→			
9.225 LK, LRK, L-KI, LR-KI (LE220C)	162 kW		09/00→			
9.225 LLS, LLRS (LE220C)	162 kW		09/00→			
MAN - LION S STAR						01/93→09/96
FRH 422	309 kW		01/93→09/96	Right; H 661 mm; Heatable / with entry view mirror / with wide angle mirror; 24 V; W 551 mm	8SB 501 246-892 Outside Mirror	170
				Left; Heatable; 24 V	8SB 501 247-803 Outside Mirror	171
MAN - M 90						08/88→06/96
12.152 F,12.152 FL	110 - 114 kW		12/88→05/94	with oval angled plug	8KA 500 218-002 Connecting Cable, outside mirror	179
12.152 FK	110 - 114 kW		12/88→05/94			
12.152 FS,12.152 FLS	110 - 114 kW		12/88→05/94			
12.192 F,12.192 FL	140 kW		07/90→06/96	Right; H 155 mm; without holder; W 245 mm	8SB 501 137-001 Outside Mirror	166
12.192 FA	140 kW		10/92→06/96			
12.192 FAK	140 kW		10/92→06/96	Right; H 155 mm; with holder; W 245 mm	8SB 501 137-031 Outside Mirror	167
12.192 FK	140 kW		07/90→06/96			
12.192 FS,12.192 FLS	140 kW		07/90→06/96			
12.222 F,12.222 FL	162 kW		05/94→06/96	Left / Right; H 161 mm; Unheated; W 211 mm	8SB 501 147-021 Wide-angle mirror	182
12.222 FA	162 kW		05/94→06/96			
12.222 FAK	162 kW		05/94→06/96	Left / Right; H 161 mm; Heatable; 24 V; W 211 mm	8SB 501 147-031 Wide-angle mirror	182
12.222 FK	162 kW		05/94→06/96			
12.222 FLS	162 kW		05/94→06/96	Left / Right; H 375 mm; form manual mirror adjustment; + H 168 mm; W 186 mm	8SB 501 156-021 Outside Mirror	167
12.232 F,12.232 FL	169 kW		08/88→06/96			
12.232 FA	169 kW		05/90→06/96	Left / Right; H 375 mm; Heatable / form manual mirror adjustment; + H 168 mm; 24 V; W 186 mm	8SB 501 156-031 Outside Mirror	168
12.232 FAK	169 kW		05/90→06/96			
12.232 FK	169 kW		08/88→06/96			
12.232 FS,12.232 FLS	169 kW		08/88→06/96		9EY 120 010-001 Mirror	183
12.262 F,12.262 FL	191 kW		08/95→06/96		Glass, outside mirror	
12.262 FK	191 kW		08/95→06/96		9EY 561 814-001 Mirror	189
12.262 FS,12.262 FLS	191 kW		08/95→06/96		Glass, wide angle mirror	
12.272 F,12.272 FL	198 kW		09/91→10/92	Heatable; 24 V	9MX 561 890-001 Mirror	189
12.272 F,12.272 FL	198 kW		10/92→06/96		Glass, wide angle mirror	
12.272 FA	198 kW		10/93→04/95	Heatable; 24 V	9MX 561 891-001 Mirror	184
12.272 FAK	198 kW		10/93→04/95		Glass, outside mirror	
12.272 FK	198 kW		09/91→10/92			
12.272 FK	198 kW		10/92→06/96			
12.272 FS,12.272 FLS	198 kW		09/91→10/92			
12.272 FS,12.272 FLS	198 kW		10/92→06/96			
14.152 F,14.152 FL	110 - 114 kW		12/88→04/94			
14.152 F,14.152 FL	114 kW		05/94→06/96			
14.152 FK	110 - 114 kW		12/88→05/94			
14.152 FK	114 kW		05/94→06/96			
14.152 FS,14.152 FLS	110 - 114 kW		12/88→05/94			
14.152 FS,14.152 FLS	114 kW		05/94→06/96			
14.162 F,14.162 FL	118 kW		08/95→06/96			
14.162 FK	118 kW		08/95→06/96			
14.162 FS,14.162 FLS	118 kW		08/95→06/96			
14.192 F,14.192 FL	137 kW		08/88→06/90			
14.192 F,14.192 FL	140 kW		07/90→06/96			
14.192 FA	137 kW		08/88→06/90			
14.192 FK	137 kW		08/88→06/90			
14.192 FK	140 kW		07/90→06/96			
14.192 FS,14.192 FLS	137 kW		08/88→06/90			

Manufacturer - Model	Power	Displ.	Year of Constr.	Remark	Part Number	Page
MAN - M 90						08/88→06/96
14.192 FS,14.192 FLS	140 kW		07/90→06/96	with oval angled plug	8KA 500 218-002	179
14.222 F,14.222 FL	162 kW		05/94→06/96		Connecting Cable, outside mirror	
14.222 FK	162 kW		05/94→06/96			
14.222 FLS	162 kW		05/94→06/96	Right; H 155 mm; without holder; W 245 mm	8SB 501 137-001	166
14.232 F,14.232 FL	160 kW		05/90→04/95		Outside Mirror	
14.232 F,14.232 FL	169 kW		08/88→06/96	Right; H 155 mm; with holder; W 245 mm	8SB 501 137-031	167
14.232 FK	169 kW		08/88→06/96		Outside Mirror	
14.232 FS,14.232 FLS	160 kW		05/90→04/95			
14.232 FS,14.232 FLS	169 kW		08/88→06/96	Left / Right; H 161 mm; Unheated; W 211 mm	8SB 501 147-021	182
14.262 F,14.262 FL	191 kW		08/95→06/96		angle mirror	
14.262 FK	191 kW		08/95→06/96	Left / Right; H 161 mm; Heatable; 24 V; W 211 mm	8SB 501 147-031	182
14.262 FS,14.262 FLS	191 kW		08/95→06/96		angle mirror	
14.272 F,14.272 FL	198 kW		09/91→10/92	Left / Right; H 375 mm; form manual mirror adjustment; + H 168 mm; W 186 mm	8SB 501 156-021	167
14.272 F,14.272 FL	198 kW		10/92→06/96		Outside Mirror	
14.272 FK	198 kW		09/91→10/92	Left / Right; H 375 mm; Heatable / form manual mirror adjustment; + H 168 mm; 24 V; W 186 mm	8SB 501 156-031	168
14.272 FK	198 kW		10/92→06/96		Outside Mirror	
14.272 FS,14.272 FLS	198 kW		09/91→10/92			
14.272 FS,14.272 FLS	198 kW		12/92→06/96		9EY 120 010-001	183
17.192 F,17.192 FL	137 kW		08/88→06/90		Glass, outside mirror	
17.192 F,17.192 FL	140 kW		07/90→04/95		9EY 561 814-001	189
17.192 FA	137 kW		02/89→06/90		Glass, wide angle mirror	
17.192 FA	140 kW		07/90→06/96	Heatable; 24 V	9MX 561 890-001	189
17.192 FAK	137 kW		02/89→06/90		Glass, wide angle mirror	
17.192 FAK	140 kW		07/90→06/96	Heatable; 24 V	9MX 561 891-001	184
17.192 FK	137 kW		08/88→06/90		Glass, outside mirror	
17.192 FK	140 kW		07/90→01/91			
17.192 FS,17.192 FLS	137 kW		08/88→06/90			
17.192 FS,17.192 FLS	140 kW		07/90→04/95			
17.222 FA	162 kW		05/94→06/96			
17.222 FAK	162 kW		05/94→06/96			
17.232 F,17.232 FL	160 kW		05/90→04/95			
17.232 F,17.232 FL	169 kW		08/88→04/95			
17.232 FA	160 kW		05/90→04/95			
17.232 FA	169 kW		02/89→06/96			
17.232 FAK	160 kW		05/90→04/95			
17.232 FAK	169 kW		02/89→06/96			
17.232 FK	160 kW		05/90→01/91			
17.232 FK	169 kW		08/88→01/91			
17.232 FS,17.232 FLS	160 kW		05/90→04/95			
17.232 FS,17.232 FLS	169 kW		08/88→04/95			
17.272 FLS	198 kW		09/91→05/95			
17.272 FLS	198 kW		10/92→05/95			
18.192 F,18.192 FL,18.192 FLL	140 kW		09/90→06/96			
18.192 FK	140 kW		09/90→06/96			
18.222 F,18.222 FL,18.222 FLL	162 kW		05/94→06/96			
18.222 FK	162 kW		05/94→06/96			
18.232 F,18.232 FL,18.232 FLL	169 kW		09/90→06/96			
18.232 FK	169 kW		09/90→06/96			
18.262 F,18.262 FL,18.262 FLL	191 kW		08/95→06/96			
18.262 FK	191 kW		08/95→06/96			
18.272 F,18.272 FL,18.272 FLL	198 kW		09/91→05/94			
18.272 F,18.272 FL,18.272 FLL	198 kW		10/92→06/96			
18.272 FK	198 kW		09/91→05/94			
18.272 FK	198 kW		10/92→06/96			
24.192 FNL,24.192 FNLL,24.192 FVL	140 kW		07/89→06/96			
24.222 FNL,24.222 FNLL,24.222 FVL	162 kW		05/94→06/96			
24.232 FNL	160 kW		05/90→04/95			
24.232 FNL,24.232 FNLL,24.232 FVL	169 kW		07/89→06/96			
24.262 FNL,24.262 FNLL,24.262 FVL	191 kW		08/95→06/96			
24.272 FNL,24.272 FNLL,24.272 FVL	198 kW		10/92→06/96			
24.272 FNL,24.272 FVL	198 kW		09/91→05/94			
MAN - NG						07/98→
NG 262, NG 263	191 kW		07/98→	Left; H 450 mm; Plug Type ID: 6-polig; W 128 mm	8HG 503 009-022	180
NG 312, NG 313	228 kW		07/98→	Right; H 450 mm; Plug Type ID: 6-polig; without roof rails; W 128 mm	8HG 503 009-082	180
				Right; H 345 mm; Plug Type ID: 2-polig; W 688 mm	8HG 503 019-012	180
				Right; H 345 mm; Plug Type ID: 6-polig; W 688 mm	8HG 503 019-022	181
				Left / Right; H 383 mm; Heatable / for electric mirror adjustment; 24 V; W 206 mm	8SB 501 325-002	172
				Left / Right; H 383 mm; Heatable / form manual mirror adjustment; 24 V; W 206 mm	8SB 501 325-012	173

Manufacturer - Model	Power	Displ.	Year of Constr.	Remark	Part Number	Page				
MAN - NG						07/98→				
NG 262, NG 263 NG 312, NG 313	191 kW		07/98→	Left / Right; H 383 mm; Heatable / for electric mirror adjustment; 12 V; W 206 mm	8SB 501 325-032	174				
	228 kW		07/98→		Outside Mirror	9HD 563 475-041	178			
					Heatable; 24 V	9MX 563 468-002 Mirror	185			
				Glass, outside mirror						
NG 313	228 kW			Left; H 450 mm; Plug Type ID: 6-polig; W 128 mm	8HG 503 009-022	180				
				Holder, outside mirror						
				Right; H 450 mm; Plug Type ID: 6-polig; without roof rails; W 128 mm	8HG 503 009-082	180				
				Holder, outside mirror						
				Right; H 345 mm; Plug Type ID: 2-polig; W 688 mm	8HG 503 019-012	180				
				Holder, outside mirror						
				Right; H 345 mm; Plug Type ID: 6-polig; W 688 mm	8HG 503 019-022	181				
				Holder, outside mirror						
			Left / Right; H 383 mm; Heatable / for electric mirror adjustment; 24 V; W 206 mm	8SB 501 325-002	172					
			Left / Right; H 383 mm; Heatable / form manual mirror adjustment; 24 V; W 206 mm	8SB 501 325-012	173					
			Left / Right; H 383 mm; Heatable / for electric mirror adjustment; 12 V; W 206 mm	8SB 501 325-032	174					
				Outside Mirror						
MAN - NL						07/98→				
NL 262, NL 263	191 kW		07/98→	Left; H 450 mm; Plug Type ID: 6-polig; W 128 mm	8HG 503 009-022	180				
					Holder, outside mirror					
					Right; H 450 mm; Plug Type ID: 6-polig; without roof rails; W 128 mm	8HG 503 009-082	180			
						Holder, outside mirror				
						Right; H 345 mm; Plug Type ID: 2-polig; W 688 mm	8HG 503 019-012	180		
							Holder, outside mirror			
							Right; H 345 mm; Plug Type ID: 6-polig; W 688 mm	8HG 503 019-022	181	
								Holder, outside mirror		
								Left / Right; H 383 mm; Heatable / for electric mirror adjustment; 24 V; W 206 mm	8SB 501 325-002	172
									Outside Mirror	
Left / Right; H 383 mm; Heatable / form manual mirror adjustment; 24 V; W 206 mm	8SB 501 325-012	173								
	Outside Mirror									
	Left / Right; H 383 mm; Heatable / for electric mirror adjustment; 12 V; W 206 mm	8SB 501 325-032	174							
		Outside Mirror								
			9HD 563 475-041	178						
		Cover, outside mirror								
		Heatable; 24 V	9MX 563 468-002 Mirror	185						
		Glass, outside mirror								
		MAN - NM						08/87→		
		NM 222, NM 223 NM 223	162 kW 162 kW		02/96→ 08/87→	Left; H 450 mm; Plug Type ID: 6-polig; W 128 mm	8HG 503 009-022	180		
Holder, outside mirror										
Right; H 450 mm; Plug Type ID: 6-polig; without roof rails; W 128 mm							8HG 503 009-082	180		
	Holder, outside mirror									
	Right; H 345 mm; Plug Type ID: 2-polig; W 688 mm						8HG 503 019-012	180		
							Holder, outside mirror			
							Right; H 345 mm; Plug Type ID: 6-polig; W 688 mm	8HG 503 019-022	181	
								Holder, outside mirror		
								Left / Right; H 383 mm; Heatable / for electric mirror adjustment; 24 V; W 206 mm	8SB 501 325-002	172
									Outside Mirror	
		Left / Right; H 383 mm; Heatable / form manual mirror adjustment; 24 V; W 206 mm	8SB 501 325-012	173						
			Outside Mirror							
Left / Right; H 383 mm; Heatable / for electric mirror adjustment; 12 V; W 206 mm			8SB 501 325-032	174						
			Outside Mirror							
			9HD 563 475-041	178						
	Cover, outside mirror									
	Heatable; 24 V		9MX 563 468-002 Mirror	185						
	Glass, outside mirror									
	MAN - NÜ						09/96→			
	NÜ 263 NÜ 263		191 kW 191 kW		09/96→07/98 07/98→	Left; H 450 mm; Plug Type ID: 6-polig; W 128 mm	8HG 503 009-022	180		
		Holder, outside mirror								
		Right; H 450 mm; Plug Type ID: 6-polig; without roof rails; W 128 mm					8HG 503 009-082	180		
Holder, outside mirror										
Right; H 345 mm; Plug Type ID: 2-polig; W 688 mm							8HG 503 019-012	180		
							Holder, outside mirror			
							Right; H 345 mm; Plug Type ID: 6-polig; W 688 mm	8HG 503 019-022	181	
								Holder, outside mirror		
	Left / Right; H 383 mm; Heatable / for electric mirror adjustment; 24 V; W 206 mm		8SB 501 325-002	172						
			Outside Mirror							
		Left / Right; H 383 mm; Heatable / form manual mirror adjustment; 24 V; W 206 mm	8SB 501 325-012	173						
			Outside Mirror							

Manufacturer - Model	Power	Displ.	Year of Constr.	Remark	Part Number	Page
MAN - NÜ						09/96→
NÜ 263	191 kW		09/96→07/98	Left / Right; H 383 mm; Heatable / for electric mirror adjustment; 12 V; W 206 mm	8SB 501 325-032	174
NÜ 263	191 kW		07/98→		9HD 563 475-041	178
					Heatable; 24 V	9MX 563 468-002 Mirror Glass, outside mirror
MAN - TGA						04/00→
18.310, 18.320 FAC, FHLC	228 - 235 kW		05/04→	Right; H 399 mm; Heatable / for electric mirror adjustment; 24 V; W 222 mm	8SB 354 504-021	166
18.310, 18.320 FAK, FAK-L, FALK, FALK-L, FHLK, FHLK/M	228 - 235 kW		05/04→		Outside Mirror	
18.310, 18.320 FAS, FALS, FHLS, FHLS/M	228 - 235 kW		05/04→	Right; Heatable / for electric mirror adjustment; 24 V	8SB 354 509-001 Ramp Mirror	181
18.310, 18.320 FC, FLC, FLLC, FLLC/N, FLLW, FLLW/N	228 - 235 kW		05/04→	Left	9HB 863 835-001	178
18.310, 18.320 FK, FK-L, FLK, FLK/M	228 - 235 kW		05/04→	Left	9HB 863 839-001	178
18.310, 18.320 FLS, FLRS, FLLS, FLLRS	228 - 235 kW		05/04→	Right	9HB 863 840-001	178
18.310, 18320 FC, FLC, FRC, FLLC, FLLC/N, FLLW, FLLRC, FLLRW	228 - 235 kW		04/00→	Fulfills ECE norm.: 2003/38 / 2003/97; Heatable / for electric mirror adjustment; 24 V	9MX 564 249-001 Mirror Glass, outside mirror	186
18.310, 18320 FK, FLK, FK-L, FLRK	228 - 235 kW		12/00→	Right; Heatable / for electric mirror adjustment; 24 V	9MX 863 838-001 Mirror	187
18.310 FAC, FARC	228 kW		09/02→	Fulfills ECE norm.: 2003/38 / 2003/97; Heatable / for electric mirror adjustment; 24 V	9MX 863 839-011 Mirror	190
18.310 FAK, FAK-L, FALK	228 kW		09/02→		Glass, wide angle mirror	
18.310 FAS, FARS	228 kW		09/02→	Fulfills ECE norm.: 2003/38 / 2003/97; Heatable / for electric mirror adjustment; 24 V	9MX 863 847-011 Mirror	188
18.310 FLS, FLLS, FLLS/N, FLS-TS, FLRS, FLLRS	228 kW		04/00→		Glass, ramp mirror	
18.350, 18.360 FAC, FHLC	257 - 265 kW		05/04→			
18.350, 18.360 FAK, FAK-L, FALK, FALK-L, FHLK, FHLK/M	257 - 265 kW		05/04→			
18.350, 18.360 FAS, FALS, FHLS, FHLS/M	257 - 265 kW		05/04→			
18.350, 18.360 FC, FLC, FLLC, FLLRC, FLLC/N, FLLW, FLLW/N	257 - 265 kW		05/04→			
18.350, 18.360 FK, FK-L, FLK, FLK/M,	257 - 265 kW		05/04→			
18.350 FLS, FLS/N, FLS/M, FLS-TS, FLLS, FLLS/N, FLLRS	257 kW		05/04→			
18.360 FAC, FARC	265 kW		09/02→			
18.360 FAK, FALK, FAK-L, FALK-L	265 kW		09/02→			
18.360 FAS, FALS, FARS	265 kW		09/02→			
18.360 FC, FLC, FRC, FLLC, FLLC/N, FLLW, FLLRW	265 kW		04/00→			
18.360 FK, FLK, FK-L, FLRK	265 kW		12/00→			
18.360 FLS, FLLS, FLLS/N, FLS-TS, FLRS, FLLRS	265 kW		04/00→			
18.360 FLS, FLLS, FLRS, FLLRS	265 kW		01/06→			
18.390, 18.400 FAC, FHLC	287 - 294 kW		05/04→			
18.390, 18.400 FAK, FAK-L, FALK, FALK-L, FHLK, FHLK/M	287 - 294 kW		05/04→			
18.390, 18.400 FAS, FALS, FHLS, FHLS/M	287 - 294 kW		05/04→			
18.390, 18.400 FC, FLC, FLLC, FLLC/N, FLLW, FLLW/N	287 - 294 kW		05/04→			
18.390, 18.400 FK, FK-L, FLK, FLK/M	287 - 294 kW		05/04→			
18.390 FLS, FLS-TS, FLS/M, FLLS, FLLS/N, FLLS/M, FLLRS	287 kW		05/04→			
18.400 FLS, FLLS, FLRS, FLLRS	294 kW		10/05→			
18.410, 18420 FAK, FAK-L, FALK	301 - 309 kW		09/02→			
18.410, 18420 FC, FRC, FLC, FLRC, FLLC, FLLC/N, FLLW, FLLRC	301 - 309 kW		04/00→			
18.410, 18420 FK, FK-L, FLK, FLRK	301 - 309 kW		12/00→			
18.410 FAC, FARC	301 kW		09/02→			
18.410 FAS, FALS, FARS	301 kW		09/02→			
18.410 FLS, FLLS, FLLS/N, FLS-TS, FLRS, FLLRS	301 kW		04/00→			
18.430, 18.440 FAC, FHLC	316 - 324 kW		05/04→			
18.430, 18.440 FAK, FALK, FALK-L, FHLK, FHLK/M	316 - 324 kW		05/04→			
18.430, 18.440 FAS, FALS, FHLS, FHLS/M	316 - 324 kW		05/04→			
18.430, 18.440 FC, FLC, FLLC, FLLW, FLLW/N, FLLRC, FLLRW	316 - 324 kW		05/04→			

Manufacturer - Model	Power	Displ.	Year of Constr.	Remark	Part Number	Page
MAN - TGA						04/00→
18.430, 18.440 FK, FK-L, FLK, FLK/M	316 - 324 kW		05/04→	Right; H 399 mm; Heatable / for electric mirror adjustment; 24 V; W 222 mm	8SB 354 504-021 Outside Mirror	166
18.430 FLS, FLS/M, FLS-TS, FLLS, FLLS/N, FLLRS, FLRS	316 kW		05/04→	Right; Heatable / for electric mirror adjustment; 24 V	8SB 354 509-001 Mirror	Ramp 181
18.440 FLS, FLLS, FLRS, FLLRS	324 kW		09/05→	Left	9HB 863 835-001 Cover, outside mirror	178
18.460 FAK	338 kW		12/00→	Left	9HB 863 839-001 Cover, wide angle mirror	178
18.460 FC, FLC, FRC, FLLC, FLLC/N, FLLW, FLLRC, FLLRW	338 kW		04/00→	Right	9HB 863 840-001 Cover, wide angle mirror	178
18.460 FK, FK-L, FLK, FLRK	338 kW		12/00→			
18.460 FLS, FLLS, FLLS/N, FLS-TS, FLRS, FLLRS	338 kW		04/00→			
18.480 FAC	353 kW		02/06→	Fulfills ECE norm.: 2003/38 / 2003/97; Heatable / for electric mirror adjustment; 24 V	9MX 564 249-001 Mirror	186
18.480 FAC, FARC	353 kW		09/02→			
18.480 FAK, FAK-L, FALK	353 kW		09/02→	Right; Heatable / for electric mirror adjustment; 24 V	9MX 863 838-001 Mirror	187
18.480 FAK, FALK	353 kW		02/06→			
18.480 FAS, FALS	353 kW		02/06→	Fulfills ECE norm.: 2003/38 / 2003/97; Heatable / for electric mirror adjustment; 24 V	9MX 863 839-011 Mirror	190
18.480 FAS, FALS, FARS	353 kW		09/02→			
18.480 FC, FLC, FLLC, FLLRC, FLLW, FLRC	353 kW		01/06→	Fulfills ECE norm.: 2003/38 / 2003/97; Heatable / for electric mirror adjustment; 24 V	9MX 863 847-011 Mirror	188
18.480 FC, FLC, FLLC, FLLW, FLLRW, FLLRC	353 kW		09/02→			
18.480 FHLK	353 kW		04/06→			
18.480 FHLK, FHLK/M	353 kW		04/06→			
18.480 FHLS, FHLS/M	353 kW		04/06→			
18.480 FK, FK-L, FLK	353 kW		01/06→			
18.480 FK, FLK, FK-L	353 kW		09/02→			
18.480 FLS, FLLS, FLLS/N, FLS-TS, FLRS-WW	353 kW		09/02→			
18.480 FLS, FLLS, FLRS, FLLRS	353 kW		01/06→			
18.510 FC, FLC, FRC, FLLC, FLLC/N, FLLW, FLLRC, FLLRW	375 kW		09/00→			
18.510 FLS, FLLS, FLLS/N, FLRS, FLLRS	375 kW		04/00→			
18.530 FAC	390 kW		04/04→			
18.530 FAK, FALK	390 kW		04/04→			
18.530 FAS, FALS	390 kW		04/04→			
18.530 FC, FLC, FLLC, FLLC/N, FLLW, FLLRC, FLLRW	390 kW		09/02→			
18.530 FLS, FLLS, FLLS/N	390 kW		09/02→			
18.540 FLC, FLRC, FLLC, FLLRC, FLLW	397 kW		08/06→			
18.540 FLS, FLRS, FLLS, FLLRS	397 kW		08/06→			
19.350 FS, FRS, FLS, FLRS-WW	257 kW		05/04→			
19.360 FS, FRS, FLS, FLRS-WW	265 kW		05/04→			
19.360 FS/M-WW, FRS/M-WW	265 kW		05/04→			
19.390 FS, FRS, FLS, FLRS-WW	287 kW		05/04→			
19.400 FS/M-WW, FRS/M-WW, FLS, FLRS	294 kW		05/04→			
19.410 FS/M-WW, FRS/M-WW	301 kW		05/04→			
19.430 FS/M-WW, FLS, FRS, FLRS	316 kW		05/04→			
19.440 FRS, FS/M-WW, FLS, FLRS	324 kW		02/06→			
19.460 FS/M-WW, FRS/M-WW	338 kW		05/04→			
19.480 FLS, FRS, FLRS-WW	353 kW		02/06→			
19.480 FS/M, FRS/M-WW	353 kW		02/06→			
19.480 FS/M-WW, FRS/M-WW	353 kW		05/04→			
24.350, 24.360 FNLLC, FNLLW/N, FNLLRW	257 - 265 kW		05/04→			
24.350, 24.360 FPLS, FPLRS	257 - 265 kW		02/04→			
24.360 FNLLC/N, FNLLW, FNLLRW, FNLLRC	265 kW		09/01→			
24.390, 24.400 FNLLC/N, FNLLW/N, FNLLRC, FNLLRW	287 - 294 kW		05/04→			
24.390, 24.400 FPLS, FPLRS	287 - 294 kW		05/04→			
24.410 FNLLC/N, FNLLW, FNLLRW	301 kW		09/01→			
24.430, 24.440 FNLLC/N, FNLR, FNLLW	316 - 324 kW		05/04→			
24.430, 24.440 FPLS, FPLRS	316 - 324 kW		05/04→			
24.460 FNLLC/N, FNLLW, FNLLRC, FNLLRW	338 kW		09/01→			
24.480 FNLLC/N, FNLLW, FNLLRC, FNLLRW	353 kW		09/02→			
24.480 FNLLC/N, FNLLW/N	353 kW		01/06→			
24.480 FPLS, FPLRS	353 kW		07/05→			
24.480 FPLS, FPLRS	353 kW		01/06→			
24.510 FNLLC/N, FNLLW, FNLLRW	375 kW		09/01→			
24.530 FNLLC/N, FNLLW, FNLLRW	390 kW		09/01→			

Manufacturer - Model	Power	Displ.	Year of Constr.	Remark	Part Number	Page
MAN - TGA						04/00→
24.530 FPLS, FPLRS	390 kW		07/05→	Right; H 399 mm; Heatable / for electric mirror adjustment; 24 V; W 222 mm	8SB 354 504-021	166
24.540 FNLLC/N, FLLCW/N	397 kW		01/06→		Outside Mirror	
26.280 FNLC, FNLLC, FNLLW	206 kW		11/02→			
26.310, 26.320 FDC, FDRC, FDC/M, FDRC/M, FDLC, FNHLC, FVHLC	228 - 235 kW		05/04→	Right; Heatable / for electric mirror adjustment; 24 V	8SB 354 509-001	Ramp Mirror 181
26.310, 26.320 FDH, FDHC, FDHC/M	228 - 235 kW		06/05→	Left	9HB 863 835-001	178
26.310, 26.320 FDHK	228 - 235 kW		06/05→	Left	9HB 863 839-001	178
26.310, 26.320 FDHS, FDHS/M	228 - 235 kW		06/05→	Right	9HB 863 840-001	178
26.310, 26.320 FDH-TM	228 - 235 kW		06/05→		Cover, wide angle mirror	
26.310, 26.320 FDK, FDLK	228 - 235 kW		05/04→			
26.310, 26.320 FDS, FDS/M, FDLs, FDRS, FDRS/M, FNHLS, FDLRS	228 - 235 kW		05/04→	Fulfills ECE norm.: 2003/38 / 2003/97; Heatable / for electric mirror adjustment; 24 V	9MX 564 249-001	Mirror Glass, outside mirror 186
26.310, 26.320 FD-TM	228 - 235 kW		06/05→	Right; Heatable / for electric mirror adjustment; 24 V	9MX 863 838-001	Mirror Glass, outside mirror 187
26.310, 26.320 FNLC, FNLLC, FNLR, FNLLRC, FNLLW	228 - 235 kW		05/04→	Fulfills ECE norm.: 2003/38 / 2003/97; Heatable / for electric mirror adjustment; 24 V	9MX 863 839-011	Mirror Glass, wide angle mirror 190
26.310, 26.320 FNLS, FNLLS, FNLRs, FNLLRS	228 - 235 kW		05/04→	Fulfills ECE norm.: 2003/38 / 2003/97; Heatable / for electric mirror adjustment; 24 V	9MX 863 847-011	Mirror Glass, ramp mirror 188
26.310, 26.320 FVHL-KO	228 - 235 kW		06/05→			
26.310, 26.320 FVLC	228 - 235 kW		02/04→			
26.310, 26.320 FVL-KO	228 - 235 kW		02/04→			
26.310 FDAC	228 kW		01/04→			
26.310 FDAC, FDARC	228 kW		02/02→			
26.310 FDAK	228 kW		02/02→			
26.310 FDAK	228 kW		01/04→			
26.310 FDAS	228 kW		01/04→			
26.310 FDAS, FDARS	228 kW		02/02→			
26.310 FDC, FDLC, FDRC, FDLC/M, FDLRC	228 kW		01/01→			
26.310 FDK, FDLK, FDRK	228 kW		09/02→			
26.310 FDS, FDLs, FDLs/M, FDLRS	228 kW		01/01→			
26.310 FD-TM, FDR-TM	228 kW		10/00→			
26.310 FNLC, FNLLC, FVLC, FNLLW, FNLR, FNLLRW	228 kW		09/00→			
26.310 FPLS, FVLS, FNLS, FNLLS, FPLRS, FNLRs, FVLRs	228 kW		12/00→			
26.310 FVLC	228 kW		09/03→			
26.310 FVL-KO	228 kW		12/00→			
26.320 FDAC	235 kW		04/06→			
26.320 FDAK	235 kW		04/06→			
26.320 FDAS	235 kW		04/06→			
26.330 FNLC, FNLLC, FNLLW	240 kW		11/02→			
26.350, 26.360 FDC, FDRC, FDC/M, FDRC/M, FDLC, FDLRC, FNHLC	257 - 265 kW		05/04→			
26.350, 26.360 FDHK, FDHLK	257 - 265 kW		05/04→			
26.350, 26.360 FDHS, FDHS/M, FDHLS	257 - 265 kW		05/04→			
26.350, 26.360 FDH-TM	257 - 265 kW		05/04→			
26.350, 26.360 FDK, FDLK, FDRK	257 - 265 kW		05/04→			
26.350, 26.360 FDS, FDS/M, FDLs, FDRS, FNHLS, FPHLS	257 - 265 kW		05/04→			
26.350, 26.360 FD-TM	257 - 265 kW		02/04→			
26.350, 26.360 FNLC, FNLLC, FNLLW, FNLR, FNLLRC	257 - 265 kW		05/04→			
26.350, 26.360 FNLS, FNLLS, FNLRs, FNLLRS, FPLS, FPLRS	257 - 265 kW		05/04→			
26.350, 26.360 FVHL-KO	257 - 265 kW		06/05→			
26.350, 26.360 FVL-KO	257 - 265 kW		01/04→			
26.350 FDAC	257 kW		02/04→			
26.350 FDAK	257 kW		02/04→			
26.350 FDAS	257 kW		02/04→			
26.350 FDHC, FDHC/M	257 kW		04/05→			
26.350 FDLRC-WW	257 kW		05/04→			
26.350 FDLs, FDLRS, FDLRS/M, FDLRS-WW	257 kW		05/04→			
26.350 FVHLC	257 kW		06/05→			
26.350 FVHLS	257 kW		07/05→			
26.350 FVLC	257 kW		01/04→			
26.350 FVLS, FVLRs	257 kW		07/05→			
26.360 FDAC, FDARC	265 kW		02/02→			
26.360 FDAK, FDARK	265 kW		06/04→			
26.360 FDAK, FDALK	265 kW		02/02→			
26.360 FDAK, FDARK	265 kW		06/04→			
26.360 FDAS, FDARS	265 kW		02/02→			
26.360 FDAS, FDARS	265 kW		06/04→			

Manufacturer - Model	Power	Displ.	Year of Constr.	Remark	Part Number	Page
MAN - TGA						04/00→
26.360 FDC, FDLC, FDLC/M, FDRC, FDLRC-WW	265 kW		01/01→	Right; H 399 mm; Heatable / for electric mirror adjustment; 24 V; W 222 mm	8SB 354 504-021 Outside Mirror	166
26.360 FDHC, FDHLC	265 kW		05/04→	Right; Heatable / for electric mirror adjustment; 24 V	8SB 354 509-001 Mirror	Ramp 181
26.360 FDK, FDLK, FDRK, FDLRK	265 kW		09/02→			
26.360 FDLC-WW, FDLRC	265 kW		05/04→	Left	9HB 863 835-001	178
26.360 FDLS, FDLRS-WW, FNHLS	265 kW		05/04→	Left	9HB 863 839-001	178
26.360 FDLS, FDLS/M, FDLRS, FDLRS/M, FDLRS-WW, FDRS	265 kW		09/03→	Right	9HB 863 840-001	178
26.360 FDS, FDLS, FNLS, FNLLS, FPLS, FPLRS, FVLS, FVLR	265 kW		12/00→		9MX 564 249-001	186
26.360 FD-TM, FDR-TM	265 kW		01/01→	Fulfil ECE norm.: 2003/38 / 2003/97; Heatable / for electric mirror adjustment; 24 V	9MX 863 838-001	Mirror 187
26.360 FNLC, FNLLC, FNLLW, FNLLRC, FNLLRW, FVLC	265 kW		09/00→			
26.360 FVHLC	265 kW		04/06→	Fulfil ECE norm.: 2003/38 / 2003/97; Heatable / for electric mirror adjustment; 24 V	9MX 863 839-011	Mirror 190
26.360 FVHLS	265 kW		04/06→			
26.360 FVLC	265 kW		04/06→	Fulfil ECE norm.: 2003/38 / 2003/97; Heatable / for electric mirror adjustment; 24 V	9MX 863 847-011	Mirror 188
26.360 FVL-KO	265 kW		12/00→			
26.360 FVLS, FVLR	265 kW		04/06→			
26.390, 26.400 FDC, FDRC, FDLRC, FDRC/M, FDLC, FNHLC, FVHLC	287 - 294 kW		05/04→			
26.390, 26.400 FDHC, FDHC/M, FDHLC	287 - 294 kW		06/05→			
26.390, 26.400 FDHK, FDHLK	287 - 294 kW		06/05→			
26.390, 26.400 FDHS, FDHS/M, FDHLS	287 - 294 kW		06/05→			
26.390, 26.400 FDK, FDLK	287 - 294 kW		05/04→			
26.390, 26.400 FDS, FDS/M, FDLS, FDLRS, FNHLS, FPHLS, FVHLS	287 - 294 kW		05/04→			
26.390, 26.400 FD-TM	287 - 294 kW		05/04→			
26.390, 26.400 FNLC, FNLLC, FNLLW, FNLR, FNLLRC	287 - 294 kW		05/04→			
26.390, 26.400 FNLS, FNLLS, FNLR, FNLLRS, FPLS, FPLRS	287 - 294 kW		05/04→			
26.390, 26.400 FVHL-KO	287 - 294 kW		06/05→			
26.390, 26.400 FVL-KO	287 - 294 kW		02/04→			
26.390 FDAC, FDALC	287 kW		01/04→			
26.390 FDAK, FDALK	287 kW		02/04→			
26.390 FDAS, FDALS	287 kW		02/04→			
26.390 FDH-TM	287 kW		06/05→			
26.390 FVLC	287 kW		02/04→			
26.390 FVLS, FVLR	287 kW		07/05→			
26.400 FDAC, FDALC	294 kW		01/04→			
26.400 FDAK, FDALK	294 kW		01/04→			
26.400 FDAS, FDALS	294 kW		01/04→			
26.400 FDH-TM	294 kW		04/06→			
26.400 FVLC	294 kW		04/06→			
26.400 FVLS, FVLR	294 kW		04/06→			
26.410 FDAC, FDARC	301 kW		02/02→			
26.410 FDAK, FDALK	301 kW		02/02→			
26.410 FDAS, FDALS, FDARS	301 kW		02/02→			
26.410 FDC, FDLC, FDLC/M, FDLC-WW; FDRC-WW, FDLRC-WW	301 kW		01/01→			
26.410 FDK, FDRK, FDLK, FDLRK	301 kW		09/01→			
26.410 FDS, FDLS, FDLS/M, FDLS-WW, FDRS-WW, FDLRS-WW	301 kW		06/01→			
26.410 FD-TM, FDR-TM	301 kW		01/01→			
26.410 FNLC, FNLLC, FNLLW, FNLR, FNLLRC, FVLC	301 kW		04/00→			
26.410 FPLS, FPLRS, FVLS, FNLS, FNLLS	301 kW		12/00→			
26.410 FVLC	301 kW		09/03→			
26.410 FVL-KO	301 kW		12/00→			
26.410 FVLS, FVLR	301 kW		07/05→			
26.430, 26.440, FNLC, FNLLC, FNLLW, FNLR, FNLLRC, FVLC	316 - 324 kW		05/04→			
26.430, 26.440, FNLS, FNLLS, FNLR, FNLLRS, FPLS, FPLRS	316 - 324 kW		05/04→			
26.430, 26.440 FDC, FDRC, FDLC, FDLRC, FDLC/M, FNHLC, FVHLC	316 - 324 kW		05/04→			
26.430, 26.440 FDHC, FDHC/M, FDHLC	316 - 324 kW		06/05→			
26.430, 26.440 FDHK, FDHLK	316 - 324 kW		06/05→			

Manufacturer - Model	Power	Displ.	Year of Constr.	Remark	Part Number	Page
MAN - TGA						04/00→
26.430, 26.440 FDHS, FDHS/M, FDHLS	316 - 324 kW		06/05→	Right; H 399 mm; Heatable / for electric mirror adjustment; 24 V; W 222 mm	8SB 354 504-021 Outside Mirror	166
26.430, 26.440 FDH-TM	316 - 324 kW		06/05→	Right; Heatable / for electric mirror adjustment; 24 V	8SB 354 509-001 Mirror	Ramp 181
26.430, 26.440 FDK, FDLK	316 - 324 kW		05/04→			
26.430, 26.440 FDS, FDLS, FDRS, FDLRS, FNHLS, FPHLS, FVHLS	316 - 324 kW		02/04→	Left	9HB 863 835-001 Cover, outside mirror	178
26.430, 26.440 FD-TM	316 - 324 kW		05/04→	Left	9HB 863 839-001 Cover, wide angle mirror	178
26.430, 26.440 FVLH-KO	316 - 324 kW		06/05→	Right	9HB 863 840-001 Cover, wide angle mirror	178
26.430 FDAC, FDALC	316 kW		01/04→			
26.430 FDAK, FDALK	316 kW		01/04→			
26.430 FDAS, FDALS	316 kW		01/04→			
26.430 FDLS, FDLS/M, FDLRS-WW	316 - 324 kW		02/04→	Fulfils ECE norm.: 2003/38 / 2003/97; Heatable / for electric mirror adjustment; 24 V	9MX 564 249-001 Mirror	186
26.430 FVL-KO	316 kW		12/00→	Right; Heatable / for electric mirror adjustment; 24 V	9MX 863 838-001 Glass, outside mirror	187
26.430 FVLS, FVLRS	316 kW		07/05→			
26.440 FDAC, FDALC	324 kW		09/05→	Fulfils ECE norm.: 2003/38 / 2003/97; Heatable / for electric mirror adjustment; 24 V	9MX 863 839-011 Mirror	190
26.440 FDAK, FDALK	324 kW		01/04→			
26.440 FDAS, FDALS	324 kW		01/04→			
26.440 FDLK-WW, FDLRC-WW	324 kW		02/06→	Fulfils ECE norm.: 2003/38 / 2003/97; Heatable / for electric mirror adjustment; 24 V	9MX 863 847-011 Mirror	188
26.440 FDS, FDLS, FDLS-WW, FDLRS-WW	324 kW		02/06→			
26.440 FVL-KO	324 kW		09/05→			
26.440 FVLS, FVLRS	324 kW		09/05→			
26.460 FDC, FDLC, FDLC/M, FDLC-WW, FDRC, FDLRC-WW	338 kW		01/01→			
26.460 FDK, FDLK, FDLRK	338 kW		01/01→			
26.460 FDS, FDLS, FDLS/M, FDLS-WW, FDRS-WW, FDLRS-WW	338 kW		06/01→			
26.460 FD-TM, FDR-TM	338 kW		01/01→			
26.460 FNLC, FNLCR, FNLLC, FNLLRW, FNLLRC	338 kW		04/00→			
26.460 FPLS, FPLRS, FVLS, FVLRS, FNLS, FNLLS, FNLR	338 kW		12/00→			
26.460 FVLC	338 kW		02/01→			
26.460 FVL-KO	338 kW		12/00→			
26.480 FDAC, FDALC	353 kW		02/06→			
26.480 FDAC, FDALC, FDARC	353 kW		09/02→			
26.480 FDAK, FDALK	353 kW		09/02→			
26.480 FDAK, FDALK	353 kW		02/06→			
26.480 FDAS, FDALS	353 kW		02/06→			
26.480 FDAS, FDALS, FDARS	353 kW		09/02→			
26.480 FDC, FDC/M, FDLC, FDLRC, FDRC, FNHLC, FVHLC, FDLRC-WW	353 kW		02/06→			
26.480 FDC, FDLC, FDRC, FDLC/M, FDLRC-WW	353 kW		09/02→			
26.480 FDHC, FDHC/M, FDHLC	353 kW		02/06→			
26.480 FDHK, FDHLK	353 kW		02/06→			
26.480 FDHS, FDHS/M, FDHLS	353 kW		02/06→			
26.480 FDH-TM	353 kW		02/06→			
26.480 FDK, FDLK	353 kW		02/06→			
26.480 FDK, FDLK, FDLRK	353 kW		09/02→			
26.480 FDS, FDLS, FDLRS, FNHLS, FPHLS, FVHLS	353 kW		02/06→			
26.480 FDS, FDLS, FDLS/M, FDLRS-WW, FDRS	353 kW		09/02→			
26.480 FD-TM	353 kW		09/02→			
26.480 FD-TM	353 kW		02/06→			
26.480 FNLC, FNLLC, FVLC, FNLLRC, FVLLW	353 kW		09/02→			
26.480 FNLC, FNLCR-WW, FNLLC, FNLLRC, FNLLW, FVLC	353 kW		02/06→			
26.480 FNLS, FNLLS, FNLR, FPLS, FVLS	353 kW		09/02→			
26.480 FNLS, FNLLS, FNLR, FPLS, FVLS, FVLRS	353 kW		02/06→			
26.480 FVHL-KO	353 kW		02/06→			
26.480 FVL-KO	353 kW		09/02→			
26.480 FVL-KO	353 kW		01/06→			
26.510 FDC, FDC/M, FDRC, FDLC, FDLC/M, FDLRC	375 kW		01/01→			
26.510 FDS, FDLS, FDLS/M, FDRS, FDLRS	375 kW		01/01→			
26.510 FNLC, FNLLC, FNLLW, FNLLRC, FVLC	375 kW		12/00→			
26.510 FNLS, FNLLS, FNLR, FPLS, FVLS	375 kW		12/00→			
26.530 FDAC, FDALC	390 kW		07/06→			
26.530 FDAK, FDALK	390 kW		09/02→			

Manufacturer - Model	Power	Displ.	Year of Constr.	Remark	Part Number	Page
MAN - TGA						04/00→
26.530 FDAS, FDALS	390 kW		07/06→	Right; H 399 mm; Heatable / for electric mirror adjustment; 24 V; W 222 mm	8SB 354 504-021	166
26.530 FDC, FDLC, FDC/M, FDLRC	390 kW		01/01→		Outside Mirror	
26.530 FDK, FDLK, FDLRK	390 kW		09/02→	Right; Heatable / for electric mirror adjustment; 24 V	8SB 354 509-001	Ramp 181
26.530 FDS, FDLS, FDLS/M, FDLRS	390 kW		01/01→		Mirror	
26.530 FNLC, FNLLC, FNLLW, FNLLRC, FVLC, FVLRC	390 kW		09/02→	Left	9HB 863 835-001	178
26.530 FNLS, FNLLS, FNLRs, FPLS, FVLS, FVLRS	390 kW		09/02→	Left	9HB 863 839-001	178
26.540 FNLC, FNLLC, FNLLRC, FNLLW	397 kW		08/06→	Right	9HB 863 840-001	178
27.440 FDS, FDLS, FDRS, FDLRS	324 kW		10/08→	Fulfills ECE norm.: 2003/38 / 2003/97; Heatable / for electric mirror adjustment; 24 V	9MX 564 249-001	Mirror 186 Glass, outside mirror
28.310, 28.320 FNLC, FNLLC, FNLL-LE, FNLLR-LE	228 - 235 kW		07/06→	Right; Heatable / for electric mirror adjustment; 24 V	9MX 863 838-001	Mirror 187 Glass, outside mirror
28.310, 28.320 FNLC, FNLLC, FNLLRC, FNLLR-LE	228 - 235 kW		07/06→	Fulfills ECE norm.: 2003/38 / 2003/97; Heatable / for electric mirror adjustment; 24 V	9MX 863 839-011	Mirror 190 Glass, wide angle mirror
28.310 FNLC, FNLLC	228 kW		09/02→	Fulfills ECE norm.: 2003/38 / 2003/97; Heatable / for electric mirror adjustment; 24 V	9MX 863 847-011	Mirror 188 Glass, ramp mirror
28.310 FNLC, FNLLC, FNLR	228 kW		09/02→			
28.310 FNLS, FNLRs	228 kW		09/02→			
28.310 FNLS, FNLRs	228 kW		06/04→			
28.320 FNLC, FNLLC, FNLR	235 kW		06/04→			
28.320 FNLS, FNLRs	235 kW		06/04→			
28.350, 28.360 FNLC, FNLLC, FNLL-LE	257 - 265 kW		07/06→			
28.350, 28.360 FNLC, FNLLC, FNLR, FNLL-LE	257 - 265 kW		06/04→			
28.350 FANLC	257 kW		07/06→			
28.350 FANLK	257 kW		07/06→			
28.350 FNLS, FNLRs-WW	257 kW		02/04→			
28.360 FANLC	265 kW		07/06→			
28.360 FANLK	265 kW		07/06→			
28.360 FNLC, FNLLC	265 kW		09/02→			
28.360 FNLS, FNLRs	265 kW		09/02→			
28.360 FNLS, FNLRs-WW	265 kW		04/06→			
28.390, 28.400 FNLC, FNLLC, FNLR-WW	287 - 294 kW		06/04→			
28.390 FANLC	287 kW		07/06→			
28.390 FANLK	287 kW		07/06→			
28.390 FNLLC	353 kW		07/06→			
28.390 FNLS, FNLRs	287 kW		05/04→			
28.400 FANLC	294 kW		07/06→			
28.400 FANLK	294 kW		07/06→			
28.400 FNLS, FNLRs	294 kW		04/06→			
28.410 FANLC	301 kW		07/06→			
28.410 FANLK	301 kW		07/06→			
28.410 FNLC, FNLLC	301 kW		09/02→			
28.410 FNLC, FNLLC, FNLR	301 kW		09/02→			
28.410 FNLS, FNLRs	301 kW		09/02→			
28.430, 28.440 FNLC, FNLLC, FNLR-WW	316 - 324 kW		06/04→			
28.430 FANLC	316 kW		07/06→			
28.430 FANLK	316 kW		07/06→			
28.430 FNLS, FNLRs-WW	316 kW		05/04→			
28.440 FANLC	324 kW		07/06→			
28.440 FANLK	324 kW		07/06→			
28.440 FNLS, FNLRs-WW	324 kW		09/05→			
28.460 FNLC, FNLLC, FNLR	338 kW		09/02→			
28.460 FNLS, FNLRs	338 kW		09/02→			
28.480 FANLC	353 kW		07/06→			
28.480 FANLK	353 kW		07/06→			
28.480 FNLC, FNLLC, FNLR	353 kW		09/02→			
28.480 FNLC, FNLR-WW, FNLLC	353 kW		02/06→			
28.480 FNLS, FNLRs	353 kW		09/02→			
28.480 FNLS, FNLRs-WW	353 kW		02/06→			
28.510 FNLC, FNLLC, FNLR	375 kW		09/02→			
28.510 FNLS, FNLRs	375 kW		09/02→			
28.530 FANLC	390 kW		07/06→			
28.530 FANLK	390 kW		07/06→			
28.530 FNLC, FNLLC, FNLR	390 kW		09/02→			
28.530 FNLS, FNLRs	390 kW		09/02→			
28.540 FNLC, FNLLC	397 kW		08/06→			
28.540 FNLS	397 kW		08/06→			
32.310 FFDC, FFDLC, FFDLRC	228 kW		01/02→			
32.310 FFDK, FFDLK	228 kW		01/02→			
32.310 FFD-TM	228 kW		01/02→			
32.350, 32.360 FFDRC	257 - 265 kW		05/04→			
32.350, 32.360 FFD-TM, FFDR-TM	257 - 265 kW		02/04→			

Manufacturer - Model	Power	Displ.	Year of Constr.	Remark	Part Number	Page
MAN - TGA						04/00→
32.360 FFDC, FFDLC, FFDLRC	265 kW		01/02→	Right; H 399 mm; Heatable / for electric mirror adjustment; 24 V; W 222 mm	8SB 354 504-021 Outside Mirror	166
32.360 FFDK, FFDLK	265 kW		01/02→			
32.360 FFD-TM	265 kW		01/02→			
32.390, 32.400 FFDR	287 - 294 kW		05/04→	Right; Heatable / for electric mirror adjustment; 24 V	8SB 354 509-001 Mirror	Ramp 181
32.390, 32.400 FFD-TM, FFDR-TM	287 - 294 kW		05/04→			
32.410 FFDC, FFDLC, FFDR, FFDLRC	301 kW		01/02→	Left	9HB 863 835-001 Cover, outside mirror	178
32.410 FFDK, FFDLK	301 kW		01/02→	Left	9HB 863 839-001 Cover, wide angle mirror	178
32.410 FFD-TM	301 kW		01/02→			
32.430, 32.440 FFDR	316 - 324 kW		05/04→	Right	9HB 863 840-001 Cover, wide angle mirror	178
32.430, 32.440 FFD-TM, FFDR-TM	316 - 324 kW		05/04→			
32.460 FFDC, FFDLC, FFDLRC	338 kW		01/02→	Fulfills ECE norm.: 2003/38 / 2003/97; Heatable / for electric mirror adjustment; 24 V	9MX 564 249-001 Mirror	186
32.460 FFDK, FFDLK	338 kW		01/02→			
32.460 FFD-TM	338 kW		01/02→			
32.480 FFDC, FFDLC, FFDLRC	353 kW		09/02→	Right; Heatable / for electric mirror adjustment; 24 V	9MX 863 838-001 Glass, outside mirror	187
32.480 FFDK, FFDLK	353 kW		09/02→			
32.480 FFDR	353 kW		02/06→	Fulfills ECE norm.: 2003/38 / 2003/97; Heatable / for electric mirror adjustment; 24 V	9MX 863 839-011 Mirror	190
32.480 FFD-TM	353 kW		09/02→			
32.480 FFD-TM, FFDR-TM	353 kW		02/06→			
33.350, 33.360 FDAC, FDHC, FDHC/M	257 - 265 kW		06/05→			
33.350, 33.360 FDAK, FDHK	257 - 265 kW		06/05→			
33.350, 33.360 FDAS, FDHS, FDHS/M	257 - 265 kW		06/05→			
33.350, 33.360 FDC, FDC/M, FDLC, FDRC	257 - 265 kW		05/04→			
33.350, 33.360 FDK, FDLK, FDRK	257 - 265 kW		05/04→			
33.350, 33.360 FDS, FDLS, FDS/M, FDRS	257 - 265 kW		05/04→			
33.350 FDC-TM, FDRC-TM	257 kW		09/07→			
33.360 FDAC, FDARC, FDAC-WW	265 kW		09/02→			
33.360 FDAK, FDAK-WW	265 kW		09/02→			
33.360 FDAS, FDAS-WW	265 kW		09/02→			
33.360 FDC, FDC-WW, FDLC/M, FDRC-WW, FDLRC	265 kW		10/00→			
33.360 FDC-TM, FDRC-TM	265 kW		09/07→			
33.360 FDK, FDK-WW, FDLK, FDRK-WW	265 kW		01/01→			
33.360 FDS, FDS-WW, FDLS, FDLRS, FDRS-WW	265 kW		10/00→			
33.360 FD-TM, FDR-TM	265 kW		01/01→			
33.390, 33.400 FDAC, FDHC, FDHC/M	287 - 295 kW		06/05→			
33.390, 33.400 FDAK, FDHK	287 - 295 kW		06/05→			
33.390, 33.400 FDAS, FDHS, FDHS/M	287 - 295 kW		06/05→			
33.390, 33.400 FDC, FDLC, FDRC, FDC/M	287 - 294 kW		05/04→			
33.390, 33.400 FDC-TM, FDRC-TM	287 - 294 kW		09/07→			
33.390, 33.400 FDK, FDLK, FDRK	287 - 294 kW		05/04→			
33.390, 33.400 FDS, FDLS, FDLRS, FDRS, FDS/M	287 - 294 kW		05/04→			
33.410 FDAC, FDAC-WW, FDALC	301 kW		09/02→			
33.410 FDAK, FDAK-WW, FDALK	301 kW		09/02→			
33.410 FDAS, FDAS-WW, FDALS	301 kW		09/02→			
33.410 FDC, FDC-WW, FDLC, FDLRC, FDRC-WW	301 kW		10/00→			
33.410 FDK, FDK-WW, FDLK, FDRK-WW	301 kW		10/00→			
33.410 FDS, FDS-WW, FDLS, FDLRS, FDRS, FDS/M	301 kW		10/00→			
33.410 FD-TM, FDR-TM	301 kW		10/00→			
33.430, 33.440 FDAC, FDALC, FDHC, FDHC/M	316 - 324 kW		06/05→			
33.430, 33.440 FDAK, FDALK, FDHK	316 - 324 kW		06/05→			
33.430, 33.440 FDAS, FDALS, FDHS	316 - 324 kW		06/05→			
33.430, 33.440 FDC, FDLC, FDRC, FDLRC, FDC/M	316 - 324 kW		05/04→			
33.430, 33.440 FDK, FDLK, FDRK	316 - 324 kW		05/04→			

Manufacturer - Model	Power	Displ.	Year of Constr.	Remark	Part Number	Page
MAN - TGA						04/00→
33.430, 33.440 FDS, FDLs, FDRS, FDLRS, FDS/M	316 - 324 kW		05/04→	Right; H 399 mm; Heatable / for electric mirror adjustment; 24 V; W 222 mm	8SB 354 504-021 Outside Mirror	166
33.440 FDAC, FDHC	324 kW		06/05→	Right; Heatable / for electric mirror adjustment; 24 V	8SB 354 509-001 Mirror	Ramp
33.440 FDAK, FDHK	324 kW		06/05→			
33.440 FDAS, FDHS	324 kW		06/05→	Left	9HB 863 835-001 Cover, outside mirror	
33.440 FDC, FDRC	324 kW		06/05→			
33.440 FDC-TM, FDRC-TM	324 kW		09/07→	Left	9HB 863 839-001 Cover, wide angle mirror	
33.440 FDK, FDRK	324 kW		06/05→			
33.440 FDS, FDRS	324 kW		06/05→	Right	9HB 863 840-001 Cover, wide angle mirror	
33.460 FDAC-WW	338 kW		09/02→			
33.460 FDAK-WW	338 kW		09/02→	Fulfils ECE norm.: 2003/38 / 2003/97; Heatable / for electric mirror adjustment; 24 V	9MX 564 249-001 Mirror	186
33.460 FDAS-WW	338 kW		09/02→			
33.460 FDC, FDC-WW, FDLc, FDLRC, FDRC-WW	338 kW		09/02→	Right; Heatable / for electric mirror adjustment; 24 V	9MX 863 838-001 Glass, outside mirror	Mirror
33.460 FDK, FDK-WW, FDLK, FDRK-WW	338 kW		09/02→			
33.460 FDS, FDLs, FDLs/M, FDLRS, FDRS-WW	338 kW		09/02→	Fulfils ECE norm.: 2003/38 / 2003/97; Heatable / for electric mirror adjustment; 24 V	9MX 863 839-011 Mirror	190
33.460 FD-TM, FDR-TM	338 kW		09/02→			
33.480 FDAC, FDAC-WW, FDALC, FDARC	353 kW		02/06→	Fulfils ECE norm.: 2003/38 / 2003/97; Heatable / for electric mirror adjustment; 24 V	9MX 863 847-011 Mirror	188
33.480 FDAC, FDALC, FDHC, FDHC/M	353 kW		02/06→			
33.480 FDAK, FDAK-WW, FDALK	353 kW		09/02→	02/06→		
33.480 FDAK, FDALK, FDHK	353 kW		02/06→			
33.480 FDAS, FDALS, FDHS	353 kW		09/02→	09/02→		
33.480 FDAS, FDAS-WW, FDARS, FDALS	353 kW		09/02→			
33.480 FDC, FDC-WW, FDLc, FDRC-WW, FDLRC	353 kW		01/06→	09/02→		
33.480 FDC, FDLc, FDRc, FDC/M	353 kW		09/07→			
33.480 FDC-TM, FDRc-TM	353 kW		09/02→	01/06→		
33.480 FDK, FDK-WW, FDLK, FDRK-WW	353 kW		01/06→			
33.480 FDK, FDLK, FDRK	353 kW		01/06→	09/02→		
33.480 FDS, FDRS, FDLs, FDS/M	353 kW		09/02→			
33.480 FDS, FDS-WW, FDLs, FDLs/M, FDRS-WW, FDLRS	353 kW		09/02→	09/02→		
33.480 FD-TM	353 kW		09/02→			
33.510 FDC, FDC/M, FDLc, FDRc, FDLRC	375 kW		09/02→	09/02→		
33.510 FDS, FDLs/M, FDRS, FDLRS/M	375 kW		09/02→			
33.530 FDAC, FDALC	390 kW		09/02→	09/02→		
33.530 FDAK, FDALK	390 kW		09/02→			
33.530 FDAS, FDALS	390 kW		07/03→	07/03→		
33.530 FDC, FDC/M, FDLc, FDRc, FDLRC	390 kW		07/03→			
33.530 FDK, FDLK	390 kW		02/04→	02/04→		
33.530 FDS, FDLs, FDLs/M, FDRS, FDLRS	390 kW		02/04→			
35.310, 35.320 FFDC, FFDLC	228 - 235 kW		02/04→	06/03→		
35.310, 35.320 FFDK, FFDLK	228 - 235 kW		02/04→			
35.310, 35.320 FFD-TM	228 - 235 kW		06/03→	11/03→		
35.310 FFDC, FFDLC	228 kW		06/03→			
35.310 FFDK, FFDLK	228 kW		02/04→	02/04→		
35.310 FFD-TM	228 kW		02/04→			
35.350, 35.360 FFDC, FFDRC, FFDLC	257 - 265 kW		02/04→	07/06→		
35.350, 35.360 FFDK, FFDRC, FFDLK	257 - 265 kW		07/06→			
35.350, 35.360 FFD-TM	257 - 265 kW		07/06→	07/06→		
35.350 FFDHK, FFDHLK	257 kW		07/06→			
35.350 FFDH-TM	257 kW		07/06→	10/03→		
35.350 FFNLC	257 kW		07/06→			
35.360 FFDC, FFDLC	265 kW		07/06→	07/06→		
35.360 FFDHK, FFDHLK	265 kW		07/06→			
35.360 FFDH-TM	265 kW		10/03→	11/03→		
35.360 FFDK, FFDLK	265 kW		10/03→			
35.360 FFD-TM	265 kW		07/06→	07/06→		
35.360 FFNHLC	265 kW		07/06→			
35.360 FFNLC	265 kW		02/04→	02/04→		
35.390, 35.400 FFDC, FFDRC, FFDLC	287 - 294 kW		02/04→			
35.390, 35.400 FFDK, FFDRC, FFDLK	287 - 294 kW		02/04→	02/04→		
35.390, 35.400 FFD-TM	287 - 294 kW		07/06→			
35.390 FDNLC	287 kW					

Manufacturer - Model	Power	Displ.	Year of Constr.	Remark	Part Number	Page
MAN - TGA						04/00→
35.390 FFDK	287 kW		02/04→	Right; H 399 mm; Heatable / for electric mirror adjustment; 24 V; W 222 mm	8SB 354 504-021	166
35.390 FFDK, FFDHK, FFDHLK	287 kW		07/06→		Outside Mirror	
35.390 FFDH-TM	287 kW		07/06→	Right; Heatable / for electric mirror adjustment; 24 V	8SB 354 509-001	Ramp 181
35.390 FFNLC	287 kW		07/06→		Mirror	
35.400 FDNLC	294 kW		07/06→	Left	9HB 863 835-001	178
35.400 FFDK	294 kW		02/04→		Cover, outside mirror	
35.400 FFDK, FFDHK, FFDHLK	294 kW		07/06→	Left	9HB 863 839-001	178
35.400 FFDH-TM	294 kW		07/06→		Cover, wide angle mirror	
35.400 FFNHLK	294 kW		11/06→			
35.400 FFNLC	294 kW		07/06→	Right	9HB 863 840-001	178
35.410 FDNLC	301 kW		07/06→		Cover, wide angle mirror	
35.410 FFDK	301 kW		07/06→	Fulfills ECE norm.: 2003/38 / 2003/97; Heatable / for electric mirror adjustment; 24 V	9MX 564 249-001	Mirror 186
35.410 FFDC, FFDLC	301 kW		10/03→		Glass, outside mirror	
35.410 FFDK, FFDLK	301 kW		10/03→	Right; Heatable / for electric mirror adjustment; 24 V	9MX 863 838-001	Mirror 187
35.410 FFD-TM	301 kW		11/03→		Glass, outside mirror	
35.410 FFNLC	301 kW		07/06→	Fulfills ECE norm.: 2003/38 / 2003/97; Heatable / for electric mirror adjustment; 24 V	9MX 863 839-011	Mirror 190
35.430, 35.440 FFDC, FFDRC, FFDLC	316 - 324 kW		02/04→		Glass, wide angle mirror	
35.430, 35.440 FFDK, FFDRC, FFDLK	316 - 324 kW		02/04→	Fulfills ECE norm.: 2003/38 / 2003/97; Heatable / for electric mirror adjustment; 24 V	9MX 863 847-011	Mirror 188
35.430, 35.440 FFD-TM	316 - 324 kW		02/04→		Glass, ramp mirror	
35.430 FDNLC	316 kW		07/06→			
35.430 FFDK, FFDHK, FFDHLK	316 kW		07/06→			
35.430 FFDH-TM	316 kW		07/06→			
35.430 FFNLC	316 kW		07/06→			
35.440 FDNLC	324 kW		07/06→			
35.440 FFDK, FFDHK, FFDHLK	324 kW		07/06→			
35.440 FFDH-TM	324 kW		07/06→			
35.440 FFNHLK	324 kW		11/06→			
35.440 FFNLC	324 kW		07/06→			
35.460 FFDC, FFDLC	338 kW		10/03→			
35.460 FFDK, FFDLK	338 kW		10/03→			
35.460 FFD-TM	338 kW		11/03→			
35.460 FFNLC	338 kW		07/06→			
35.480 FDNLC	353 kW		07/06→			
35.480 FFDK	353 kW		07/06→			
35.480 FFDK, FFDHK, FFDHLK	353 kW		07/06→			
35.480 FFDARS	353 kW		07/06→			
35.480 FFDC, FFDLC	353 kW		10/03→			
35.480 FFDC, FFDLC	353 kW		02/04→			
35.480 FFDH-TM	353 kW		07/06→			
35.480 FFDK, FFDLK	353 kW		10/03→			
35.480 FFDK, FFDLK	353 kW		02/04→			
35.480 FFD-TM	353 kW		11/03→			
35.480 FFD-TM	353 kW		02/04→			
35.480 FFNHLK	353 kW		11/06→			
35.480 FFNLC	353 kW		07/06→			
35.530 FDNLC	390 kW		04/04→			
35.530 FFDK	390 kW		07/06→			
35.530 FFDC, FFDLC	390 kW		04/04→			
35.530 FFDK, FFDLK	390 kW		04/04→			
35.530 FFD-TM	390 kW		04/04→			
35.530 FFNLC	390 kW		07/06→			
37.310, 37.320 FFDC	228 - 235 kW		12/04→			
37.310, 37.320 FFDK	228 - 235 kW		12/04→			
37.310, 37.320 FFD-TM	228 - 235 kW		12/04→			
37.310 FFDC	228 kW		12/04→			
37.310 FFDK	228 kW		12/04→			
37.310 FFD-TM	228 kW		12/04→			
37.350, 37.360 FFDC	257 - 265 kW		12/04→			
37.350, 37.360 FFDK	257 - 265 kW		12/04→			
37.350, 37.360 FFD-TM	257 - 265 kW		12/04→			
37.360 FFDC	265 kW		12/04→			
37.360 FFDK	265 kW		12/04→			
37.360 FFD-TM	265 kW		12/04→			
37.390, 37.400 FFDC	287 - 294 kW		12/04→			
37.390, 37.400 FFDK	287 - 294 kW		12/04→			
37.390, 37.400 FFD-TM	287 - 294 kW		12/04→			
37.410 FFDC	301 kW		12/04→			
37.410 FFDK	301 kW		12/04→			
37.410 FFD-TM	301 kW		12/04→			
37.430, 37.440 FFDC	316 - 324 kW		12/04→			
37.430, 37.440 FFDK	316 - 324 kW		12/04→			
37.430, 37.440 FFD-TM	316 - 324 kW		12/04→			
37.460 FFDC	338 kW		12/04→			
37.460 FFDK	338 kW		12/04→			
37.460 FFD-TM	338 kW		12/04→			
37.480 FFDC	353 kW		12/04→			
37.480 FFDC	353 kW		02/06→			
37.480 FFDK	353 kW		12/04→			
37.480 FFDK	353 kW		02/06→			

Manufacturer - Model	Power	Displ.	Year of Constr.	Remark	Part Number	Page
MAN - TGA						04/00→
37.480 FFD-TM	353 kW		12/04→	Right; H 399 mm; Heatable / for electric mirror adjustment; 24 V; W 222 mm	8SB 354 504-021	166
37.480 FFD-TM	353 kW		02/06→		Outside Mirror	
37.530 FFDC	390 kW		12/04→	Right; Heatable / for electric mirror adjustment; 24 V	8SB 354 509-001	Ramp 181
37.530 FFDK	390 kW		12/04→		Mirror	
37.530 FFD-TM	390 kW		12/04→			
37.530 FVDS, FVDLS	390 kW		07/06→	Left	9HB 863 835-001	178
39.390 FVNLC	287 kW		07/06→		Cover, outside mirror	
39.400 FVNLC	294 kW		07/06→	Left	9HB 863 839-001	178
39.430 FVNLC	316 kW		07/06→		Cover, wide angle mirror	
39.440 FVNLC	324 kW		07/06→	Right	9HB 863 840-001	178
39.480 FVNLC	353 kW		07/06→		Cover, wide angle mirror	
40.390, 40.400 FDAK-WW	287 - 294 kW		06/05→	Fulfils ECE norm.: 2003/38 / 2003/97; Heatable / for electric mirror adjustment; 24 V	9MX 564 249-001	Mirror 186
40.390, 40.400 FDAS-WW	287 - 294 kW		06/05→		Glass, outside mirror	
40.390, 40.400 FDK-WW, FDRK	287 - 294 kW		06/05→	Right; Heatable / for electric mirror adjustment; 24 V	9MX 863 838-001	Mirror 187
40.390, 40.400 FDS-WW, FDRS	287 - 294 kW		06/05→		Glass, outside mirror	
40.410 FDAK-WW	301 kW		04/04→	Fulfils ECE norm.: 2003/38 / 2003/97; Heatable / for electric mirror adjustment; 24 V	9MX 863 839-011	Mirror 190
40.410 FDAS-WW	301 kW		04/04→		Glass, wide angle mirror	
40.410 FDK-WW	301 kW		04/04→			
40.410 FDS-WW	301 kW		04/04→	Fulfils ECE norm.: 2003/38 / 2003/97; Heatable / for electric mirror adjustment; 24 V	9MX 863 847-011	Mirror 188
40.430, 40.440 FDAK-WW	316 - 324 kW		06/05→		Glass, ramp mirror	
40.430, 40.440 FDAS-WW	316 - 324 kW		06/05→			
40.430 FDK-WW, FDRK	316 kW		06/05→			
40.430 FDS-WW, FDRS	316 kW		06/05→			
40.440 FDAK-WW	324 kW		06/05→			
40.440 FDAS-WW	324 kW		06/05→			
40.440 FDK-WW, FDRK	324 kW		06/05→			
40.440 FDS-WW, FDRS	324 kW		06/05→			
40.460 FDAK-WW	338 kW		04/04→			
40.460 FDAS-WW	338 kW		04/04→			
40.460 FDK-WW	338 kW		04/04→			
40.460 FDS-WW	338 kW		04/04→			
40.480 FDAK-WW	353 kW		04/04→			
40.480 FDK-WW	353 kW		06/05→			
40.480 FDAS-WW	353 kW		04/04→			
40.480 FDS-WW	353 kW		06/05→			
40.480 FDK-WW, FDRK	353 kW		04/04→			
40.480 FDS-WW, FDRS	353 kW		06/05→			
41.350, 41.360 FFDC, FFDC/M, FFDRK	257 - 265 kW		12/04→			
41.350, 41.360 FFD-TM	257 - 265 kW		12/04→			
41.350 FFDC-TM, FFDRK	257 kW		09/07→			
41.360 FFD	265 kW		12/08→			
41.360 FFDC, FFDC/M, FFDC/M-WW, FFDRK	265 kW		01/03→			
41.360 FFDC-TM, FDRK-TM	265 kW		09/07→			
41.360 FFDK-WW	265 kW		09/03→			
41.360 FFD-TM	265 kW		12/04→			
41.390, 41.400 FFDC, FFDRK, FFDC/M	287 - 294 kW		12/04→			
41.390, 41.400 FFDK, FFDRK	287 - 294 kW		12/04→			
41.390, 41.400 FFD-TM	287 - 294 kW		12/04→			
41.390 FFDAK	287 kW		12/04→			
41.390 FFDC-TM, FDRK-TM	287 kW		09/07→			
41.400 FFD	294 kW		12/08→			
41.400 FFDC-TM, FDRK-TM	294 kW		09/07→			
41.410 FFDAK	301 kW		07/06→			
41.410 FFDC-WW, FDRK	301 kW		09/03→			
41.410 FFDK-WW	301 kW		09/03→			
41.410 FFD-TM	301 kW		12/04→			
41.430, 41.440 FFDC, FFDRK, FFDC/M	316 - 324 kW		12/04→			
41.430, 41.440 FFDK, FFDRK	316 - 324 kW		12/04→			
41.430, 41.440 FFD-TM	316 - 324 kW		12/04→			
41.430 FFDAK	316 kW		12/04→			
41.430 FFDAK	316 kW		07/06→			
41.430 FFDC-TM, FFDRK	316 kW		09/07→			
41.440 FFD/M	324 kW		12/04→			
41.440 FFDAK	324 kW		07/06→			
41.440 FFDC, FFDRK	324 kW		12/04→			
41.440 FFDC-TM, FFDRK-TM	324 kW		09/07→			
41.440 FFDK, FFDRK	324 kW		12/04→			
41.460 FFDC-WW, FFDRK	338 kW		09/03→			
41.460 FFDK-WW	338 kW		09/03→			
41.460 FFD-TM	338 kW		12/04→			
41.480 FFD	353 kW		12/08→			
41.480 FFDAK	353 kW		07/06→			
41.480 FFDARC	353 kW		07/06→			
41.480 FFDC, FFDRK, FFDC/M	353 kW		02/06→			

Manufacturer - Model	Power	Displ.	Year of Constr.	Remark	Part Number	Page
MAN - TGA						04/00→
41.480 FFDC-TM, FFDRK	353 kW		09/07→	Right; H 399 mm; Heatable / for electric mirror adjustment; 24 V; W 222 mm	8SB 354 504-021 Outside Mirror	166
41.480 FFDC-WW, FFDRK	353 kW		06/05→			
41.480 FFDK, FFDRC	353 kW		02/06→	Right; Heatable / for electric mirror adjustment; 24 V	8SB 354 509-001 Ramp Mirror	181
41.480 FFDK-WW	353 kW		06/05→			
41.480 FFD-TM	353 kW		12/04→			
41.480 FFD-TM	353 kW		02/06→	Left	9HB 863 835-001 Cover, outside mirror	178
41.480 FVDS, FVDLS	353 kW		07/06→			
41.530 FFDK	353 kW		07/06→	Left	9HB 863 839-001 Cover, wide angle mirror	178
41.530 FFDK	390 kW		07/06→			
41.530 FFDC	390 kW		12/04→	Right	9HB 863 840-001 Cover, wide angle mirror	178
41.530 FFDK	390 kW		12/04→			
41.530 FFD-TM	390 kW		12/04→			
41.530 FVDS, FVDLS	390 kW		09/02→	Fulfils ECE norm.: 2003/38 / 2003/97; Heatable / for electric mirror adjustment; 24 V	9MX 564 249-001 Mirror Glass, outside mirror	186
41.540 FVDS, FVDLS	397 kW		11/06→	Right; Heatable / for electric mirror adjustment; 24 V	9MX 863 838-001 Mirror Glass, outside mirror	187
41.660 FVDS, FVDLS	485 kW		09/02→			
				Fulfils ECE norm.: 2003/38 / 2003/97; Heatable / for electric mirror adjustment; 24 V	9MX 863 839-011 Mirror Glass, wide angle mirror	190
				Fulfils ECE norm.: 2003/38 / 2003/97; Heatable / for electric mirror adjustment; 24 V	9MX 863 847-011 Mirror Glass, ramp mirror	188
MAN - TGL						04/05→
10.180 FC, FRC, FLC, FLRC	132 kW		04/05→	Right; H 399 mm; Heatable / for electric mirror adjustment; 24 V; W 222 mm	8SB 354 504-021 Outside Mirror	166
10.180 FK, FRK	132 kW		04/05→			
10.210 FC, FRC, FLC, FLRC	151 kW		04/05→	Right; Heatable / for electric mirror adjustment; 24 V	8SB 354 509-001 Ramp Mirror	181
10.210 FK, FRK	151 kW		04/05→			
10.220 FC, FLC, FRC, FLRC	162 kW		04/05→	Left	9HB 863 835-001 Cover, outside mirror	178
10.220 FK, FRK	162 kW		04/05→			
10.240 FC, FRC, FLC, FLRC	176 kW		04/05→	Left	9HB 863 839-001 Cover, wide angle mirror	178
10.240 FK, FRK	176 kW		04/05→			
10.250 FC, FLC, FRC, FLRC	184 kW		04/05→	Right	9HB 863 840-001 Cover, wide angle mirror	178
10.250 FK, FRK	184 kW		04/05→			
12.180 FC, FRC, FLC, FLRC	132 kW		04/05→			
12.180 FK, FRK	132 kW		04/05→			
12.210 FC, FRC, FLC, FLRC	151 kW		04/05→	Fulfils ECE norm.: 2003/38 / 2003/97; Heatable / for electric mirror adjustment; 24 V	9MX 564 249-001 Mirror Glass, outside mirror	186
12.210 FK, FRK	151 kW		04/05→			
12.220 FC, FRC, FLC, FLRC	162 kW		04/05→	Right; Heatable / for electric mirror adjustment; 24 V	9MX 863 838-001 Mirror Glass, outside mirror	187
12.220 FK, FRK	162 kW		04/05→			
12.240 FC, FRC, FLC, FLRC	176 kW		04/05→	Fulfils ECE norm.: 2003/38 / 2003/97; Heatable / for electric mirror adjustment; 24 V	9MX 863 839-011 Mirror Glass, wide angle mirror	190
12.240 FK, FRK	176 kW		04/05→			
12.250 FC, FLC, FRC, FLRC	184 kW		04/05→	Fulfils ECE norm.: 2003/38 / 2003/97; Heatable / for electric mirror adjustment; 24 V	9MX 863 847-011 Mirror Glass, ramp mirror	188
12.250 FK, FRK	184 kW		04/05→			
7.150, 8.150 FC, FRC, FLC, FLRC	110 kW		04/05→			
7.180 FC, FLC, FRC, FLRC	132 kW		04/05→			
7.220 FC, FLC, FRC, FLRC	162 kW		04/05→			
7.250 FC, FLC, FRC, FLRC	184 kW		04/05→			
8.150 FK, FRK, FK-L, FRK-L	110 kW		10/06→			
8.180 FC, FRC, FLC, FLRC	132 kW		04/05→			
8.180 FK, FK-L, FRK, FRK-L	132 kW		04/05→			
8.210 FC, FRC, FLC, FLRC	151 kW		04/05→			
8.210 FK, FK-L, FRK, FRK-L	151 kW		04/05→			
8.220 FC, FLC, FRC, FLRC	162 kW		04/05→			
8.220 FK, FRK, FK-L, FRK-L	162 kW		04/05→			
8.240 FC, FRC, FLC, FLRC	176 kW		04/05→			
8.240 FK, FK-L, FRK, FRK-L	176 kW		04/05→			
8.250 FC, FLC, FLRC, FRC	184 kW		04/05→			
8.250 FK, FK-L, FRK, FRK-L	184 kW		04/05→			
MAN - TGM						10/05→
12.240 FLC, FLLC	176 kW		10/05→	Right; H 399 mm; Heatable / for electric mirror adjustment; 24 V; W 222 mm	8SB 354 504-021 Outside Mirror	166
12.250 FLC, FLLC	184 kW		10/05→			
12.280 FC, FLC, FLLC	206 kW		10/05→	Right; Heatable / for electric mirror adjustment; 24 V	8SB 354 509-001 Ramp Mirror	181
12.290 FLC, FLLC	213 kW		10/05→			
13.240 FAL, FALC, FALRC, FAEC, FAERC, FALR	176 kW		04/06→	Left	9HB 863 835-001 Cover, outside mirror	178
13.240 FALK, FALRK, FALK-L, FALRK-L	176 kW		04/06→	Left	9HB 863 839-001 Cover, wide angle mirror	178
13.250 FAEC, FAERC, FALC, FAL, FALRC, FALR	184 kW		10/05→	Right	9HB 863 840-001 Cover, wide angle mirror	178
13.250 FALK, FALRK, FALK-L, FALRK-L	184 kW		10/05→			
13.280 FAEC, FAERC, FAL, FALC, FALRC	206 kW		04/06→	Fulfils ECE norm.: 2003/38 / 2003/97; Heatable / for electric mirror adjustment; 24 V	9MX 564 249-001 Mirror Glass, outside mirror	186
13.280 FALK, FALRK, FALK-L, FALRK-L	206 kW		04/06→	Right; Heatable / for electric mirror adjustment; 24 V	9MX 863 838-001 Mirror Glass, outside mirror	187
13.290 FAEC, FAERC, FAL, FALR, FALC, FALRC	213 kW		10/05→	Fulfils ECE norm.: 2003/38 / 2003/97; Heatable / for electric mirror adjustment; 24 V	9MX 863 839-011 Mirror Glass, wide angle mirror	190
13.290 FALK, FALRK, FALK-L, FALRK-L	213 kW		10/05→	Fulfils ECE norm.: 2003/38 / 2003/97; Heatable / for electric mirror adjustment; 24 V	9MX 863 847-011 Mirror Glass, ramp mirror	188

Manufacturer - Model	Power	Displ.	Year of Constr.	Remark	Part Number	Page
MAN - TGM						10/05→
15.240 FC, FLC, FLLC, FLRC, FLLRC	176 kW		10/05→	Right; H 399 mm; Heatable / for electric mirror adjustment; 24 V; W 222 mm	8SB 354 504-021 Outside Mirror	166
15.240 FLK, FLRK	176 kW		10/05→			
15.250 FC, FLC, FLRC, FLLC, FLLRC	184 kW		10/05→	Right; Heatable / for electric mirror adjustment; 24 V	8SB 354 509-001 Mirror	Ramp 181
15.250 FLK, FLRK	184 kW		10/05→	Left	9HB 863 835-001 Cover, outside mirror	178
15.280 FC, FLC, FLLC, FLRC, FLLRC	206 kW		10/05→	Left	9HB 863 839-001 Cover, wide angle mirror	178
15.280 FLK, FLRK	206 kW		10/05→			
15.290 FC, FLC, FLRC, FLLC, FLLRC	213 kW		10/05→	Right	9HB 863 840-001 Cover, wide angle mirror	178
15.290 FLK, FLRK	213 kW		10/05→	Fulfils ECE norm.: 2003/38 / 2003/97; Heatable / for electric mirror adjustment; 24 V	9MX 564 249-001 Mirror	186
15.330 FC, FLC, FRC, FLRC	240 kW		10/05→		9MX 863 838-001 Glass, outside mirror	187
15.330 FLK, FLRK	240 kW		10/05→	Right; Heatable / for electric mirror adjustment; 24 V	9MX 863 838-001 Glass, outside mirror	187
15.340 FC, FLC, FLRC	250 kW		10/05→			
15.340 FLK, FLRK	250 kW		10/05→	Fulfils ECE norm.: 2003/38 / 2003/97; Heatable / for electric mirror adjustment; 24 V	9MX 863 839-011 Mirror	190
18.240 FAC, FARC	176 kW		10/05→		9MX 863 847-011 Glass, wide angle mirror	188
18.240 FC, FRC, FLC, FLRC, FLLC, FLLRC	176 kW		10/05→	Fulfils ECE norm.: 2003/38 / 2003/97; Heatable / for electric mirror adjustment; 24 V	9MX 863 847-011 Mirror	188
18.240 FK, FRK, FLK, FK-L, FLRK	176 kW		10/05→			
18.250 FAC, FARC	184 kW		10/05→			
18.250 FAK, FARK, FAK-L, FARK-L	184 kW		10/05→			
18.250 FC, FLC, FLLC, FRC, FLRC, FLLRC	184 kW		10/05→			
18.250 FK, FLK, FRK, FLRK	184 kW		10/05→			
18.280 FAC, FARC	206 kW		10/05→			
18.280 FAK, FARK, FAK-L, FARK-L	206 kW		10/05→			
18.280 FC, FRC, FLC, FLRC, FLLC, FLLRC	206 kW		10/05→			
18.280 FK, FLK, FRK, FLRK, FK-L	206 kW		10/05→			
18.290 FAC, FARC	213 kW		10/05→			
18.290 FAK, FARK, FAK-L, FARK-L	213 kW		10/05→			
18.290 FC, FLC, FRC, FLRC, FLLC, FLLRC	213 kW		10/05→			
18.290 FK, FLK, FRK, FLRK	213 kW		10/05→			
18.330 FAC, FARC	240 kW		10/05→			
18.330 FAK, FARK, FAK-L, FARK, L	240 kW		10/05→			
18.330 FC, FRC, FLC, FLRC, FLLC, FLLRC	240 kW		10/05→			
18.330 FK, FLK, FRK, FLRK, FK-L	240 kW		10/05→			
18.340 FAC, FARC	250 kW		10/05→			
18.340 FAK, FARK, FAK-L, FARK-L	250 kW		10/05→			
18.340 FC, FLC, FLRC, FLLC, FLLRC, FRC	250 kW		10/05→			
18.340 FK, FRK, FLK, FLRK	250 kW		10/05→			
22.240 FNLLC	176 kW		10/05→			
22.250 FNLLC	184 kW		10/05→			
22.280 FNL, 22.280 FNLLC	206 kW		10/05→			
22.290 FNL, 22.290 FNLLC	213 kW		10/05→			
26.280 FD	206 kW		10/05→			
26.280 FDK-HK, FDRK-HK	206 kW		04/06→			
26.280 FD-TM, FDR-TM	206 kW		04/06→			
26.280 FNLC, FNLLC, FNLRC, FNLLRC	206 kW		10/05→			
26.290 FD, FDR	213 kW		10/05→			
26.290 FDK-HK, FDRK-HK	213 kW		10/05→			
26.290 FNLC, FNLLC, FNLRC, FNLLRC, FVL	213 kW		10/05→			
26.330 FD, FDR	240 kW		10/05→			
26.330 FDK-HK, FDRK-HK	240 kW		04/06→			
26.330 FD-TM, FDR-TM	240 kW		04/06→			
26.330 FNLC, FNLLC, FNLRC, FNLLRC, FVL	240 kW		10/05→			
26.340 FD, FDR	250 kW		10/05→			
26.340 FDK-HK, FDRK-HK	250 kW		10/05→			
26.340 FNLC, FNLLC, FNLRC, FNLLRC	250 kW		10/05→			
MAN - ÜL						09/96→
ÜL 313	228 kW		09/96→	Right; H 551 mm; W 661 mm	8SB 501 246-812 Outside Mirror	169
ÜL 353	257 kW		06/97→			

8HG ...

8HG 503 009-022	180
8HG 503 009-082	180
8HG 503 019-012	180
8HG 503 019-022	181

8KA ...

8KA 500 218-002	179
8KA 560 271-002	179

8SB ...

8SB 354 504-021	166
8SB 354 509-001	181
8SB 501 137-001	166
8SB 501 137-031	167
8SB 501 147-021	182
8SB 501 147-031	182
8SB 501 156-021	167
8SB 501 156-031	168
8SB 501 246-812	169
8SB 501 246-892	170
8SB 501 247-803	171
8SB 501 325-002	172
8SB 501 325-012	173
8SB 501 325-032	174
8SB 560 991-012	175
8SB 560 991-041	176
8SB 560 991-061	177

9EY ...

9EY 120 010-001	183
9EY 561 042-002	183
9EY 561 814-001	189

9HB ...

9HB 863 835-001	178
9HB 863 839-001	178
9HB 863 840-001	178

9HD ...

9HD 563 475-041	178
-----------------	-----

9MX ...

9MX 561 044-002	184
9MX 561 890-001	189
9MX 561 891-001	184
9MX 563 468-002	185
9MX 564 249-001	186
9MX 863 838-001	187
9MX 863 839-011	190
9MX 863 847-011	188



Cap, fuel tank.....	223
---------------------	-----

Lid - Cap, fuel tank

8XY 004 734-001
089722, LT 1

(metal ***) _



Inner Diameter [mm]	78
Lock System	<ul style="list-style-type: none"> • with lock • with key
Material	Metal
Outer Diameter 1 [mm]	115
Supplementary Article/Supplementary Info 2	<ul style="list-style-type: none"> • without support strap • with breather valve
SVHC	117-81-7; Bis (2-ethylhex-yl)phthalate (DEHP)

8XY 007 023-001
LT 3, 089766

(plastic, black)

Colour	Black
Inner Diameter [mm]	78
Lock System	without lock
Material	Plastic
Outer Diameter 1 [mm]	115
Supplementary Article/Supplementary Info 2	<ul style="list-style-type: none"> • without support strap • with breather valve



MAN.....225

Manufacturer - Model	Power	Displ.	Year of Constr.	Remark	Part Number	Page
MAN - Cab-over Trucks					07/86→05/94	
19.322 U, 19.322 UL, 19.322 ULL	235 kW		02/90→05/94	Inner Diameter [mm]: 78; with lock / with key	8XY 004 734-001 Cap, fuel tank	223
19.332 U, 19.322 UL, 19.322 ULL	243 kW		07/86→02/90			
19.362 U, 19.362 UL, 19.362 ULL	265 kW		07/86→01/91	Inner Diameter [mm]: 78; without lock; without support strap / with breather valve	8XY 007 023-001 Cap, fuel tank	223
19.372 U, 19.372 ULL	272 kW		02/90→05/94			
19.422 U, 19.422 ULL	309 kW		02/90→05/94			
24.322 UNL, 24.322 UNLL	235 kW		02/90→12/90			
24.332 UNL, 24.332 UNLL	243 kW		10/86→02/90			
24.362 UNL, 24.362 UNLL	265 kW		10/86→02/90			
24.372 UNL, 24.372 UNLL	272 kW		02/90→12/90			
24.422 UNL, 24.422 UNLL	309 kW		02/90→12/90			
25.322 UNL, 25.322 UNLL	235 kW		09/90→12/92			
25.372 UNL, 25.372 UNLL	272 kW		09/90→12/92			
25.422 UNL, 25.422 UNLL	309 kW		09/90→12/92			
26.322 UNL, 26.322 UNLL	235 kW		09/90→05/94			
26.372 UNL, 26.372 UNLL	272 kW		09/90→05/94			
26.422 UNL, 26.422 UNLL	309 kW		09/90→05/94			
MAN - F 9					01/83→12/86	
15.192 F, 15.192 FL	141 kW		01/83→12/86	Inner Diameter [mm]: 78; with lock / with key	8XY 004 734-001 Cap, fuel tank	223
15.192 FS	141 kW		01/83→12/86			
				Inner Diameter [mm]: 78; without lock; without support strap / with breather valve	8XY 007 023-001 Cap, fuel tank	223
MAN - F 90					07/86→	
15.192 FL	141 kW			Inner Diameter [mm]: 78; with lock / with key	8XY 004 734-001 Cap, fuel tank	223
19.242 F, 19.242 FL, 19.242 FLL	177 kW		01/88→01/89			
19.242 FK	177 kW		01/88→02/89	Inner Diameter [mm]: 78; without lock; without support strap / with breather valve	8XY 007 023-001 Cap, fuel tank	223
19.242 FS, 19.242 FLS, 19.242 FLLS	177 kW		01/88→01/89			
19.262 F, 19.262 FL, 19.262 FLL	191 kW		01/88→02/90			
19.262 FA	191 kW		02/89→02/90			
19.262 FAK	191 kW		02/89→02/90			
19.262 FAS	191 kW		02/89→02/90			
19.262 FK	191 kW		01/88→02/90			
19.262 FS, 19.262 FLS, 19.262 FLLS	191 kW		01/88→02/90			
19.272 F, 19.272 FL, 19.272 FLL	198 kW		02/90→05/95			
19.272 FA	198 kW		02/90→05/95			
19.272 FAK	198 kW		02/90→05/95			
19.272 FAS	198 kW		02/90→05/95			
19.272 FK	198 kW		02/90→05/95			
19.272 FS, 19.272 FLS, 19.272 FLLS	198 kW		02/90→05/95			
19.292 F, 19.292 FL, 19.292 FLL	213 kW		07/86→02/90			
19.292 FA	213 kW		05/88→02/90			
19.292 FAK	213 kW		05/88→02/90			
19.292 FAS	213 kW		05/88→02/90			
19.292 FK	213 kW		07/86→02/90			
19.292 FS, 19.292 FLS, 19.292 FLLS	213 kW		07/86→02/90			
19.322 F, 19.322 FL, 19.322 FLL	235 kW		02/90→05/95			
19.322 FA	235 kW		02/90→06/96			
19.322 FAK	235 kW		02/90→06/96			
19.322 FAS	235 kW		02/90→06/96			
19.322 FK	235 kW		02/90→05/95			
19.322 FS, 19.322 FLS, 19.322 FLLS	235 kW		02/90→05/95			
19.332 F, 19.332 FL, 19.332 FLL	243 kW		07/86→02/90			
19.332 FA	243 kW		05/88→02/90			
19.332 FAK	243 kW		05/88→02/90			
19.332 FAS	243 kW		05/88→02/90			
19.332 FK	243 kW		07/86→02/90			
19.332 FS, 19.332 FLS, 19.332 FLLS	243 kW		07/86→02/90			
19.342 F, 19.342 FL, 19.342 FLL	250 kW		05/94→05/95			
19.342 FA	250 kW		05/94→06/96			
19.342 FAK	250 kW		05/94→06/96			
19.342 FAS	250 kW		05/94→06/96			
19.342 FK	250 kW		05/94→05/95			
19.342 FS, 19.342 FLS, 19.342 FLLS	250 kW		05/94→05/95			
19.362 F, 19.362 FL, 19.362 FLL	265 kW		07/86→02/90			
19.362 FA	265 kW		05/88→02/90			
19.362 FAK	265 kW		05/88→02/90			
19.362 FAS	265 kW		05/88→02/90			
19.362 FK	265 kW		07/86→02/90			
19.372 F, 19.372 FL, 19.372 FLL	249 kW		05/90→04/95			
19.372 F, 19.372 FL, 19.372 FLL	272 kW		02/90→05/95			
19.372 FA	272 kW		02/90→06/96			
19.372 FAK	272 kW		02/90→06/96			

Manufacturer - Model	Power	Displ.	Year of Constr.	Remark	Part Number	Page
MAN - F 90						07/86→
19.372 FAS	272 kW		02/90→06/96	Inner Diameter [mm]: 78; with lock / with key	8XY 004 734-001 Cap, fuel tank	223
19.372 FK	249 kW		05/90→04/95			
19.372 FK	272 kW		02/90→05/95	Inner Diameter [mm]: 78; without lock; without support strap / with breather valve	8XY 007 023-001 Cap, fuel tank	223
19.372 FS,19.372 FLS,19.372 FLLS	249 kW		05/90→04/95			
19.372 FS,19.372 FLS,19.372 FLLS	272 kW		02/90→05/95			
19.402 F,19.402 FL,19.402 FLL	294 kW		05/94→05/95			
19.402 FA	294 kW		05/94→06/96			
19.402 FAK	294 kW		05/94→06/96			
19.402 FAS	294 kW		05/94→06/96			
19.402 FK	294 kW		05/94→05/95			
19.402 FS,19.402 FLS,19.402 FLLS	294 kW		05/94→05/95			
19.422 F,19.422 FL,19.422 FLL	309 kW		02/90→05/95			
19.422 FA	309 kW		02/90→06/96			
19.422 FAK	309 kW		02/90→06/96			
19.422 FAS	309 kW		02/90→06/96			
19.422 FK	309 kW		02/90→05/95			
19.422 FS,19.422 FLS,19.422 FLLS	309 kW		02/90→05/95			
19.462 F,19.462 FL	338 kW		05/87→02/90			
19.462 FK	338 kW		05/87→02/90			
19.462 FS,19.462 FLS	338 kW		05/87→02/90			
19.502 F,19.502 FL,19.502 FLL	368 kW		02/90→06/96			
19.502 FS,19.502 FLS,19.502 FLLS	368 kW		02/90→06/96			
24.242 DF	177 kW		01/88→07/89			
24.242 DFK	177 kW		01/88→07/89			
24.242 DFS	177 kW		01/88→07/89			
24.242 FNL,24.242 FNLL,24.242 FVL	177 kW		01/88→02/90			
24.262 DF	191 kW		01/88→02/90			
24.262 DFK	191 kW		01/88→02/90			
24.262 DFS,24.262 DFSL	191 kW		01/88→02/90			
24.262 FNL,24.262 FNLL,24.262 FVL	191 kW		01/88→02/90			
24.272 DF	198 kW		02/90→12/90			
24.272 DFK	198 kW		02/90→12/90			
24.272 DFS,24.272 DFSL	198 kW		02/90→04/95			
24.272 FNL,24.272 FNLL,24.272 FVL	198 kW		02/90→05/95			
24.272 FNLS,24.272 FVLS	198 kW		02/90→05/95			
24.292 DF	213 kW		04/87→02/90			
24.292 DFK	213 kW		04/87→02/90			
24.292 DFS,24.292 DFSL	213 kW		04/87→02/90			
24.292 FNL,24.292 FNLL,24.292 FVL	213 kW		10/86→02/90			
24.292 FNLS,24.292 FVLS	213 kW		10/86→02/90			
24.302 DF	220 kW		05/90→12/90			
24.302 DFK	220 kW		05/90→12/90			
24.302 DFS,24.302 DFSL	220 kW		05/90→04/95			
24.302 FNL,24.302 FNLL,24.302 FVL	220 kW		05/90→10/90			
24.322 DF	235 kW		02/90→12/90			
24.322 DFK	235 kW		02/90→12/90			
24.322 DFS,24.322 DFSL	235 kW		02/90→12/90			
24.322 FNL,24.322 FNLL,24.322 FVL	235 kW		02/90→05/95			
24.322 FNLS,24.322 FVLS	235 kW		02/90→05/95			
24.332 DF	243 kW		04/87→02/90			
24.332 DFK	243 kW		04/87→02/90			
24.332 DFS,24.332 DFSL	243 kW		04/87→02/90			
24.332 FNL,24.332 FNLL,24.332 FVL	243 kW		10/86→02/90			
24.332 FNLS,24.332 FVLS	243 kW		10/86→02/90			
24.342 FNL,24.342 FNLL	250 kW		05/94→05/95			
24.362 DF	265 kW		04/87→02/90			
24.362 DFK	265 kW		04/87→02/90			
24.362 DFS,24.362 DFSL	265 kW		04/87→02/90			
24.362 FNL,24.362 FNLL,24.362 FVL	265 kW		10/86→02/90			
24.362 FNLS,24.362 FVLS	265 kW		10/86→02/90			
24.372 DF	249 kW		05/90→12/90			
24.372 DFK	272 kW		02/90→12/90			
24.372 DFL	249 kW		05/90→12/90			
24.372 DFS	272 kW		02/90→12/90			
24.372 DFSL	249 kW		05/90→12/90			
24.372 DFS,24.372 DFSL	272 kW		02/90→04/95			
24.372 FNL,24.372 FNLL,24.372 FVL	272 kW		02/90→05/95			

Manufacturer - Model	Power	Displ.	Year of Constr.	Remark	Part Number	Page
MAN - F 90						07/86→
24.372 FNLS,24.372 FVLS	272 kW		02/90→05/95	Inner Diameter [mm]: 78; with lock / with key	8XY 004 734-001 Cap, fuel tank	223
24.372 FVL	249 kW		05/90→12/90			
24.372 FVLS	249 kW		05/90→12/90	Inner Diameter [mm]: 78; without lock; without support strap / with breather valve	8XY 007 023-001 Cap, fuel tank	223
24.402 FNL,24.402 FNLL	294 kW		05/94→05/95			
24.422 DF	309 kW		02/90→12/90			
24.422 DFK	309 kW		02/90→12/90			
24.422 DFS,24.422 DFSL	309 kW		02/90→12/90			
24.422 FNL,24.422 FNLL,24.422 FVL	309 kW		02/90→05/95			
24.462 DF	338 kW		02/89→02/90			
24.462 DFS	338 kW		02/89→02/90			
24.462 FNL	338 kW		04/89→02/90			
24.462 FVLS	338 kW		05/87→07/87			
24.502 DF	368 kW		02/90→12/90			
24.502 DFK	368 kW		02/90→12/90			
24.502 DFS	368 kW		02/90→12/90			
24.502 FNL	368 kW		02/90→12/90			
25.272 DF	198 kW		09/90→12/92			
25.272 DFK	198 kW		09/90→12/92			
25.272 DFS,25.272 DFSL	198 kW		09/90→12/92			
25.272 FNL,25.272 FNLL,25.272 FVL	198 kW		09/90→10/93			
25.302 DF	220 kW		09/90→12/91			
25.302 DFK	220 kW		09/90→12/91			
25.302 DFS, 25.302 DFSL	220 kW		09/90→12/91			
25.302 FNL, 25.302 FNLL, 25.302 FVL	220 kW		09/90→12/91			
25.302 FNLS, 25.302 FVLS	220 kW		09/90→12/91			
25.322 DF, 25.322 DFL	235 kW		09/90→12/92			
25.322 DFK	235 kW		09/90→12/92			
25.322 DFS, 25.322 DFSL	235 kW		09/90→12/92			
25.322 FNL, 25.322 FNLL, 25.322 FVL	235 kW		09/90→12/92			
25.322 FNLS,25.322 FVLS	235 kW		09/90→12/92			
25.372 DF	249 kW		09/90→12/92			
25.372 DF	272 kW		09/90→12/92			
25.372 DFK	249 kW		09/90→12/92			
25.372 DFK	272 kW		09/90→12/92			
25.372 DFS	249 kW		09/90→12/92			
25.372 DFS,25.372 DFSL	272 kW		09/90→12/92			
25.372 FNL, 25.372 FNLL, 25.372 FVL	272 kW		09/90→12/92			
25.372 FNLS,25.372 FVLS	272 kW		09/90→10/93			
25.372 FVLS	249 kW		09/90→10/93			
25.422 DF	309 kW		09/90→12/92			
25.422 DFK	309 kW		09/90→12/92			
25.422 DFS,25.422 DFSL	309 kW		09/90→12/92			
25.422 FNL,25.422 FNLL	309 kW		09/90→12/92			
25.422 FNLS,25.422 FVLS	309 kW		09/90→12/92			
25.502 DF	368 kW		09/90→12/92			
25.502 DFS	368 kW		09/90→12/92			
25.502 FNL	368 kW		09/90→12/92			
26.242 DF	177 kW		01/88→07/89			
26.242 DFAK	177 kW		02/89→07/89			
26.242 DFK	177 kW		01/88→07/89			
26.242 DFS	177 kW		01/88→07/89			
26.262 DF	191 kW		01/88→02/90			
26.262 DFA	191 kW		02/89→02/90			
26.262 DFAK	191 kW		02/89→02/90			
26.262 DFAS	191 kW		02/89→02/90			
26.262 DFK	191 kW		01/88→02/90			
26.262 DFS	191 kW		01/88→02/90			
26.272 DF	198 kW		02/90→06/96			
26.272 DFA	198 kW		02/90→12/92			
26.272 DFAK	198 kW		02/90→12/92			
26.272 DFAS	198 kW		02/90→12/92			
26.272 DFK	198 kW		02/90→06/96			
26.272 DFS,26.272 DFSL	198 kW		02/90→06/96			
26.272 FNL,26.272 FNLL	198 kW		03/91→05/95			
26.272 FNLS,26.272 FVLS	198 kW		09/90→12/95			
26.292 DF, 26.292 DFL	213 kW		09/87→02/90			
26.292 DFA	213 kW		05/88→02/90			
26.292 DFAK	213 kW		05/88→02/90			
26.292 DFAS	213 kW		05/88→02/90			
26.292 DFK	213 kW		09/87→02/90			
26.292 DFS	213 kW		09/87→02/90			
26.302 DF	220 kW		05/90→12/91			
26.302 DFA	220 kW		05/90→12/91			
26.302 DFAK	220 kW		05/90→12/91			
26.302 DFAS	220 kW		05/90→12/91			
26.302 DFK	220 kW		05/90→12/91			

Manufacturer - Model	Power	Displ.	Year of Constr.	Remark	Part Number	Page
MAN - F 90						07/86→
26.302 DFS	220 kW		05/90→12/91	Inner Diameter [mm]: 78; with lock / with key	8XY 004 734-001 Cap, fuel tank	223
26.302 FNL, 26.302 FNLL, 26.302 FVL	220 kW		03/91→12/91			
26.302 FNLS,26.302 FVLS	220 kW		09/90→12/91	Inner Diameter [mm]: 78; without lock; without support strap / with breather valve	8XY 007 023-001 Cap, fuel tank	223
26.322 DF	235 kW		02/90→06/96			
26.322 DFA	235 kW		02/90→12/92			
26.322 DFAK	235 kW		02/90→12/92			
26.322 DFAS	235 kW		02/90→12/92			
26.322 DFK	235 kW		02/92→06/96			
26.322 DFS,26.322 DFLS	235 kW		02/90→06/96			
26.322 FNL,26.322 FNLL	235 kW		03/91→05/95			
26.322 FNLS,26.322 FVLS	235 kW		09/90→12/95			
26.332 DF, 26.332 DFL	243 kW		09/87→02/90			
26.332 DFA	243 kW		05/88→02/90			
26.332 DFAK	243 kW		05/88→02/90			
26.332 DFAS	243 kW		05/88→02/90			
26.332 DFK	243 kW		09/87→02/90			
26.332 DFS	243 kW		09/87→02/90			
26.342 DF,26.342 DFL	250 kW		05/94→06/96			
26.342 DFK,26.342 DFLK	250 kW		05/94→06/96			
26.342 DFS	250 kW		04/94→06/96			
26.362 DF, 26.362 DFL	265 kW		09/87→02/90			
26.362 DFA	265 kW		05/88→02/90			
26.362 DFAK	265 kW		05/88→02/90			
26.362 DFAS	265 kW		05/88→02/90			
26.362 DFK	265 kW		09/87→02/90			
26.362 DFS	265 kW		09/87→02/90			
26.372 DF,26.372 DFL	272 kW		02/90→06/96			
26.372 DFA	272 kW		02/90→12/92			
26.372 DFAK	272 kW		01/92→06/96			
26.372 DFAS	272 kW		02/90→12/92			
26.372 DFK	272 kW		01/92→06/96			
26.372 DFS	272 kW		02/90→06/96			
26.372 FNL,26.372 FNLL,26.372 FVL	272 kW		09/90→12/95			
26.372 FNLS,26.372 FVLS	272 kW		01/92→06/96			
26.402 DF,26.402 DFL	294 kW		05/94→06/96			
26.402 DFK,26.402 DFLK	294 kW		05/94→06/96			
26.402 DFS	294 kW		05/94→12/95			
26.402 FNL,26.402 FNLL,26.402 FVL	294 kW		05/94→06/96			
26.402 FNLS,26.402 FVLS	294 kW		05/94→06/96			
26.422 DF,26.422 DFL	309 kW		02/90→06/96			
26.422 DFA	309 kW		02/90→12/92			
26.422 DFAK	309 kW		02/90→12/92			
26.422 DFAS	309 kW		02/90→12/92			
26.422 DFK	309 kW		02/90→12/95			
26.422 DFS	309 kW		02/90→12/95			
26.422 FNL,26.422 FNLL,26.422 FVL	309 kW		09/90→12/95			
26.422 FNLS,26.422 FVLS	309 kW		01/92→12/95			
26.462 DF	338 kW		02/89→02/90			
26.462 DFA	338 kW		08/89→02/90			
26.462 DFAS	338 kW		08/89→02/90			
26.462 DFS	338 kW		02/89→02/90			
26.502 DF	368 kW		02/90→06/96			
26.502 DFA	368 kW		02/90→12/92			
26.502 DFAS	368 kW		02/90→12/92			
26.502 DFS,26.502 DFLS	368 kW		02/90→06/96			
26.502 FNL,26.502 FNLL	368 kW		09/91→06/96			
32.262 VF	191 kW		02/89→02/90			
32.262 VFK	191 kW		02/89→02/90			
32.262 VFTM	191 kW		02/89→02/90			
32.272 VF	198 kW		02/90→04/95			
32.272 VFK	198 kW		02/90→04/95			
32.292 VF	213 kW		03/88→02/90			
32.292 VFK	213 kW		03/88→02/90			
32.302 VF	220 kW		05/90→09/91			
32.302 VFK	220 kW		05/90→09/91			
32.322 VF	235 kW		02/90→06/96			
32.322 VFK	235 kW		02/90→06/96			
32.332 VF	243 kW		03/88→02/90			
32.332 VFK	243 kW		03/88→02/90			
32.342 VFK	250 kW		05/94→06/96			
32.362 VF	265 kW		03/88→02/90			
32.362 VFK	265 kW		03/88→02/90			
32.372 VF	249 kW		02/90→06/96			
32.372 VFK	272 kW		02/90→06/96			
32.372 VFK	249 kW		05/90→04/95			
32.372 VFK	272 kW		02/90→06/96			
32.402 VFK	294 kW		05/94→06/96			

Manufacturer - Model	Power	Displ.	Year of Constr.	Remark	Part Number	Page
MAN - F 90						07/86→
32.422 VF	309 kW		02/90→06/96	Inner Diameter [mm]: 78; with lock / with key	8XY 004 734-001 Cap, fuel tank	223
32.422 VFK	309 kW		02/90→06/96			
33.242 DFAK	177 kW		01/88→08/88	Inner Diameter [mm]: 78; without lock; without support strap / with breather valve	8XY 007 023-001 Cap, fuel tank	223
33.242 DFK	177 kW		01/88→08/88			
33.262 DF	191 kW		08/88→02/90			
33.262 DFA	191 kW		07/89→02/90			
33.262 DFAK	191 kW		07/89→02/90			
33.262 DFK	191 kW		08/88→02/90			
33.272 DF	198 kW		10/92→04/95			
33.272 DFA	198 kW		10/92→04/95			
33.272 FVL	191 - 198 kW		10/92→04/95			
33.292 DF	213 kW		09/87→02/90			
33.292 DFA	213 kW		05/88→02/90			
33.292 DFAK	213 kW		05/88→02/90			
33.292 DFAS	213 kW		05/88→02/90			
33.292 DFK	213 kW		09/87→02/90			
33.292 DFS	213 kW		09/87→02/90			
33.322 DF	235 kW		09/91→06/96			
33.322 DFA	235 kW		09/91→06/96			
33.322 FVL	235 kW		09/91→06/96			
33.332 DF	243 kW		09/87→02/90			
33.332 DFA	243 kW		05/88→02/90			
33.332 DFAK	243 kW		05/88→02/90			
33.332 DFAS	243 kW		05/88→02/90			
33.332 DFK	243 kW		09/87→02/90			
33.332 DFS	243 kW		09/87→02/90			
33.342 DF	250 kW		05/94→06/96			
33.342 DFA	250 kW		05/94→06/96			
33.362 DF	265 kW		09/87→02/90			
33.362 DFA	265 kW		05/88→02/90			
33.362 DFAK	265 kW		05/88→02/90			
33.362 DFAS	265 kW		05/88→02/90			
33.362 DFK	265 kW		09/87→02/90			
33.362 DFS	265 kW		09/87→02/90			
33.372 DF	272 kW		09/91→06/96			
33.372 DFA	272 kW		09/91→06/96			
33.372 DFAK	272 kW		01/91→06/96			
33.372 DFK	272 kW		01/91→06/96			
33.372 DFS	272 kW		09/91→06/96			
33.402 DF	294 kW		05/94→06/96			
33.402 DFA	294 kW		05/94→06/96			
33.402 DFAK	294 kW		05/94→06/96			
33.402 DFK	294 kW		05/94→06/96			
33.402 DFS	294 kW		05/94→06/96			
33.422 DF	309 kW		09/91→06/96			
33.422 DFA	309 kW		09/91→06/96			
33.422 DFAK	309 kW		01/94→06/96			
33.422 DFK	309 kW		01/94→06/96			
33.422 DFS	309 kW		01/94→06/96			
33.462 DF	338 kW		07/89→02/90			
33.462 DFA	338 kW		07/89→02/90			
33.502 DF	368 kW		09/91→06/96			
33.502 DFA	368 kW		09/91→06/96			
35.262 VF	191 kW		02/89→02/90			
35.262 VFA	191 kW		07/89→02/90			
35.262 VFK	191 kW		02/89→02/90			
35.272 VF	198 kW		02/90→12/91			
35.272 VFK	198 kW		02/90→12/92			
35.292 VF	213 kW		10/88→04/95			
35.292 VFK	213 kW		10/88→04/95			
35.302 VF	220 kW		05/90→09/91			
35.302 VFA	220 kW		05/90→09/91			
35.302 VFAK	220 kW		05/90→09/91			
35.302 VFK	220 kW		05/90→09/91			
35.322 VFAK	235 kW		02/90→06/96			
35.322 VFK	235 kW		02/90→06/96			
35.322 VK	235 kW		02/90→06/96			
35.332 VF	243 kW		10/88→04/95			
35.332 VFK	243 kW		10/88→04/95			
35.342 VF	250 kW		05/94→06/96			
35.342 VFK	250 kW		05/94→06/96			
35.362 VF	265 kW		10/88→02/90			
35.362 VFK	265 kW		10/88→02/90			
35.372 VF	249 kW		02/90→04/95			
35.372 VFK	272 kW		02/90→06/96			
35.372 VF	272 kW		02/90→12/97			
35.372 VFK	249 kW		02/90→04/95			
35.372 VFK	272 kW		02/90→06/96			
35.372 VFK	272 kW		02/90→12/97			
35.402 VF	294 kW		05/94→06/96			
35.402 VFK	294 kW		05/94→12/97			

Manufacturer - Model	Power	Displ.	Year of Constr.	Remark	Part Number	Page
MAN - F 90						07/86→
35.402 VFK	294 kW		05/94→06/96	Inner Diameter [mm]: 78; with lock / with key	8XY 004 734-001 Cap, fuel tank	223
35.402 VFK	294 kW		05/94→12/97			
35.422 VF	309 kW		02/90→06/96	Inner Diameter [mm]: 78; without lock; without support strap / with breather valve	8XY 007 023-001 Cap, fuel tank	223
35.422 VFK	309 kW		02/90→12/97			
35.422 VFK	309 kW		02/90→06/96			
35.422 VFK	309 kW		02/90→12/97			
40.372 DF	272 kW		12/91→06/96			
40.372 DFA	272 kW		12/91→06/96			
40.402 DF	294 kW		05/95→06/96			
40.402 DFA	294 kW		05/95→06/96			
40.422 DF	309 kW		12/91→06/96			
40.422 DFA	309 kW		12/91→06/96			
40.462 DF	338 kW		07/89→02/90			
40.462 DFA	338 kW		07/89→02/90			
40.502 DFA	368 kW		02/90→06/96			
41.262 VF	191 kW		07/89→02/90			
41.262 VFK	191 kW		07/89→02/90			
41.272 VF	198 kW		02/90→12/91			
41.292 VF	213 kW		10/88→02/90			
41.292 VFK	213 kW		10/88→02/90			
41.322 VF	235 kW		02/90→06/96			
41.332 VF	243 kW		10/88→02/90			
41.332 VFK	243 kW		10/88→02/90			
41.342 VF	250 kW		05/94→06/96			
41.362 VF	265 kW		10/88→02/90			
41.362 VFK	265 kW		10/88→02/90			
41.372 VF	272 kW		02/90→06/96			
41.402 VF	294 kW		05/94→06/96			
41.422 VF	309 kW		02/90→06/96			
48.292 VF	213 kW		07/89→02/90			
48.292 VFA	213 kW		07/89→02/90			
48.292 VFAK	213 kW		07/89→02/90			
48.332 VF	243 kW		07/89→02/90			
48.332 VFA	243 kW		07/89→02/90			
48.332 VFAK	243 kW		07/89→02/90			
48.362 VF	265 kW		07/89→02/90			
48.362 VFA	265 kW		07/89→02/90			
48.362 VFAK	265 kW		07/89→02/90			
48.462 VF	338 kW		07/89→02/90			
19.362 FS,19.362 FLS,19.362 FLLS	265 kW		07/86→02/90	→06/88; Inner Diameter [mm]: 78; with lock / with key	8XY 004 734-001 Cap, fuel tank	223
				Inner Diameter [mm]: 78; without lock; without support strap / with breather valve	8XY 007 023-001 Cap, fuel tank	223
MAN - F 2000						01/94→
18.273 F, FL, FLL	198 kW		06/94→	Inner Diameter [mm]: 78; with lock / with key	8XY 004 734-001 Cap, fuel tank	223
19.233 FCNG	170 kW					
19.233 FKNG	170 kW			Inner Diameter [mm]: 78; without lock; without support strap / with breather valve	8XY 007 023-001 Cap, fuel tank	223
19.273 F, FL, FLL	198 kW		01/94→			
19.273 FA	198 kW		01/94→			
19.273 FAK	198 kW		01/94→			
19.273 FK	198 kW		01/94→			
19.273 FS,19.273 FLS	198 kW		01/94→12/95			
19.293 FAC	213 kW		01/94→			
19.293 FAK	213 kW		01/94→			
19.293 FAS	213 kW		01/94→			
19.293 FC,19.293 FLC,19.293 FLLC	213 kW		01/94→			
19.293 FK,19.293 FLK	213 kW		01/94→			
19.293 FS,19.293 FLS,19.293 FLLS	213 kW		01/94→			
19.314 FAC	228 kW		05/01→			
19.314 FAK, FA-KI	228 kW		05/01→			
19.314 FAS	228 kW		06/98→			
19.314 FC, FLC, FLLC, FLLW, FRC, FLRC, FLLRC, FLL, FLLR, F-N	228 kW		06/98→			
19.314 FK, FLK, F-KI, FL-KI	228 kW		06/98→			
19.314 FS, FLS, FLLS, FRS, FLRS, FLLRS	228 kW		06/98→			
19.323 FAC	235 kW		01/94→12/95			
19.323 FAK	235 kW		01/94→12/95			
19.323 FAS	235 kW		01/94→12/95			
19.323 FC,19.323 FLC,19.323 FLLC	235 kW		01/94→12/95			
19.323 FK,19.323 FLK	235 kW		01/94→12/95			
19.323 FS,19.323 FLS,19.323 FLLS	235 kW		01/94→12/95			
19.343 FAC	250 kW		01/94→			
19.343 FAK	250 kW		01/94→			

Manufacturer - Model	Power	Displ.	Year of Constr.	Remark	Part Number	Page
MAN - F 2000						01/94→
19.343 FAS	250 kW		01/94→	Inner Diameter [mm]: 78; with lock / with key	8XY 004 734-001 Cap, fuel tank	223
19.343 FC, 19.343 FLC, 19.343 FLLC	250 kW		01/94→			
19.343 FK, 19.343 FLK	250 kW		01/94→	Inner Diameter [mm]: 78; without lock; without support strap / with breather valve	8XY 007 023-001 Cap, fuel tank	223
19.343 FS, 19.343 FLS, 19.343 FLLS	250 kW		01/94→			
19.364 FAC	265 kW		06/98→			
19.364 FAK, FA-KI	265 kW		06/98→			
19.364 FAS	265 kW		06/98→			
19.364 FC, FLC, FLLC, FLLW, FRC, FLRC, FLLRC, FLL, FLLR, F-N	265 kW		06/98→			
19.364 FK, FLK, F-KI, FL-KI	265 kW		06/98→			
19.364 FS, FLS, FLLS, FRS, FLRS, FLLRS	265 kW		06/98→			
19.373 FAC	272 kW		01/94→			
19.373 FAK, FA-KI	272 kW		01/94→			
19.373 FAS	272 kW		01/94→			
19.373 FC, FLC, FLLC, FRC, FLRC, F-NL	272 kW		01/94→			
19.373 FK, FLK, F-KI, FL-KI	272 kW		01/94→			
19.373 FS, FLS, FLLS, FRS, FLRS, FLLRS	272 kW		01/94→			
19.403 FAC	294 kW		01/94→			
19.403 FAK, FA-KI	294 kW		01/94→			
19.403 FAS	294 kW		01/94→			
19.403 FC, FLC, FLLC, FRC, FLRC, F-NL	294 kW		01/94→			
19.403 FK, FLK, F-KI, FL-KI	294 kW		01/94→			
19.403 FS, FLS, FLLS, FRS, FLRS, FLLRS	294 kW		01/94→			
19.414 FAC	301 kW		06/98→			
19.414 FAK, FA-KI	301 kW		06/98→			
19.414 FAS	301 kW		06/98→			
19.414 FC, FLC, FLLC, FRC, FLRC, FLLRC, FLL, FLLR, F-NL	301 kW		06/98→			
19.414 FK, FLK, F-KI, FL-KI	301 kW		06/98→			
19.414 FS, FLS, FLLS, FRS, FLRS, FLLRS	301 kW		06/98→			
19.423 FAC	309 kW		01/94→12/95			
19.423 FAK, FA-KI	309 kW		01/94→			
19.423 FAS	309 kW		01/94→12/95			
19.423 FC, FLC, FLLC, F-NL	309 kW		01/94→			
19.423 FK, FLK, F-KI, FL-KI	309 kW		01/94→			
19.423 FS, FLS, FLLS	309 kW		01/94→			
19.463 FAC	338 kW		01/94→			
19.463 FAK, FA-KI	338 kW		01/94→			
19.463 FAS	338 kW		01/94→			
19.463 FC, FLC, FLLC, FRC, FLRC, F-NL	338 kW		01/94→			
19.463 FK, FLK, F-KI, FL-KI	338 kW		01/94→			
19.463 FS, FLS, FLLS, FRS, FLRS, FLLRS	338 kW		01/94→			
19.464 FAC	338 kW		06/98→			
19.464 FAK, FA-KI	338 kW		06/98→			
19.464 FAS	338 kW		06/98→			
19.464 FC, FLC, FLLC, FLL, FRC, FLLR, FLLRC, FLLW, F-NL	338 kW		06/98→			
19.464 FK, FLK, F-KI, FL-KI	338 kW		06/98→			
19.464 FS, FLS, FLLS, FRS, FLRS, FLLRS	338 kW		06/98→			
19.603 FLS, 19604 FLS	441 kW		04/96→			
23.293 FNLLC	213 kW		01/94→			
23.314 FNLLC	228 kW		05/01→			
23.343 FNLLC	250 kW		01/94→			
23.364 FNLLC	265 kW		05/01→			
23.403 FNLLC	294 kW		01/94→			
23.414 FNLLC	301 kW		05/01→			
23.463 FNLLC	338 kW		01/94→			
23.464 FNLLC	338 kW		05/01→			
24.273 FNLLC	198 kW		01/94→12/95			
24.293 FNLLC	213 kW		01/94→			
24.314 FNLLRC	228 kW		05/01→			
24.323 FNLLC	235 kW		01/94→12/95			
24.343 FNLLC	250 kW		01/94→			
24.364 FNLLRC	265 kW		05/01→			
24.373 FNLLC	272 kW		01/94→12/95			
24.403 FNLLC	294 kW		01/94→			
24.414 FNLLRC	301 kW		05/01→			
24.423 FNLLC	309 kW		01/94→12/95			
24.463 FNLLC	338 kW		01/94→			

Manufacturer - Model	Power	Displ.	Year of Constr.	Remark	Part Number	Page
MAN - F 2000						01/94→
24.464 FNLLRC	338 kW		05/01→	Inner Diameter [mm]: 78; with lock / with key	8XY 004 734-001 Cap, fuel tank	223
26.233 FVL CNG	170 kW		09/96→			
26.233 FVL-KO	170 kW		03/00→	Inner Diameter [mm]: 78; without lock; without support strap / with breather valve	8XY 007 023-001 Cap, fuel tank	223
26.273 DFC,26.273 DFCL	198 kW		01/94→12/95			
26.273 DFK,26.273 DFLK	198 kW		01/94→12/95			
26.273 DFS,26.273 DFSL	198 kW		01/94→12/95			
26.273 FNLC,26.273 FNLLC, 26.273 FVLC	198 kW		01/94→12/95			
26.273 FNLS,26.273 FVLS	198 kW		01/94→12/95			
26.293 DFC,26.293 DFCL	213 kW		01/94→			
26.293 DFK,26.293 DFLK	213 kW		01/94→			
26.293 DFS,26.293 DFSL	213 kW		01/94→			
26.293 FNLC,26.293 FNLLC, 26.293 FVLC	213 kW		01/94→			
26.293 FNLS,26.293 FVLS	213 kW		01/94→			
26.314 DFC, DFCL	228 kW		05/01→			
26.314 DFK, DFLK	228 kW		05/01→			
26.314 DFS, DFSL	228 kW		05/01→			
26.314 DF-TM	228 kW		05/01→			
26.314 FNLC, FNLLC, FNLLRC, FNLLW, FVLC	228 kW		05/01→			
26.314 FNLS	228 kW		05/01→			
26.314 FVL-KO	228 kW		05/01→			
26.314 FVLS, FVLS	228 kW		05/01→			
26.323 DFC,26.323 DFCL	235 kW		01/94→12/95			
26.323 DFK,26.323 DFLK	235 kW		01/94→12/95			
26.323 DFS,26.323 DFSL	235 kW		01/94→12/95			
26.323 FNLC,26.323 FNLLC, 26.323 FVLC	235 kW		01/94→12/95			
26.323 FNLS,26.323 FVLS	235 kW		01/94→12/95			
26.343 DFC,26.343 DFCL	250 kW		01/94→			
26.343 DFK,26.343 DFLK	250 kW		01/94→			
26.343 DFS,26.343 DFSL	250 kW		01/94→			
26.343 FNLC,26.343 FNLLC, 26.343 FVLC	250 kW		01/94→			
26.343 FNLS,26.343 FVLS	250 kW		01/94→			
26.364 DFC, DFCL	265 kW		05/01→			
26.364 DFK, DFLK	265 kW		05/01→			
26.364 DFS, DFSL	265 kW		05/01→			
26.364 DF-TM	265 kW		05/01→			
26.364 FNLC, FNLLC, FNLLRC, FNLLW, FVLC	265 kW		05/01→			
26.364 FNLS	265 kW		05/01→			
26.364 FVL-KO	265 kW		05/01→			
26.364 FVLS, FVLS	265 kW		05/01→			
26.373 DFC,26.373 DFCL	272 kW		01/94→12/95			
26.373 DFK,26.373 DFLK	272 kW		01/94→12/95			
26.373 DFS,26.373 DFSL	272 kW		01/94→12/95			
26.373 FNLC,26.373 FNLLC, 26.373 FVLC	272 kW		01/94→12/95			
26.373 FNLS,26.373 FVLS	272 kW		01/94→12/95			
26.403 DFC,26.403 DFCL	294 kW		01/94→			
26.403 DFK,26.403 DFLK	294 kW		01/94→			
26.403 DFS,26.403 DFSL	294 kW		01/94→			
26.403 FNLC,26.403 FNLLC, 26.403 FVLC	294 kW		01/94→			
26.403 FNLS,26.403 FVLS	294 kW		01/94→			
26.414 DFC, DFCL	301 kW		05/01→			
26.414 DFK, DFLK	301 kW		05/01→			
26.414 DFS, DFSL	301 kW		05/01→			
26.414 DF-TM	301 kW		05/01→			
26.414 FNLC, FNLLC, FNLLRC, FNLLW, FVLC	301 kW		05/01→			
26.414 FNLS	301 kW		05/01→			
26.414 FVL-KO	301 kW		05/01→			
26.414 FVLS, FVLS	301 kW		05/01→			
26.423 DFC,26.423 DFCL	309 kW		01/94→12/95			
26.423 DFK,26.423 DFLK	309 kW		01/94→12/95			
26.423 DFS,26.423 DFSL	309 kW		01/94→12/95			
26.423 FNLC,26.423 FNLLC, 26.423 FVLC	309 kW		01/94→12/95			
26.423 FNLS,26.423 FVLS	309 kW		01/94→12/95			
26.463 DFC, DFCL	338 kW		01/94→			
26.463 DFK,26.463 DFLK	338 kW		01/94→			
26.463 DFS,26.463 DFSL	338 kW		01/94→			
26.463 FNLC, FNLLC, FVLC	338 kW		01/94→			
26.463 FNLS,26.463 FVLS	338 kW		01/94→			
26.464 DFC, DFCL	338 kW		05/01→			
26.464 DFK, DFLK	338 kW		05/01→			
26.464 DFS, DFSL	338 kW		05/01→			
26.464 DF-TM	338 kW		05/01→			

Manufacturer - Model	Power	Displ.	Year of Constr.	Remark	Part Number	Page
MAN - F 2000						01/94→
26.464 FNLC, FNLLC, FNLLW, FVLC	338 kW		05/01→	Inner Diameter [mm]: 78; with lock / with key	8XY 004 734-001 Cap, fuel tank	223
26.464 FNLS	338 kW		05/01→	Inner Diameter [mm]: 78; without lock; without support strap / with breather valve	8XY 007 023-001 Cap, fuel tank	223
26.464 FVL-KO	338 kW		05/01→			
26.464 FVLS, FVLRS	338 kW		05/01→			
26.603 DFC, DFCL	441 kW		06/96→			
26.603 DFK, DFLK	441 kW		06/96→			
26.603 DFS, DFSL	441 kW		06/96→			
26.604 DFSL	441 kW		04/00→			
27.273 DFAC	198 kW		01/94→12/95			
27.273 DFAK	198 kW		01/94→12/95			
27.273 DFAS	198 kW		01/94→12/95			
27.273 DFC	198 kW		01/94→12/95			
27.273 DFK	198 kW		01/94→12/95			
27.273 DFS	198 kW		01/94→12/95			
27.293 DFAC	213 kW		01/94→			
27.293 DFAK	213 kW		01/94→			
27.293 DFAS	213 kW		01/94→			
27.293 DFC	213 kW		01/94→			
27.293 DFK	213 kW		01/94→			
27.293 DFS	213 kW		01/94→			
27.314 DFAC	228 kW		05/01→			
27.314 DFAK, DFA-KI	228 kW		05/01→			
27.314 DFAS	228 kW		05/01→			
27.314 DFC	228 kW		05/01→			
27.314 DFK, DF-KI	228 kW		05/01→			
27.314 DFS	228 kW		05/01→			
27.314 DF-TM	228 kW		05/01→			
27.314 FVL	228 kW		06/98→			
27.323 DFAC	235 kW		01/94→12/95			
27.323 DFAK, DFA-KI	235 kW		01/94→			
27.323 DFAS	235 kW		01/94→12/95			
27.323 DFC	235 kW		01/94→12/95			
27.323 DFK, DF-KI	235 kW		01/94→			
27.323 DFS	235 kW		01/94→12/95			
27.343 DFAC	250 kW		01/94→			
27.343 DFAK	250 kW		01/94→			
27.343 DFAS	250 kW		01/94→			
27.343 DFC	250 kW		01/94→			
27.343 DFK	250 kW		01/94→			
27.343 DFS	250 kW		01/94→			
27.364 DFAC	265 kW		05/01→			
27.364 DFAK, DFA-KI	265 kW		05/01→			
27.364 DFAS	265 kW		05/01→			
27.364 DFC	265 kW		05/01→			
27.364 DFK, DF-KI	265 kW		05/01→			
27.364 DFS	265 kW		05/01→			
27.364 DF-TM	265 kW		05/01→			
27.364 FVL	265 kW		06/98→			
27.373 DFAC	272 kW		01/94→			
27.373 DFAK, DFA-KI	272 kW		01/94→			
27.373 DFAS	272 kW		01/94→			
27.373 DFC	272 kW		01/94→			
27.373 DFK, DF-KI	272 kW		01/94→			
27.373 DFS	272 kW		01/94→			
27.373 DF-TM	272 kW		07/00→			
27.403 DFAC	294 kW		01/94→			
27.403 DFAK, DFA-KI	294 kW		01/94→			
27.403 DFAS	294 kW		01/94→			
27.403 DFC	294 kW		01/94→			
27.403 DFK, DF-KI	294 kW		01/94→			
27.403 DFS	294 kW		01/94→			
27.403 DF-TM	294 kW		07/00→			
27.414 DFAC	301 kW		05/01→			
27.414 DFAK, DFA-KI	301 kW		05/01→			
27.414 DFAS	301 kW		05/01→			
27.414 DFC	301 kW		05/01→			
27.414 DFK, DF-KI	301 kW		05/01→			
27.414 DFS	301 kW		05/01→			
27.414 DF-TM	301 kW		05/01→			
27.414 FVL	301 kW		06/98→			
27.423 DFAC	309 kW		01/94→			
27.423 DFAK, DFA-KI	309 kW		01/94→			
27.423 DFAS	309 kW		01/94→12/95			
27.423 DFC	309 kW		01/94→			
27.423 DFK, DF-KI	309 kW		01/94→			
27.423 DFS	309 kW		01/94→			
27.423 DF-TM	309 kW		07/00→			
27.463 DFAC	338 kW		01/94→			
27.463 DFAK, DFA-KI	338 kW		01/94→			
27.463 DFAS	338 kW		01/94→			

Manufacturer - Model	Power	Displ.	Year of Constr.	Remark	Part Number	Page
MAN - F 2000						01/94→
27.463 DFC	338 kW		01/94→	Inner Diameter [mm]: 78; with lock / with key	8XY 004 734-001 Cap, fuel tank	223
27.463 DFK, DF-KI	338 kW		01/94→			
27.463 DFS	338 kW		01/94→	Inner Diameter [mm]: 78; without lock; without support strap / with breather valve	8XY 007 023-001 Cap, fuel tank	223
27.463 DF-TM	338 kW		07/00→			
27.464 DFAC	338 kW		05/01→			
27.464 DFAK, DFA-KI	338 kW		05/01→			
27.464 DFAS	338 kW		05/01→			
27.464 DFC	338 kW		01/94→			
27.464 DFK, DF-KI	338 kW		05/01→			
27.464 DFS	338 kW		01/94→			
27.464 DF-TM	338 kW		05/01→			
27.464 FVL	338 kW		06/98→			
27.603 DFAS	441 kW		01/96→			
27.603 DFS	441 kW		01/96→			
32.293 VFC	213 kW		08/95→			
32.314 VF, VFC	228 kW		05/01→			
32.314 VFK, VF-HK	228 kW		05/01→			
32.314 VF-TM	228 kW		05/01→			
32.343 VFC	250 kW		08/95→			
32.343 VFK	250 kW		08/95→			
32.364 VF, VFC	265 kW		05/01→			
32.364 VFK, VF-HK	265 kW		05/01→			
32.364 VF-TM	265 kW		05/01→			
32.403 VFC	294 kW		08/95→			
32.403 VFK	294 kW		08/95→			
32.414 VF, VFC	301 kW		05/01→			
32.414 VFK, VF-HK	301 kW		05/01→			
32.414 VF-TM	301 kW		05/01→			
32.463 VFC	338 kW		08/95→			
32.463 VFK	338 kW		08/95→			
32.464 VF, VFC	338 kW		05/01→			
32.464 VFK, VF-HK	338 kW		05/01→			
32.464 VF-TM	338 kW		05/01→			
33.323 DFAC	235 kW		01/94→12/95			
33.323 DFAK	235 kW		01/94→12/95			
33.323 DFAS	235 kW		01/94→12/95			
33.323 DFC	235 kW		01/94→12/95			
33.323 DFK	235 kW		01/94→12/95			
33.323 DFS	235 kW		01/94→12/95			
33.343 DFAC	250 kW		01/94→			
33.343 DFAK	250 kW		01/94→			
33.343 DFAS	250 kW		01/94→			
33.343 DFC	250 kW		01/94→			
33.343 DFK	250 kW		01/94→			
33.343 DFS	250 kW		01/94→			
33.364 DFAC	265 kW		05/01→			
33.364 DFAK, DFA-KI	265 kW		05/01→			
33.364 DFAS	265 kW		05/01→			
33.364 DFC	265 kW		05/01→			
33.364 DFK, DF-KI	265 kW		05/01→			
33.364 DFS, DFRS	265 kW		05/01→			
33.373 DFAC	272 kW		01/94→			
33.373 DFAK, DFA-KI	272 kW		01/94→			
33.373 DFAS	272 kW		01/94→			
33.373 DFC	272 kW		01/94→			
33.373 DFK, DF-KI	272 kW		01/94→			
33.373 DFS, DFRS	272 kW		01/94→			
33.403 DFAC	294 kW		01/94→			
33.403 DFAK, DFA-KI	294 kW		01/94→			
33.403 DFAS	294 kW		01/94→			
33.403 DFC	294 kW		01/94→			
33.403 DFK, DF-KI	294 kW		01/94→			
33.403 DFS, DFRS	294 kW		01/94→			
33.414 DFAC	301 kW		05/01→			
33.414 DFAK, DFA-KI	301 kW		05/01→			
33.414 DFAS	301 kW		05/01→			
33.414 DFC	301 kW		05/01→			
33.414 DFK, DF-KI	301 kW		05/01→			
33.414 DFS, DFRS	301 kW		05/01→			
33.423 DFAC	309 kW		01/94→			
33.423 DFAK, DFA-KI	309 kW		01/94→			
33.423 DFAS	309 kW		01/94→			
33.423 DFC	309 kW		01/94→			
33.423 DFK, DF-KI	309 kW		01/94→			
33.423 DFS, DFRS	309 kW		01/94→			
33.463 DFAC	338 kW		01/94→			
33.463 DFAK, DFA-KI	338 kW		01/94→			
33.463 DFAS	338 kW		01/94→			
33.463 DFC	338 kW		01/94→			
33.463 DFK, DF-KI	338 kW		01/94→			
33.463 DFS, DFRS	338 kW		01/94→			

Manufacturer - Model	Power	Displ.	Year of Constr.	Remark	Part Number	Page
MAN - F 2000						01/94→
33.464 DFAC	338 kW		05/01→	Inner Diameter [mm]: 78; with lock / with key	8XY 004 734-001 Cap, fuel tank	223
33.464 DFAK, DFA-KI	338 kW		05/01→			
33.464 DFAS	338 kW		05/01→	Inner Diameter [mm]: 78; without lock; without support strap / with breather valve	8XY 007 023-001 Cap, fuel tank	223
33.464 DFC	338 kW		05/01→			
33.464 DFK, DF-KI	338 kW		05/01→			
33.464 DFS, DFRS	338 kW		05/01→			
33.603 DFAC	441 kW		06/96→			
33.603 DFAS	441 kW		06/96→			
33.603 DFC	441 kW		06/96→			
33.603 DFS	441 kW		06/96→			
35.314 VF-TM	228 kW		03/02→			
35.343 VFC	250 kW		08/95→			
35.343 VFK	250 kW		08/95→			
35.364 VF, VFC, VFRC	265 kW		05/01→			
35.364 VFK, VF-HK, VF-KI	265 kW		03/02→			
35.364 VF-TM	265 kW		03/02→			
35.373 VF, VFC, VFRC	272 kW		05/01→			
35.373 VFK, VF-HK, VF-KI	272 kW		03/02→			
35.403 VF, VFC, VFRC	294 kW		08/95→			
35.403 VFK, VF-HK, VF-KI	294 kW		03/02→			
35.414 VF, VFC, VFRC	301 kW		05/01→			
35.414 VFK, VF-HK, VF-KI	301 kW		03/02→			
35.414 VF-TM	301 kW		03/02→			
35.423 VF, VFC	309 kW		05/01→			
35.423 VFK, VF-HK, VF-KI	309 kW		03/02→			
35.463 VF, VFC, VFRC	338 kW		08/95→			
35.463 VFK, VF-HK, VF-KI	338 kW		08/95→			
35.464 VF, VFC, VFRC	338 kW		05/01→			
35.464 VFK, VF-HK, VF-KI	338 kW		03/02→			
35.464 VF-TM	338 kW		03/02→			
37.414 VFA	301 kW		06/98→			
37.464 VFA	338 kW		06/98→			
40.273 DFAK	198 kW		01/94→			
40.273 DFK	198 kW		01/94→			
40.373 DFAK	272 kW		05/01→			
40.373 DFK	272 kW		05/01→			
40.403 DFAK	294 kW		01/94→			
40.403 DFAS	294 kW		01/94→			
40.403 DFK	294 kW		01/94→			
40.403 DFS	294 kW		01/94→			
40.414 DFAK	301 kW		05/01→			
40.414 DFK	301 kW		05/01→			
40.423 DFAK	309 kW		05/01→			
40.423 DFK	309 kW		05/01→			
40.463 DFAK	338 kW		01/94→			
40.463 DFAS	338 kW		01/94→			
40.463 DFK	338 kW		01/94→			
40.463 DFS	338 kW		01/94→			
41.343 VFC	250 kW		08/95→			
41.343 VFK	250 kW		08/95→			
41.364 VF, VFC, VFRC	265 kW		05/01→			
41.364 VFK, VF-HK, VF-KI	265 kW		03/02→			
41.373 VF, VFC, VFRC	272 kW		05/01→			
41.373 VFK, VF-HK, VF-KI	272 kW		03/02→			
41.403 VF, VFC, VFRC	294 kW		08/95→			
41.403 VFK, VF-HK, VF-KI	294 kW		08/95→			
41.414 VF, VFC, VFRC	301 kW		05/01→			
41.414 VFK, VF-HK, VF-KI	301 kW		03/02→			
41.423 VF, VFC, VFRC	309 kW		05/01→			
41.423 VFK, VF-HK, VF-KI	309 kW		03/02→			
41.463 VF, VFC, VFRC	338 kW		08/95→			
41.463 VFK, VF-HK, VF-KI	338 kW		08/95→			
41.464 VF, VFC, VFRC	338 kW		06/98→			
41.464 VFK, VF-HK, VF-KI	338 kW		03/02→			
MAN - G 90						09/87→05/95
10.150 F, 10.150 FL	92 kW		05/90→10/93	Inner Diameter [mm]: 78; with lock / with key	8XY 004 734-001 Cap, fuel tank	223
10.150 F, 10.150 FL	110 - 114 kW		09/87→10/93			
10.150 FK	110 - 114 kW		09/87→10/93	Inner Diameter [mm]: 78; without lock; without support strap / with breather valve	8XY 007 023-001 Cap, fuel tank	223
6.100 F	75 kW		09/87→10/93			
6.100 FK	75 kW		09/87→10/93			
8.100 F	75 kW		09/87→10/93			
8.100 FK	75 kW		09/87→10/93			
8.150 F, 8.150 FL	92 kW		05/90→10/93			
8.150 F, 8.150 FL	110 - 114 kW		09/87→10/93			
8.150 FAE	110 - 114 kW		05/88→05/95			
8.150 FAKO	110 kW		10/92→05/95			
8.150 FK	110 - 114 kW		09/87→10/93			
8.150 FOC	110 - 114 kW		07/88→10/93			
8.150 FS, 8.150 FLS	110 - 114 kW		09/87→10/93			
8.170 FOC	125 - 131 kW		02/89→10/93			

Manufacturer - Model	Power	Displ.	Year of Constr.	Remark	Part Number	Page			
MAN - G 90						09/87→05/95			
9.150 F,9.150 FL	92 kW		05/90→10/93	Inner Diameter [mm]: 78; with lock / with key	8XY 004 734-001 Cap,	223			
9.150 F,9.150 FL	110 - 114 kW		09/87→10/93						
9.150 FAE	110 - 114 kW		05/88→05/92	Inner Diameter [mm]: 78; without lock; without support strap / with breather valve	8XY 007 023-001 Cap,	223			
9.150 FAKO	110 kW		10/92→05/95						
9.150 FK	110 - 114 kW		09/87→10/93						
9.150 FOC	110 - 114 kW		07/88→10/93						
9.150 FS,9.150 FLS	110 - 114 kW		09/87→10/93						
9.170 FOC	125 - 131 kW		02/89→10/93						
MAN - G									10/79→08/88
10.136 F,10.136 FL	100 kW		09/81→09/87	Inner Diameter [mm]: 78; with lock / with key	8XY 004 734-001 Cap,	223			
10.136 FK	100 kW		09/81→09/87						
6.90 F	66 - 66 kW		10/79→09/87	Inner Diameter [mm]: 78; without lock; without support strap / with breather valve	8XY 007 023-001 Cap,	223			
6.90 FK	66 kW		10/79→09/87						
8.136 F,8.136 FL	100 kW		10/79→09/87						
8.136 FAE	100 kW		12/83→08/88						
8.136 FK	100 kW		10/79→08/88						
8.136 FOC	100 kW		03/82→07/88						
8.90 F	66 kW		10/79→09/87						
8.90 FK	66 kW		10/79→09/87						
9.136 F,9.136 FL	100 kW		10/79→09/87						
9.136 FAE	100 kW		12/83→08/88						
9.136 FK	100 kW		10/79→08/88						
9.136 FOC	100 kW		03/82→07/88						
MAN - L 2000									10/93→
10.145 LC,10.145 LLC, LRC, LLRC (LE140C)	103 kW		09/00→				Inner Diameter [mm]: 78; with lock / with key	8XY 004 734-001 Cap,	223
10.145 LK, LRK, L-KI, LR-KI (LE140C)	103 kW		09/00→						
10.145 LLS, LLRS (LE140C)	103 kW		09/00→	Inner Diameter [mm]: 78; without lock; without support strap / with breather valve	8XY 007 023-001 Cap,	223			
10.150 FOC	114 - 118 kW		02/95→01/96						
10.153 F	114 kW		10/93→						
10.153 FA	114 kW		10/93→						
10.153 LAEK	114 kW		10/93→06/96						
10.153 LC,10.153 LLC	114 kW		10/93→06/96						
10.153 LK	114 kW		10/93→06/96						
10.153 LLS	114 kW		10/93→06/96						
10.155 LK, LRK	114 kW		02/04→						
10.163 F	114 kW		05/94→						
10.163 FA	114 kW		05/94→						
10.163 LAC, LAEC, LARC, LAERC	114 - 118 kW		05/94→						
10.163 LAK, LAEK, LARK, LAERK	114 - 118 kW		01/95→						
10.163 LC,10.163 LLC	114 - 118 kW		05/94→						
10.163 LC,10.163 LLC, LRC, LLRC (LE160C)	114 kW		09/00→						
10.163 LK, LRK, L-KI, LR-KI	114 - 118 kW		05/94→						
10.163 LLS, LLRS	114 - 118 kW		05/94→						
10.185 LAC, LAEC, LARC, LAERC, LA-LA, LAE-LF (LE180C)	132 kW		09/00→						
10.185 LAK, LAEK, LARK, LAERK (LE180C)	132 kW		09/00→						
10.185 LC,10.185 LLC, LRC, LLRC (LE180C)	132 kW		09/00→						
10.185 LK, LRK, L-KI, LR-KI (LE180C)	132 kW		09/00→						
10.185 LLS, LLRS (LE180C)	132 kW		09/00→						
10.220 FOC,10.220 FOCL	162 kW		02/95→						
10.223 F, 10.223 FL	162 kW		10/93→06/96						
10.223 FA	162 kW		10/93→06/96						
10.223 LAEC	162 kW		01/95→06/96						
10.223 LC,10.223 LLC	162 - 169 kW		10/93→06/96						
10.223 LK	162 - 169 kW		10/93→06/96						
10.223 LLS	162 - 169 kW		10/93→06/96						
10.224 F, 10.224 FL	162 kW		05/94→						
10.224 FA	162 kW		05/94→						
10.224 LAC, LAEC, LARC, LAERC	162 kW		01/95→						
10.224 LAK, LAEK, LARK, LAERK	162 kW		01/95→						
10.224 LC,10.224 LLC, LRC, LLRC	162 kW		05/94→						
10.224 LK, LRK, L-KI, LR-KI	162 kW		05/94→						
10.224 LLS, LLRS	162 kW		05/94→						
10.225 LAC, LAEC, LARC, LAERC, LA-LF, LAE-LF (LE220C)	162 kW		09/00→						

Manufacturer - Model	Power	Displ.	Year of Constr.	Remark	Part Number	Page
MAN - L 2000						10/93→
10.225 LAK, LAEK, LARK, LAERK (LE220C)	162 kW		09/00→	Inner Diameter [mm]: 78; with lock / with key	8XY 004 734-001 Cap, fuel tank	223
10.225 LC, 10.225 LLC, LRC, LLRC	162 kW		09/00→	Inner Diameter [mm]: 78; without lock; without support strap / with breather valve	8XY 007 023-001 Cap, fuel tank	223
10.225 LC, 10.225 LLC, LRC, LLRC (LE220C)	162 kW		09/00→			
10.225 LK, LRK , L-KI, LR-KI(LE220C)	162 kW		09/00→			
10.225 LLS, LLRS (LE220C)	162 kW		09/00→			
8.103 LC, 8.103 LLC	75 kW		10/93→06/96			
8.103 LK	75 kW		10/93→06/96			
8.113 LC, 8.113 LLC	81 kW		08/95→			
8.113 LC,8.113 LLC, LRC, LLRC, (LE110C)	83 kW		09/00→			
8.113 LK, LRK, L-KI, LR-KI	81 kW		08/95→			
8.145, LA-LF LAE-LF	103 kW		07/00→			
8.145 LC,8.145 LLC, L-LF (LE140C)	103 kW		09/00→			
8.145 LLS, LLRS (LE140C)	103 kW		09/00→			
8.145 LRK, L-KI, LR-KILK (LE140C)	103 kW		09/00→			
8.150 FOC,8.150 FOCL	114 - 118 kW		02/95→			
8.153 LAEC	114 kW		01/95→06/96			
8.153 LAEK	114 kW		01/95→09/96			
8.153 LC,8.153 LLC	114 kW		10/93→07/97			
8.153 LK	114 kW		10/93→07/97			
8.153 LLS	114 kW		10/93→06/96			
8.155 L, LR, LC, LLC, LRC, LLRC, L-LF	114 kW		02/04→			
8.155 LK, LRK	114 kW		02/04→			
8.155 LLS, LLRS	114 kW		02/04→			
8.163 LAC, LAEC, LARC, LAERC, LA-LF, LAE-LF	114 - 118 kW		01/95→			
8.163 LAEC	104 kW		08/95→03/97			
8.163 LAK, LARK, LAEK, LAERK	104 kW		04/00→			
8.163 LC,8.163 LLC	114 - 118 kW		05/94→			
8.163 LC,8.163 LLC, LRC, LLRC, L-LF	104 kW		08/95→			
8.163 LC, 8.163 LLC (LE160C)	114 kW		09/00→			
8.163 LK, LRK, L-KI, LR-KI	114 - 118 kW		05/94→			
8.163 LLS, LLRS	114 - 118 kW		05/94→			
8.185 LAC, LAEC, LARC, LAERC, LA-LF, LAE-LF (LE180C)	132 kW		09/00→			
8.185 LAK, LAEK, LARK, LAERK (LE180C)	132 kW		09/00→			
8.185 LC,8.185 LLC, LRC, LLRC, L-LF (LE180C)	132 kW		09/00→			
8.185 LK, LRK, L-KI, LR-KI (LE180C)	132 kW		09/00→			
8.185 LLS, LLRS (LE180C)	132 kW		09/00→			
8.220 FOC,8.220 FOCL	162 kW		04/95→			
8.223 LAEC	162 kW		01/95→06/96			
8.223 LC,8.223 LLC	162 - 169 kW		10/93→06/96			
8.223 LK	162 - 169 kW		10/93→06/96			
8.223 LLS	162 - 169 kW		10/93→06/96			
8.224 LAC, LAEC, LARC, LAERC	162 kW		01/95→			
8.224 LAK, LAEK, LARK, LAERK	162 kW		01/95→			
8.224 LC,8.224 LLC, LRC, LLRC	162 kW		05/94→			
8.224 LK, LRK, L-KI, LR-KI	162 kW		05/94→			
8.224 LLS, LLRS	162 kW		05/94→			
8.225 LAC, LAEC, LARC, LAERC (LE220C)	162 kW		09/00→			
8.225 LAK, LAEK, LARK, LAERK (LE220C)	162 kW		09/00→			
8.225 LC,8.225 LLC, LRC, LLRC (LE220C)	162 kW		09/00→			
8.225 LK, LRK, L-KI, LR-KI (LE220C)	162 kW		09/00→			
8.225 LLS, LLRS (LE220C)	162 kW		09/00→			
9.145 LC,9.145 LLC, LRC, LLRC (LE140C)	103 kW		09/00→			
9.145 LK, LRK, L-KI, LR-KI (LE140C)	103 kW		09/00→			
9.145 LLS, LLRS (LE140C)	103 kW		09/00→			
9.153 LC,9.153 LLC	114 kW		10/93→06/96			
9.153 LK	114 kW		10/93→06/96			
9.153 LLS	114 kW		10/93→12/95			
9.155 L, LC, LLC, LRC, LLRC	114 kW		02/04→			
9.155 LK, LRK	114 kW		02/04→			
9.155 LLS, LLRS	114 kW		02/04→			

Manufacturer - Model	Power	Displ.	Year of Constr.	Remark	Part Number	Page
MAN - L 2000						10/93→
9.163 LC	104 kW		08/95→03/97	Inner Diameter [mm]: 78; with lock / with key	8XY 004 734-001 Cap, fuel tank	223
9.163 LC,9.163 LLC, LRC, LLRC	114 - 118 kW		05/94→			
9.163 LK	104 kW		08/95→03/97	Inner Diameter [mm]: 78; without lock; without support strap / with breather valve	8XY 007 023-001 Cap, fuel tank	223
9.163 LK, LRK, L-KI, LR-KI	114 - 118 kW		05/94→			
9.163 LLS, LLRS	114 - 118 kW		05/94→			
9.185 LC,9.185 LLC, LRC, LLRC (LE180C)	132 kW		09/00→			
9.185 LK, LRK, L-KI, LR-KI (LE180C)	132 kW		09/00→			
9.185 LLS, LLRS (LE 180C)	132 kW		09/00→			
9.223 LC,9.223 LLC	162 - 169 kW		10/93→06/96			
9.223 LK	162 - 169 kW		10/93→06/96			
9.223 LLS	162 - 169 kW		10/93→06/96			
9.224 LC,9.224 LLC, LRC, LLRC	162 kW		05/94→			
9.224 LK, LRK, L-KI, LR-KI	162 kW		05/94→			
9.224 LLS, LLRS	162 kW		05/94→			
9.225 LC,9.225 LLC, LRC, LLRC (LE220C)	162 kW		09/00→			
9.225 LK, LRK, L-KI, LR-KI (LE220C)	162 kW		09/00→			
9.225 LLS, LLRS (LE220C)	162 kW		09/00→			
MAN - M 90						08/88→06/96
12.152 F,12.152 FL	110 - 114 kW		12/88→05/94	Inner Diameter [mm]: 78; with lock / with key	8XY 004 734-001 Cap, fuel tank	223
12.152 FK	110 - 114 kW		12/88→05/94			
12.152 FS,12.152 FLS	110 - 114 kW		12/88→05/94	Inner Diameter [mm]: 78; without lock; without support strap / with breather valve	8XY 007 023-001 Cap, fuel tank	223
12.192 F,12.192 FL	140 kW		07/90→06/96			
12.192 FA	140 kW		10/92→06/96			
12.192 FAK	140 kW		10/92→06/96			
12.192 FK	140 kW		07/90→06/96			
12.192 FS,12.192 FLS	140 kW		07/90→06/96			
12.222 F,12.222 FL	162 kW		05/94→06/96			
12.222 FA	162 kW		05/94→06/96			
12.222 FAK	162 kW		05/94→06/96			
12.222 FK	162 kW		05/94→06/96			
12.222 FLS	162 kW		05/94→06/96			
12.232 F,12.232 FL	169 kW		08/88→06/96			
12.232 FA	169 kW		05/90→06/96			
12.232 FAK	169 kW		05/90→06/96			
12.232 FK	169 kW		08/88→06/96			
12.232 FS,12.232 FLS	169 kW		08/88→06/96			
12.262 F,12.262 FL	191 kW		08/95→06/96			
12.262 FK	191 kW		08/95→06/96			
12.262 FS,12.262 FLS	191 kW		08/95→06/96			
12.272 F,12.272 FL	198 kW		09/91→10/92			
12.272 F,12.272 FL	198 kW		10/92→06/96			
12.272 FA	198 kW		10/93→04/95			
12.272 FAK	198 kW		10/93→04/95			
12.272 FK	198 kW		09/91→10/92			
12.272 FK	198 kW		10/92→06/96			
12.272 FS,12.272 FLS	198 kW		09/91→10/92			
12.272 FS,12.272 FLS	198 kW		10/92→06/96			
14.152 F,14.152 FL	110 - 114 kW		12/88→04/94			
14.152 F,14.152 FL	114 kW		05/94→06/96			
14.152 FK	110 - 114 kW		12/88→05/94			
14.152 FK	114 kW		05/94→06/96			
14.152 FS,14.152 FLS	110 - 114 kW		12/88→05/94			
14.152 FS,14.152 FLS	114 kW		05/94→06/96			
14.162 F,14.162 FL	118 kW		08/95→06/96			
14.162 FK	118 kW		08/95→06/96			
14.162 FS,14.162 FLS	118 kW		08/95→06/96			
14.192 F,14.192 FL	137 kW		08/88→06/90			
14.192 F,14.192 FL	140 kW		07/90→06/96			
14.192 FA	137 kW		08/88→06/90			
14.192 FK	137 kW		08/88→06/90			
14.192 FK	140 kW		07/90→06/96			
14.192 FS,14.192 FLS	137 kW		08/88→06/90			
14.192 FS,14.192 FLS	140 kW		07/90→06/96			
14.222 F,14.222 FL	162 kW		05/94→06/96			
14.222 FK	162 kW		05/94→06/96			
14.222 FLS	162 kW		05/94→06/96			
14.232 F,14.232 FL	160 kW		05/90→04/95			
14.232 F,14.232 FL	169 kW		08/88→06/96			
14.232 FK	169 kW		08/88→06/96			
14.232 FS,14.232 FLS	160 kW		05/90→04/95			
14.232 FS,14.232 FLS	169 kW		08/88→06/96			
14.262 F,14.262 FL	191 kW		08/95→06/96			
14.262 FK	191 kW		08/95→06/96			
14.262 FS,14.262 FLS	191 kW		08/95→06/96			
14.272 F,14.272 FL	198 kW		09/91→10/92			
14.272 F,14.272 FL	198 kW		10/92→06/96			

Manufacturer - Model	Power	Displ.	Year of Constr.	Remark	Part Number	Page
MAN - M 90					08/88→06/96	
14.272 FK	198 kW		09/91→10/92	Inner Diameter [mm]: 78; with lock / with key	8XY 004 734-001 Cap, fuel tank	223
14.272 FK	198 kW		10/92→06/96			
14.272 FS,14.272 FLS	198 kW		09/91→10/92	Inner Diameter [mm]: 78; without lock; without support strap / with breather valve	8XY 007 023-001 Cap, fuel tank	223
14.272 FS,14.272 FLS	198 kW		12/92→06/96			
17.192 F,17.192 FL	137 kW		08/88→06/90			
17.192 F,17.192 FL	140 kW		07/90→04/95			
17.192 FA	137 kW		02/89→06/90			
17.192 FA	140 kW		07/90→06/96			
17.192 FAK	137 kW		02/89→06/90			
17.192 FAK	140 kW		07/90→06/96			
17.192 FK	137 kW		08/88→06/90			
17.192 FK	140 kW		07/90→01/91			
17.192 FS,17.192 FLS	137 kW		08/88→06/90			
17.192 FS,17.192 FLS	140 kW		07/90→04/95			
17.222 FA	162 kW		05/94→06/96			
17.222 FAK	162 kW		05/94→06/96			
17.232 F,17.232 FL	160 kW		05/90→04/95			
17.232 F,17.232 FL	169 kW		08/88→04/95			
17.232 FA	160 kW		05/90→04/95			
17.232 FA	169 kW		02/89→06/96			
17.232 FAK	160 kW		05/90→04/95			
17.232 FAK	169 kW		02/89→06/96			
17.232 FK	160 kW		05/90→01/91			
17.232 FK	169 kW		08/88→01/91			
17.232 FS,17.232 FLS	160 kW		05/90→04/95			
17.232 FS,17.232 FLS	169 kW		08/88→04/95			
17.272 FLS	198 kW		09/91→05/95			
17.272 FLS	198 kW		10/92→05/95			
18.192 F,18.192 FL,18.192 FLL	140 kW		09/90→06/96			
18.192 FK	140 kW		09/90→06/96			
18.222 F,18.222 FL,18.222 FLL	162 kW		05/94→06/96			
18.222 FK	162 kW		05/94→06/96			
18.232 F,18.232 FL,18.232 FLL	169 kW		09/90→06/96			
18.232 FK	169 kW		09/90→06/96			
18.262 F,18.262 FL,18.262 FLL	191 kW		08/95→06/96			
18.262 FK	191 kW		08/95→06/96			
18.272 F,18.272 FL,18.272 FLL	198 kW		09/91→05/94			
18.272 F,18.272 FL,18.272 FLL	198 kW		10/92→06/96			
18.272 FK	198 kW		09/91→05/94			
18.272 FK	198 kW		10/92→06/96			
24.192 FNL,24.192 FNLL,24.192 FVL	140 kW		07/89→06/96			
24.222 FNL,24.222 FNLL,24.222 FVL	162 kW		05/94→06/96			
24.232 FNL	160 kW		05/90→04/95			
24.232 FNL,24.232 FNLL,24.232 FVL	169 kW		07/89→06/96			
24.262 FNL,24.262 FNLL,24.262 FVL	191 kW		08/95→06/96			
24.272 FNL,24.272 FNLL,24.272 FVL	198 kW		10/92→06/96			
24.272 FNL,24.272 FVL	198 kW		09/91→05/94			
MAN - M 2000 L					08/95→	
12.163 LC, LLC, LRC, LLRC	114 kW		08/95→	Inner Diameter [mm]: 78; with lock / with key	8XY 004 734-001 Cap, fuel tank	223
12.163 LK, LRK	114 kW		08/95→			
12.224, 12.225, LK, LRK	162 kW		08/95→	Inner Diameter [mm]: 78; without lock; without support strap / with breather valve	8XY 007 023-001 Cap, fuel tank	223
12.224 LC, LLC, LRC, LLRC	162 kW		08/95→			
14.163 LC, LLC, LRC, LLRC	114 kW		08/95→			
14.163 LK, LRK	114 kW		08/95→			
14.224 LAC, LARC	162 kW		08/95→			
14.224 LAK, LARK	162 kW		08/95→			
14.224 LC, LLC, LLLC, LRC, LLRC, LLLRC	162 kW		08/95→			
14.224 LK, LRK	162 kW		08/95→			
14.263, 14.264 LAC, LARC	191 kW		08/95→			
14.263, 14.264 LAK, LARK	191 kW		08/95→			
14.263, 14.264 LC, LLC, LLLC, LRC, LLRC, LLLRC	191 kW		08/95→			
14.263, 14.264 LK, LRK	191 kW		08/95→			
14.284, 14.285, LAC, LARC	206 kW		06/98→			
14.284, 14.285, LAK, LARK	206 kW		06/98→			
14.284, 14.285, LA-LF	206 kW		06/98→			
14.284, 14.285, LK, LRK	206 kW		10/98→			
14.284 LC, LLC, LLLC, LRC, LLRC, LLLRC	206 kW		10/98→			
15.163 LC, LLC, LRC	114 kW		08/95→			
15.163 LK, LRK	114 kW		08/95→			
15.224 LC, LLC, LLLC, LRC, LLRC, LLLRC	162 kW		08/95→			
15.224 LK, LRK	162 kW		08/95→			

Manufacturer - Model	Power	Displ.	Year of Constr.	Remark	Part Number	Page
MAN - M 2000 L						08/95→
15.263, 15.264 LC, LLC, LLLC, LRC, LLRC, LLLRC	191 kW		08/95→	Inner Diameter [mm]: 78; with lock / with key Inner Diameter [mm]: 78; without lock; without support strap / with breather valve	8XY 004 734-001 Cap, fuel tank	223
15.263, 15.264 LK, LRK	191 kW		08/95→		8XY 007 023-001 Cap, fuel tank	223
15.284 LC, LLC, LLLC, LRC, LLRC, LLLRC	206 kW		06/98→			
15.284 LK, LRK	206 kW		06/98→			
18.224, 18.225, LAC, LARC	162 kW		08/95→			
18.224, 18.225, LAK, LARK	162 kW		08/95→			
18.224, 18.225, LC, LLC, LLLC, LRC, LLRC, LLLRC	162 kW		08/95→			
18.224, 18.225, LK, LLK, LRK, LLRK	162 kW		08/95→			
18.263, 18.264, LAC, LARC	191 kW		08/95→			
18.263, 18.264, LAK, LARK	191 kW		08/95→			
18.263, 18.264, LC, LLC, LLLC, LRC, LLRC, LLLRC	191 kW		08/95→			
18.263, 18.264, LK, LLK, LRK, LLRK	191 kW		08/95→			
18.284, 18.285, LK, LLK, LRK, LLRK	206 kW		06/98→			
18.284, 18.285, L-KO, LR-KO	206 kW		06/98→			
18.284 LAC, LARC	206 kW		06/98→			
18.284 LAK, LARK	206 kW		06/98→			
18.284 LC, LLC, LLLC, LRC, LLRC, LLLRC	206 kW		06/98→			
MAN - M 2000 M						08/95→
12.224 MC, MLC	162 kW		02/03→	Inner Diameter [mm]: 78; with lock / with key Inner Diameter [mm]: 78; without lock; without support strap / with breather valve	8XY 004 734-001 Cap, fuel tank	223
12.224 MLS	162 kW		02/03→		8XY 007 023-001 Cap, fuel tank	223
12.255 MC, MLC	180 kW		02/03→			
12.255 MLS	180 kW		02/03→			
12.264 MC, MLC	191 kW		02/03→			
12.264 MLS	191 kW		02/03→			
12.284 MC, MLC	206 kW		02/00→			
12.284 MLS	206 kW		02/00→			
14.224 MAK	162 kW		08/95→12/05			
14.224 MA-KO, MA-LF	162 kW		11/02→			
14.224 MC, MLC, MLLC	162 kW		08/95→12/05			
14.224 MK	162 kW		08/95→12/05			
14.224 MLS, MLRS	162 kW		08/95→12/05			
14.225 MC, MLC, MLLC	162 kW		10/00→			
14.225 MLS, MLRS	162 kW		02/03→			
14.255 MAK	180 kW		11/02→			
14.255 MA-KO, MA-LF	180 kW		11/02→			
14.255 MC, MLC, MLLC	180 kW		10/00→			
14.255 MLS, MLRS	180 kW		10/00→			
14.264 MAK	191 kW		11/02→			
14.264 MA-KO, MA-LF	191 kW		11/02→			
14.264 MC, MLC, MLLC	191 kW		08/95→12/05			
14.264 MLS, MLRS	191 kW		08/95→12/05			
14.284 MAK	206 kW		06/98→12/05			
14.284 MA-KO, MA-LF	206 kW		06/98→12/05			
14.284 MC, MLC, MLLC	206 kW		06/98→12/05			
14.284 MLS, MLRS	206 kW		06/98→12/05			
14.285 MLS, MLRS	206 kW		02/03→			
18.224 MAC, MARC	162 kW		08/95→12/05			
18.224 MAK, MARK	162 kW		08/95→12/05			
18.224 MC, MLC, MLLC, MRC, MLRC, MLLRC	162 kW		08/95→12/05			
18.224 MK, 18.224 MLK, MRK, MLRK	162 kW		08/95→12/05			
18.224 M-KO, MR-KO	162 kW		02/00→			
18.224 MLS, MLRS	162 kW		08/95→12/05			
18.225 MAC, MARC	162 kW		02/03→			
18.225 MC, MLC, MLLC, MRC, MLRC, MLLRC	162 kW		10/00→			
18.255 MAC, MARC	180 kW		10/00→			
18.255 MAK, MARK	180 kW		10/00→			
18.255 MC, MLC, MLLC, MLRC, MLLRC	180 kW		10/00→			
18.255 MK, MLK, MRK, MLRK	180 kW		11/02→			
18.255 M-KO, MR-KO	180 kW		10/00→			
18.255 MLS, MLRS	180 kW		10/00→			
18.264 MAC, MARC	191 kW		08/95→12/05			
18.264 MAK, MARK	191 kW		08/95→12/05			
18.264 MC, MLC, MLLC, MRC, MLRC, MLLRC	191 kW		08/95→12/05			
18.264 MK, 18.264 MLK, MRK, MLRK	191 kW		08/95→12/05			
18.264 M-KO, MR-KO	191 kW		02/00→			
18.264 MLS, MLRS	191 kW		08/95→12/05			

Manufacturer - Model	Power	Displ.	Year of Constr.	Remark	Part Number	Page
MAN - M 2000 M						08/95→
18.284 MAC, MARC	206 kW		06/98→12/05	Inner Diameter [mm]: 78; with lock / with key	8XY 004 734-001 Cap, fuel tank	223
18.284 MAK, MARK	206 kW		06/98→12/05			
18.284 MC, MLC, MLLC, MRC, MLRC, LLRC	206 kW		06/98→12/05	Inner Diameter [mm]: 78; without lock; without support strap / with breather valve	8XY 007 023-001 Cap, fuel tank	223
18.284 MK, 18.284 MLK, MRK, MLRK	206 kW		06/98→12/05			
18.284 M-KO, MR-KO	206 kW		02/00→			
18.284 MLS, MLRS	206 kW		06/98→12/05			
18.285 MAC, MARC	206 kW		02/03→			
18.285 MC, MLC, MLLC	206 kW		06/98→12/05			
18.285 MLS, MLRS	206 kW		02/03→			
25.224 MNLC, MNLLC, MNLRC, MNLLRC, MVLC	162 kW		08/95→12/05			
25.225 MNLC, MNLLC, MNLRC, MNLLRC, MVLC	162 kW		02/03→			
25.255 MNLC, MNLLC, MNLRC, MNLLRC, MVLC	180 kW		10/00→			
25.264 MNLC, MNLLC, MNLRC, MNLLRC, MVLC	191 kW		08/95→12/05			
25.284 MNLC, MNLLC, MNLRC, MNLLRC, MVLC	206 kW		02/00→			
25.285 MNLC, MNLLC, MNLRC, MNLLRC, MVLC	206 kW		02/03→			
MAN - TGA						04/00→
18.310, 18.320 FAC, FHLC	228 - 235 kW		05/04→	Inner Diameter [mm]: 78; with lock / with key	8XY 004 734-001 Cap, fuel tank	223
18.310, 18.320 FAK, FAK-L, FALK, FALK-L, FHLK, FHLK/M	228 - 235 kW		05/04→			
18.310, 18.320 FAS, FALS, FHLS, FHLS/M	228 - 235 kW		05/04→	Inner Diameter [mm]: 78; without lock; without support strap / with breather valve	8XY 007 023-001 Cap, fuel tank	223
18.310, 18.320 FC, FLC, FLLC, FLLC/N, FLLW, FLLW/N	228 - 235 kW		05/04→			
18.310, 18.320 FK, FK-L, FLK, FLK/M	228 - 235 kW		05/04→			
18.310, 18.320 FLS, FLRS, FLLS, FLLRS	228 - 235 kW		05/04→			
18.310, 18320 FC, FLC, FRC, FLLC, FLLC/N, FLLW, FLLRC, FLLRW	228 - 235 kW		04/00→			
18.310, 18320 FK, FLK, FK-L, FLRK	228 - 235 kW		12/00→			
18.310 FAC, FARC	228 kW		09/02→			
18.310 FAK, FAK-L, FALK	228 kW		09/02→			
18.310 FAS, FARS	228 kW		09/02→			
18.310 FLS, FLLS, FLLS/N, FLS-TS, FLRS, FLLRS	228 kW		04/00→			
18.350, 18.360 FAC, FHLC	257 - 265 kW		05/04→			
18.350, 18.360 FAK, FAK-L, FALK, FALK-L, FHLK, FHLK/M	257 - 265 kW		05/04→			
18.350, 18.360 FAS, FALS, FHLS, FHLS/M	257 - 265 kW		05/04→			
18.350, 18.360 FC, FLC, FLLC, FLLRC, FLLC/N, FLLW, FLLW/N	257 - 265 kW		05/04→			
18.350, 18.360 FK, FK-L, FLK, FLK/M,	257 - 265 kW		05/04→			
18.350 FLS, FLS/N, FLS/M, FLS-TS, FLLS, FLLS/N, FLLRS	257 kW		05/04→			
18.360 FAC, FARC	265 kW		09/02→			
18.360 FAK, FALK, FAK-L, FALK-L	265 kW		09/02→			
18.360 FAS, FALS, FARS	265 kW		09/02→			
18.360 FC, FLC, FRC, FLLC, FLLC/N, FLLW, FLLRW	265 kW		04/00→			
18.360 FK, FLK, FK-L, FLRK	265 kW		12/00→			
18.360 FLS, FLLS, FLLS/N, FLS-TS, FLRS, FLLRS	265 kW		04/00→			
18.360 FLS, FLLS, FLRS, FLLRS	265 kW		01/06→			
18.390, 18.400 FAC, FHLC	287 - 294 kW		05/04→			
18.390, 18.400 FAK, FAK-L, FALK, FALK-L, FHLK, FHLK/M	287 - 294 kW		05/04→			
18.390, 18.400 FAS, FALS, FHLS, FHLS/M	287 - 294 kW		05/04→			
18.390, 18.400 FC, FLC, FLLC, FLLC/N, FLLW, FLLW/N	287 - 294 kW		05/04→			
18.390, 18.400 FK, FK-L, FLK, FLK/M	287 - 294 kW		05/04→			
18.390 FLS, FLS-TS, FLS/M, FLLS, FLLS/N, FLLS/M, FLLRS	287 kW		05/04→			
18.400 FLS, FLLS, FLRS, FLLRS	294 kW		10/05→			
18.410, 18420 FAK, FAK-L, FALK	301 - 309 kW		09/02→			

Manufacturer - Model	Power	Displ.	Year of Constr.	Remark	Part Number	Page
MAN - TGA						04/00→
18.410, 18420 FC, FRC, FLC, FLRC, FLLC, FLLC/N, FLLW, FLLRC	301 - 309 kW		04/00→	Inner Diameter [mm]: 78; with lock / with key	8XY 004 734-001 Cap, fuel tank	223
18.410, 18420 FK, FK-L, FLK, FLRK	301 - 309 kW		12/00→	Inner Diameter [mm]: 78; without lock; without support strap / with breather valve	8XY 007 023-001 Cap, fuel tank	223
18.410 FAC, FARC	301 kW		09/02→			
18.410 FAS, FALS, FARS	301 kW		09/02→			
18.410 FLS, FLLS, FLLS/N, FLS-TS, FLRS, FLLRS	301 kW		04/00→			
18.430, 18.440 FAC, FHLC	316 - 324 kW		05/04→			
18.430, 18.440 FAK, FALK, FALK-L, FHLK, FHLK/M	316 - 324 kW		05/04→			
18.430, 18.440 FAS, FALS, FHLS, FHLS/M	316 - 324 kW		05/04→			
18.430, 18.440 FC, FLC, FLLC, FLLW, FLLW/N, FLLRC, FLLRW	316 - 324 kW		05/04→			
18.430, 18.440 FK, FK-L, FLK, FLK/M	316 - 324 kW		05/04→			
18.430 FLS, FLS/M, FLS-TS, FLLS, FLLS/N, FLLRS, FLRS	316 kW		05/04→			
18.440 FLS, FLLS, FLRS, FLLRS	324 kW		09/05→			
18.460 FAK	338 kW		12/00→			
18.460 FC, FLC, FRC, FLLC, FLLC/N, FLLW, FLLRC, FLLRW	338 kW		04/00→			
18.460 FK, FK-L, FLK, FLRK	338 kW		12/00→			
18.460 FLS, FLLS, FLLS/N, FLS-TS, FLRS, FLLRS	338 kW		04/00→			
18.480 FAC	353 kW		02/06→			
18.480 FAC, FARC	353 kW		09/02→			
18.480 FAK, FAK-L, FALK	353 kW		09/02→			
18.480 FAK, FALK	353 kW		02/06→			
18.480 FAS, FALS	353 kW		02/06→			
18.480 FAS, FALS, FARS	353 kW		09/02→			
18.480 FC, FLC, FLLC, FLLRC, FLLW, FLRC	353 kW		01/06→			
18.480 FC, FLC, FLLC, FLLW, FLLRW, FLLRC	353 kW		09/02→			
18.480 FHLC	353 kW		04/06→			
18.480 FHLK, FHLK/M	353 kW		04/06→			
18.480 FHLS, FHLS/M	353 kW		04/06→			
18.480 FK, FK-L, FLK	353 kW		01/06→			
18.480 FK, FLK, FK-L	353 kW		09/02→			
18.480 FLS, FLLS, FLLS/N, FLS-TS, FLRS-WW	353 kW		09/02→			
18.480 FLS, FLLS, FLRS, FLLRS	353 kW		01/06→			
18.510 FC, FLC, FRC, FLLC, FLLC/N, FLLW, FLLRC, FLLRW	375 kW		09/00→			
18.510 FLS, FLLS, FLLS/N, FLRS, FLLRS	375 kW		04/00→			
18.530 FAC	390 kW		04/04→			
18.530 FAK, FALK	390 kW		04/04→			
18.530 FAS, FALS	390 kW		04/04→			
18.530 FC, FLC, FLLC, FLLC/N, FLLW, FLLRC, FLLRW	390 kW		09/02→			
18.530 FLS, FLLS, FLLS/N	390 kW		09/02→			
18.540 FLC, FLRC, FLLC, FLLRC, FLLW	397 kW		08/06→			
18.540 FLS, FLRS, FLLS, FLLRS	397 kW		08/06→			
19.350 FS, FRS, FLS, FLRS-WW	257 kW		05/04→			
19.360 FS, FRS, FLS, FLRS-WW	265 kW		05/04→			
19.360 FS/M-WW, FRS/M-WW	265 kW		05/04→			
19.390 FS, FRS, FLS, FLRS-WW	287 kW		05/04→			
19.400 FS/M-WW, FRS/M-WW, FLS, FLRS	294 kW		05/04→			
19.410 FS/M-WW, FRS/M-WW	301 kW		05/04→			
19.430 FS/M-WW, FLS, FRS, FLRS	316 kW		05/04→			
19.440 FRS, FS/M-WW, FLS, FLRS	324 kW		02/06→			
19.460 FS/M-WW, FRS/M-WW	338 kW		05/04→			
19.480 FLS, FRS, FLRS-WW	353 kW		02/06→			
19.480 FS/M, FRS/M-WW	353 kW		02/06→			
19.480 FS/M-WW, FRS/M-WW	353 kW		05/04→			
24.350, 24.360 FNLLC, FNLLW/N, FNLLRW	257 - 265 kW		05/04→			
24.350, 24.360 FPLS, FPLRS	257 - 265 kW		02/04→			
24.360 FNLLC/N, FNLLW, FNLLRW, FNLLRC	265 kW		09/01→			
24.390, 24.400 FNLLC/N, FNLLW/N, FNLLRC, FNLLRW	287 - 294 kW		05/04→			
24.390, 24.400 FPLS, FPLRS	287 - 294 kW		05/04→			

Manufacturer - Model	Power	Displ.	Year of Constr.	Remark	Part Number	Page
MAN - TGA						04/00→
24.410 FNLLC/N, FNLLW, FNLLRW	301 kW		09/01→	Inner Diameter [mm]: 78; with lock / with key	8XY 004 734-001 Cap, fuel tank	223
24.430, 24.440 FNLLC/N, FNLR, FNLLW	316 - 324 kW		05/04→	Inner Diameter [mm]: 78; without lock; without support strap / with breather valve	8XY 007 023-001 Cap, fuel tank	223
24.430, 24.440 FPLS, FPLRS	316 - 324 kW		05/04→			
24.460 FNLLC/N, FNLLW, FNLLRC, FNLLRW	338 kW		09/01→			
24.480 FNLLC/N, FNLLW, FNLLRC, FNLLRW	353 kW		09/02→			
24.480 FNLLC/N, FNLLW/N	353 kW		01/06→			
24.480 FPLS, FPLRS	353 kW		07/05→			
24.480 FPLS, FPLRS	353 kW		01/06→			
24.510 FNLLC/N, FNLLW, FNLLRW	375 kW		09/01→			
24.530 FNLLC/N, FNLLW, FNLLRW	390 kW		09/01→			
24.530 FPLS, FPLRS	390 kW		07/05→			
24.540 FNLLC/N, FLLCW/N	397 kW		01/06→			
26.280 FNLC, FNLLC, FNLLW	206 kW		11/02→			
26.310, 26.320 FDC, FDRC, FDC/M, FDRC/M, FDLC, FNHLC, FVHLC	228 - 235 kW		05/04→			
26.310, 26.320 FDH, FDHC, FDHC/M	228 - 235 kW		06/05→			
26.310, 26.320 FDHK	228 - 235 kW		06/05→			
26.310, 26.320 FDHS, FDHS/M	228 - 235 kW		06/05→			
26.310, 26.320 FDH-TM	228 - 235 kW		06/05→			
26.310, 26.320 FDK, FDLK	228 - 235 kW		05/04→			
26.310, 26.320 FDS, FDS/M, FDL, FDRS, FDRS/M, FNHLS, FDLRS	228 - 235 kW		05/04→			
26.310, 26.320 FD-TM	228 - 235 kW		06/05→			
26.310, 26.320 FNLC, FNLLC, FNLR, FNLLRC, FNLLW	228 - 235 kW		05/04→			
26.310, 26.320 FNLS, FNLLS, FNLR, FNLLRS	228 - 235 kW		05/04→			
26.310, 26.320 FVHL-KO	228 - 235 kW		06/05→			
26.310, 26.320 FVLC	228 - 235 kW		02/04→			
26.310, 26.320 FVL-KO	228 - 235 kW		02/04→			
26.310 FDAC	228 kW		01/04→			
26.310 FDAC, FDARC	228 kW		02/02→			
26.310 FDAK	228 kW		02/02→			
26.310 FDAK	228 kW		01/04→			
26.310 FDAS	228 kW		01/04→			
26.310 FDAS, FDARS	228 kW		02/02→			
26.310 FDC, FDLC, FDRC, FDLC/M, FDLRC	228 kW		01/01→			
26.310 FDK, FDLK, FDRK	228 kW		09/02→			
26.310 FDS, FDL, FDL/M, FDLRS	228 kW		01/01→			
26.310 FD-TM, FDR-TM	228 kW		10/00→			
26.310 FNLC, FNLLC, FVLC, FNLLW, FNLR, FNLLRW	228 kW		09/00→			
26.310 FPLS, FVLS, FNLS, FNLLS, FPLRS, FNLR, FVLR	228 kW		12/00→			
26.310 FVLC	228 kW		09/03→			
26.310 FVL-KO	228 kW		12/00→			
26.320 FDAC	235 kW		04/06→			
26.320 FDAK	235 kW		04/06→			
26.320 FDAS	235 kW		04/06→			
26.330 FNLC, FNLLC, FNLLW	240 kW		11/02→			
26.350, 26.360 FDC, FDRC, FDC/M, FDRC/M, FDLC, FDLRC, FNHLC	257 - 265 kW		05/04→			
26.350, 26.360 FDHK, FDHLK	257 - 265 kW		05/04→			
26.350, 26.360 FDHS, FDHS/M, FDHLS	257 - 265 kW		05/04→			
26.350, 26.360 FDH-TM	257 - 265 kW		05/04→			
26.350, 26.360 FDK, FDLK, FDRK	257 - 265 kW		05/04→			
26.350, 26.360 FDS, FDS/M, FDL, FDRS, FNHLS, FPHLS	257 - 265 kW		05/04→			
26.350, 26.360 FD-TM	257 - 265 kW		02/04→			
26.350, 26.360 FNLC, FNLLC, FNLLW, FNLR, FNLLRC	257 - 265 kW		05/04→			
26.350, 26.360 FNLS, FNLLS, FNLR, FNLLRS, FPLS, FPLRS	257 - 265 kW		05/04→			
26.350, 26.360 FVHL-KO	257 - 265 kW		06/05→			
26.350, 26.360 FVL-KO	257 - 265 kW		01/04→			
26.350 FDAC	257 kW		02/04→			
26.350 FDAK	257 kW		02/04→			

Manufacturer - Model	Power	Displ.	Year of Constr.	Remark	Part Number	Page
MAN - TGA						04/00→
26.350 FDAS	257 kW		02/04→	Inner Diameter [mm]: 78; with lock / with key	8XY 004 734-001 Cap, fuel tank	223
26.350 FDHC, FDHC/M	257 kW		04/05→			
26.350 FDLRC-WW	257 kW		05/04→	Inner Diameter [mm]: 78; without lock; without support strap / with breather valve	8XY 007 023-001 Cap, fuel tank	223
26.350 FDLS, FDLRS, FDLRS/M, FDLRS-WW	257 kW		05/04→			
26.350 FVHLC	257 kW		06/05→			
26.350 FVHLS	257 kW		07/05→			
26.350 FVLC	257 kW		01/04→			
26.350 FVLS, FVLRS	257 kW		07/05→			
26.360 FDAC, FDARC	265 kW		02/02→			
26.360 FDAC, FDARC	265 kW		06/04→			
26.360 FDAK, FDALK	265 kW		02/02→			
26.360 FDAK, FDARK	265 kW		06/04→			
26.360 FDAS, FDARS	265 kW		02/02→			
26.360 FDAS, FDARS	265 kW		06/04→			
26.360 FDC, FDLC, FDLC/M, FDRC, FDLRC-WW	265 kW		01/01→			
26.360 FDHC, FDHLC	265 kW		05/04→			
26.360 FDK, FDLK, FDRK, FDLRK	265 kW		09/02→			
26.360 FDLC-WW, FDLRC	265 kW		05/04→			
26.360 FDLS, FDLRS-WW, FNHLS	265 kW		05/04→			
26.360 FDLS, FDLS/M, FDLRS, FDLRS/M, FDLRS-WW, FDRS	265 kW		09/03→			
26.360 FDS, FDLS, FNLS, FNLLS, FPLS, FPLRS, FVLS, FVLRS	265 kW		12/00→			
26.360 FD-TM, FDR-TM	265 kW		01/01→			
26.360 FNLC, FNLLC, FNLLW, FNLLRC, FNLLRW, FVLC	265 kW		09/00→			
26.360 FVHLC	265 kW		04/06→			
26.360 FVHLS	265 kW		04/06→			
26.360 FVLC	265 kW		04/06→			
26.360 FVL-KO	265 kW		12/00→			
26.360 FVLS, FVLRS	265 kW		04/06→			
26.390, 26.400 FDC, FDRC, FDLRC, FDRC/M, FDLC, FNHLC, FVHLC	287 - 294 kW		05/04→			
26.390, 26.400 FDHC, FDHC/M, FDHLC	287 - 294 kW		06/05→			
26.390, 26.400 FDHK, FDHLK	287 - 294 kW		06/05→			
26.390, 26.400 FDHS, FDHS/M, FDHLS	287 - 294 kW		06/05→			
26.390, 26.400 FDK, FDLK	287 - 294 kW		05/04→			
26.390, 26.400 FDS, FDS/M, FDLS, FDLRS, FNHLS, FPHLS, FVHLS	287 - 294 kW		05/04→			
26.390, 26.400 FD-TM	287 - 294 kW		05/04→			
26.390, 26.400 FNLC, FNLLC, FNLLW, FNLLRC, FNLLRC	287 - 294 kW		05/04→			
26.390, 26.400 FNLS, FNLLS, FNLR, FNLLRS, FPLS, FPLRS	287 - 294 kW		05/04→			
26.390, 26.400 FVHL-KO	287 - 294 kW		06/05→			
26.390, 26.400 FVL-KO	287 - 294 kW		02/04→			
26.390 FDAC, FDALC	287 kW		01/04→			
26.390 FDAK, FDALK	287 kW		02/04→			
26.390 FDAS, FDALS	287 kW		02/04→			
26.390 FDH-TM	287 kW		06/05→			
26.390 FVLC	287 kW		02/04→			
26.390 FVLS, FVLRS	287 kW		07/05→			
26.400 FDAC, FDALC	294 kW		01/04→			
26.400 FDAK, FDALK	294 kW		01/04→			
26.400 FDAS, FDALS	294 kW		01/04→			
26.400 FDH-TM	294 kW		04/06→			
26.400 FVLC	294 kW		04/06→			
26.400 FVLS, FVLRS	294 kW		04/06→			
26.410 FDAC, FDARC	301 kW		02/02→			
26.410 FDAK, FDALK	301 kW		02/02→			
26.410 FDAS, FDALS, FDARS	301 kW		02/02→			
26.410 FDC, FDLC, FDLC/M, FDLC-WW; FDRC-WW, FDLRC-WW	301 kW		01/01→			
26.410 FDK, FDRK, FDLK, FDLRK	301 kW		09/01→			
26.410 FDS, FDLS, FDLS/M, FDLS-WW, FDRS-WW, FDLRS-WW	301 kW		06/01→			
26.410 FD-TM, FDR-TM	301 kW		01/01→			
26.410 FNLC, FNLLC, FNLLW, FNLLRC, FNLLRC, FVLC	301 kW		04/00→			

Manufacturer - Model	Power	Displ.	Year of Constr.	Remark	Part Number	Page
MAN - TGA						04/00→
26.410 FPLS, FPLRS, FVLS, FNLS, FNLLS	301 kW		12/00→	Inner Diameter [mm]: 78; with lock / with key	8XY 004 734-001 Cap, fuel tank	223
26.410 FVLC	301 kW		09/03→	Inner Diameter [mm]: 78; without lock; without support strap / with breather valve	8XY 007 023-001 Cap, fuel tank	223
26.410 FVL-KO	301 kW		12/00→			
26.410 FVLS, FVLRS	301 kW		07/05→			
26.430, 26.440, FNLC, FNLLC, FNLLW, FNLRC, FNLLRC, FVLC	316 - 324 kW		05/04→			
26.430, 26.440, FNLS, FNLLS, FNLRS, FNLLRS, FPLS, FPLRS	316 - 324 kW		05/04→			
26.430, 26.440 FDC, FDRC, FDLC, FDLRC, FDLC/M, FNHLC, FVHLC	316 - 324 kW		05/04→			
26.430, 26.440 FDHC, FDHC/M, FDHLC	316 - 324 kW		06/05→			
26.430, 26.440 FDHK, FDHLK	316 - 324 kW		06/05→			
26.430, 26.440 FDHS, FDHS/M, FDHLS	316 - 324 kW		06/05→			
26.430, 26.440 FDH-TM	316 - 324 kW		06/05→			
26.430, 26.440 FDK, FDLK	316 - 324 kW		05/04→			
26.430, 26.440 FDS, FDLS, FDRS, FDLRS, FNHLS, FPHLS, FVHLS	316 - 324 kW		02/04→			
26.430, 26.440 FD-TM	316 - 324 kW		05/04→			
26.430, 26.440 FVLH-KO	316 - 324 kW		06/05→			
26.430 FDAC, FDALC	316 kW		01/04→			
26.430 FDAK, FDALK	316 kW		01/04→			
26.430 FDAS, FDALS	316 kW		01/04→			
26.430 FDLS, FDLS/M, FDLRS-WW	316 - 324 kW		02/04→			
26.430 FVL-KO	316 kW		12/00→			
26.430 FVLS, FVLRS	316 kW		07/05→			
26.440 FDAC, FDALC	324 kW		09/05→			
26.440 FDAK, FDALK	324 kW		01/04→			
26.440 FDAS, FDALS	324 kW		01/04→			
26.440 FDLC-WW, FDLRC-WW	324 kW		02/06→			
26.440 FDS, FDLS, FDLS-WW, FDLRS-WW	324 kW		02/06→			
26.440 FVL-KO	324 kW		09/05→			
26.440 FVLS, FVLRS	324 kW		09/05→			
26.460 FDC, FDLC, FDLC/M, FDLC-WW, FDRC, FDLRC-WW	338 kW		01/01→			
26.460 FDK, FDLK, FDLRK	338 kW		06/01→			
26.460 FDS, FDLS, FDLS/M, FDLS-WW, FDRS-WW, FDLRS-WW	338 kW		01/01→			
26.460 FNLC, FNLRC, FNLLC, FNLLRW, FNLLRC	338 kW		04/00→			
26.460 FPLS, FPLRS, FVLS, FVLRS, FNLS, FNLLS, FNLRS	338 kW		12/00→			
26.460 FVLC	338 kW		02/01→			
26.460 FVL-KO	338 kW		12/00→			
26.480 FDAC, FDALC	353 kW		02/06→			
26.480 FDAC, FDALC, FDARC	353 kW		09/02→			
26.480 FDAK, FDALK	353 kW		09/02→			
26.480 FDAK, FDALK	353 kW		02/06→			
26.480 FDAS, FDALS	353 kW		02/06→			
26.480 FDAS, FDALS, FDARS	353 kW		09/02→			
26.480 FDC, FDC/M, FDLC, FDLRC, FDRC, FNHLC, FVHLC, FDLRC-WW	353 kW		02/06→			
26.480 FDC, FDLC, FDRC, FDLC/M, FDLRC-WW	353 kW		09/02→			
26.480 FDHC, FDHC/M, FDHLC	353 kW		02/06→			
26.480 FDHK, FDHLK	353 kW		02/06→			
26.480 FDHS, FDHS/M, FDHLS	353 kW		02/06→			
26.480 FDH-TM	353 kW		02/06→			
26.480 FDK, FDLK	353 kW		02/06→			
26.480 FDK, FDLK, FDLRK	353 kW		09/02→			
26.480 FDS, FDLS, FDLRS, FNHLS, FPHLS, FVHLS	353 kW		02/06→			
26.480 FDS, FDLS, FDLS/M, FDLRS-WW, FDRS	353 kW		09/02→			
26.480 FD-TM	353 kW		09/02→			
26.480 FD-TM	353 kW		02/06→			
26.480 FNLC, FNLLC, FVLC, FNLLRC, FVLLW	353 kW		09/02→			
26.480 FNLC, FNLRC-WW, FNLLC, FNLLRC, FNLLW, FVLC	353 kW		02/06→			
26.480 FNLS, FNLLS, FNLRS, FPLS, FVLS	353 kW		09/02→			

Manufacturer - Model	Power	Displ.	Year of Constr.	Remark	Part Number	Page
MAN - TGA						04/00→
26.480 FNLS, FNLLS, FNLRS, FPLS, FVLS, FVLRS	353 kW		02/06→	Inner Diameter [mm]: 78; with lock / with key	8XY 004 734-001 Cap, fuel tank	223
26.480 FVHL-KO	353 kW		02/06→	Inner Diameter [mm]: 78; without lock; without support strap / with breather valve	8XY 007 023-001 Cap, fuel tank	223
26.480 FVL-KO	353 kW		09/02→			
26.480 FVL-KO	353 kW		01/06→			
26.510 FDC, FDC/M, FDRC, FDLC, FDLC/M, FDLRC	375 kW		01/01→			
26.510 FDS, FDLS, FDLS/M, FDRS, FDLRS	375 kW		01/01→			
26.510 FNLC, FNLLC, FNLLW, FNLLRC, FVLC	375 kW		12/00→			
26.510 FNLS, FNLLS, FNLRS, FPLS, FVLS	375 kW		12/00→			
26.530 FDAC, FDALC	390 kW		07/06→			
26.530 FDAK, FDALK	390 kW		09/02→			
26.530 FDAS, FDALS	390 kW		07/06→			
26.530 FDC, FDLC, FDC/M, FDLRC	390 kW		01/01→			
26.530 FDK, FDLK, FDLRK	390 kW		09/02→			
26.530 FDS, FDLS, FDLS/M, FDLRS	390 kW		01/01→			
26.530 FNLC, FNLLC, FNLLW, FNLLRC, FVLC, FVLRC	390 kW		09/02→			
26.530 FNLS, FNLLS, FNLRS, FPLS, FVLS, FVLRS	390 kW		09/02→			
26.540 FNLC, FNLLC, FNLLRC, FNLLW	397 kW		08/06→			
27.440 FDS, FDLS, FDRS, FDLRS	324 kW		10/08→			
28.310, 28.320 FNLC, FNLLC, FNLL-LE, FNLLR-LE	228 - 235 kW		07/06→			
28.310, 28.320 FNLC, FNLLC, FNLLRC, FNLLR-LE	228 - 235 kW		07/06→			
28.310 FNLC, FNLLC	228 kW		09/02→			
28.310 FNLC, FNLLC, FNLRC	228 kW		09/02→			
28.310 FNLS, FNLRS	228 kW		09/02→			
28.310 FNLS, FNLRS	228 kW		06/04→			
28.320 FNLC, FNLLC, FNLRC	235 kW		06/04→			
28.320 FNLS, FNLRS	235 kW		06/04→			
28.350, 28.360 FNLC, FNLLC, FNLL-LE	257 - 265 kW		07/06→			
28.350, 28.360 FNLC, FNLLC, FNLRC, FNLL-LE	257 - 265 kW		06/04→			
28.350 FANLC	257 kW		07/06→			
28.350 FANLK	257 kW		07/06→			
28.350 FNLS, FNLRS-WW	257 kW		02/04→			
28.360 FANLC	265 kW		07/06→			
28.360 FANLK	265 kW		07/06→			
28.360 FNLC, FNLLC	265 kW		09/02→			
28.360 FNLS, FNLRS	265 kW		09/02→			
28.360 FNLS, FNLRS-WW	265 kW		04/06→			
28.390, 28.400 FNLC, FNLLC, FNLRC-WW	287 - 294 kW		06/04→			
28.390 FANLC	287 kW		07/06→			
28.390 FANLK	287 kW		07/06→			
28.390 FNLLC	353 kW		07/06→			
28.390 FNLS, FNLRS	287 kW		05/04→			
28.400 FANLC	294 kW		07/06→			
28.400 FANLK	294 kW		07/06→			
28.400 FNLS, FNLRS	294 kW		04/06→			
28.410 FANLC	301 kW		07/06→			
28.410 FANLK	301 kW		07/06→			
28.410 FNLC, FNLLC	301 kW		09/02→			
28.410 FNLC, FNLLC, FNLRC	301 kW		09/02→			
28.410 FNLS, FNLRS	301 kW		09/02→			
28.430, 28.440 FNLC, FNLLC, FNLRC-WW	316 - 324 kW		06/04→			
28.430 FANLC	316 kW		07/06→			
28.430 FANLK	316 kW		07/06→			
28.430 FNLS, FNLRS-WW	316 kW		05/04→			
28.440 FANLC	324 kW		07/06→			
28.440 FANLK	324 kW		07/06→			
28.440 FNLS, FNLRS-WW	324 kW		09/05→			
28.460 FNLC, FNLLC, FNLRC	338 kW		09/02→			
28.460 FNLS, FNLRS	338 kW		09/02→			
28.480 FANLC	353 kW		07/06→			
28.480 FANLK	353 kW		07/06→			
28.480 FNLC, FNLLC, FNLRC	353 kW		09/02→			
28.480 FNLC, FNLRC-WW, FNLLC	353 kW		02/06→			
28.480 FNLS, FNLRS	353 kW		09/02→			

Manufacturer - Model	Power	Displ.	Year of Constr.	Remark	Part Number	Page
MAN - TGA						04/00→
28.480 FNLS, FNLRS-WW	353 kW		02/06→	Inner Diameter [mm]: 78; with lock / with key	8XY 004 734-001 Cap, fuel tank	223
28.510 FNLC, FNLLC, FNLRC	375 kW		09/02→			
28.510 FNLS, FNLRS	375 kW		09/02→	Inner Diameter [mm]: 78; without lock; without support strap / with breather valve	8XY 007 023-001 Cap, fuel tank	223
28.530 FANLC	390 kW		07/06→			
28.530 FANLK	390 kW		07/06→			
28.530 FNLC, FNLLC, FNLRC	390 kW		09/02→			
28.530 FNLS, FNLRS	390 kW		09/02→			
28.540 FNLC, FNLLC	397 kW		08/06→			
28.540 FNLS	397 kW		08/06→			
32.310 FFDC, FFDLC, FFDLRC	228 kW		01/02→			
32.310 FFDK, FFDLK	228 kW		01/02→			
32.310 FFD-TM	228 kW		01/02→			
32.350, 32.360 FFDRC	257 - 265 kW		05/04→			
32.350, 32.360 FFD-TM, FFDR-TM	257 - 265 kW		02/04→			
32.360 FFDC, FFDLC, FFDLRC	265 kW		01/02→			
32.360 FFDK, FFDLK	265 kW		01/02→			
32.360 FFD-TM	265 kW		01/02→			
32.390, 32.400 FFDRC	287 - 294 kW		05/04→			
32.390, 32.400 FFD-TM, FFDR-TM	287 - 294 kW		05/04→			
32.410 FFDC, FFDLC, FFDR, FFDLRC	301 kW		01/02→			
32.410 FFDK, FFDLK	301 kW		01/02→			
32.410 FFD-TM	301 kW		01/02→			
32.430, 32.440 FFDRC	316 - 324 kW		05/04→			
32.430, 32.440 FFD-TM, FFDR-TM	316 - 324 kW		05/04→			
32.460 FFDC, FFDLC, FFDLRC	338 kW		01/02→			
32.460 FFDK, FFDLK	338 kW		01/02→			
32.460 FFD-TM	338 kW		01/02→			
32.480 FFDC, FFDLC, FFDLRC	353 kW		09/02→			
32.480 FFDK, FFDLK	353 kW		09/02→			
32.480 FFDRC	353 kW		02/06→			
32.480 FFD-TM	353 kW		09/02→			
32.480 FFD-TM, FFDR-TM	353 kW		02/06→			
33.350, 33.360 FDAC, FDHC, FDHC/M	257 - 265 kW		06/05→			
33.350, 33.360 FDAK, FDHK	257 - 265 kW		06/05→			
33.350, 33.360 FDAS, FDHS, FDHS/M	257 - 265 kW		06/05→			
33.350, 33.360 FDC, FDC/M, FDLC, FDRC	257 - 265 kW		05/04→			
33.350, 33.360 FDK, FDLK, FDRK	257 - 265 kW		05/04→			
33.350, 33.360 FDS, FDLS, FDS/M, FDRS	257 - 265 kW		05/04→			
33.350 FDC-TM, FDRC-TM	257 kW		09/07→			
33.360 FDAC, FDARC, FDAC-WW	265 kW		09/02→			
33.360 FDAK, FDAK-WW	265 kW		09/02→			
33.360 FDAS, FDAS-WW	265 kW		09/02→			
33.360 FDC, FDC-WW, FDLC/M, FDRC-WW, FDLRC	265 kW		10/00→			
33.360 FDC-TM, FDRC-TM	265 kW		09/07→			
33.360 FDK, FDK-WW, FDLK, FDRK-WW	265 kW		01/01→			
33.360 FDS, FDS-WW, FDLS, FDLRS, FDRS-WW	265 kW		10/00→			
33.360 FD-TM, FDR-TM	265 kW		01/01→			
33.390, 33.400 FDAC, FDHC, FDHC/M	287 - 295 kW		06/05→			
33.390, 33.400 FDAK, FDHK	287 - 295 kW		06/05→			
33.390, 33.400 FDAS, FDHS, FDHS/M	287 - 295 kW		06/05→			
33.390, 33.400 FDC, FDLC, FDRC, FDC/M	287 - 294 kW		05/04→			
33.390, 33.400 FDC-TM, FDRC-TM	287 - 294 kW		09/07→			
33.390, 33.400 FDK, FDLK, FDRK	287 - 294 kW		05/04→			
33.390, 33.400 FDS, FDLS, FDLRS, FDRS, FDS/M	287 - 294 kW		05/04→			
33.410 FDAC, FDAC-WW, FDALC	301 kW		09/02→			
33.410 FDAK, FDAK-WW, FDALK	301 kW		09/02→			
33.410 FDAS, FDAS-WW, FDALS	301 kW		09/02→			
33.410 FDC, FDC-WW, FDLC, FDLRC, FDRC-WW	301 kW		10/00→			

Manufacturer - Model	Power	Displ.	Year of Constr.	Remark	Part Number	Page
MAN - TGA						04/00→
33.410 FDK, FDK-WW, FDLK, FDRK-WW	301 kW		10/00→	Inner Diameter [mm]: 78; with lock / with key	8XY 004 734-001 Cap, fuel tank	223
33.410 FDS, FDS-WW, FDLS, FDLS/M, FDLRS, FDRS-WW	301 kW		10/00→	Inner Diameter [mm]: 78; without lock; without support strap / with breather valve	8XY 007 023-001 Cap, fuel tank	223
33.410 FD-TM, FDR-TM	301 kW		10/00→			
33.430, 33.440 FDAC, FDALC, FDHC, FDHC/M	316 - 324 kW		06/05→			
33.430, 33.440 FDAK, FDALK, FDHK	316 - 324 kW		06/05→			
33.430, 33.440 FDAS, FDALS, FDHS	316 - 324 kW		06/05→			
33.430, 33.440 FDC, FDLC, FDRC, FDLRC, FDC/M	316 - 324 kW		05/04→			
33.430, 33.440 FDK, FDLK, FDRK	316 - 324 kW		05/04→			
33.430, 33.440 FDS, FDLS, FDRS, FDLRS, FDS/M	316 - 324 kW		05/04→			
33.440 FDAC, FDHC	324 kW		06/05→			
33.440 FDAK, FDHK	324 kW		06/05→			
33.440 FDAS, FDHS	324 kW		06/05→			
33.440 FDC, FDRC	324 kW		06/05→			
33.440 FDC-TM, FDRC-TM	324 kW		09/07→			
33.440 FDK, FDRK	324 kW		06/05→			
33.440 FDS, FDRS	324 kW		06/05→			
33.460 FDAC-WW	338 kW		09/02→			
33.460 FDAK-WW	338 kW		09/02→			
33.460 FDAS-WW	338 kW		09/02→			
33.460 FDC, FDC-WW, FDLC, FDLRC, FDRC-WW	338 kW		09/02→			
33.460 FDK, FDK-WW, FDLK, FDRK-WW	338 kW		09/02→			
33.460 FDS, FDLS, FDLS/M, FDLRS, FDRS-WW	338 kW		09/02→			
33.460 FD-TM, FDR-TM	338 kW		09/02→			
33.480 FDAC, FDAC-WW, FDALC, FDARC	353 kW		09/02→			
33.480 FDAC, FDALC, FDHC, FDHC/M	353 kW		02/06→			
33.480 FDAK, FDAK-WW, FDALK	353 kW		09/02→			
33.480 FDAK, FDALK, FDHK	353 kW		02/06→			
33.480 FDAS, FDALS, FDHS	353 kW		02/06→			
33.480 FDAS, FDAS-WW, FDARS, FDALS	353 kW		09/02→			
33.480 FDC, FDC-WW, FDLC, FDRC-WW, FDLRC	353 kW		09/02→			
33.480 FDC, FDLC, FDRC, FDC/M	353 kW		01/06→			
33.480 FDC-TM, FDRC-TM	353 kW		09/07→			
33.480 FDK, FDK-WW, FDLK, FDRK-WW	353 kW		09/02→			
33.480 FDK, FDLK, FDRK	353 kW		01/06→			
33.480 FDS, FDRS, FDLS, FDS/M	353 kW		01/06→			
33.480 FDS, FDS-WW, FDLS, FDLS/M, FDRS-WW, FDLRS	353 kW		09/02→			
33.480 FD-TM	353 kW		09/02→			
33.510 FDC, FDC/M, FDLC, FDRC, FDLRC	375 kW		09/02→			
33.510 FDS, FDLS/M, FDRS, FDLRS/M	375 kW		09/02→			
33.530 FDAC, FDALC	390 kW		09/02→			
33.530 FDAK, FDALK	390 kW		09/02→			
33.530 FDAS, FDALS	390 kW		09/02→			
33.530 FDC, FDC/M, FDLC, FDRC, FDLRC	390 kW		09/02→			
33.530 FDK, FDLK	390 kW		07/03→			
33.530 FDS, FDLS, FDLS/M, FDRS, FDLRS	390 kW		07/03→			
35.310, 35.320 FFDC, FFDLC	228 - 235 kW		02/04→			
35.310, 35.320 FFDK, FFDLK	228 - 235 kW		02/04→			
35.310, 35.320 FFD-TM	228 - 235 kW		02/04→			
35.310 FFDC, FFDLC	228 kW		06/03→			
35.310 FFDK, FFDLK	228 kW		06/03→			
35.310 FFD-TM	228 kW		11/03→			
35.350, 35.360 FFDC, FFDRC, FFDLC	257 - 265 kW		02/04→			
35.350, 35.360 FFDK, FFDRC, FFDLK	257 - 265 kW		02/04→			
35.350, 35.360 FFD-TM	257 - 265 kW		02/04→			
35.350 FFDHK, FFDHLK	257 kW		07/06→			

Manufacturer - Model	Power	Displ.	Year of Constr.	Remark	Part Number	Page
MAN - TGA						04/00→
35.350 FFDH-TM	257 kW		07/06→	Inner Diameter [mm]: 78; with lock / with key	8XY 004 734-001 Cap, fuel tank	223
35.350 FFNLC	257 kW		07/06→			
35.360 FFDC, FFDLC	265 kW		10/03→	Inner Diameter [mm]: 78; without lock; without support strap / with breather valve	8XY 007 023-001 Cap, fuel tank	223
35.360 FFDHK, FFDHLK	265 kW		07/06→			
35.360 FFDH-TM	265 kW		07/06→			
35.360 FFDK, FFDLK	265 kW		10/03→			
35.360 FFD-TM	265 kW		11/03→			
35.360 FFNHLC	265 kW		07/06→			
35.360 FFNLC	265 kW		07/06→			
35.390, 35.400 FFDC, FFDRC, FFDLC	287 - 294 kW		02/04→			
35.390, 35.400 FFDK, FFDRC, FFDLK	287 - 294 kW		02/04→			
35.390, 35.400 FFD-TM	287 - 294 kW		02/04→			
35.390 FDNLC	287 kW		07/06→			
35.390 FFDAK	287 kW		02/04→			
35.390 FFDAK, FFDHK, FFDHLK	287 kW		07/06→			
35.390 FFDH-TM	287 kW		07/06→			
35.390 FFNLC	287 kW		07/06→			
35.400 FDNLC	294 kW		07/06→			
35.400 FFDAK	294 kW		02/04→			
35.400 FFDAK, FFDHK, FFDHLK	294 kW		07/06→			
35.400 FFDH-TM	294 kW		07/06→			
35.400 FFNHLC	294 kW		11/06→			
35.400 FFNLC	294 kW		07/06→			
35.410 FDNLC	301 kW		07/06→			
35.410 FFDAK	301 kW		07/06→			
35.410 FFDC, FFDLC	301 kW		10/03→			
35.410 FFDK, FFDLK	301 kW		10/03→			
35.410 FFD-TM	301 kW		11/03→			
35.410 FFNLC	301 kW		07/06→			
35.430, 35.440 FFDC, FFDRC, FFDLC	316 - 324 kW		02/04→			
35.430, 35.440 FFDK, FFDRC, FFDLK	316 - 324 kW		02/04→			
35.430, 35.440 FFD-TM	316 - 324 kW		02/04→			
35.430 FDNLC	316 kW		07/06→			
35.430 FFDAK, FFDHK, FFDHLK	316 kW		07/06→			
35.430 FFDH-TM	316 kW		07/06→			
35.430 FFNLC	316 kW		07/06→			
35.440 FDNLC	324 kW		07/06→			
35.440 FFDAK, FFDHK, FFDHLK	324 kW		07/06→			
35.440 FFDH-TM	324 kW		07/06→			
35.440 FFNHLC	324 kW		11/06→			
35.440 FFNLC	324 kW		07/06→			
35.460 FFDC, FFDLC	338 kW		10/03→			
35.460 FFDK, FFDLK	338 kW		10/03→			
35.460 FFD-TM	338 kW		11/03→			
35.460 FFNLC	338 kW		07/06→			
35.480 FDNLC	353 kW		07/06→			
35.480 FFDAK	353 kW		07/06→			
35.480 FFDAK, FFDHK, FFDHLK	353 kW		07/06→			
35.480 FFDARS	353 kW		07/06→			
35.480 FFDC, FFDLC	353 kW		10/03→			
35.480 FFDC, FFDLC	353 kW		02/04→			
35.480 FFDH-TM	353 kW		07/06→			
35.480 FFDK, FFDLK	353 kW		10/03→			
35.480 FFDK, FFDLK	353 kW		02/04→			
35.480 FFD-TM	353 kW		11/03→			
35.480 FFD-TM	353 kW		02/04→			
35.480 FFNHLC	353 kW		11/06→			
35.480 FFNLC	353 kW		07/06→			
35.530 FDNLC	390 kW		04/04→			
35.530 FFDAK	390 kW		07/06→			
35.530 FFDC, FFDLC	390 kW		04/04→			
35.530 FFDK, FFDLK	390 kW		04/04→			
35.530 FFD-TM	390 kW		04/04→			
35.530 FFNLC	390 kW		07/06→			
37.310, 37.320 FFDC	228 - 235 kW		12/04→			
37.310, 37.320 FFDK	228 - 235 kW		12/04→			
37.310, 37.320 FFD-TM	228 - 235 kW		12/04→			
37.310 FFDC	228 kW		12/04→			
37.310 FFDK	228 kW		12/04→			
37.310 FFD-TM	228 kW		12/04→			
37.350, 37.360 FFDC	257 - 265 kW		12/04→			
37.350, 37.360 FFDK	257 - 265 kW		12/04→			
37.350, 37.360 FFD-TM	257 - 265 kW		12/04→			
37.360 FFDC	265 kW		12/04→			
37.360 FFDK	265 kW		12/04→			
37.360 FFD-TM	265 kW		12/04→			
37.390, 37.400 FFDC	287 - 294 kW		12/04→			

Manufacturer - Model	Power	Displ.	Year of Constr.	Remark	Part Number	Page
MAN - TGA						04/00→
37.390, 37.400 FFDK	287 - 294 kW		12/04→	Inner Diameter [mm]: 78; with lock / with key	8XY 004 734-001 Cap, fuel tank	223
37.390, 37.400 FFD-TM	287 - 294 kW		12/04→			
37.410 FFDK	301 kW		12/04→	Inner Diameter [mm]: 78; without lock; without support strap / with breather valve	8XY 007 023-001 Cap, fuel tank	223
37.410 FFD-TM	301 kW		12/04→			
37.430, 37.440 FFDK	316 - 324 kW		12/04→			
37.430, 37.440 FFD-TM	316 - 324 kW		12/04→			
37.460 FFDK	338 kW		12/04→			
37.460 FFD-TM	338 kW		12/04→			
37.480 FFDK	353 kW		12/04→			
37.480 FFD-TM	353 kW		02/06→			
37.480 FFDK	353 kW		12/04→			
37.480 FFD-TM	353 kW		02/06→			
37.530 FFDK	390 kW		12/04→			
37.530 FFD-TM	390 kW		12/04→			
37.530 FVDS, FVDLS	390 kW		07/06→			
39.390 FVNLC	287 kW		07/06→			
39.400 FVNLC	294 kW		07/06→			
39.430 FVNLC	316 kW		07/06→			
39.440 FVNLC	324 kW		07/06→			
39.480 FVNLC	353 kW		07/06→			
40.390, 40.400 FDAK-WW	287 - 294 kW		06/05→			
40.390, 40.400 FDAS-WW	287 - 294 kW		06/05→			
40.390, 40.400 FDK-WW, FDRK	287 - 294 kW		06/05→			
40.390, 40.400 FDS-WW, FDRS	287 - 294 kW		06/05→			
40.410 FDAK-WW	301 kW		04/04→			
40.410 FDAS-WW	301 kW		04/04→			
40.410 FDK-WW	301 kW		04/04→			
40.410 FDS-WW	301 kW		04/04→			
40.430, 40.440 FDAK-WW	316 - 324 kW		06/05→			
40.430, 40.440 FDAS-WW	316 - 324 kW		06/05→			
40.430 FDK-WW, FDRK	316 kW		06/05→			
40.430 FDS-WW, FDRS	316 kW		06/05→			
40.440 FDAK-WW	324 kW		06/05→			
40.440 FDAS-WW	324 kW		06/05→			
40.440 FDK-WW, FDRK	324 kW		06/05→			
40.440 FDS-WW, FDRS	324 kW		06/05→			
40.460 FDAK-WW	338 kW		04/04→			
40.460 FDAS-WW	338 kW		04/04→			
40.460 FDK-WW	338 kW		04/04→			
40.460 FDS-WW	338 kW		04/04→			
40.480 FDAK-WW	353 kW		04/04→			
40.480 FDK-WW	353 kW		06/05→			
40.480 FDAS-WW	353 kW		04/04→			
40.480 FDS-WW	353 kW		06/05→			
40.480 FDK-WW	353 kW		04/04→			
40.480 FDK-WW, FDRK	353 kW		06/05→			
40.480 FDS-WW	353 kW		04/04→			
40.480 FDS-WW; FDRS	353 kW		06/05→			
41.350, 41.360 FFDK, FFDRC, FFDRC	257 - 265 kW		12/04→			
41.350, 41.360 FFDK, FFDRC	257 - 265 kW		12/04→			
41.350, 41.360 FFD-TM	257 - 265 kW		12/04→			
41.350 FFDK-TM, FFDRC-TM	257 kW		09/07→			
41.360 FFD	265 kW		12/08→			
41.360 FFDK, FFDRC, FFDRC/M, FFDRC	265 kW		01/03→			
41.360 FFDK-TM, FDRK-TM	265 kW		09/07→			
41.360 FFDK-WW	265 kW		09/03→			
41.360 FFD-TM	265 kW		12/04→			
41.390, 41.400 FFDK, FFDRC, FFDRC/M	287 - 294 kW		12/04→			
41.390, 41.400 FFDK, FFDRC	287 - 294 kW		12/04→			
41.390, 41.400 FFD-TM	287 - 294 kW		12/04→			
41.390 FFDK	287 kW		12/04→			
41.390 FFDK-TM, FDRK-TM	287 kW		09/07→			
41.400 FFD	294 kW		12/08→			
41.400 FFDK-TM, FDRK-TM	294 kW		09/07→			
41.410 FFDK	301 kW		07/06→			
41.410 FFDK-WW, FDRK	301 kW		09/03→			
41.410 FFDK-WW	301 kW		09/03→			
41.410 FFD-TM	301 kW		12/04→			
41.430, 41.440 FFDK, FFDRC, FFDRC/M	316 - 324 kW		12/04→			
41.430, 41.440 FFDK, FFDRC	316 - 324 kW		12/04→			
41.430, 41.440 FFD-TM	316 - 324 kW		12/04→			

Manufacturer - Model	Power	Displ.	Year of Constr.	Remark	Part Number	Page
MAN - TGA						04/00→
41.430 FFDK	316 kW		12/04→	Inner Diameter [mm]: 78; with lock / with key	8XY 004 734-001 Cap, fuel tank	223
41.430 FFDK	316 kW		07/06→			
41.430 FFDC-TM, FFDC	316 kW		09/07→	Inner Diameter [mm]: 78; without lock; without support strap / with breather valve	8XY 007 023-001 Cap, fuel tank	223
41.440 FFD/M	324 kW		12/04→			
41.440 FFDK	324 kW		07/06→			
41.440 FFDC, FFDC	324 kW		12/04→			
41.440 FFDC-TM, FFDC-TM	324 kW		09/07→			
41.440 FFDK, FFDRK	324 kW		12/04→			
41.460 FFDC-WW, FFDC	338 kW		09/03→			
41.460 FFDK-WW	338 kW		09/03→			
41.460 FFD-TM	338 kW		12/04→			
41.480 FFD	353 kW		12/08→			
41.480 FFDK	353 kW		07/06→			
41.480 FFDARC	353 kW		07/06→			
41.480 FFDC, FFDC, FFDC/M	353 kW		02/06→			
41.480 FFDC-TM, FFDC-TM	353 kW		09/07→			
41.480 FFDC-WW, FFDC	353 kW		06/05→			
41.480 FFDK, FFDRK	353 kW		02/06→			
41.480 FFDK-WW	353 kW		06/05→			
41.480 FFD-TM	353 kW		12/04→			
41.480 FFD-TM	353 kW		02/06→			
41.480 FVDS, FVDLS	353 kW		07/06→			
41.530 FFDK	353 kW		07/06→			
41.530 FFDK	390 kW		07/06→			
41.530 FFDC	390 kW		12/04→			
41.530 FFDK	390 kW		12/04→			
41.530 FFD-TM	390 kW		12/04→			
41.530 FVDS, FVDLS	390 kW		09/02→			
41.540 FVDS, FVDLS	397 kW		11/06→			
41.660 FVDS, FVDLS	485 kW		09/02→			



ATLAS COPCO	HELLA
5051252500	8XY 007 023-001
8130665	8XY 007 023-001
DAF	HELLA
087 9737	8XY 004 734-001
MAN	HELLA
90.80030.1107	8XY 004 734-001
MERCEDES- BENZ	HELLA
000 471 12 30	8XY 004 734-001
A 000 471 12 30	8XY 004 734-001



8XY ...	
8XY 004 734-001	223
8XY 007 023-001	223



Starter.....	255
--------------	-----

Starter

8EA 726 022-001
CS191



Flange Ø [mm]	92
Number of mounting bores	3
Number of Teeth	9
Number of Thread Bores	0
Rated Power [kW]	5.4
Rotation Direction	Clockwise rotation
Terminal/Clamp	with 50(Jet) clamp
Voltage [V]	24

8EA 726 025-001
CS198



Flange Ø [mm]	92
Number of mounting bores	3
Number of Teeth	9
Number of Thread Bores	0
Rated Power [kW]	6
Rotation Direction	Clockwise rotation
Terminal/Clamp	with 50(Jet) clamp
Voltage [V]	24

Starter

8EA 726 038-001
CS269

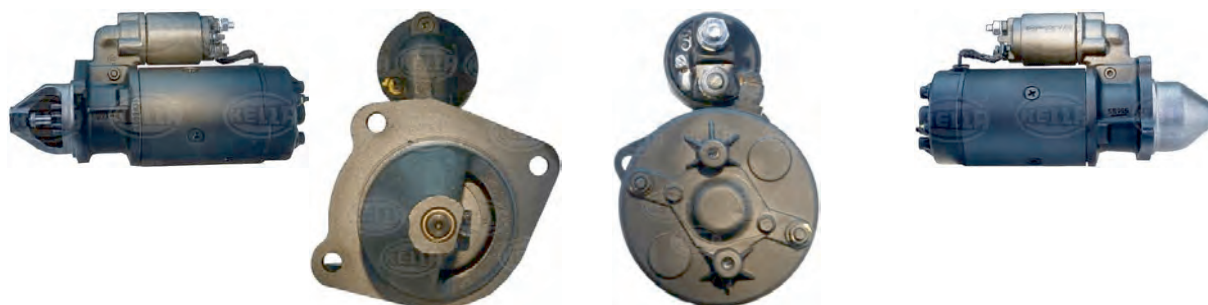

Flange Ø [mm]	89
Number of mounting bores	3
Number of Teeth	10
Number of Thread Bores	0
Rated Power [kW]	4
Rotation Direction	Clockwise rotation
Terminal/Clamp	with 50(Jet) clamp
Voltage [V]	24

8EA 726 219-001
CS595

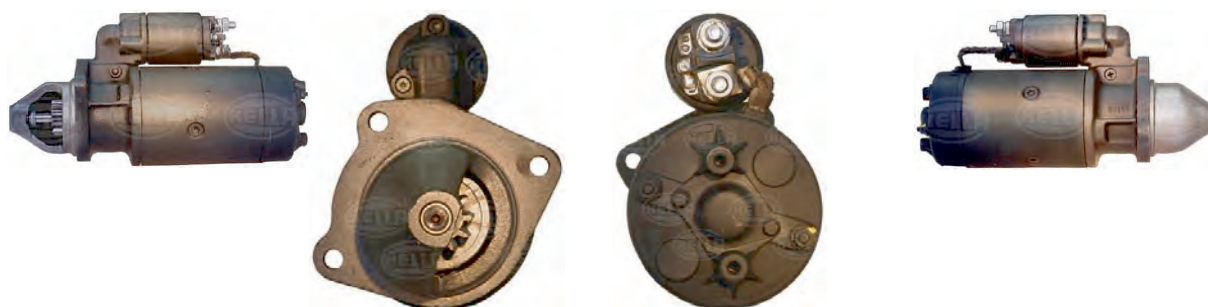

Flange Ø [mm]	89
Number of mounting bores	3
Number of Teeth	11
Number of Thread Bores	0
Rated Power [kW]	4
Rotation Direction	Clockwise rotation
Terminal/Clamp	with 50(Jet) clamp
Voltage [V]	24

Starter

8EA 737 912-001
CS1243



Flange Ø [mm]	89
Number of mounting bores	3
Number of Teeth	11
Number of Thread Bores	0
Rated Power [kW]	4
Rotation Direction	Clockwise rotation
Terminal/Clamp	with 50(Jet) clamp
Transmission Type	with reduction gear
Voltage [V]	24

8EA 738 029-001
CS1267



Flange Ø [mm]	89
Number of mounting bores	3
Number of Teeth	10
Number of Thread Bores	0
Rated Power [kW]	4
Rotation Direction	Clockwise rotation
Terminal/Clamp	with 50(Jet) clamp
Transmission Type	with reduction gear
Voltage [V]	24



MAN.....259

Manufacturer - Model	Power	Displ.	Year of Constr.	Remark	Part Number	Page
MAN - Cab-over Trucks						07/86→05/94
19.322 U, 19.322 UL, 19.322 ULL	235 kW		02/90→05/94	☺ D2865LF03; 5.4kW	8EA 726 022-001	Starter 255
				☺ D2865LF03; 6kW	8EA 726 025-001	Starter 255
				☺ D2865LF06; 6kW	8EA 726 025-001	Starter 255
19.332 U, 19.322 UL, 19.322 ULL 24.332 UNL, 24.332 UNLL	243 kW 243 kW		07/86→02/90 10/86→02/90	☺ D2866LUL/330; 5.4kW	8EA 726 022-001	Starter 255
19.362 U, 19.362 UL, 19.362 ULL 24.362 UNL, 24.362 UNLL	265 kW 265 kW		07/86→01/91 10/86→02/90	☺ D2866KUL; 5.4kW	8EA 726 022-001	Starter 255
19.372 U, 19.372 ULL	272 kW		02/90→05/94	☺ D2866LF03; 5.4kW	8EA 726 022-001	Starter 255
				02/90→; →11/92; ☺ D2866LF05; 5.4kW	8EA 726 022-001	Starter 255
				☺ D2866LF03; 6kW	8EA 726 025-001	Starter 255
19.422 U, 19.422 ULL	309 kW		02/90→05/94	02/90→; →11/90; ☺ D2866LF06; 5.4kW	8EA 726 022-001	Starter 255
				02/90→; →11/92; ☺ D2866LF09; 5.4kW	8EA 726 022-001	Starter 255
24.322 UNL, 24.322 UNLL	235 kW		02/90→12/90	☺ D2865LF03; 5.4kW	8EA 726 022-001	Starter 255
				☺ D2865LF03; 6kW	8EA 726 025-001	Starter 255
24.372 UNL, 24.372 UNLL	272 kW		02/90→12/90	☺ D2866LF03; 5.4kW	8EA 726 022-001	Starter 255
24.422 UNL, 24.422 UNLL	309 kW		02/90→12/90	☺ D2866LF06; 5.4kW	8EA 726 022-001	Starter 255
25.322 UNL, 25.322 UNLL	235 kW		09/90→12/92	09/90→; →11/91; ☺ D2865LF03; 5.4kW	8EA 726 022-001	Starter 255
				☺ D2865LF06; 5.4kW	8EA 726 022-001	Starter 255
				☺ D2865LF03; 6kW	8EA 726 025-001	Starter 255
				☺ D2865LF06; 6kW	8EA 726 025-001	Starter 255
25.372 UNL, 25.372 UNLL	272 kW		09/90→12/92	☺ D2866LF05; 5.4kW	8EA 726 022-001	Starter 255
				☺ D2866LF03; 5.4kW	8EA 726 022-001	Starter 255
25.422 UNL, 25.422 UNLL	309 kW		09/90→12/92	09/90→; →11/90; ☺ D2866LF06; 5.4kW	8EA 726 022-001	Starter 255
				☺ D2866LF09; 5.4kW	8EA 726 022-001	Starter 255
26.322 UNL, 26.322 UNLL	235 kW		09/90→05/94	☺ D2865LF06; 5.4kW	8EA 726 022-001	Starter 255
				☺ D2865LF03; 5.4kW	8EA 726 022-001	Starter 255
				☺ D2865LF03; 6kW	8EA 726 025-001	Starter 255
				☺ D2865LF06; 6kW	8EA 726 025-001	Starter 255
26.372 UNL, 26.372 UNLL	272 kW		09/90→05/94	☺ D2866LF03; 5.4kW	8EA 726 022-001	Starter 255
				09/90→; →11/92; ☺ D2866LF05; 5.4kW	8EA 726 022-001	Starter 255
26.422 UNL, 26.422 UNLL	309 kW		09/90→05/94	09/90→; →11/90; ☺ D2866LF06; 5.4kW	8EA 726 022-001	Starter 255
				09/90→; →11/92; ☺ D2866LF09; 5.4kW	8EA 726 022-001	Starter 255
MAN - E 2000						05/00→
19.310 FALK 19.310 FALS 30.310 FNLC 32.310 VFLC 32.310 VFNLC	228 kW 228 kW 228 kW 228 kW 228 kW		05/00→ 05/00→ 05/00→ 05/00→ 05/00→	☺ D2866LF23; 5.4kW	8EA 726 022-001	Starter 255
19.360 FALK 19.360 FALS 19.360 FLS 28.360 FNALC 32.360 VFNLC 33.360 DFAK, DFALK 33.360 DFALC 33.360 DFALS 33.360 DFLS 35.360 VFAK	265 kW 265 kW 265 kW 265 kW 265 kW 265 kW 265 kW 265 kW 265 kW 265 kW		05/00→ 05/00→ 05/00→ 05/00→ 05/00→ 05/00→ 05/00→ 04/01→ 05/00→ 05/00→	☺ D2866LF24; 5.4kW	8EA 726 022-001	Starter 255
19.410 FALK 32.410 VFARK 33.410 DFALS 33.410 DFLS 35.410 VFAK 41.410 VFAK 50.410 VFAVK, VFAV-G 50.410 VFVK, VFV-G	301 kW 301 kW 301 kW 301 kW 301 kW 301 kW 301 kW 301 kW		05/00→ 05/00→ 04/01→ 05/00→ 05/00→ 05/00→ 03/01→ 10/00→	☺ D2866LF25; 5.4kW	8EA 726 022-001	Starter 255
19.460 FALK 19.460 FALS 19.460 FLK 19.460 FLS 26.460 DFARC 26.460 DFLRS 26.460 FAVLC 26.460 FAVLK 28.460 FANLC 28.460 FANLK 28.460 FNLC 29.460 FVAS 30.460 FANLC 30.460 FANLK 32.460 VFCL, VFLLC 32.460 VFNLC 33.460 DFAK, DFALK	338 kW 338 kW 338 kW 338 kW 338 kW 338 kW 338 kW 338 kW 338 kW 338 kW 338 kW 338 kW 338 kW 338 kW 338 kW 338 kW 338 kW		05/00→ 05/00→ 05/00→ 05/00→ 05/00→ 05/00→ 05/00→ 05/00→ 05/00→ 05/00→ 05/00→ 05/00→ 05/00→ 05/00→ 05/00→ 05/00→ 05/00→	☺ D2876LF03; 5.4kW	8EA 726 022-001	Starter 255

Manufacturer - Model	Power	Displ.	Year of Constr.	Remark	Part Number	Page
MAN - E 2000						05/00→
33.460 DFALC	338 kW		05/00→	☺ D2876LF03; 5.4kW	8EA 726 022-001 Starter 255	
33.460 DFALS	338 kW		04/01→			
33.460 DFCL	338 kW		05/00→			
33.460 DFLK	338 kW		05/00→			
33.460 DFSL	338 kW		05/00→			
35.460 FVNLC	338 kW		05/00→			
35.460 VFAK	338 kW		05/00→			
41.460 DFVS, DFVLS	338 kW		06/00→			
41.460 VFAK	338 kW		05/00→			
50.460 VFAK	338 kW		05/00→			
50.460 VFAVK, VFAV-G	338 kW		03/01→			
50.460 VFK	338 kW		05/00→			
50.460 VFVK, VFV-G	338 kW		10/00→			
33.600 DFALS, DFAS	441 kW		06/00→	☺ D2840LF21; 6kW	8EA 726 025-001 Starter 255	
33.600 DFSL	441 kW		06/00→			
40.600 DFAS	441 kW		06/00→			
41.600 DFVS, DFVLS	441 kW		06/00→			
50.600 VFAS	441 kW		05/00→			
MAN - EL						01/93→
EL 202,EL 222	157 - 169 kW		01/93→06/97	☺ D0826LUH12; 5.4kW	8EA 726 022-001 Starter 255	
				☺ D0826LUH03; 5.4kW	8EA 726 022-001 Starter 255	
				☺ D0826LUH05; 5.4kW	8EA 726 022-001 Starter 255	
				☺ D0826LUH03; 4kW	8EA 726 219-001 Starter 256	
				☺ D0826LUH05; 4kW	8EA 726 219-001 Starter 256	
				☺ D0826LUH12; 4kW	8EA 726 219-001 Starter 256	
EL 202,EL 262	184 kW		04/94→06/97	☺ D0826LUH; 4kW	8EA 726 219-001 Starter 256	
EL 262	191 kW		07/98→	☺ 07/98→; →09/01; ☺ D2866LUH22; 5.4kW	8EA 726 022-001 Starter 255	
				☺ 07/98→; →09/01; ☺ D2866LUH22; 6kW	8EA 726 025-001 Starter 255	
MAN - EM						08/87→
EM 192	140 kW		10/93→06/97	☺ D0826LOH06; 5.4kW	8EA 726 022-001 Starter 255	
				☺ D0826LOH06; 4kW	8EA 726 219-001 Starter 256	
				☺ D0826LOH06; 4kW	8EA 738 029-001 Starter 257	
EM 222,EM 223	162 kW		02/96→	☺ 02/96→; →09/01; ☺ D0826LOH15; 5.4kW	8EA 726 022-001 Starter 255	
				☺ 02/96→; →09/01; ☺ D0826LUH12; 5.4kW	8EA 726 022-001 Starter 255	
				☺ 02/96→; →09/01; ☺ D0826LUH12; 4kW	8EA 726 219-001 Starter 256	
				☺ 02/00→; →09/01; ☺ D0826LUH12; 4kW	8EA 737 912-001 Starter 257	
				☺ 06/00→; →09/01; ☺ D0826LOH15; 4kW	8EA 737 912-001 Starter 257	
				☺ 02/96→; →09/01; ☺ D0826LUH12; 4kW	8EA 738 029-001 Starter 257	
EM 223	162 kW		08/87→	☺ 02/96→; →09/01; ☺ D0826LOH15; 5.4kW	8EA 726 022-001 Starter 255	
				☺ 07/01→; →09/01; ☺ D0826LOH15; 4kW	8EA 726 038-001 Starter 256	
				☺ 06/00→; →09/01; ☺ D0826LOH15; 4kW	8EA 737 912-001 Starter 257	
				☺ 02/96→; →06/01; ☺ D0826LOH15; 4kW	8EA 738 029-001 Starter 257	
MAN - F 9						01/83→12/86
15.192 F, 15.192 FL	141 kW		01/83→12/86	☺ D2565MF; 5.4kW	8EA 726 022-001 Starter 255	
15.192 FS	141 kW		01/83→12/86			
MAN - F 90						07/86→12/97
19.242 F,19.242 FL,19.242 FLL	177 kW		01/88→01/89	☺ D2866F/240; 5.4kW	8EA 726 022-001 Starter 255	
19.242 FK	177 kW		01/88→02/89			
19.242 FS,19.242 FLS,19.242 FLLS	177 kW		01/88→01/89			
33.242 DFAK	177 kW		01/88→08/88			
33.242 DFK	177 kW		01/88→08/88			
19.262 F,19.262 FL,19.262 FLL	191 kW		01/88→02/90	☺ D2865LF/260; 5.4kW	8EA 726 022-001 Starter 255	
19.262 FA	191 kW		02/89→02/90	☺ D2865LF/260; 6kW	8EA 726 025-001 Starter 255	
19.262 FAK	191 kW		02/89→02/90			
19.262 FAS	191 kW		02/89→02/90			
19.262 FK	191 kW		01/88→02/90			
19.262 FS,19.262 FLS,19.262 FLLS	191 kW		01/88→02/90			
24.262 DF	191 kW		01/88→02/90			
24.262 DFK	191 kW		01/88→02/90			
24.262 DFS,24.262 DFSL	191 kW		01/88→02/90			
24.262 FNL,24.262 FNLL,24.262 FVL	191 kW		01/88→02/90			
26.262 DF	191 kW		01/88→02/90			
26.262 DFA	191 kW		02/89→02/90			
26.262 DFAK	191 kW		02/89→02/90			
26.262 DFAS	191 kW		02/89→02/90			
26.262 DFK	191 kW		01/88→02/90			
26.262 DFS	191 kW		01/88→02/90			
32.262 VF	191 kW		02/89→02/90			

Manufacturer - Model	Power	Displ.	Year of Constr.	Remark	Part Number	Page
MAN - F 90						07/86→12/97
32.262 VFK	191 kW		02/89→02/90	☞ D2865LF/260; 5.4kW	8EA 726 022-001	Starter 255
32.262 VFTM	191 kW		02/89→02/90	☞ D2865LF/260; 6kW	8EA 726 025-001	Starter 255
33.262 DF	191 kW		08/88→02/90			
33.262 DFA	191 kW		07/89→02/90			
33.262 DFAK	191 kW		07/89→02/90			
33.262 DFK	191 kW		08/88→02/90			
35.262 VF	191 kW		02/89→02/90			
35.262 VFA	191 kW		07/89→02/90			
35.262 VFK	191 kW		02/89→02/90			
41.262 VF	191 kW		07/89→02/90			
41.262 VFK	191 kW		07/89→02/90			
19.272 F, 19.272 FL, 19.272 FLL	198 kW		02/90→05/95	☞ D2865LF05; 5.4kW	8EA 726 022-001	Starter 255
24.272 FNL, 24.272 FNLL, 24.272 FVL	198 kW		02/90→05/95	☞ D2865LF02; 5.4kW	8EA 726 022-001	Starter 255
24.272 FNLS, 24.272 FVLS	198 kW		02/90→05/95	☞ D2865LF02; 6kW	8EA 726 025-001	Starter 255
25.272 DF	198 kW		09/90→12/92	☞ D2865LF05; 6kW	8EA 726 025-001	Starter 255
25.272 DFK	198 kW		09/90→12/92			
25.272 DFS, 25.272 DFLS	198 kW		09/90→12/92			
25.272 FNL, 25.272 FNLL, 25.272 FVL	198 kW		09/90→10/93			
26.272 DFA	198 kW		02/90→12/92			
26.272 DFAK	198 kW		02/90→12/92			
26.272 DFAS	198 kW		02/90→12/92			
32.272 VF	198 kW		02/90→04/95			
32.272 VFK	198 kW		02/90→04/95			
19.272 FA	198 kW		02/90→05/95	☞ D2865LF05; 5.4kW	8EA 726 022-001	Starter 255
			02/90→; →11/91; ☞ D2865LF02; 5.4kW	8EA 726 022-001	Starter 255	
				☞ D2865LF02; 6kW	8EA 726 025-001	Starter 255
				☞ D2865LF05; 6kW	8EA 726 025-001	Starter 255
19.272 FAK	198 kW		02/90→05/95	☞ D2865LF02; 5.4kW	8EA 726 022-001	Starter 255
19.272 FAS	198 kW		02/90→05/95	02/90→; →11/92; ☞ D2865LF05; 5.4kW	8EA 726 022-001	Starter 255
19.272 FK	198 kW		02/90→05/95	☞ D2865LF02; 6kW	8EA 726 025-001	Starter 255
19.272 FS, 19.272 FLS, 19.272 FLLS	198 kW		02/90→05/95	☞ D2865LF05; 6kW	8EA 726 025-001	Starter 255
19.292 F, 19.292 FL, 19.292 FLL	213 kW		07/86→02/90	☞ D2866LF/290; 5.4kW	8EA 726 022-001	Starter 255
19.292 FA	213 kW		05/88→02/90			
19.292 FAK	213 kW		05/88→02/90			
19.292 FAS	213 kW		05/88→02/90			
19.292 FK	213 kW		07/86→02/90			
19.292 FS, 19.292 FLS, 19.292 FLLS	213 kW		07/86→02/90			
24.292 DF	213 kW		04/87→02/90			
24.292 DFK	213 kW		04/87→02/90			
24.292 DFS, 24.292 DFLS	213 kW		04/87→02/90			
24.292 FNL, 24.292 FNLL, 24.292 FVL	213 kW		10/86→02/90			
24.292 FNLS, 24.292 FVLS	213 kW		10/86→02/90			
26.292 DF, 26.292 DFL	213 kW		09/87→02/90			
26.292 DFA	213 kW		05/88→02/90			
26.292 DFAK	213 kW		05/88→02/90			
26.292 DFAS	213 kW		05/88→02/90			
26.292 DFK	213 kW		09/87→02/90			
26.292 DFS	213 kW		09/87→02/90			
32.292 VF	213 kW		03/88→02/90			
32.292 VFK	213 kW		03/88→02/90			
33.292 DF	213 kW		09/87→02/90			
33.292 DFA	213 kW		05/88→02/90			
33.292 DFAK	213 kW		05/88→02/90			
33.292 DFAS	213 kW		05/88→02/90			
33.292 DFK	213 kW		09/87→02/90			
33.292 DFS	213 kW		09/87→02/90			
41.292 VF	213 kW		10/88→02/90			
41.292 VFK	213 kW		10/88→02/90			
48.292 VF	213 kW		07/89→02/90			
48.292 VFA	213 kW		07/89→02/90			
48.292 VFAK	213 kW		07/89→02/90			
19.322 F, 19.322 FL, 19.322 FLL	235 kW		02/90→05/95	☞ D2865LF06; 5.4kW	8EA 726 022-001	Starter 255
19.322 FK	235 kW		02/90→05/95	☞ D2865LF03; 5.4kW	8EA 726 022-001	Starter 255
19.322 FS, 19.322 FLS, 19.322 FLLS	235 kW		02/90→05/95	☞ D2865LF03; 6kW	8EA 726 025-001	Starter 255
25.322 DF, 25.322 DFL	235 kW		09/90→12/92	☞ D2865LF06; 6kW	8EA 726 025-001	Starter 255
25.322 DFK	235 kW		09/90→12/92			
25.322 DFS, 25.322 DFLS	235 kW		09/90→12/92			
25.322 FNL, 25.322 FNLL, 25.322 FVL	235 kW		09/90→12/92			
25.322 FNLS, 25.322 FVLS	235 kW		09/90→12/92			

Manufacturer - Model	Power	Displ.	Year of Constr.	Remark	Part Number	Page
MAN - F 90						07/86→12/97
19.322 FA	235 kW		02/90→06/96	D2865LF03; 6kW	8EA 726 025-001	Starter 255
19.322 FAK	235 kW		02/90→06/96	D2865LF06; 6kW	8EA 726 025-001	Starter 255
19.322 FAS	235 kW		02/90→06/96			
26.322 DFK	235 kW		02/92→06/96			
26.322 DFS,26.322 DFLS	235 kW		02/90→06/96			
33.322 DF	235 kW		09/91→06/96			
33.322 DFA	235 kW		09/91→06/96			
33.322 FVL	235 kW		09/91→06/96			
35.322 VFAK	235 kW		02/90→06/96			
19.332 F,19.332 FL,19.332 FLL	243 kW		07/86→02/90	D2866LF/330; 5.4kW	8EA 726 022-001	Starter 255
19.332 FA	243 kW		05/88→02/90			
19.332 FAK	243 kW		05/88→02/90			
19.332 FAS	243 kW		05/88→02/90			
19.332 FS,19.332 FLS,19.332 FLLS	243 kW		07/86→02/90			
24.332 DF	243 kW		04/87→02/90			
24.332 DFK	243 kW		04/87→02/90			
24.332 DFS,24.332 DFLS	243 kW		04/87→02/90			
24.332 FNL,24.332 FNLL,24.332 FVL	243 kW		10/86→02/90			
24.332 FNLS,24.332 FVLS	243 kW		10/86→02/90			
26.332 DF, 26.332 DFL	243 kW		09/87→02/90			
26.332 DFA	243 kW		05/88→02/90			
26.332 DFAK	243 kW		05/88→02/90			
26.332 DFAS	243 kW		05/88→02/90			
26.332 DFK	243 kW		09/87→02/90			
26.332 DFS	243 kW		09/87→02/90			
32.332 VF	243 kW		03/88→02/90			
32.332 VFK	243 kW		03/88→02/90			
33.332 DF	243 kW		09/87→02/90			
33.332 DFA	243 kW		05/88→02/90			
33.332 DFAK	243 kW		05/88→02/90			
33.332 DFAS	243 kW		05/88→02/90			
33.332 DFK	243 kW		09/87→02/90			
33.332 DFS	243 kW		09/87→02/90			
41.332 VF	243 kW		10/88→02/90			
41.332 VFK	243 kW		10/88→02/90			
48.332 VF	243 kW		07/89→02/90			
48.332 VFA	243 kW		07/89→02/90			
48.332 VFAK	243 kW		07/89→02/90			
19.342 F,19.342 FL,19.342 FLL	250 kW		05/94→05/95	D2865LF09; 5.4kW	8EA 726 022-001	Starter 255
19.342 FK	250 kW		05/94→05/95	D2865LF09; 6kW	8EA 726 025-001	Starter 255
19.342 FS,19.342 FLS,19.342 FLLS	250 kW		05/94→05/95			
24.342 FNL,24.342 FNLL	250 kW		05/94→05/95			
19.342 FA	250 kW		05/94→06/96	D2865LF09; 6kW	8EA 726 025-001	Starter 255
19.342 FAK	250 kW		05/94→06/96			
19.342 FAS	250 kW		05/94→06/96			
26.342 DF,26.342 DFL	250 kW		05/94→06/96			
26.342 DFK,26.342 DFLK	250 kW		05/94→06/96			
26.342 DFS	250 kW		04/94→06/96			
32.342 VFK	250 kW		05/94→06/96			
33.342 DF	250 kW		05/94→06/96			
33.342 DFA	250 kW		05/94→06/96			
35.342 VF	250 kW		05/94→06/96			
35.342 VFK	250 kW		05/94→06/96			
41.342 VF	250 kW		05/94→06/96			
19.362 F,19.362 FL,19.362 FLL	265 kW		07/86→02/90	D2866KF; 5.4kW	8EA 726 022-001	Starter 255
19.362 FK	265 kW		07/86→02/90	D2866LXF; 5.4kW	8EA 726 022-001	Starter 255
19.362 FS,19.362 FLS,19.362 FLLS	265 kW		07/86→02/90			
24.362 DF	265 kW		04/87→02/90			
24.362 DFK	265 kW		04/87→02/90			
24.362 DFS,24.362 DFLS	265 kW		04/87→02/90			
24.362 FNL,24.362 FNLL,24.362 FVL	265 kW		10/86→02/90			
24.362 FNLS,24.362 FVLS	265 kW		10/86→02/90			
26.362 DF, 26.362 DFL	265 kW		09/87→02/90			
26.362 DFK	265 kW		09/87→02/90			
26.362 DFS	265 kW		09/87→02/90			
33.362 DF	265 kW		09/87→02/90			
33.362 DFK	265 kW		09/87→02/90			
33.362 DFS	265 kW		09/87→02/90			
19.362 FA	265 kW		05/88→02/90	D2866LXF; 5.4kW	8EA 726 022-001	Starter 255
19.362 FAK	265 kW		05/88→02/90			
19.362 FAS	265 kW		05/88→02/90			
26.362 DFA	265 kW		05/88→02/90			
26.362 DFAK	265 kW		05/88→02/90			
26.362 DFAS	265 kW		05/88→02/90			

Manufacturer - Model	Power	Displ.	Year of Constr.	Remark	Part Number	Page			
MAN - F 90						07/86→12/97			
32.362 VF	265 kW		03/88→02/90	☺ D2866LXF ; 5.4kW	8EA 726 022-001	Starter 255			
32.362 VFK	265 kW		03/88→02/90						
33.362 DFA	265 kW		05/88→02/90						
33.362 DFAK	265 kW		05/88→02/90						
33.362 DFAS	265 kW		05/88→02/90						
35.362 VF	265 kW		10/88→02/90						
35.362 VFK	265 kW		10/88→02/90						
41.362 VF	265 kW		10/88→02/90						
41.362 VFK	265 kW		10/88→02/90						
48.362 VF	265 kW		07/89→02/90						
48.362 VFA	265 kW		07/89→02/90						
48.362 VFAK	265 kW		07/89→02/90						
19.372 F,19.372 FL,19.372 FLL	249 kW		05/90→04/95				☺ D2866LXF/SILENT ; 5.4kW	8EA 726 022-001	Starter 255
19.372 FK	249 kW		05/90→04/95						
19.372 FS,19.372 FLS,19.372 FLLS	249 kW		05/90→04/95						
32.372 VFK	249 kW		05/90→04/95						
19.372 F,19.372 FL,19.372 FLL	272 kW		02/90→05/95	☺ D2866LF05 ; 5.4kW	8EA 726 022-001	Starter 255			
19.372 FK	272 kW		02/90→05/95						
19.372 FS,19.372 FLS,19.372 FLLS	272 kW		02/90→05/95						
19.372 FS,19.372 FLS,19.372 FLLS	272 kW		02/90→05/95						
19.372 F,19.372 FL,19.372 FLL	272 kW		02/90→05/95	☺ D2866LF15 ; 5.4kW	8EA 726 022-001	Starter 255			
19.372 FK	272 kW		02/90→05/95						
19.372 FS,19.372 FLS,19.372 FLLS	272 kW		02/90→05/95						
19.372 FS,19.372 FLS,19.372 FLLS	272 kW		02/90→05/95						
19.372 FA	272 kW		02/90→06/96	☺ D2866LF03 ; 5.4kW	8EA 726 022-001	Starter 255			
19.372 FAK	272 kW		02/90→06/96						
19.372 FAS	272 kW		02/90→06/96						
40.372 DF	272 kW		12/91→06/96						
40.372 DFA	272 kW		12/91→06/96	☺ D2866LF05 ; 5.4kW	8EA 726 022-001	Starter 255			
19.402 F,19.402 FL,19.402 FLL	294 kW		05/94→05/95						
19.402 FS,19.402 FLS,19.402 FLLS	294 kW		05/94→05/95						
24.402 FNL,24.402 FNLL	294 kW		05/94→05/95						
26.402 DFS	294 kW		05/94→12/95	☺ D2866LF16 ; 5.4kW	8EA 726 022-001	Starter 255			
19.402 FA	294 kW		05/94→06/96						
19.402 FAK	294 kW		05/94→06/96						
19.402 FAS	294 kW		05/94→06/96						
26.402 DF,26.402 DFL	294 kW		05/94→06/96						
26.402 DFK,26.402 DFLK	294 kW		05/94→06/96						
26.402 FNL,26.402 FNLL,26.402 FVL	294 kW		05/94→06/96						
26.402 FNL,26.402 FNLL,26.402 FVL	294 kW		05/94→06/96						
32.402 VFK	294 kW		05/94→06/96						
33.402 DF	294 kW		05/94→06/96						
33.402 DFA	294 kW		05/94→06/96						
33.402 DFAK	294 kW		05/94→06/96						
33.402 DFK	294 kW		05/94→06/96						
33.402 DFS	294 kW		05/94→06/96						
35.402 VF	294 kW		05/94→06/96						
35.402 VFK	294 kW		05/94→06/96						
40.402 DF	294 kW		05/95→06/96						
40.402 DFA	294 kW		05/95→06/96						
19.402 FK	294 kW		05/94→05/95	☺ D2866LF16 ; 5.4kW	8EA 726 022-001	Starter 255			
19.422 F,19.422 FL,19.422 FLL	309 kW		02/90→05/95						
19.422 F,19.422 FL,19.422 FLL	309 kW		02/90→05/95						
19.422 F,19.422 FL,19.422 FLL	309 kW		02/90→05/95	☺ D2866LF10 ; 5.4kW	8EA 726 022-001	Starter 255			
19.422 F,19.422 FL,19.422 FLL	309 kW		02/90→05/95						
19.422 F,19.422 FL,19.422 FLL	309 kW		02/90→05/95						
19.422 FA	309 kW		02/90→06/96	☺ D2866LF09 ; 5.4kW	8EA 726 022-001	Starter 255			
19.422 FAK	309 kW		02/90→06/96						
19.422 FAS	309 kW		02/90→06/96						
26.422 DFA	309 kW		02/90→12/92	☺ D2866LF06 ; 5.4kW	8EA 726 022-001	Starter 255			
26.422 DFAK	309 kW		02/90→12/92						
26.422 DFAS	309 kW		02/90→12/92						
33.422 DF	309 kW		09/91→06/96						
33.422 DFA	309 kW		09/91→06/96						
33.422 DFAK	309 kW		01/94→06/96						
33.422 DFK	309 kW		01/94→06/96						
33.422 DFS	309 kW		01/94→06/96						
40.422 DF	309 kW		12/91→06/96						
40.422 DFA	309 kW		12/91→06/96						
19.422 FK	309 kW		02/90→05/95				☺ D2866LF09 ; 5.4kW	8EA 726 022-001	Starter 255
19.422 FK	309 kW		02/90→05/95						
19.422 FK	309 kW		02/90→05/95						
19.422 FS,19.422 FLS,19.422 FLLS	309 kW		02/90→05/95				☺ D2866LF06 ; 5.4kW	8EA 726 022-001	Starter 255
19.422 FS,19.422 FLS,19.422 FLLS	309 kW		02/90→05/95						
19.422 FS,19.422 FLS,19.422 FLLS	309 kW		02/90→05/95						
19.462 F,19.462 FL	338 kW		05/87→02/90	☺ D2840LF/460 ; 6kW	8EA 726 025-001	Starter 255			
19.462 FK	338 kW		05/87→02/90						
19.462 FS,19.462 FLS	338 kW		05/87→02/90						
24.462 DF	338 kW		02/89→02/90						
24.462 DFS	338 kW		02/89→02/90						
24.462 FNL	338 kW		04/89→02/90						
24.462 FNL	338 kW		04/89→02/90						

Manufacturer - Model	Power	Displ.	Year of Constr.	Remark	Part Number	Page
MAN - F 90						07/86→12/97
24.462 FVLS	338 kW		05/87→07/87	☺ D2840LF/460; 6kW	8EA 726 025-001	Starter 255
26.462 DF	338 kW		02/89→02/90			
26.462 DFA	338 kW		08/89→02/90			
26.462 DFAS	338 kW		08/89→02/90			
26.462 DFS	338 kW		02/89→02/90			
33.462 DF	338 kW		07/89→02/90			
33.462 DFA	338 kW		07/89→02/90			
40.462 DF	338 kW		07/89→02/90			
40.462 DFA	338 kW		07/89→02/90			
48.462 VF	338 kW		07/89→02/90			
19.502 F,19.502 FL,19.502 FLL	368 kW		02/90→06/96	☺ D2840LF01; 6kW	8EA 726 025-001	Starter 255
19.502 FS,19.502 FLS,19.502 FLLS	368 kW		02/90→06/96	☺ D2840LF04; 6kW	8EA 726 025-001	Starter 255
26.502 FNL,26.502 FNLL	368 kW		09/91→06/96	☺ D2840LF06; 6kW	8EA 726 025-001	Starter 255
33.502 DF	368 kW		09/91→06/96			
33.502 DFA	368 kW		09/91→06/96			
40.502 DFA	368 kW		02/90→06/96			
24.242 DF	177 kW		01/88→07/89	01/88→; →07/88; ☺ D2866F/240; 5.4kW	8EA 726 022-001	Starter 255
24.242 DFK	177 kW		01/88→07/89			
24.242 DFS	177 kW		01/88→07/89			
24.242 FNL,24.242 FNLL,24.242 FVL	177 kW		01/88→02/90			
26.242 DF	177 kW		01/88→07/89			
26.242 DFK	177 kW		01/88→07/89			
26.242 DFS	177 kW		01/88→07/89			
24.272 DF	198 kW		02/90→12/90	☺ D2865LF02; 5.4kW	8EA 726 022-001	Starter 255
24.272 DFK	198 kW		02/90→12/90	☺ D2865LF02; 6kW	8EA 726 025-001	Starter 255
24.272 DFS,24.272 DFLS	198 kW		02/90→04/95			
35.272 VF	198 kW		02/90→12/91			
35.272 VFK	198 kW		02/90→12/92			
41.272 VF	198 kW		02/90→12/91			
24.302 DF	220 kW		05/90→12/90	☺ D2866LF04; 5.4kW	8EA 726 022-001	Starter 255
24.302 DFK	220 kW		05/90→12/90			
24.302 FNL,24.302 FNLL,24.302 FVL	220 kW		05/90→10/90			
26.302 FNL, 26.302 FNLL, 26.302 FVL	220 kW		03/91→12/91			
26.302 FNLS,26.302 FVLS	220 kW		09/90→12/91			
32.302 VF	220 kW		05/90→09/91			
32.302 VFK	220 kW		05/90→09/91			
24.302 DFS,24.302 DFLS	220 kW		05/90→04/95	05/90→; →11/90; ☺ D2866LF04; 5.4kW	8EA 726 022-001	Starter 255
26.302 DF	220 kW		05/90→12/91			
26.302 DFA	220 kW		05/90→12/91			
26.302 DFAK	220 kW		05/90→12/91			
26.302 DFAS	220 kW		05/90→12/91			
26.302 DFK	220 kW		05/90→12/91			
35.302 VF	220 kW		05/90→09/91			
35.302 VFA	220 kW		05/90→09/91			
35.302 VFAK	220 kW		05/90→09/91			
35.302 VFK	220 kW		05/90→09/91			
24.322 DF	235 kW		02/90→12/90	☺ D2865LF03; 5.4kW	8EA 726 022-001	Starter 255
24.322 DFK	235 kW		02/90→12/90	☺ D2865LF03; 6kW	8EA 726 025-001	Starter 255
24.322 DFS,24.322 DFLS	235 kW		02/90→12/90			
24.322 FNL,24.322 FNLL,24.322 FVL	235 kW		02/90→05/95	☺ D2865LF06; 5.4kW	8EA 726 022-001	Starter 255
24.322 FNLS,24.322 FVLS	235 kW		02/90→05/95	02/90→; →11/90; ☺ D2865LF03; 5.4kW	8EA 726 022-001	Starter 255
				☺ D2865LF03; 6kW	8EA 726 025-001	Starter 255
				☺ D2865LF06; 6kW	8EA 726 025-001	Starter 255
24.372 DF	249 kW		05/90→12/90	☺ D2866LXF/SILENT; 5.4kW	8EA 726 022-001	Starter 255
24.372 DFK	249 kW		05/90→12/90			
24.372 DFS	249 kW		05/90→12/90			
24.372 FVL	249 kW		05/90→12/90			
24.372 FVLS	249 kW		05/90→12/90			
32.372 VF	249 kW		02/90→06/96			
35.372 VFK	249 kW		02/90→04/95			
24.372 DF	272 kW		02/90→12/90	☺ D2866LF03; 5.4kW	8EA 726 022-001	Starter 255
24.372 DFK	272 kW		02/90→12/90			
24.372 DFS, 24.372 DFLS	272 kW		02/90→04/95	02/90→; →10/92; ☺ D2866LF03; 5.4kW	8EA 726 022-001	Starter 255
24.372 FNL,24.372 FNLL,24.372 FVL	272 kW		02/90→05/95	02/90→; →12/94; ☺ D2866LF15; 5.4kW	8EA 726 022-001	Starter 255
				02/90→; →11/90; ☺ D2866LF03; 5.4kW	8EA 726 022-001	Starter 255
24.372 FNLS,24.372 FVLS	272 kW		02/90→05/95	☺ D2866LF03; 5.4kW	8EA 726 022-001	Starter 255
				02/90→; →10/94; ☺ D2866LF15; 5.4kW	8EA 726 022-001	Starter 255
24.422 DF	309 kW		02/90→12/90	☺ D2866LF06; 5.4kW	8EA 726 022-001	Starter 255
24.422 DFK	309 kW		02/90→12/90			
24.422 DFS,24.422 DFLS	309 kW		02/90→12/90			
32.422 VFK	309 kW		02/90→06/96			

Manufacturer - Model	Power	Displ.	Year of Constr.	Remark	Part Number	Page
MAN - F 90						07/86→12/97
24.422 FNL,24.422 FNLL,24.422 FVL	309 kW		02/90→05/95	02/90→; →12/94; ☺ D2866LF09; 5.4kW	8EA 726 022-001	Starter 255
26.422 DFK	309 kW		02/90→12/95	02/90→; →11/90; ☺ D2866LF06; 5.4kW	8EA 726 022-001	Starter 255
26.422 DFS	309 kW		02/90→12/95			
24.502 DF	368 kW		02/90→12/90	☺ D2840LF01; 6kW	8EA 726 025-001	Starter 255
24.502 DFK	368 kW		02/90→12/90			
24.502 DFS	368 kW		02/90→12/90			
24.502 FNL	368 kW		02/90→12/90			
25.302 DF	220 kW		09/90→12/91	09/90→; →11/90; ☺ D2866LF04; 5.4kW	8EA 726 022-001	Starter 255
25.302 DFK	220 kW		09/90→12/91			
25.302 DFS, 25.302 DFSL	220 kW		09/90→12/91			
25.302 FNL, 25.302 FNLL,	220 kW		09/90→12/91			
25.302 FVL	220 kW		09/90→12/91			
25.302 FNLS, 25.302 FVLS	220 kW		09/90→12/91			
25.372 DF	249 kW		09/90→12/92	09/90→; →11/90; ☺ D2866LXF/SILENT; 5.4kW	8EA 726 022-001	Starter 255
25.372 DFK	249 kW		09/90→12/92			
25.372 DFS	249 kW		09/90→12/92			
25.372 DF	272 kW		09/90→12/92	☺ D2866LF03; 5.4kW	8EA 726 022-001	Starter 255
25.372 DFK	272 kW		09/90→12/92	☺ D2866LF05; 5.4kW	8EA 726 022-001	Starter 255
25.372 DFS,25.372 DFSL	272 kW		09/90→12/92			
25.372 FNL, 25.372 FNLL,	272 kW		09/90→12/92			
25.372 FVL						
26.372 DFA	272 kW		02/90→12/92			
26.372 DFAK	272 kW		01/92→06/96			
26.372 DFAS	272 kW		02/90→12/92			
25.372 FNLS,25.372 FVLS	272 kW		09/90→10/93	09/90→; →12/92; ☺ D2866LF05; 5.4kW	8EA 726 022-001	Starter 255
				09/90→; →09/92; ☺ D2866LF03; 5.4kW	8EA 726 022-001	Starter 255
25.372 FVLS	249 kW		09/90→10/93	☺ D2866LXF/SILENT; 5.4kW	8EA 726 022-001	Starter 255
				☺ D2866LXF/SILENT; 6kW	8EA 726 025-001	Starter 255
25.422 DF	309 kW		09/90→12/92	☺ D2866LF09; 5.4kW	8EA 726 022-001	Starter 255
25.422 DFK	309 kW		09/90→12/92			
25.422 DFS,25.422 DFSL	309 kW		09/90→12/92	09/90→; →11/90; ☺ D2866LF06; 5.4kW	8EA 726 022-001	Starter 255
25.422 FNL,25.422 FNLL	309 kW		09/90→12/92			
25.422 FNLS,25.422 FVLS	309 kW		09/90→12/92			
25.502 DF	368 kW		09/90→12/92	☺ D2840LF01; 6kW	8EA 726 025-001	Starter 255
25.502 DFS	368 kW		09/90→12/92	☺ D2840LF04; 6kW	8EA 726 025-001	Starter 255
25.502 FNL	368 kW		09/90→12/92			
26.502 DFA	368 kW		02/90→12/92			
26.502 DFAS	368 kW		02/90→12/92			
26.242 DFAK	177 kW		02/89→07/89	02/89→; →03/89; ☺ D2866F/240; 5.4kW	8EA 726 022-001	Starter 255
26.272 DF	198 kW		02/90→06/96	02/90→; →10/92; ☺ D2865LF02; 6kW	8EA 726 025-001	Starter 255
				01/93→; →06/96; ☺ D2865LF05; 6kW	8EA 726 025-001	Starter 255
26.272 DFK	198 kW		02/90→06/96	01/93→; →06/96; ☺ D2865LF05; 6kW	8EA 726 025-001	Starter 255
				01/93→; →06/96; ☺ D2865LF02; 6kW	8EA 726 025-001	Starter 255
26.272 DFS,26.272 DFSL	198 kW		02/90→06/96	☺ D2865LF02; 6kW	8EA 726 025-001	Starter 255
				☺ D2865LF05; 6kW	8EA 726 025-001	Starter 255
26.272 FNL,26.272 FNLL	198 kW		03/91→05/95	03/91→; →11/92; ☺ D2865LF05; 5.4kW	8EA 726 022-001	Starter 255
				☺ D2865LF05; 6kW	8EA 726 025-001	Starter 255
26.272 FNLS,26.272 FVLS	198 kW		09/90→12/95	09/90→; →11/91; ☺ D2865LF02; 5.4kW	8EA 726 022-001	Starter 255
				09/90→; →11/92; ☺ D2865LF05; 5.4kW	8EA 726 022-001	Starter 255
				☺ D2865LF02; 6kW	8EA 726 025-001	Starter 255
				☺ D2865LF05; 6kW	8EA 726 025-001	Starter 255
26.302 DFS	220 kW		05/90→12/91	05/90→; →10/90; ☺ D2866LF04; 5.4kW	8EA 726 022-001	Starter 255
26.322 DF	235 kW		02/90→06/96	02/90→; →10/92; ☺ D2865LF03; 6kW	8EA 726 025-001	Starter 255
				01/93→; →06/96; ☺ D2865LF06; 6kW	8EA 726 025-001	Starter 255
26.322 DFA	235 kW		02/90→12/92	☺ D2865LF06; 5.4kW	8EA 726 022-001	Starter 255
26.322 DFAS	235 kW		02/90→12/92	☺ D2865LF06; 6kW	8EA 726 025-001	Starter 255
				10/92→; →12/92; ☺ D2865LF03; 6kW	8EA 726 025-001	Starter 255
26.322 DFAK	235 kW		02/90→12/92	☺ D2865LF06; 5.4kW	8EA 726 022-001	Starter 255
				☺ D2865LF03; 6kW	8EA 726 025-001	Starter 255
				☺ D2865LF06; 6kW	8EA 726 025-001	Starter 255
26.322 FNL,26.322 FNLL	235 kW		03/91→05/95	☺ D2865LF06; 5.4kW	8EA 726 022-001	Starter 255
				03/91→; →11/91; ☺ D2865LF03; 5.4kW	8EA 726 022-001	Starter 255
				☺ D2865LF03; 6kW	8EA 726 025-001	Starter 255
				☺ D2865LF06; 6kW	8EA 726 025-001	Starter 255
26.322 FNLS,26.322 FVLS	235 kW		09/90→12/95	09/90→; →03/95; ☺ D2865LF06; 5.4kW	8EA 726 022-001	Starter 255
				09/90→; →11/91; ☺ D2865LF03; 5.4kW	8EA 726 022-001	Starter 255
				☺ D2865LF03; 6kW	8EA 726 025-001	Starter 255
				☺ D2865LF06; 6kW	8EA 726 025-001	Starter 255
26.372 DF,26.372 DFL	272 kW		02/90→06/96	02/90→; →10/92; ☺ D2866LF03; 5.4kW	8EA 726 022-001	Starter 255
				10/92→; →05/94; ☺ D2866LF05; 5.4kW	8EA 726 022-001	Starter 255
				05/94→; →06/96; ☺ D2866LF15; 5.4kW	8EA 726 022-001	Starter 255

Manufacturer - Model	Power	Displ.	Year of Constr.	Remark	Part Number	Page
MAN - F 90				07/86→12/97		
26.372 DFK	272 kW		01/92→06/96	01/90→; -10/92; ⚡ D2866LF03; 5.4kW	8EA 726 022-001	Starter 255
				01/92→; -06/94; ⚡ D2866LF05; 5.4kW	8EA 726 022-001	Starter 255
				01/93→; -02/93; ⚡ D2866LF15; 5.4kW	8EA 726 022-001	Starter 255
26.372 DFS	272 kW		02/90→06/96	02/90→; -10/92; ⚡ D2866LF03; 5.4kW	8EA 726 022-001	Starter 255
				01/93→; -02/93; ⚡ D2866LF05; 5.4kW	8EA 726 022-001	Starter 255
				05/94→; -06/96; ⚡ D2866LF15; 5.4kW	8EA 726 022-001	Starter 255
26.372 FNL,26.372 FNLL,26.372 FVL	272 kW		09/90→12/95	09/90→; -11/92; ⚡ D2866LF05; 5.4kW	8EA 726 022-001	Starter 255
				09/90→; -09/92; ⚡ D2866LF03; 5.4kW	8EA 726 022-001	Starter 255
				09/90→; -12/94; ⚡ D2866LF15; 5.4kW	8EA 726 022-001	Starter 255
26.372 FNLS,26.372 FVLS	272 kW		01/92→06/96	01/90→; -10/92; ⚡ D2866LF03; 5.4kW	8EA 726 022-001	Starter 255
				05/94→; -06/96; ⚡ D2866LF15; 5.4kW	8EA 726 022-001	Starter 255
				10/92→; -11/92; ⚡ D2866LF05; 5.4kW	8EA 726 022-001	Starter 255
26.422 DF,26.422 DFL	309 kW		02/90→06/96	02/90→; -10/92; ⚡ D2866LF06; 5.4kW	8EA 726 022-001	Starter 255
				10/92→; -06/96; ⚡ D2866LF09; 5.4kW	8EA 726 022-001	Starter 255
26.422 FNL,26.422 FNLL,26.422 FVL	309 kW		09/90→12/95	09/90→; -11/92; ⚡ D2866LF09; 5.4kW	8EA 726 022-001	Starter 255
				09/90→; -11/90; ⚡ D2866LF06; 5.4kW	8EA 726 022-001	Starter 255
26.422 FNLS,26.422 FVLS	309 kW		01/92→12/95	01/92→; -09/92; ⚡ D2866LF06; 5.4kW	8EA 726 022-001	Starter 255
				01/92→; -11/92; ⚡ D2866LF09; 5.4kW	8EA 726 022-001	Starter 255
26.502 DF	368 kW		02/90→06/96	02/90→; -10/92; ⚡ D2840LF06; 6kW	8EA 726 025-001	Starter 255
				02/90→; -10/92; ⚡ D2840LF01; 6kW	8EA 726 025-001	Starter 255
				02/90→; -10/92; ⚡ D2840LF04; 6kW	8EA 726 025-001	Starter 255
26.502 DFS,26.502 DFLS	368 kW		02/90→06/96	10/92→; -06/96; ⚡ D2840LF04; 6kW	8EA 726 025-001	Starter 255
				10/92→; -06/96; ⚡ D2840LF06; 6kW	8EA 726 025-001	Starter 255
32.322 VF	235 kW		02/90→06/96	02/90→; -05/94; ⚡ D2865LF06; 6kW	8EA 726 025-001	Starter 255
32.322 VFK	235 kW		02/90→06/96	02/90→; -05/94; ⚡ D2865LF03; 6kW	8EA 726 025-001	Starter 255
35.322 VK	235 kW		02/90→06/96			
32.372 VF	272 kW		02/90→06/96	02/90→; -05/94; ⚡ D2866LF03; 5.4kW	8EA 726 022-001	Starter 255
32.372 VFK	272 kW		02/90→06/96	10/92→; -05/94; ⚡ D2866LF05; 5.4kW	8EA 726 022-001	Starter 255
35.372 VF	272 kW		02/90→06/96	05/94→; -06/96; ⚡ D2866LF15; 5.4kW	8EA 726 022-001	Starter 255
35.372 VF	272 kW		02/90→12/97			
35.372 VFK	272 kW		02/90→06/96			
35.372 VFK	272 kW		02/90→12/97			
32.422 VF	309 kW		02/90→06/96	02/90→; -05/94; ⚡ D2866LF06; 5.4kW	8EA 726 022-001	Starter 255
35.422 VFK	309 kW		02/90→06/96	10/92→; -06/96; ⚡ D2866LF09; 5.4kW	8EA 726 022-001	Starter 255
35.422 VFK	309 kW		02/90→12/97			
33.272 DF	198 kW		10/92→04/95	⚡ D2865LF05; 5.4kW	8EA 726 022-001	Starter 255
33.272 DFA	198 kW		10/92→04/95	⚡ D2865LF05; 6kW	8EA 726 025-001	Starter 255
33.272 FVL	191 - 198 kW		10/92→04/95			
33.372 DF	272 kW		09/91→06/96	10/92→; -05/94; ⚡ D2866LF05; 5.4kW	8EA 726 022-001	Starter 255
33.372 DFA	272 kW		09/91→06/96	05/94→; -06/96; ⚡ D2866LF15; 5.4kW	8EA 726 022-001	Starter 255
33.372 DFS	272 kW		09/91→06/96	09/91→; -10/92; ⚡ D2866LF03; 5.4kW	8EA 726 022-001	Starter 255
33.372 DFAK	272 kW		01/91→06/96	10/92→; -05/94; ⚡ D2866LF05; 5.4kW	8EA 726 022-001	Starter 255
33.372 DFK	272 kW		01/91→06/96	05/94→; -06/96; ⚡ D2866LF15; 5.4kW	8EA 726 022-001	Starter 255
				01/91→; -10/92; ⚡ D2866LF03; 5.4kW	8EA 726 022-001	Starter 255
35.292 VF	213 kW		10/88→04/95	⚡ D2866LFZ/290; 5.4kW	8EA 726 022-001	Starter 255
35.292 VFK	213 kW		10/88→04/95			
35.322 VFK	235 kW		02/90→06/96	⚡ D2865LF06; 6kW	8EA 726 025-001	Starter 255
				⚡ D2865LF03; 6kW	8EA 726 025-001	Starter 255
				10/92→; -06/96; ⚡ D2865LF03; 6kW	8EA 726 025-001	Starter 255
				10/92→; -06/96; ⚡ D2865LF06; 6kW	8EA 726 025-001	Starter 255
35.332 VF	243 kW		10/88→04/95	⚡ D2866LFZ/330; 5.4kW	8EA 726 022-001	Starter 255
35.332 VFK	243 kW		10/88→04/95			
35.372 VF	249 kW		02/90→04/95	02/90→; -11/90; ⚡ D2866LXF/SILENT; 5.4kW	8EA 726 022-001	Starter 255
35.402 VF	294 kW		05/94→12/97	05/94→; -06/96; ⚡ D2866LF16; 5.4kW	8EA 726 022-001	Starter 255
35.402 VFK	294 kW		05/94→12/97			
35.422 VF	309 kW		02/90→06/96	02/90→; -05/94; ⚡ D2866LF06; 5.4kW	8EA 726 022-001	Starter 255
35.422 VF	309 kW		02/90→12/97	10/90→; -06/96; ⚡ D2866LF09; 5.4kW	8EA 726 022-001	Starter 255
41.322 VF	235 kW		02/90→06/96	⚡ D2865LF06; 6kW	8EA 726 025-001	Starter 255
				02/90→; -05/94; ⚡ D2865LF03; 6kW	8EA 726 025-001	Starter 255
41.372 VF	272 kW		02/90→06/96	02/90→; -05/94; ⚡ D2866LF03; 5.4kW	8EA 726 022-001	Starter 255
				05/94→; -06/96; ⚡ D2866LF15; 5.4kW	8EA 726 022-001	Starter 255
				10/92→; -11/92; ⚡ D2866LF05; 5.4kW	8EA 726 022-001	Starter 255
41.402 VF	294 kW		05/94→06/96	05/94→; -05/94; ⚡ D2866LF16; 5.4kW	8EA 726 022-001	Starter 255
41.422 VF	309 kW		02/90→06/96	02/90→; -05/94; ⚡ D2866LF09; 5.4kW	8EA 726 022-001	Starter 255
				02/90→; -05/94; ⚡ D2866LF06; 5.4kW	8EA 726 022-001	Starter 255
MAN - F 2000				01/94→		
19.233 FCNG	170 kW			09/96→; -12/01; ⚡ E2866DF01; 5.4kW	8EA 726 022-001	Starter 255
19.233 FKNG	170 kW			03/00→; ⚡ E2866DF01; 5.4kW	8EA 726 022-001	Starter 255

Manufacturer - Model	Power	Displ.	Year of Constr.	Remark	Part Number	Page
MAN - F 2000						01/94→
19.273 F, FL, FLL	198 kW		01/94→	01/94→; →12/95; ⚙️ D2865LF22; 5.4kW	8EA 726 022-001	Starter 255
19.273 FA	198 kW		01/94→			
19.273 FAK	198 kW		01/94→			
19.273 FK	198 kW		01/94→			
19.273 FS, 19.273 FLS	198 kW		01/94→12/95	⚙️ D2865LF22; 5.4kW	8EA 726 022-001	Starter 255
24.273 FNLLC	198 kW		01/94→12/95			
26.273 DFC, 26.273 DFLC	198 kW		01/94→12/95			
26.273 DFK, 26.273 DFLK	198 kW		01/94→12/95			
26.273 DFS, 26.273 DFSL	198 kW		01/94→12/95			
26.273 FNLC, 26.273 FNLLC,	198 kW		01/94→12/95			
26.273 FVLC						
26.273 FNLS, 26.273 FVLS	198 kW		01/94→12/95			
27.273 DFAC	198 kW		01/94→12/95			
27.273 DFAK	198 kW		01/94→12/95			
27.273 DFAS	198 kW		01/94→12/95			
27.273 DFC	198 kW		01/94→12/95			
27.273 DFK	198 kW		01/94→12/95			
27.273 DFS	198 kW		01/94→12/95			
19.293 FAC	213 kW		01/94→	01/94→; →09/01; ⚙️ D2865LF20; 5.4kW	8EA 726 022-001	Starter 255
19.293 FAK	213 kW		01/94→			
19.293 FAS	213 kW		01/94→	04/95→; →09/01; ⚙️ D2865LF24; 5.4kW	8EA 726 022-001	Starter 255
19.293 FC, 19.293 FLC, 19.293 FLLC	213 kW		01/94→	01/94→; →09/01; ⚙️ D2865LF20; 6kW	8EA 726 025-001	Starter 255
19.293 FK, 19.293 FLK	213 kW		01/94→			
19.293 FS, 19.293 FLS, 19.293 FLLS	213 kW		01/94→			
26.293 DFK, 26.293 DFLK	213 kW		01/94→			
26.293 FNLC, 26.293 FNLLC,	213 kW		01/94→			
26.293 FVLC						
26.293 FNLS, 26.293 FVLS	213 kW		01/94→			
27.293 DFAC	213 kW		01/94→			
27.293 DFAK	213 kW		01/94→			
27.293 DFAS	213 kW		01/94→			
27.293 DFC	213 kW		01/94→			
27.293 DFK	213 kW		01/94→			
27.293 DFS	213 kW		01/94→			
19.314 FAS	228 kW		06/98→	06/98→; →12/01; ⚙️ D2866LF34; 5.4kW	8EA 726 022-001	Starter 255
19.314 FC, FLC, FLLC, FLLW, FRC, FLRC, FLLRC, FLL, FLLR, F-N	228 kW		06/98→			
19.314 FK, FLK, F-KI, FL-KI	228 kW		06/98→			
19.314 FS, FLS, FLLS, FRS, FLRS, FLLRS	228 kW		06/98→			
19.323 FAC	235 kW		01/94→12/95	⚙️ D2865LF23; 5.4kW	8EA 726 022-001	Starter 255
19.323 FAK	235 kW		01/94→12/95			
19.323 FAS	235 kW		01/94→12/95			
19.323 FC, 19.323 FLC, 19.323 FLLC	235 kW		01/94→12/95			
19.323 FK, 19.323 FLK	235 kW		01/94→12/95			
19.323 FS, 19.323 FLS, 19.323 FLLS	235 kW		01/94→12/95			
24.323 FNLLC	235 kW		01/94→12/95			
26.323 DFC, 26.323 DFLC	235 kW		01/94→12/95			
26.323 DFK, 26.323 DFLK	235 kW		01/94→12/95			
26.323 DFS, 26.323 DFSL	235 kW		01/94→12/95			
26.323 FNLC, 26.323 FNLLC,	235 kW		01/94→12/95			
26.323 FVLC						
26.323 FNLS, 26.323 FVLS	235 kW		01/94→12/95			
27.323 DFAC	235 kW		01/94→12/95			
27.323 DFAS	235 kW		01/94→12/95			
27.323 DFC	235 kW		01/94→12/95			
27.323 DFS	235 kW		01/94→12/95			
33.323 DFAC	235 kW		01/94→12/95			
33.323 DFAK	235 kW		01/94→12/95			
33.323 DFAS	235 kW		01/94→12/95			
33.323 DFC	235 kW		01/94→12/95			
33.323 DFK	235 kW		01/94→12/95			
33.323 DFS	235 kW		01/94→12/95			
19.343 FAC	250 kW		01/94→	01/94→; →09/01; ⚙️ D2865LF21; 5.4kW	8EA 726 022-001	Starter 255
19.343 FAK	250 kW		01/94→			
19.343 FAS	250 kW		01/94→			
19.343 FC, 19.343 FLC, 19.343 FLLC	250 kW		01/94→			
19.343 FK, 19.343 FLK	250 kW		01/94→			
19.343 FS, 19.343 FLS, 19.343 FLLS	250 kW		01/94→			
26.343 DFC, 26.343 DFLC	250 kW		01/94→			
26.343 DFK, 26.343 DFLK	250 kW		01/94→			
26.343 DFS, 26.343 DFSL	250 kW		01/94→			

Manufacturer - Model	Power	Displ.	Year of Constr.	Remark	Part Number	Page
MAN - F 2000						01/94→
26.343 FNLS,26.343 FVLS	250 kW		01/94→	01/94→; →09/01; ☺ D2866LF21; 5.4kW	8EA 726 022-001	Starter 255
33.343 DFAC	250 kW		01/94→			
33.343 DFAK	250 kW		01/94→			
33.343 DFAS	250 kW		01/94→			
33.343 DFC	250 kW		01/94→			
33.343 DFK	250 kW		01/94→			
33.343 DFS	250 kW		01/94→			
19.364 FAC	265 kW		06/98→	06/98→; →12/01; ☺ D2866LF35; 5.4kW	8EA 726 022-001	Starter 255
19.364 FAK, FA-KI	265 kW		06/98→			
19.364 FAS	265 kW		06/98→			
19.364 FC, FLC, FLLC, FLLW, FRC, FLRC, FLLRC, FLL, FLLR, F-N	265 kW		06/98→			
19.364 FK, FLK, F-KI, FL-KI	265 kW		06/98→			
19.364 FS, FLS, FLLS, FRS, FLRS, FLLRS	265 kW		06/98→			
19.373 FAC	272 kW		01/94→			
19.373 FAK, FA-KI	272 kW		01/94→			
19.373 FAS	272 kW		01/94→			
19.373 FC, FLC, FLLC, FRC, FLRC, F-NL	272 kW		01/94→			
19.373 FK, FLK, F-KI, FL-KI	272 kW		01/94→			
19.373 FS, FLS, FLLS, FRS, FLRS, FLLRS	272 kW		01/94→			
27.373 DFAC	272 kW		01/94→			
27.373 DFAK, DFA-KI	272 kW		01/94→			
27.373 DFAS	272 kW		01/94→			
27.373 DFC	272 kW		01/94→			
27.373 DFK, DF-KI	272 kW		01/94→			
27.373 DFS	272 kW		01/94→			
33.373 DFAC	272 kW		01/94→			
33.373 DFAK, DFA-KI	272 kW		01/94→			
33.373 DFC	272 kW		01/94→			
33.373 DFK, DF-KI	272 kW		01/94→			
33.373 DFS, DFRS	272 kW		01/94→			
19.403 FAC	294 kW		01/94→	01/94→; →09/01; ☺ D2866LF20; 5.4kW	8EA 726 022-001	Starter 255
19.403 FAK, FA-KI	294 kW		01/94→			
19.403 FAS	294 kW		01/94→			
19.403 FC, FLC, FLLC, FRC, FLRC, F-NL	294 kW		01/94→			
19.403 FK, FLK, F-KI, FL-KI	294 kW		01/94→			
19.403 FS, FLS, FLLS, FRS, FLRS, FLLRS	294 kW		01/94→			
24.403 FNLLC	294 kW		01/94→			
26.403 DFC,26.403 DFLC	294 kW		01/94→			
26.403 DFK,26.403 DFLK	294 kW		01/94→			
26.403 DFS,26.403 DFSL	294 kW		01/94→			
26.403 FNLC,26.403 FNLLC, 26.403 FVLC	294 kW		01/94→			
26.403 FNLS,26.403 FVLS	294 kW		01/94→			
33.403 DFAC	294 kW		01/94→			
33.403 DFAK, DFA-KI	294 kW		01/94→			
33.403 DFAS	294 kW		01/94→			
33.403 DFC	294 kW		01/94→			
33.403 DFK, DF-KI	294 kW		01/94→			
33.403 DFS, DFRS	294 kW		01/94→			
19.414 FAC	301 kW		06/98→	06/98→; →12/01; ☺ D2866LF31; 5.4kW	8EA 726 022-001	Starter 255
19.414 FAK, FA-KI	301 kW		06/98→			
19.414 FAS	301 kW		06/98→			
19.414 FC, FLC, FLLC, FRC, FLRC, FLLRC, FLL, FLLR, F-NL	301 kW		06/98→			
19.414 FK, FLK, F-KI, FL-KI	301 kW		06/98→			
19.414 FS, FLS, FLLS, FRS, FLRS, FLLRS	301 kW		06/98→			
19.423 FAC	309 kW		01/94→12/95			
19.423 FAS	309 kW		01/94→12/95			
24.423 FNLLC	309 kW		01/94→12/95			
26.423 DFC,26.423 DFLC	309 kW		01/94→12/95			
26.423 DFK,26.423 DFLK	309 kW		01/94→12/95			
26.423 DFS,26.423 DFSL	309 kW		01/94→12/95			
26.423 FNLC,26.423 FNLLC, 26.423 FVLC	309 kW		01/94→12/95			
26.423 FNLS,26.423 FVLS	309 kW		01/94→12/95			
27.423 DFAK, DFA-KI	309 kW		01/94→			
27.423 DFAS	309 kW		01/94→12/95			
19.423 FAK, FA-KI	309 kW		01/94→	01/94→; →12/95; ☺ D2866LF22; 5.4kW	8EA 726 022-001	Starter 255
19.423 FC, FLC, FLLC, F-NL	309 kW		01/94→			
19.423 FK, FLK, F-KI, FL-KI	309 kW		01/94→			
19.423 FS, FLS, FLLS	309 kW		01/94→			

Manufacturer - Model	Power	Displ.	Year of Constr.	Remark	Part Number	Page			
MAN - F 2000						01/94→			
27.423 DFAC	309 kW		01/94→	01/94→; →12/95; ☺ D2866LF22; 5.4kW	8EA 726 022-001	Starter 255			
27.423 DFC	309 kW		01/94→						
27.423 DFK, DF-KI	309 kW		01/94→						
27.423 DFS	309 kW		01/94→						
33.423 DFAC	309 kW		01/94→						
33.423 DFAK, DFA-KI	309 kW		01/94→						
33.423 DFAS	309 kW		01/94→						
33.423 DFC	309 kW		01/94→						
33.423 DFK, DF-KI	309 kW		01/94→						
33.423 DFS, DFRS	309 kW		01/94→						
19.463 FAC	338 kW		01/94→				01/94→; →09/01; ☺ D2876LF02; 5.4kW	8EA 726 022-001	Starter 255
19.463 FAK, FA-KI	338 kW		01/94→						
19.463 FAS	338 kW		01/94→						
19.463 FC, FLC, FLLC, FRC, FLRC, F-NL	338 kW		01/94→						
19.463 FK, FLK, F-KI, FL-KI	338 kW		01/94→						
19.463 FS, FLS, FLLS, FRS, FLRS, FLLRS	338 kW		01/94→						
23.463 FNLLC	338 kW		01/94→						
24.463 FNLLC	338 kW		01/94→						
26.463 DFC, DFCL	338 kW		01/94→						
26.463 DFK,26.463 DFLK	338 kW		01/94→						
26.463 DFS,26.463 DFSL	338 kW		01/94→						
26.463 FNLC, FNLLC, FVLC	338 kW		01/94→						
26.463 FNLS,26.463 FVLS	338 kW		01/94→						
33.463 DFAC	338 kW		01/94→						
33.463 DFAK, DFA-KI	338 kW		01/94→						
33.463 DFAS	338 kW		01/94→						
33.463 DFC	338 kW		01/94→						
33.463 DFK, DF-KI	338 kW		01/94→						
33.463 DFS, DFRS	338 kW		01/94→						
19.464 FAK, FA-KI	338 kW		06/98→	06/98→; →07/01; ☺ D2876LF06; 5.4kW	8EA 726 022-001	Starter 255			
19.464 FAS	338 kW		06/98→						
19.464 FC, FLC, FLLC, FLL, FRC, FLLR, FLLRC, FLLW, F-NL	338 kW		06/98→						
19.464 FK, FLK, F-KI, FL-KI	338 kW		06/98→						
19.464 FS, FLS, FLLS, FRS, FLRS, FLLRS	338 kW		06/98→						
19.603 FLS, 19604 FLS	441 kW		04/96→						
23.293 FNLLC	213 kW		01/94→	04/96→; →09/01; ☺ D2840LF20; 6kW	8EA 726 025-001	Starter 255			
				04/95→; →01/00; ☺ D2865LF24; 5.4kW					
				01/94→; →01/00; ☺ D2865LF20; 5.4kW					
				01/94→; →01/00; ☺ D2865LF20; 6kW					
23.343 FNLLC	250 kW		01/94→	01/94→; →01/00; ☺ D2865LF21; 5.4kW	8EA 726 022-001	Starter 255			
24.343 FNLLC	250 kW		01/94→						
23.403 FNLLC	294 kW		01/94→	01/94→; →09/00; ☺ D2866LF20; 5.4kW	8EA 726 022-001	Starter 255			
24.293 FNLLC	213 kW		01/94→						
24.373 FNLLC	272 kW		01/94→12/95	☺ D2866LF21; 5.4kW	8EA 726 022-001	Starter 255			
26.373 DFC,26.373 DFCL	272 kW		01/94→12/95						
26.373 DFK,26.373 DFLK	272 kW		01/94→12/95						
26.373 DFS,26.373 DFSL	272 kW		01/94→12/95						
26.373 FNLC,26.373 FNLLC, 26.373 FVLC	272 kW		01/94→12/95						
26.373 FNLS,26.373 FVLS	272 kW		01/94→12/95						
33.373 DFAS	272 kW		01/94→						
26.233 FVL CNG	170 kW		09/96→				09/96→; →08/02; ☺ E2866DF01; 5.4kW	8EA 726 022-001	Starter 255
26.233 FVL-KO	170 kW		03/00→	5.4kW	8EA 726 022-001	Starter 255			
27.314 DFS	228 kW		05/01→						
27.364 DFAK, DFA-KI	265 kW		05/01→						
27.364 DFAS	265 kW		05/01→						
27.414 DFAK, DFA-KI	301 kW		05/01→						
27.414 DFAS	301 kW		05/01→						
27.414 DFS	301 kW		05/01→						
27.464 DFAK, DFA-KI	338 kW		05/01→						
27.464 DFAS	338 kW		05/01→						
33.364 DFAC	265 kW		05/01→						
33.364 DFAK, DFA-KI	265 kW		05/01→						
33.364 DFAS	265 kW		05/01→						
33.364 DFS, DFRS	265 kW		05/01→						
33.414 DFAS	301 kW		05/01→						
33.414 DFS, DFRS	301 kW		05/01→						
33.464 DFAC	338 kW		05/01→						
33.464 DFAK, DFA-KI	338 kW		05/01→						
33.464 DFAS	338 kW		05/01→						
35.314 VF-TM	228 kW		03/02→						
26.293 DFC,26.293 DFCL	213 kW		01/94→				01/94→; →09/01; ☺ D2865LF20; 5.4kW	8EA 726 022-001	Starter 255
26.293 DFS,26.293 DFSL	213 kW		01/94→						

Manufacturer - Model	Power	Displ.	Year of Constr.	Remark	Part Number	Page
MAN - F 2000						01/94→
26.314 DFS, DFLS	228 kW		05/01→	☺ D2866LF23; 5.4kW	8EA 726 022-001	Starter 255
26.314 FNLS	228 kW		05/01→			
26.314 FVLS, FVLRS	228 kW		05/01→			
27.314 FVL	228 kW		06/98→			
26.343 FNLC, 26.343 FNLLC,	250 kW		01/94→	☺ D2865LF21; 5.4kW	8EA 726 022-001	Starter 255
26.343 FVLC						
27.343 DFAK	250 kW		01/94→			
26.364 FNLS	265 kW		05/01→	☺ D2866LF24; 5.4kW	8EA 726 022-001	Starter 255
26.364 FVLS, FVLRS	265 kW		05/01→			
27.364 DFAC	265 kW		05/01→			
27.364 FVL	265 kW		06/98→			
26.464 FNLS	338 kW		05/01→	☺ D2876LF03; 5.4kW	8EA 726 022-001	Starter 255
26.464 FVLS, FVLRS	338 kW		05/01→			
27.464 DFAC	338 kW		05/01→			
26.603 DFC, DFCL	441 kW		06/96→	☺ D2840LF20; 6kW	8EA 726 025-001	Starter 255
26.603 DFK, DFLK	441 kW		06/96→			
26.603 DFS, DFLS	441 kW		06/96→			
27.323 DFAK, DFA-KI	235 kW		01/94→	01/94→; →12/95; ☺ D2865LF23; 5.4kW	8EA 726 022-001	Starter 255
27.323 DFK, DF-KI	235 kW		01/94→			
27.343 DFAC	250 kW		01/94→	01/94→; →09/01; ☺ D2865LF21; 5.4kW	8EA 726 022-001	Starter 255
27.343 DFAS	250 kW		01/94→	01/94→; →09/01; ☺ D2865LF21; 6kW	8EA 726 025-001	Starter 255
27.343 DFC	250 kW		01/94→			
27.343 DFK	250 kW		01/94→			
27.343 DFS	250 kW		01/94→			
27.403 DFAC	294 kW		01/94→	01/94→; →09/01; ☺ D2866LF20; 5.4kW	8EA 726 022-001	Starter 255
27.403 DFAK, DFA-KI	294 kW		01/94→	01/94→; →09/01; ☺ D2866LF20; 6kW	8EA 726 025-001	Starter 255
27.403 DFC	294 kW		01/94→			
27.403 DFK, DF-KI	294 kW		01/94→			
27.403 DFS	294 kW		01/94→			
27.403 DFAS	294 kW		01/94→	☺ D2866LF20; 5.4kW	8EA 726 022-001	Starter 255
40.403 DFAS	294 kW		01/94→			
27.414 FVL	301 kW		06/98→	☺ D2866LF25; 5.4kW	8EA 726 022-001	Starter 255
27.463 DFAC	338 kW		01/94→	01/94→; →09/01; ☺ D2876LF02; 5.4kW	8EA 726 022-001	Starter 255
27.463 DFAK, DFA-KI	338 kW		01/94→	01/94→; →09/01; ☺ D2876LF02; 6kW	8EA 726 025-001	Starter 255
27.463 DFAS	338 kW		01/94→			
27.463 DFC	338 kW		01/94→			
27.463 DFK, DF-KI	338 kW		01/94→			
27.463 DFS	338 kW		01/94→			
27.603 DFAS	441 kW		01/96→	01/96→; →09/01; ☺ D2840LF20; 6kW	8EA 726 025-001	Starter 255
27.603 DFS	441 kW		01/96→			
32.293 VFC	213 kW		08/95→	08/95→; →09/01; ☺ D2865LF24; 5.4kW	8EA 726 022-001	Starter 255
32.343 VFC	250 kW		08/95→	08/95→; →09/01; ☺ D2865LF21; 5.4kW	8EA 726 022-001	Starter 255
32.343 VFK	250 kW		08/95→			
35.343 VFC	250 kW		08/95→			
35.343 VFK	250 kW		08/95→			
41.343 VFC	250 kW		08/95→			
41.343 VFK	250 kW		08/95→			
32.403 VFC	294 kW		08/95→	08/95→; →09/01; ☺ D2866LF20; 5.4kW	8EA 726 022-001	Starter 255
32.403 VFK	294 kW		08/95→			
35.403 VF, VFC, VFRC	294 kW		08/95→			
41.403 VF, VFC, VFRC	294 kW		08/95→			
41.403 VFK, VF-HK, VF-KI	294 kW		08/95→			
32.463 VFC	338 kW		08/95→	08/95→; →09/01; ☺ D2876LF02; 5.4kW	8EA 726 022-001	Starter 255
32.463 VFK	338 kW		08/95→			
35.463 VF, VFC, VFRC	338 kW		08/95→			
35.463 VFK, VF-HK, VF-KI	338 kW		08/95→			
41.463 VF, VFC, VFRC	338 kW		08/95→			
41.463 VFK, VF-HK, VF-KI	338 kW		08/95→			
33.603 DFAC	441 kW		06/96→	06/96→; →09/01; ☺ D2840LF20; 6kW	8EA 726 025-001	Starter 255
33.603 DFAS	441 kW		06/96→			
33.603 DFC	441 kW		06/96→			
33.603 DFS	441 kW		06/96→			
40.463 DFAS	338 kW		01/94→	☺ D2876LF02; 5.4kW	8EA 726 022-001	Starter 255
MAN - G 90						09/87→05/95
10.150 F, 10.150 FL	92 kW		05/90→10/93	☺ D0226MF/SILENT; 4kW	8EA 726 038-001	Starter 256
9.150 F, 9.150 FL	92 kW		05/90→10/93	☺ D0226MF/SILENT; 4kW	8EA 726 219-001	Starter 256
10.150 F, 10.150 FL	110 - 114 kW		09/87→10/93	☺ D0826GF03; 4kW	8EA 726 038-001	Starter 256
8.150 FOC	110 - 114 kW		07/88→10/93	☺ D0826GF01; 4kW	8EA 726 038-001	Starter 256
9.150 FOC	110 - 114 kW		07/88→10/93	☺ D0826GF03; 4kW	8EA 726 219-001	Starter 256
				☺ D0826GF01; 4kW	8EA 726 219-001	Starter 256
				☺ D0826GF03; 4kW	8EA 737 912-001	Starter 257
				☺ D0826GF01; 4kW	8EA 737 912-001	Starter 257
				☺ D0826GF03; 4kW	8EA 738 029-001	Starter 257

Manufacturer - Model	Power	Displ.	Year of Constr.	Remark	Part Number	Page
MAN - G 90					09/87→05/95	
10.150 F,10.150 FL	110 - 114 kW		09/87→10/93	☺ D0826GF01; 4kW	8EA 738 029-001	Starter 257
8.150 FOC	110 - 114 kW		07/88→10/93			
9.150 FOC	110 - 114 kW		07/88→10/93			
10.150 FK	110 - 114 kW		09/87→10/93	☺ D0826GF01; 4kW	8EA 726 038-001	Starter 256
				☺ D0826GF03; 4kW	8EA 726 038-001	Starter 256
				☺ D0826GF03; 4kW	8EA 726 219-001	Starter 256
				☺ D0826GF01; 4kW	8EA 726 219-001	Starter 256
6.100 F	75 kW		09/87→10/93	☺ D0824GF01; 4kW	8EA 726 038-001	Starter 256
6.100 FK	75 kW		09/87→10/93	☺ D0824GF02; 4kW	8EA 726 038-001	Starter 256
8.100 F	75 kW		09/87→10/93	☺ D0824GF; 4kW	8EA 726 038-001	Starter 256
8.100 FK	75 kW		09/87→10/93	☺ D0824GF02; 4kW	8EA 726 219-001	Starter 256
				☺ D0824GF; 4kW	8EA 726 219-001	Starter 256
				☺ D0824GF01; 4kW	8EA 726 219-001	Starter 256
8.150 F,8.150 FL	92 kW		05/90→10/93	☺ D0226MF; 4kW	8EA 726 038-001	Starter 256
				☺ D0226MF; 4kW	8EA 726 219-001	Starter 256
8.150 F,8.150 FL	110 - 114 kW		09/87→10/93	☺ D0826GF; 4kW	8EA 726 038-001	Starter 256
8.150 FAE	110 - 114 kW		05/88→05/95	☺ D0826GF03; 4kW	8EA 726 038-001	Starter 256
8.150 FS,8.150 FLS	110 - 114 kW		09/87→10/93	☺ D0826GF03; 4kW	8EA 726 219-001	Starter 256
9.150 FS,9.150 FLS	110 - 114 kW		09/87→10/93	☺ D0826GF; 4kW	8EA 726 219-001	Starter 256
				☺ D0826GF03; 4kW	8EA 737 912-001	Starter 257
				☺ D0826GF; 4kW	8EA 737 912-001	Starter 257
				☺ D0826GF03; 4kW	8EA 738 029-001	Starter 257
				☺ D0826GF; 4kW	8EA 738 029-001	Starter 257
8.150 FAKO	110 kW		10/92→05/95	☺ D0826GF03; 4kW	8EA 726 038-001	Starter 256
9.150 FAKO	110 kW		10/92→05/95	☺ D0826GF03; 4kW	8EA 726 219-001	Starter 256
				☺ D0826GF03; 4kW	8EA 737 912-001	Starter 257
				☺ D0826GF03; 4kW	8EA 738 029-001	Starter 257
8.150 FK	110 - 114 kW		09/87→10/93	☺ D0826GF03; 4kW	8EA 726 038-001	Starter 256
				☺ D0826GF; 4kW	8EA 726 038-001	Starter 256
				☺ D0826GF; 4kW	8EA 726 219-001	Starter 256
				☺ D0826GF03; 4kW	8EA 726 219-001	Starter 256
8.170 FOC	125 - 131 kW		02/89→10/93	☺ D0226MCF01/170; 4kW	8EA 726 038-001	Starter 256
9.170 FOC	125 - 131 kW		02/89→10/93	☺ D0226MCF01/170; 4kW	8EA 726 219-001	Starter 256
9.150 F,9.150 FL	110 - 114 kW		09/87→10/93	☺ D0826GF; 4kW	8EA 726 038-001	Starter 256
9.150 FK	110 - 114 kW		09/87→10/93	☺ D0826GF03; 4kW	8EA 726 038-001	Starter 256
				☺ D0826GF; 4kW	8EA 726 219-001	Starter 256
				☺ D0826GF03; 4kW	8EA 726 219-001	Starter 256
				05/88-; →10/93; ☺ D0826GF; 4kW	8EA 737 912-001	Starter 257
				05/88-; →10/93; ☺ D0826GF03; 4kW	8EA 737 912-001	Starter 257
				05/88-; →10/93; ☺ D0826GF03; 4kW	8EA 738 029-001	Starter 257
				05/88-; →10/93; ☺ D0826GF; 4kW	8EA 738 029-001	Starter 257
9.150 FAE	110 - 114 kW		05/88→05/92	☺ D0826GF03; 4kW	8EA 726 038-001	Starter 256
				☺ D0826GF; 4kW	8EA 726 038-001	Starter 256
				☺ D0826GF03; 4kW	8EA 726 219-001	Starter 256
				☺ D0826GF; 4kW	8EA 726 219-001	Starter 256
				☺ D0826GF; 4kW	8EA 737 912-001	Starter 257
				☺ D0826GF; 4kW	8EA 738 029-001	Starter 257
MAN - G					10/79→08/88	
10.136 F,10.136 FL	100 kW		09/81→09/87	☺ D0226MF; 4kW	8EA 726 038-001	Starter 256
8.136 F,8.136 FL	100 kW		10/79→09/87	07/83-; →09/87; ☺ D0226MF; 4kW	8EA 726 219-001	Starter 256
9.136 F,9.136 FL	100 kW		10/79→09/87	☺ D0226MF; 4kW	8EA 726 219-001	Starter 256
10.136 FK	100 kW		09/81→09/87	☺ D0226MF; 4kW	8EA 726 038-001	Starter 256
				07/83-; →09/87; ☺ D0226MF; 4kW	8EA 726 219-001	Starter 256
6.90 F	66 - 66 kW		10/79→09/87	☺ D0224MF; 4kW	8EA 726 038-001	Starter 256
6.90 FK	66 kW		10/79→09/87	07/83-; →09/87; ☺ D0224MF; 4kW	8EA 726 219-001	Starter 256
8.90 F	66 kW		10/79→09/87			
8.90 FK	66 kW		10/79→09/87			
8.136 FAE	100 kW		12/83→08/88	☺ D0226MF; 4kW	8EA 726 038-001	Starter 256
9.136 FAE	100 kW		12/83→08/88	☺ D0226MF; 4kW	8EA 726 219-001	Starter 256
8.136 FK	100 kW		10/79→08/88	☺ D0226MF; 4kW	8EA 726 038-001	Starter 256
9.136 FK	100 kW		10/79→08/88	07/83-; →08/88; ☺ D0226MF; 4kW	8EA 726 219-001	Starter 256
8.136 FOC	100 kW		03/82→07/88	☺ D0226MF; 4kW	8EA 726 038-001	Starter 256
9.136 FOC	100 kW		03/82→07/88	07/83-; →07/88; ☺ D0226MF; 4kW	8EA 726 219-001	Starter 256

Manufacturer - Model	Power	Displ.	Year of Constr.	Remark	Part Number	Page
MAN - L 2000						10/93→
10.145 LC,10.145 LLC, LRC, LLRC (LE140C)	103 kW		09/00→	☺ D0834FL02; 4kW	8EA 737 912-001	Starter 257
9.145 LC,9.145 LLC, LRC, LLRC (LE140C)	103 kW		09/00→	☺ D0834FL02; 4kW	8EA 738 029-001	Starter 257
10.145 LK, LRK, L-KI, LR-KI (LE140C)	103 kW		09/00→	07/01→; ☺ D0834FL02; 4kW	8EA 737 912-001	Starter 257
10.145 LLS, LLRS (LE140C)	103 kW		09/00→	07/01→; ☺ D0834FL02; 4kW	8EA 738 029-001	Starter 257
8.145 LLS, LLRS (LE140C)	103 kW		09/00→			
8.145 LRK, L-KI, LR-KILK (LE140C)	103 kW		09/00→			
9.145 LK, LRK, L-KI, LR-KI (LE140C)	103 kW		09/00→			
9.145 LLS, LLRS (LE140C)	103 kW		09/00→			
10.150 FOC	114 - 118 kW		02/95→01/96	☺ D0824LFO; 4kW	8EA 726 038-001	Starter 256
				☺ D0824LFO; 4kW	8EA 726 219-001	Starter 256
				☺ D0824LFO; 4kW	8EA 737 912-001	Starter 257
				☺ D0824LFO; 4kW	8EA 738 029-001	Starter 257
10.153 F	114 kW		10/93→	☺ D0824LFL01; 4kW	8EA 726 038-001	Starter 256
				☺ D0824LFL05; 4kW	8EA 726 038-001	Starter 256
				☺ D0824LFL05; 4kW	8EA 737 912-001	Starter 257
				☺ D0824LFL01; 4kW	8EA 737 912-001	Starter 257
				☺ D0824LFL01; 4kW	8EA 738 029-001	Starter 257
				☺ D0824LFL05; 4kW	8EA 738 029-001	Starter 257
10.153 FA	114 kW		10/93→	☺ D0824LFL01; 4kW	8EA 726 038-001	Starter 256
				☺ D0824LFL05; 4kW	8EA 726 038-001	Starter 256
				☺ D0824LFL01; 4kW	8EA 726 219-001	Starter 256
				☺ D0824LFL05; 4kW	8EA 726 219-001	Starter 256
				☺ D0824LFL01; 4kW	8EA 737 912-001	Starter 257
				☺ D0824LFL05; 4kW	8EA 737 912-001	Starter 257
				☺ D0824LFL05; 4kW	8EA 738 029-001	Starter 257
				☺ D0824LFL01; 4kW	8EA 738 029-001	Starter 257
10.153 LAEK	114 kW		10/93→06/96	01/95→; -06/96; ☺ D0824LFL01; 4kW	8EA 737 912-001	Starter 257
8.153 LLS	114 kW		10/93→06/96	01/95→; -06/96; ☺ D0824LFL05; 4kW	8EA 737 912-001	Starter 257
				01/95→; -06/96; ☺ D0824LFL01; 4kW	8EA 738 029-001	Starter 257
				01/95→; -06/96; ☺ D0824LFL05; 4kW	8EA 738 029-001	Starter 257
10.153 LC,10.153 LLC	114 kW		10/93→06/96	☺ D0824LFL05; 4kW	8EA 737 912-001	Starter 257
10.153 LK	114 kW		10/93→06/96	☺ D0824LFL01; 4kW	8EA 737 912-001	Starter 257
10.153 LLS	114 kW		10/93→06/96	☺ D0824LFL01; 4kW	8EA 738 029-001	Starter 257
8.153 LAEC	114 kW		01/95→06/96	☺ D0824LFL05; 4kW	8EA 738 029-001	Starter 257
8.153 LAEK	114 kW		01/95→09/96	☺ D0824LFL05; 4kW	8EA 738 029-001	Starter 257
10.163 LAC, LAEC, LARC, LAERC	114 - 118 kW		05/94→	05/94→; -12/95; ☺ D0824LFL02; 4kW	8EA 726 038-001	Starter 256
10.163 LC,10.163 LLC	114 - 118 kW		05/94→	03/00→; ☺ D0824LFL09; 4kW	8EA 726 038-001	Starter 256
10.163 LK, LRK, L-KI, LR-KI	114 - 118 kW		05/94→	08/95→; -03/97; ☺ D0824LFL06; 4kW	8EA 726 038-001	Starter 256
				05/94→; -12/95; ☺ D0824LFL02; 4kW	8EA 726 219-001	Starter 256
				03/00→; ☺ D0824LFL09; 4kW	8EA 726 219-001	Starter 256
				08/95→; -03/97; ☺ D0824LFL06; 4kW	8EA 726 219-001	Starter 256
				08/95→; -03/97; ☺ D0824LFL06; 4kW	8EA 737 912-001	Starter 257
				05/94→; -12/95; ☺ D0824LFL02; 4kW	8EA 737 912-001	Starter 257
				03/00→; ☺ D0824LFL09; 4kW	8EA 737 912-001	Starter 257
				03/00→; ☺ D0824LFL09; 4kW	8EA 738 029-001	Starter 257
				08/95→; -03/97; ☺ D0824LFL06; 4kW	8EA 738 029-001	Starter 257
				05/94→; -12/95; ☺ D0824LFL02; 4kW	8EA 738 029-001	Starter 257
10.163 LAK, LAEK, LARK, LAERK	114 - 118 kW		01/95→	03/00→; ☺ D0824LFL09; 4kW	8EA 726 038-001	Starter 256
				01/95→; -12/95; ☺ D0824LFL02; 4kW	8EA 726 038-001	Starter 256
				08/95→; -03/97; ☺ D0824LFL06; 4kW	8EA 726 038-001	Starter 256
				01/95→; -12/95; ☺ D0824LFL02; 4kW	8EA 726 219-001	Starter 256
				08/95→; -03/97; ☺ D0824LFL06; 4kW	8EA 726 219-001	Starter 256
				03/00→; ☺ D0824LFL09; 4kW	8EA 726 219-001	Starter 256
				08/95→; -03/97; ☺ D0824LFL06; 4kW	8EA 737 912-001	Starter 257
				03/00→; ☺ D0824LFL09; 4kW	8EA 737 912-001	Starter 257
				01/95→; -12/95; ☺ D0824LFL02; 4kW	8EA 737 912-001	Starter 257
				03/00→; ☺ D0824LFL09; 4kW	8EA 738 029-001	Starter 257
				08/95→; -03/97; ☺ D0824LFL06; 4kW	8EA 738 029-001	Starter 257
				01/95→; -12/95; ☺ D0824LFL02; 4kW	8EA 738 029-001	Starter 257
10.163 LC,10.163 LLC, LRC, LLRC (LE160C)	114 kW		09/00→	09/00→; -09/01; ☺ D0824LFL09; 4kW	8EA 737 912-001	Starter 257
				09/00→; -07/01; ☺ D0824LFL09; 4kW	8EA 738 029-001	Starter 257
10.163 LLS, LLRS	114 - 118 kW		05/94→	05/94→; -12/95; ☺ D0824LFL02; 4kW	8EA 726 038-001	Starter 256
				03/02→; ☺ D0824LFL09; 4kW	8EA 726 038-001	Starter 256
				05/94→; -03/97; ☺ D0824LFL06; 4kW	8EA 726 038-001	Starter 256
				05/94→; -03/97; ☺ D0824LFL06; 4kW	8EA 726 219-001	Starter 256

Manufacturer - Model	Power	Displ.	Year of Constr.	Remark	Part Number	Page
MAN - L 2000						10/93→
10.163 LLS, LLRS	114 - 118 kW		05/94→	05/94→; →12/95; ☺ D0824LFL02; 4kW	8EA 726 219-001	Starter 256
				03/02→; ☺ D0824LFL09; 4kW	8EA 726 219-001	Starter 256
				05/94→; →03/97; ☺ D0824LFL06; 4kW	8EA 737 912-001	Starter 257
				03/02→; ☺ D0824LFL09; 4kW	8EA 737 912-001	Starter 257
				05/94→; →12/95; ☺ D0824LFL02; 4kW	8EA 737 912-001	Starter 257
				05/94→; →03/97; ☺ D0824LFL06; 4kW	8EA 738 029-001	Starter 257
				03/02→; ☺ D0824LFL09; 4kW	8EA 738 029-001	Starter 257
				05/94→; →12/95; ☺ D0824LFL02; 4kW	8EA 738 029-001	Starter 257
10.185 LAC, LAEC, LARC, LAERC, LA-LA, LAE-LF (LE180C) 10.185 LAK, LAEK, LARK, LAERK (LE180C) 10.185 LK, LRK, L-KI, LR-KI (LE180C) 10.185 LLS, LLRS (LE180C) 8.185 LAC, LAEC, LARC, LAERC, LA-LF, LAE-LF (LE180C) 8.185 LAK, LAEK, LARK, LAERK (LE180C) 8.185 LK, LRK, L-KI, LR-KI (LE180C) 8.185 LLS, LLRS (LE180C)	132 kW		09/00→	☺ D0834LFL03; 4kW	8EA 737 912-001	Starter 257
				☺ D0834LFL03; 4kW	8EA 738 029-001	Starter 257
				09/00→; →08/02; ☺ D0834LFL03; 4kW	8EA 737 912-001	Starter 257
				09/00→; →08/02; ☺ D0834LFL03; 4kW	8EA 738 029-001	Starter 257
				09/00→		
				09/00→		
				09/00→		
				09/00→		
				09/00→		
				09/00→		
10.185 LC,10.185 LLC, LRC, LLRC (LE180C) 8.185 LC,8.185 LLC, LRC, LLRC, L-LF (LE180C) 9.185 LC,9.185 LLC, LRC, LLRC (LE180C) 9.185 LK, LRK, L-KI, LR-KI (LE180C) 9.185 LLS, LLRS (LE 180C)	132 kW		09/00→	09/00→; →08/02; ☺ D0834LFL03; 4kW	8EA 737 912-001	Starter 257
				09/00→; →08/02; ☺ D0834LFL03; 4kW	8EA 738 029-001	Starter 257
				09/00→		
				09/00→		
				09/00→		
				09/00→		
				09/00→		
				09/00→		
10.220 FOC,10.220 FOCL	162 kW		02/95→	02/95→; →02/01; ☺ D0826LFL03; 4kW	8EA 726 038-001	Starter 256
				02/95→; →02/01; ☺ D0826LFL03; 4kW	8EA 726 219-001	Starter 256
				02/95→; →02/01; ☺ D0826LFL03; 4kW	8EA 737 912-001	Starter 257
				02/95→; →02/01; ☺ D0826LFL03; 4kW	8EA 738 029-001	Starter 257
10.223 F, 10.223 FL 10.223 FA	162 kW		10/93→06/96	☺ D0826LFL06; 5.4kW	8EA 726 022-001	Starter 255
				☺ D0826LFL06; 4kW	8EA 726 038-001	Starter 256
				☺ D0826LFL06; 4kW	8EA 726 219-001	Starter 256
				☺ D0826LFL06; 4kW	8EA 737 912-001	Starter 257
				☺ D0826LFL06; 4kW	8EA 738 029-001	Starter 257
10.223 LAEC 8.223 LAEC	162 kW		01/95→06/96	☺ D0826LFL06; 4kW	8EA 726 038-001	Starter 256
10.223 LC,10.223 LLC	162 - 169 kW		10/93→06/96	☺ D0826LFL02; 5.4kW	8EA 726 022-001	Starter 255
				☺ D0826LFL02; 4kW	8EA 726 038-001	Starter 256
				05/94→; →06/96; ☺ D0826LFL06; 4kW	8EA 726 038-001	Starter 256
				☺ D0826LFL02; 4kW	8EA 726 038-001	Starter 256
10.223 LK 10.223 LLS	162 - 169 kW		10/93→06/96	☺ D0826LFL02; 4kW	8EA 726 038-001	Starter 256
				05/94→; →06/96; ☺ D0826LFL06; 4kW	8EA 726 038-001	Starter 256
10.224 F, 10.224 FL 10.224 FA	162 kW		05/94→	☺ D0826LFL03; 5.4kW	8EA 726 022-001	Starter 255
				☺ D0826LFL03; 4kW	8EA 726 038-001	Starter 256
				☺ D0826LFL03; 4kW	8EA 726 219-001	Starter 256
				☺ D0826LFL03; 4kW	8EA 737 912-001	Starter 257
				☺ D0826LFL03; 4kW	8EA 738 029-001	Starter 257
10.224 LAC, LAEC, LARC, LAERC 10.224 LAK, LAEK, LARK, LAERK	162 kW		01/95→	01/95→; →02/01; ☺ D0826LFL03; 4kW	8EA 726 038-001	Starter 256
				01/95→; →05/00; ☺ D0826LFL03; 4kW	8EA 726 219-001	Starter 256
				02/00→; →02/01; ☺ D0826LFL03; 4kW	8EA 737 912-001	Starter 257
				10/99→; →02/01; ☺ D0826LFL03; 4kW	8EA 738 029-001	Starter 257
10.224 LC,10.224 LLC, LRC, LLRC 10.224 LK, LRK, L-KI, LR-KI 10.224 LLS, LLRS	162 kW		05/94→	05/94→; →02/01; ☺ D0826LFL03; 4kW	8EA 726 038-001	Starter 256
				05/94→; →05/00; ☺ D0826LFL03; 4kW	8EA 726 219-001	Starter 256
				02/00→; →02/01; ☺ D0826LFL03; 4kW	8EA 737 912-001	Starter 257
				10/99→; →02/01; ☺ D0826LFL03; 4kW	8EA 738 029-001	Starter 257

Manufacturer - Model	Power	Displ.	Year of Constr.	Remark	Part Number	Page
MAN - L 2000						10/93→
10.225 LAC, LAEC, LARC, LAERC, LA-LF, LAE-LF (LE220C)	162 kW		09/00→	07/01→; ☺ D0836LFL02; 4kW	8EA 737 912-001	Starter 257
10.225 LAK, LAEK, LARK, LAERK (LE220C)	162 kW		09/00→	07/01→; ☺ D0836LFL02; 4kW	8EA 738 029-001	Starter 257
10.225 LK, LRK, L-KI, LR-KI(LE220C)	162 kW		09/00→			
10.225 LLS, LLRS (LE220C)	162 kW		09/00→			
12.225 LC, LLC (LE220C)	162 kW		09/99→			
8.225 LAC, LAEC, LARC, LAERC (LE220C)	162 kW		09/00→			
8.225 LAK, LAEK, LARK, LAERK (LE220C)	162 kW		09/00→			
8.225 LK, LRK, L-KI, LR-KI (LE220C)	162 kW		09/00→			
8.225 LLS, LLRS (LE220C)	162 kW		09/00→			
10.225 LC, 10.225 LLC, LRC, LLRC	162 kW		09/00→	☺ D0836LFL02; 4kW	8EA 726 219-001	Starter 256
10.225 LC, 10.225 LLC, LRC, LLRC (LE220C)	162 kW		09/00→	07/01→; -08/02; ☺ D0836LFL02; 4kW	8EA 737 912-001	Starter 257
				07/01→; -08/02; ☺ D0836LFL02; 4kW	8EA 738 029-001	Starter 257
12.185 LC, LLC (LE180C)	132 kW		09/99→	07/01→; ☺ D0834LFL03; 4kW	8EA 737 912-001	Starter 257
				07/01→; ☺ D0834LFL03; 4kW	8EA 738 029-001	Starter 257
8.103 LC, 8.103 LLC	75 kW		10/93→06/96	☺ D0824FL01; 4kW	8EA 737 912-001	Starter 257
				☺ D0824FL01; 4kW	8EA 738 029-001	Starter 257
8.103 LK	75 kW		10/93→06/96	☺ D0824FL01; 4kW	8EA 737 912-001	Starter 257
8.113 LC, 8.113 LLC	81 kW		08/95→	08/95→; -05/00; ☺ D0824LFL04; 4kW	8EA 726 038-001	Starter 256
8.113 LK, LRK, L-KI, LR-KI	81 kW		08/95→	08/95→; -05/00; ☺ D0824LFL04; 4kW	8EA 726 219-001	Starter 256
				05/00→; ☺ D0824LFL04; 4kW	8EA 737 912-001	Starter 257
				05/00→; ☺ D0824LFL04; 4kW	8EA 738 029-001	Starter 257
8.113 LC,8.113 LLC, LRC, LLRC, (LE110C)	83 kW		09/00→	09/00→; -09/01; ☺ D0824LFL08; 4kW	8EA 726 219-001	Starter 256
8.145 LC,8.145 LLC, L-LF (LE140C)	103 kW		09/00→	07/01→; -08/02; ☺ D0834LFL02; 4kW	8EA 737 912-001	Starter 257
				07/01→; -08/02; ☺ D0834LFL02; 4kW	8EA 738 029-001	Starter 257
8.150 FOC,8.150 FOCL	114 - 118 kW		02/95→	02/95→; -07/98; ☺ D0824LFO; 4kW	8EA 726 038-001	Starter 256
				02/95→; -07/98; ☺ D0824LFO; 4kW	8EA 726 219-001	Starter 256
				05/00→; ☺ D0824LFO; 4kW	8EA 737 912-001	Starter 257
				05/00→; ☺ D0824LFO; 4kW	8EA 738 029-001	Starter 257
8.153 LC,8.153 LLC	114 kW		10/93→07/97	10/93→; -01/95; ☺ D0824LFL01; 4kW	8EA 737 912-001	Starter 257
8.153 LK	114 kW		10/93→07/97	08/95→; -07/97; ☺ D0824LFL05; 4kW	8EA 737 912-001	Starter 257
				10/93→; -01/95; ☺ D0824LFL01; 4kW	8EA 738 029-001	Starter 257
				08/95→; -07/97; ☺ D0824LFL05; 4kW	8EA 738 029-001	Starter 257
8.163 LAC, LAEC, LARC, LAERC, LA-LF, LAE-LF	114 - 118 kW		01/95→	01/95→; -03/97; ☺ D0824LFL06; 4kW	8EA 726 038-001	Starter 256
				01/95→; -09/01; ☺ D0824LFL02; 4kW	8EA 726 038-001	Starter 256
				03/97→; -09/02; ☺ D0824LFL09; 4kW	8EA 726 038-001	Starter 256
				01/95→; -03/97; ☺ D0824LFL06; 4kW	8EA 726 219-001	Starter 256
				01/95→; -09/01; ☺ D0824LFL02; 4kW	8EA 726 219-001	Starter 256
				03/97→; -09/02; ☺ D0824LFL09; 4kW	8EA 726 219-001	Starter 256
				02/00→; -09/02; ☺ D0824LFL09; 4kW	8EA 737 912-001	Starter 257
				05/00→; -09/01; ☺ D0824LFL02; 4kW	8EA 737 912-001	Starter 257
				05/00→; ☺ D0824LFL06; 4kW	8EA 737 912-001	Starter 257
				10/99→; -09/02; ☺ D0824LFL09; 4kW	8EA 738 029-001	Starter 257
				05/00→; -09/01; ☺ D0824LFL02; 4kW	8EA 738 029-001	Starter 257
				05/00→; ☺ D0824LFL06; 4kW	8EA 738 029-001	Starter 257
8.163 LAEC	104 kW		08/95→03/97	☺ D0824LFL07; 4kW	8EA 737 912-001	Starter 257
9.163 LC	104 kW		08/95→03/97	☺ D0824LFL07; 4kW	8EA 738 029-001	Starter 257
9.163 LK	104 kW		08/95→03/97			
8.163 LC,8.163 LLC	114 - 118 kW		05/94→	05/94→; -12/95; ☺ D0824LFL02; 4kW	8EA 726 038-001	Starter 256
				05/94→; -03/97; ☺ D0824LFL06; 4kW	8EA 726 038-001	Starter 256
				03/97→; -09/02; ☺ D0824LFL09; 4kW	8EA 726 038-001	Starter 256
				05/94→; -03/97; ☺ D0824LFL06; 4kW	8EA 726 219-001	Starter 256
				05/94→; -12/95; ☺ D0824LFL02; 4kW	8EA 726 219-001	Starter 256
				03/97→; -09/02; ☺ D0824LFL09; 4kW	8EA 726 219-001	Starter 256
				08/95→; -03/97; ☺ D0824LFL06; 4kW	8EA 737 912-001	Starter 257
				02/00→; -09/02; ☺ D0824LFL09; 4kW	8EA 737 912-001	Starter 257
				10/99→; -09/02; ☺ D0824LFL09; 4kW	8EA 738 029-001	Starter 257
				08/95→; -03/97; ☺ D0824LFL06; 4kW	8EA 738 029-001	Starter 257
8.163 LC,8.163 LLC, LRC, LLRC, L-LF	104 kW		08/95→	08/95→; -03/01; ☺ D0824LFL07; 4kW	8EA 726 038-001	Starter 256
				08/95→; -03/01; ☺ D0824LFL07; 4kW	8EA 726 219-001	Starter 256
				02/00→; -03/01; ☺ D0824LFL07; 4kW	8EA 737 912-001	Starter 257
				10/99→; -03/01; ☺ D0824LFL07; 4kW	8EA 738 029-001	Starter 257

Manufacturer - Model	Power	Displ.	Year of Constr.	Remark	Part Number	Page				
MAN - L 2000						10/93→				
8.163 LC, 8.163 LLC (LE160C)	114 kW		09/00→	☺ D0824FL09; 4kW	8EA 726 038-001	Starter 256				
				☺ D0824FL09; 4kW	8EA 726 219-001	Starter 256				
				☺ D0824FL09; 4kW	8EA 737 912-001	Starter 257				
				☺ D0824FL09; 4kW	8EA 738 029-001	Starter 257				
8.163 LK, LRK, L-KI, LR-KI	114 - 118 kW		05/94→	05/94→; -09/01; ☺ D0824FL02; 4kW	8EA 726 038-001	Starter 256				
				03/97→; -02/02; ☺ D0824FL09; 4kW	8EA 726 038-001	Starter 256				
				05/94→; -03/97; ☺ D0824FL06; 4kW	8EA 726 038-001	Starter 256				
				05/94→; -03/97; ☺ D0824FL06; 4kW	8EA 726 219-001	Starter 256				
				03/97→; -02/02; ☺ D0824FL09; 4kW	8EA 726 219-001	Starter 256				
				05/94→; -09/01; ☺ D0824FL02; 4kW	8EA 726 219-001	Starter 256				
				02/00→; -02/02; ☺ D0824FL09; 4kW	8EA 737 912-001	Starter 257				
				10/99→; -02/02; ☺ D0824FL09; 4kW	8EA 738 029-001	Starter 257				
				8.163 LLS, LLRS	114 - 118 kW		05/94→	05/94→; -09/01; ☺ D0824FL02; 4kW	8EA 726 038-001	Starter 256
								05/94→; -03/97; ☺ D0824FL06; 4kW	8EA 726 038-001	Starter 256
03/97→; -09/02; ☺ D0824FL09; 4kW	8EA 726 038-001	Starter 256								
05/94→; -03/97; ☺ D0824FL06; 4kW	8EA 726 219-001	Starter 256								
03/97→; -01/00; ☺ D0824FL09; 4kW	8EA 726 219-001	Starter 256								
05/94→; -09/01; ☺ D0824FL02; 4kW	8EA 726 219-001	Starter 256								
05/94→; -09/01; ☺ D0824FL02; 4kW	8EA 737 912-001	Starter 257								
02/00→; -09/02; ☺ D0824FL09; 4kW	8EA 737 912-001	Starter 257								
08/95→; -03/97; ☺ D0824FL06; 4kW	8EA 737 912-001	Starter 257								
10/99→; -09/02; ☺ D0824FL09; 4kW	8EA 738 029-001	Starter 257								
8.220 FOC, 8.220 FOCL	162 kW		04/95→					04/95→; -09/01; ☺ D0826FL03; 4kW	8EA 726 038-001	Starter 256
								04/95→; -09/01; ☺ D0826FL03; 4kW	8EA 726 219-001	Starter 256
8.223 LC, 8.223 LLC 9.223 LK 9.223 LLS	162 - 169 kW		10/93→06/96	☺ D0826FL02; 4kW	8EA 726 038-001	Starter 256				
				05/94→; -06/96; ☺ D0826FL06; 4kW	8EA 726 038-001	Starter 256				
				☺ D0826FL02; 4kW	8EA 726 219-001	Starter 256				
8.223 LK	162 - 169 kW		10/93→06/96	05/94→; -01/95; ☺ D0826FL06; 4kW	8EA 726 038-001	Starter 256				
				05/94→; -01/95; ☺ D0826FL02; 4kW	8EA 726 038-001	Starter 256				
8.223 LLS	162 - 169 kW		10/93→06/96	☺ D0826FL06; 5.4kW	8EA 726 022-001	Starter 255				
				05/94→; -01/95; ☺ D0826FL06; 4kW	8EA 726 038-001	Starter 256				
				☺ D0826FL02; 4kW	8EA 726 038-001	Starter 256				
				☺ D0826FL06; 4kW	8EA 726 219-001	Starter 256				
				☺ D0826FL02; 4kW	8EA 726 219-001	Starter 256				
				☺ D0826FL06; 4kW	8EA 737 912-001	Starter 257				
				☺ D0826FL06; 4kW	8EA 738 029-001	Starter 257				
				01/95→; -09/99; ☺ D0826FL03; 4kW	8EA 726 038-001	Starter 256				
8.224 LAK, LAEK, LARK, LAERK	162 kW		01/95→	01/95→; -01/00; ☺ D0826FL03; 4kW	8EA 726 219-001	Starter 256				
				02/00→; -08/01; ☺ D0826FL03; 4kW	8EA 737 912-001	Starter 257				
				10/99→; -08/01; ☺ D0826FL03; 4kW	8EA 738 029-001	Starter 257				
				05/94→; -01/95; ☺ D0826FL03; 4kW	8EA 726 038-001	Starter 256				
8.224 LC, 8.224 LLC, LRC, LLRC	162 kW		05/94→	05/94→; -01/95; ☺ D0826FL03; 4kW	8EA 726 219-001	Starter 256				
				05/94→; -01/95; ☺ D0826FL03; 4kW	8EA 737 912-001	Starter 257				
				05/94→; -01/95; ☺ D0826FL03; 4kW	8EA 738 029-001	Starter 257				
				05/94→; -01/95; ☺ D0826FL03; 4kW	8EA 726 038-001	Starter 256				
8.224 LK, LRK, L-KI, LR-KI	162 kW		05/94→	05/94→; -09/99; ☺ D0826FL03; 4kW	8EA 726 038-001	Starter 256				
				05/94→; -01/00; ☺ D0826FL03; 4kW	8EA 726 219-001	Starter 256				
				02/00→; -09/01; ☺ D0826FL03; 4kW	8EA 737 912-001	Starter 257				
				10/99→; -09/01; ☺ D0826FL03; 4kW	8EA 738 029-001	Starter 257				
8.224 LLS, LLRS	162 kW		05/94→	05/94→; -09/99; ☺ D0826FL03; 4kW	8EA 726 038-001	Starter 256				
				05/94→; -01/00; ☺ D0826FL03; 4kW	8EA 726 219-001	Starter 256				
				02/00→; -03/01; ☺ D0826FL03; 4kW	8EA 737 912-001	Starter 257				
				10/99→; -03/01; ☺ D0826FL03; 4kW	8EA 738 029-001	Starter 257				
8.225 LC, 8.225 LLC, LRC, LLRC (LE220C)	162 kW		09/00→	07/01→; -08/02; ☺ D0836FL02; 4kW	8EA 737 912-001	Starter 257				
				07/01→; -08/02; ☺ D0826FL10; 4kW	8EA 737 912-001	Starter 257				
				07/01→; -08/02; ☺ D0826FL10; 4kW	8EA 738 029-001	Starter 257				
				07/01→; -08/02; ☺ D0836FL02; 4kW	8EA 738 029-001	Starter 257				
9.153 LC, 9.153 LLC	114 kW		10/93→06/96	10/93→; -01/95; ☺ D0824FL01; 4kW	8EA 737 912-001	Starter 257				
				08/95→; -06/96; ☺ D0824FL05; 4kW	8EA 737 912-001	Starter 257				
				10/93→; -01/95; ☺ D0824FL01; 4kW	8EA 738 029-001	Starter 257				
				08/95→; -06/96; ☺ D0824FL05; 4kW	8EA 738 029-001	Starter 257				
9.153 LK	114 kW		10/93→06/96	08/95→; -06/96; ☺ D0824FL05; 4kW	8EA 737 912-001	Starter 257				
				08/95→; -06/96; ☺ D0824FL05; 4kW	8EA 738 029-001	Starter 257				
9.153 LLS	114 kW		10/93→12/95	☺ D0824FL01; 4kW	8EA 726 038-001	Starter 256				
				08/95→; -06/96; ☺ D0824FL05; 4kW	8EA 726 038-001	Starter 256				
				☺ D0824FL01; 4kW	8EA 726 219-001	Starter 256				
				08/95→; -06/96; ☺ D0824FL05; 4kW	8EA 726 219-001	Starter 256				
9.163 LC, 9.163 LLC, LRC, LLRC	114 - 118 kW		05/94→	05/94→; -12/95; ☺ D0824FL02; 4kW	8EA 726 038-001	Starter 256				

Manufacturer - Model	Power	Displ.	Year of Constr.	Remark	Part Number	Page
MAN - L 2000						10/93→
9.163 LK, LRK, L-KI, LR-KI	114 - 118 kW		05/94→	03/97→; -09/99; ⚡ D0824FL09; 4kW	8EA 726 038-001	Starter 256
9.163 LLS, LLRS	114 - 118 kW		05/94→	05/94→; -03/97; ⚡ D0824FL06; 4kW	8EA 726 038-001	Starter 256
				05/94→; -12/95; ⚡ D0824FL02; 4kW	8EA 726 219-001	Starter 256
				05/94→; -03/97; ⚡ D0824FL06; 4kW	8EA 726 219-001	Starter 256
				03/97→; -01/00; ⚡ D0824FL09; 4kW	8EA 726 219-001	Starter 256
				02/00→; -09/01; ⚡ D0824FL09; 4kW	8EA 737 912-001	Starter 257
				10/99→; -09/01; ⚡ D0824FL09; 4kW	8EA 738 029-001	Starter 257
9.223 LC,9.223 LLC	162 - 169 kW		10/93→06/96	⚡ D0826FL02; 4kW	8EA 726 038-001	Starter 256
				05/94→; -06/96; ⚡ D0826FL06; 4kW	8EA 726 038-001	Starter 256
				⚡ D0826FL02; 4kW	8EA 726 219-001	Starter 256
				⚡ D0826FL02; 4kW	8EA 737 912-001	Starter 257
9.224 LC,9.224 LLC, LRC, LLRC	162 kW		05/94→	05/94→; -09/01; ⚡ D0826FL03; 4kW	8EA 726 038-001	Starter 256
9.224 LK, LRK, L-KI, LR-KI	162 kW		05/94→	05/94→; -09/01; ⚡ D0826FL03; 4kW	8EA 726 219-001	Starter 256
9.224 LLS, LLRS	162 kW		05/94→	02/00→; -09/01; ⚡ D0826FL03; 4kW	8EA 737 912-001	Starter 257
				10/99→; -09/01; ⚡ D0826FL03; 4kW	8EA 738 029-001	Starter 257
9.225 LC,9.225 LLC, LRC, LLRC (LE220C)	162 kW		09/00→	07/01→; -06/05; ⚡ D0836FL02; 4kW	8EA 737 912-001	Starter 257
9.225 LK, LRK, L-KI, LR-KI (LE220C)	162 kW		09/00→	07/01→; -06/05; ⚡ D0836FL02; 4kW	8EA 738 029-001	Starter 257
9.225 LLS, LLRS (LE220C)	162 kW		09/00→			
MAN - LION S COACH						09/95→
FRH 352,RH 353	257 kW		09/95→	09/95→; -09/01; ⚡ D2866LOH26; 5.4kW	8EA 726 022-001	Starter 255
				09/95→; -09/01; ⚡ D2866LOH26; 6kW	8EA 726 025-001	Starter 255
FRH 402,RH 403	294 kW		09/95→	09/95→; -09/01; ⚡ D2866LOH23; 5.4kW	8EA 726 022-001	Starter 255
				09/95→; -09/01; ⚡ D2866LOH23; 6kW	8EA 726 025-001	Starter 255
RH 402	294 kW		09/98→	09/98→; -09/01; ⚡ D2866LOH23; 5.4kW	8EA 726 022-001	Starter 255
				09/98→; -09/01; ⚡ D2866LOH23; 6kW	8EA 726 025-001	Starter 255
RH 463, RHC 464	338 kW		01/00→	01/00→; -09/01; ⚡ D2876LOH01; 5.4kW	8EA 726 022-001	Starter 255
				01/00→; -09/01; ⚡ D2876LOH03; 5.4kW	8EA 726 022-001	Starter 255
				01/00→; -09/01; ⚡ D2876LOH01; 6kW	8EA 726 025-001	Starter 255
				01/00→; -01/04; ⚡ D2876LOH02; 6kW	8EA 726 025-001	Starter 255
				01/00→; -09/01; ⚡ D2876LOH03; 6kW	8EA 726 025-001	Starter 255
RHC 414	301 kW		06/02→	09/02→; -09/06; ⚡ D2866LOH34; 5.4kW	8EA 726 022-001	Starter 255
				09/02→; -09/06; ⚡ D2866LOH34; 6kW	8EA 726 025-001	Starter 255
MAN - LION S COMFORT						09/96→
RN 313	228 kW		09/96→	09/96→; -03/98; ⚡ D2866LUH20; 5.4kW	8EA 726 022-001	Starter 255
				09/96→; -12/01; ⚡ D2866LUH26; 5.4kW	8EA 726 022-001	Starter 255
				09/96→; -12/01; ⚡ D2866LUH26; 6kW	8EA 726 025-001	Starter 255
				09/96→; -03/98; ⚡ D2866LUH20; 6kW	8EA 726 025-001	Starter 255
RN 353	257 kW		06/97→	06/97→; -03/98; ⚡ D2866LUH21; 5.4kW	8EA 726 022-001	Starter 255
				06/97→; -03/98; ⚡ D2866LUH21; 6kW	8EA 726 025-001	Starter 255
MAN - LION S STAR						01/93→
FRH 352,RH 353	257 kW		09/95→	09/95→; -11/99; ⚡ D2866LOH26; 5.4kW	8EA 726 022-001	Starter 255
				09/95→; -11/99; ⚡ D2866LOH26; 6kW	8EA 726 025-001	Starter 255
FRH 402,RH 403	294 kW		09/95→	09/95→; -09/01; ⚡ D2866LOH23; 5.4kW	8EA 726 022-001	Starter 255
				09/95→; -09/01; ⚡ D2866LOH23; 6kW	8EA 726 025-001	Starter 255
FRH 422	309 kW		01/93→09/96	⚡ D2866LOH20; 5.4kW	8EA 726 022-001	Starter 255
				⚡ D2866LOH20; 6kW	8EA 726 025-001	Starter 255
RH 464, RHS 464	301 kW		03/00→	10/01→; -09/06; ⚡ D2866LOH34; 5.4kW	8EA 726 022-001	Starter 255
				10/01→; -09/06; ⚡ D2866LOH34; 6kW	8EA 726 025-001	Starter 255
RH 464, RHS 464	301 kW		01/02→	01/02→; -09/06; ⚡ D2866LOH34; 5.4kW	8EA 726 022-001	Starter 255
				01/02→; -09/06; ⚡ D2866LOH34; 6kW	8EA 726 025-001	Starter 255
RH 414	338 kW		03/00→	10/01→; -09/06; ⚡ D2876LOH03; 5.4kW	8EA 726 022-001	Starter 255
				10/01→; -09/06; ⚡ D2876LOH03; 6kW	8EA 726 025-001	Starter 255
RH 464, RHS 464	338 kW		01/02→	01/02→; -09/06; ⚡ D2876LOH03; 5.4kW	8EA 726 022-001	Starter 255
				01/02→; -09/06; ⚡ D2876LOH03; 6kW	8EA 726 025-001	Starter 255
MAN - M 90						08/88→06/96
12.152 F,12.152 FL	110 - 114 kW		12/88→05/94	⚡ D0826F02; 4kW	8EA 726 038-001	Starter 256
12.152 FK	110 - 114 kW		12/88→05/94	⚡ D0826F01; 4kW	8EA 726 038-001	Starter 256
12.152 FS,12.152 FLS	110 - 114 kW		12/88→05/94	⚡ D0826F02; 4kW	8EA 726 219-001	Starter 256
14.152 F,14.152 FL	110 - 114 kW		12/88→04/94	⚡ D0826F01; 4kW	8EA 726 219-001	Starter 256
14.152 FK	110 - 114 kW		12/88→05/94			
14.152 FS,14.152 FLS	110 - 114 kW		12/88→05/94			
12.192 F,12.192 FL	140 kW		07/90→06/96	⚡ D0826LF01; 4kW	8EA 726 038-001	Starter 256
12.192 FK	140 kW		07/90→06/96	⚡ D0826LF07; 4kW	8EA 726 038-001	Starter 256
12.192 FS,12.192 FLS	140 kW		07/90→06/96	⚡ D0826LF05; 4kW	8EA 726 038-001	Starter 256

Manufacturer - Model	Power	Displ.	Year of Constr.	Remark	Part Number	Page
MAN - M 90					08/88→06/96	
12.192 F,12.192 FL	140 kW		07/90→06/96	☞ D0826LF07; 4kW	8EA 726 219-001	Starter 256
12.192 FK	140 kW		07/90→06/96	☞ D0826LF05; 4kW	8EA 726 219-001	Starter 256
12.192 FS,12.192 FLS	140 kW		07/90→06/96	☞ D0826LF01; 4kW	8EA 726 219-001	Starter 256
				☞ D0826LF07; 4kW	8EA 738 029-001	Starter 257
				☞ D0826LF01; 4kW	8EA 738 029-001	Starter 257
				☞ D0826LF05; 4kW	8EA 738 029-001	Starter 257
12.192 FA	140 kW		10/92→06/96	☞ D0826LF07; 4kW	8EA 726 038-001	Starter 256
12.192 FAK	140 kW		10/92→06/96	☞ D0826LF05; 4kW	8EA 726 038-001	Starter 256
				☞ D0826LF05; 4kW	8EA 726 219-001	Starter 256
				☞ D0826LF07; 4kW	8EA 726 219-001	Starter 256
				☞ D0826LF05; 4kW	8EA 738 029-001	Starter 257
				☞ D0826LF07; 4kW	8EA 738 029-001	Starter 257
12.222 F,12.222 FL	162 kW		05/94→06/96	☞ D0826LF11; 4kW	8EA 726 038-001	Starter 256
12.222 FA	162 kW		05/94→06/96	☞ D0826LF11; 4kW	8EA 726 219-001	Starter 256
12.222 FAK	162 kW		05/94→06/96	☞ D0826LF11; 4kW	8EA 738 029-001	Starter 257
12.222 FLS	162 kW		05/94→06/96	☞ D0826LF11; 4kW	8EA 738 029-001	Starter 257
12.232 F,12.232 FL	169 kW		08/88→06/96	☞ D0826LF08; 4kW	8EA 726 038-001	Starter 256
12.232 FK	169 kW		08/88→06/96	☞ D0826LF02; 4kW	8EA 726 038-001	Starter 256
12.232 FS,12.232 FLS	169 kW		08/88→06/96	☞ D0826LF08; 4kW	8EA 726 038-001	Starter 256
14.232 F,14.232 FL	169 kW		08/88→06/96	☞ D0826LF08; 4kW	8EA 726 219-001	Starter 256
14.232 FK	169 kW		08/88→06/96	☞ D0826LF08; 4kW	8EA 726 219-001	Starter 256
14.232 FS,14.232 FLS	169 kW		08/88→06/96	☞ D0826LF02; 4kW	8EA 726 219-001	Starter 256
17.232 FA	169 kW		02/89→06/96	☞ D0826LF08; 4kW	8EA 726 219-001	Starter 256
17.232 FAK	169 kW		02/89→06/96	☞ D0826LF08; 4kW	8EA 726 219-001	Starter 256
12.232 FA	169 kW		05/90→06/96	☞ D0826LF02; 4kW	8EA 726 038-001	Starter 256
12.232 FAK	169 kW		05/90→06/96	☞ D0826LF08; 4kW	8EA 726 038-001	Starter 256
				☞ D0826LF06; 4kW	8EA 726 038-001	Starter 256
				☞ D0826LF08; 4kW	8EA 726 219-001	Starter 256
				☞ D0826LF06; 4kW	8EA 726 219-001	Starter 256
				☞ D0826LF02; 4kW	8EA 726 219-001	Starter 256
				☞ D0826LF08; 4kW	8EA 738 029-001	Starter 257
				☞ D0826LF02; 4kW	8EA 738 029-001	Starter 257
				☞ D0826LF06; 4kW	8EA 738 029-001	Starter 257
12.262 F,12.262 FL	191 kW		08/95→06/96	☞ D0826LF13; 4kW	8EA 726 038-001	Starter 256
12.262 FK	191 kW		08/95→06/96	☞ D0826LF13; 4kW	8EA 726 219-001	Starter 256
12.262 FS,12.262 FLS	191 kW		08/95→06/96	☞ D0826LF13; 4kW	8EA 738 029-001	Starter 257
12.272 F,12.272 FL	198 kW		09/91→10/92	☞ D2865LF02; 5.4kW	8EA 726 022-001	Starter 255
12.272 FK	198 kW		09/91→10/92	☞ D2865LF02; 6kW	8EA 726 025-001	Starter 255
12.272 FS,12.272 FLS	198 kW		09/91→10/92			
14.272 F,14.272 FL	198 kW		09/91→10/92			
14.272 FK	198 kW		09/91→10/92			
14.272 FS,14.272 FLS	198 kW		09/91→10/92			
18.272 F,18.272 FL,18.272 FLL	198 kW		09/91→05/94			
18.272 FK	198 kW		09/91→05/94			
24.272 FNL,24.272 FVL	198 kW		09/91→05/94			
12.272 F,12.272 FL	198 kW		10/92→06/96	☞ D0826LF04; 4kW	8EA 726 038-001	Starter 256
12.272 FK	198 kW		10/92→06/96	☞ D0826LF04; 4kW	8EA 726 219-001	Starter 256
12.272 FS,12.272 FLS	198 kW		10/92→06/96	☞ D0826LF04; 4kW	8EA 738 029-001	Starter 257
12.272 FA	198 kW		10/93→04/95	☞ D0826LF04; 4kW	8EA 726 038-001	Starter 256
12.272 FAK	198 kW		10/93→04/95	☞ D0826LF04; 4kW	8EA 726 219-001	Starter 256
17.272 FLS	198 kW		10/92→05/95			
14.152 F,14.152 FL	114 kW		05/94→06/96	☞ D0824LF01; 4kW	8EA 726 219-001	Starter 256
14.152 FS,14.152 FLS	114 kW		05/94→06/96	☞ D0824LF01; 4kW	8EA 737 912-001	Starter 257
				☞ D0824LF01; 4kW	8EA 738 029-001	Starter 257
14.152 FK	114 kW		05/94→06/96	☞ D0824LF01; 4kW	8EA 726 219-001	Starter 256
				☞ D0824LF01; 4kW	8EA 738 029-001	Starter 257
14.162 F,14.162 FL	118 kW		08/95→06/96	☞ D0824LF02; 4kW	8EA 726 219-001	Starter 256
14.162 FK	118 kW		08/95→06/96	☞ D0824LF02; 4kW	8EA 738 029-001	Starter 257
14.162 FS,14.162 FLS	118 kW		08/95→06/96			
14.192 F,14.192 FL	137 kW		08/88→06/90	☞ D0826TF; 4kW	8EA 726 038-001	Starter 256
14.192 FK	137 kW		08/88→06/90	☞ D0826TF; 4kW	8EA 726 219-001	Starter 256
14.192 FS,14.192 FLS	137 kW		08/88→06/90			
17.192 F,17.192 FL	137 kW		08/88→06/90			
17.192 FA	137 kW		02/89→06/90			
17.192 FAK	137 kW		02/89→06/90			
17.192 FK	137 kW		08/88→06/90			
17.192 FS,17.192 FLS	137 kW		08/88→06/90			

Manufacturer - Model	Power	Displ.	Year of Constr.	Remark	Part Number	Page
MAN - M 90					08/88→06/96	
14.192 F,14.192 FL	140 kW		07/90→06/96	☺ D0826LF01; 4kW	8EA 726 219-001	Starter 256
14.192 FK	140 kW		07/90→06/96	☺ D0826LF07; 4kW	8EA 726 219-001	Starter 256
14.192 FS,14.192 FLS	140 kW		07/90→06/96	☺ D0826LF05; 4kW	8EA 726 219-001	Starter 256
18.192 F,18.192 FL,18.192 FLL	140 kW		09/90→06/96	☺ D0826LF07; 4kW	8EA 738 029-001	Starter 257
18.192 FK	140 kW		09/90→06/96	☺ D0826LF05; 4kW	8EA 738 029-001	Starter 257
				☺ D0826LF01; 4kW	8EA 738 029-001	Starter 257
14.192 FA	137 kW		08/88→06/90	☺ D0826TF; 4kW	8EA 737 912-001	Starter 257
				☺ D0826TF; 4kW	8EA 738 029-001	Starter 257
14.222 F,14.222 FL	162 kW		05/94→06/96	☺ D0826LF11; 4kW	8EA 726 219-001	Starter 256
14.222 FK	162 kW		05/94→06/96	☺ D0826LF11; 4kW	8EA 738 029-001	Starter 257
14.222 FLS	162 kW		05/94→06/96			
18.222 F,18.222 FL,18.222 FLL	162 kW		05/94→06/96			
18.222 FK	162 kW		05/94→06/96			
24.222 FNL,24.222 FNLL,24.222 FVL	162 kW		05/94→06/96			
14.232 F,14.232 FL	160 kW		05/90→04/95	☺ D0826LF/217/SILENT; 4kW	8EA 726 038-001	Starter 256
14.232 FS,14.232 FLS	160 kW		05/90→04/95	☺ D0826LF/217/SILENT; 4kW	8EA 726 219-001	Starter 256
17.232 F,17.232 FL	160 kW		05/90→04/95			
17.232 FA	160 kW		05/90→04/95			
17.232 FAK	160 kW		05/90→04/95			
17.232 FK	160 kW		05/90→01/91			
17.232 FS,17.232 FLS	160 kW		05/90→04/95			
24.232 FNL	160 kW		05/90→04/95			
14.262 F,14.262 FL	191 kW		08/95→06/96	☺ D0826LF13; 4kW	8EA 726 219-001	Starter 256
14.262 FK	191 kW		08/95→06/96	☺ D0826LF13; 4kW	8EA 738 029-001	Starter 257
14.262 FS,14.262 FLS	191 kW		08/95→06/96			
18.262 F,18.262 FL,18.262 FLL	191 kW		08/95→06/96			
18.262 FK	191 kW		08/95→06/96			
24.262 FNL,24.262 FNLL,24.262 FVL	191 kW		08/95→06/96			
14.272 F,14.272 FL	198 kW		10/92→06/96	☺ D0826LF04; 4kW	8EA 726 219-001	Starter 256
14.272 FK	198 kW		10/92→06/96	☺ D0826LF04; 4kW	8EA 738 029-001	Starter 257
14.272 FS,14.272 FLS	198 kW		12/92→06/96			
18.272 F,18.272 FL,18.272 FLL	198 kW		10/92→06/96			
18.272 FK	198 kW		10/92→06/96			
24.272 FNL,24.272 FNLL,24.272 FVL	198 kW		10/92→06/96			
17.192 F,17.192 FL	140 kW		07/90→04/95	☺ D0826LF05; 4kW	8EA 726 038-001	Starter 256
17.192 FS,17.192 FLS	140 kW		07/90→04/95	☺ D0826LF01; 4kW	8EA 726 038-001	Starter 256
				☺ D0826LF05; 4kW	8EA 726 219-001	Starter 256
				☺ D0826LF01; 4kW	8EA 726 219-001	Starter 256
17.192 FA	140 kW		07/90→06/96	☺ D0826LF01; 4kW	8EA 726 219-001	Starter 256
17.192 FAK	140 kW		07/90→06/96	☺ D0826LF07; 4kW	8EA 726 219-001	Starter 256
				☺ D0826LF05; 4kW	8EA 726 219-001	Starter 256
				10/92→; →04/95; ☺ D0826LF05; 4kW	8EA 737 912-001	Starter 257
				☺ D0826LF07; 4kW	8EA 738 029-001	Starter 257
				☺ D0826LF05; 4kW	8EA 738 029-001	Starter 257
				☺ D0826LF01; 4kW	8EA 738 029-001	Starter 257
17.192 FK	140 kW		07/90→01/91	☺ D0826LF01; 4kW	8EA 726 038-001	Starter 256
				☺ D0826LF01; 4kW	8EA 726 219-001	Starter 256
17.222 FA	162 kW		05/94→06/96	☺ D0826LF11; 4kW	8EA 726 219-001	Starter 256
17.222 FAK	162 kW		05/94→06/96	☺ D0826LF11; 4kW	8EA 737 912-001	Starter 257
				☺ D0826LF11; 4kW	8EA 738 029-001	Starter 257
17.232 F,17.232 FL	169 kW		08/88→04/95	☺ D0826LF06; 4kW	8EA 726 038-001	Starter 256
17.232 FS,17.232 FLS	169 kW		08/88→04/95	☺ D0826LF02; 4kW	8EA 726 038-001	Starter 256
				☺ D0826LF02; 4kW	8EA 726 219-001	Starter 256
				☺ D0826LF06; 4kW	8EA 726 219-001	Starter 256
17.232 FK	169 kW		08/88→01/91	☺ D0826LF02; 4kW	8EA 726 038-001	Starter 256
				☺ D0826LF02; 4kW	8EA 726 219-001	Starter 256
17.272 FLS	198 kW		09/91→05/95	☺ D0826LF02; 4kW	8EA 726 022-001	Starter 255
				☺ D2865LF02; 6kW	8EA 726 025-001	Starter 255
18.232 F,18.232 FL,18.232 FLL	169 kW		09/90→06/96	☺ D0826LF02; 4kW	8EA 726 219-001	Starter 256
18.232 FK	169 kW		09/90→06/96	☺ D0826LF08; 4kW	8EA 726 219-001	Starter 256
				☺ D0826LF08; 4kW	8EA 726 219-001	Starter 256
				☺ D0826LF08; 4kW	8EA 738 029-001	Starter 257
				☺ D0826LF08; 4kW	8EA 738 029-001	Starter 257
				☺ D0826LF02; 4kW	8EA 738 029-001	Starter 257

Manufacturer - Model	Power	Displ.	Year of Constr.	Remark	Part Number	Page				
MAN - M 90						08/88→06/96				
24.192 FNL,24.192 FNLL,24.192 FVL	140 kW		07/89→06/96	☺ D0826LF07; 4kW	8EA 726 038-001	Starter 256				
				☺ D0826LF05; 4kW	8EA 726 038-001	Starter 256				
				☺ D0826LF01; 4kW	8EA 726 038-001	Starter 256				
				☺ D0826LF05; 4kW	8EA 726 219-001	Starter 256				
				☺ D0826LF01; 4kW	8EA 726 219-001	Starter 256				
24.232 FNL,24.232 FNLL,24.232 FVL	169 kW		07/89→06/96	☺ D0826LF02; 4kW	8EA 726 038-001	Starter 256				
				☺ D0826LF08; 4kW	8EA 726 219-001	Starter 256				
				☺ D0826LF06; 4kW	8EA 726 219-001	Starter 256				
				☺ D0826LF02; 4kW	8EA 726 219-001	Starter 256				
				☺ D0826LF08; 4kW	8EA 738 029-001	Starter 257				
				☺ D0826LF06; 4kW	8EA 738 029-001	Starter 257				
MAN - M 2000 L						08/95→				
12.163 LC, LLC, LRC, LLRC	114 kW		08/95→	08/95→; -08/01; ☺ D0824LFL09; 4kW	8EA 737 912-001	Starter 257				
12.163 LK, LRK	114 kW		08/95→	08/95→; -08/01; ☺ D0824LFL06; 4kW	8EA 737 912-001	Starter 257				
14.163 LC, LLC, LRC, LLRC	114 kW		08/95→	08/95→; -07/01; ☺ D0824LFL06; 4kW	8EA 738 029-001	Starter 257				
14.163 LK, LRK	114 kW		08/95→	08/95→; -07/01; ☺ D0824LFL09; 4kW	8EA 738 029-001	Starter 257				
12.185 LC, LLC, LRC, LLRC	132 - 136 kW		05/01→	☺ D0834LFL03; 4kW	8EA 737 912-001	Starter 257				
				☺ D0834LFL03; 4kW	8EA 738 029-001	Starter 257				
12.224, 12.225, LK, LRK	162 kW		08/95→	08/95→; -08/01; ☺ D0826LFL10; 4kW	8EA 726 038-001	Starter 256				
				08/95→; -08/01; ☺ D0826LFL03; 4kW	8EA 726 038-001	Starter 256				
				02/00→; -08/01; ☺ D0826LFL10; 4kW	8EA 737 912-001	Starter 257				
				10/99→; -08/01; ☺ D0826LFL10; 4kW	8EA 738 029-001	Starter 257				
12.224 LC, LLC, LRC, LLRC 14.224 LAC, LARC 14.224 LAK, LARK 14.224 LC, LLC, LLLC, LRC, LLRC, LLLRC 14.224 LK, LRK 15.224 LC, LLC, LLLC, LRC, LLRC, LLLRC 15.224 LK, LRK 18.224, 18.225, LAC, LARC 18.224, 18.225, LAK, LARK 18.224, 18.225, LC, LLC, LLLC, LRC, LLRC, LLLRC 18.224, 18.225, LK, LLK, LRK, LLRK	162 kW		08/95→ 08/95→ 08/95→ 08/95→ 08/95→ 08/95→ 08/95→ 08/95→ 08/95→ 08/95→ 08/95→ 08/95→ 08/95→ 08/95→	08/95→; -09/01; ☺ D0826LFL10; 4kW	8EA 726 038-001	Starter 256				
				08/95→; -09/01; ☺ D0826LFL03; 4kW	8EA 726 038-001	Starter 256				
				02/00→; -09/01; ☺ D0826LFL10; 4kW	8EA 737 912-001	Starter 257				
				10/99→; -09/01; ☺ D0826LFL10; 4kW	8EA 738 029-001	Starter 257				
				09/00→; -09/01; ☺ D0836LFL02; 4kW	8EA 726 038-001	Starter 256				
				09/00→; -08/02; ☺ D0836LFL02; 4kW	8EA 737 912-001	Starter 257				
				07/01→; -08/02; ☺ D0836LFL02; 4kW	8EA 738 029-001	Starter 257				
				4kW	8EA 726 219-001	Starter 256				
				07/01→; ☺ D0836LFL05; 4kW	8EA 737 912-001	Starter 257				
				07/01→; ☺ D0836LFL05; 4kW	8EA 738 029-001	Starter 257				
				14.263, 14.264 LAC, LARC 14.263, 14.264 LAK, LARK 14.263, 14.264 LC, LLC, LLLC, LRC, LLRC, LLLRC 14.263, 14.264 LK, LRK 15.263, 15.264 LC, LLC, LLLC, LRC, LLRC, LLLRC 15.263, 15.264 LK, LRK 18.263, 18.264, LAC, LARC 18.263, 18.264, LAK, LARK 18.263, 18.264, LC, LLC, LLLC, LRC, LLRC, LLLRC 18.263, 18.264, LK, LLK, LRK, LLRK	191 kW		08/95→ 08/95→ 08/95→ 08/95→ 08/95→ 08/95→ 08/95→ 08/95→ 08/95→ 08/95→	08/95→; -09/01; ☺ D0826LFL09; 4kW	8EA 726 038-001	Starter 256
								02/00→; -09/01; ☺ D0826LFL09; 4kW	8EA 737 912-001	Starter 257
								10/99→; -09/01; ☺ D0826LFL09; 4kW	8EA 738 029-001	Starter 257
								06/98→; -01/00; ☺ D0836LFL01; 4kW	8EA 726 219-001	Starter 256
02/00→; -09/01; ☺ D0836LFL01; 4kW	8EA 737 912-001	Starter 257								
06/98→; -09/01; ☺ D0836LFL01; 4kW	8EA 738 029-001	Starter 257								
14.284, 14.285, LAC, LARC 14.284, 14.285, LAK, LARK 14.284, 14.285, LA-LF 15.284 LC, LLC, LLLC, LRC, LLRC, LLLRC 15.284 LK, LRK 18.284, 18.285, LK, LLK, LRK, LLRK 18.284, 18.285, L-KO, LR-KO 18.284 LAC, LARC 18.284 LAK, LARK 18.284 LC, LLC, LLLC, LRC, LLRC, LLLRC	206 kW		06/98→ 06/98→ 06/98→ 06/98→ 06/98→ 06/98→ 06/98→ 06/98→					06/98→; -01/00; ☺ D0836LFL01; 4kW	8EA 726 219-001	Starter 256
								02/00→; -09/01; ☺ D0836LFL01; 4kW	8EA 737 912-001	Starter 257
								06/98→; -09/01; ☺ D0836LFL01; 4kW	8EA 738 029-001	Starter 257
								06/98→; -01/00; ☺ D0836LFL01; 4kW	8EA 726 219-001	Starter 256
				02/00→; -09/01; ☺ D0836LFL01; 4kW	8EA 737 912-001	Starter 257				
				06/98→; -09/01; ☺ D0836LFL01; 4kW	8EA 738 029-001	Starter 257				
				06/98→; -01/00; ☺ D0836LFL01; 4kW	8EA 726 219-001	Starter 256				
				02/00→; -09/01; ☺ D0836LFL01; 4kW	8EA 737 912-001	Starter 257				

Manufacturer - Model	Power	Displ.	Year of Constr.	Remark	Part Number	Page
MAN - M 2000 L						08/95→
14.284, 14.285, LK, LRK	206 kW		10/98→	10/98→; -01/00; ⚡ D0836LF01; 4kW	8EA 726 219-001	Starter 256
14.284 LC, LLC, LLLC, LRC, LLRC, LLLRC	206 kW		10/98→	02/00→; -09/01; ⚡ D0836LF01; 4kW	8EA 737 912-001	Starter 257
				10/98→; -09/01; ⚡ D0836LF01; 4kW	8EA 738 029-001	Starter 257
14.285 LC, LLC, LLLC, LRC, LLRC, LLLRC, (LE280B)	206 kW		09/00→	⚡ D0836LF03; 4kW	8EA 737 912-001	Starter 257
				⚡ D0836LF03; 4kW	8EA 738 029-001	Starter 257
15.163 LC, LLC, LRC	114 kW		08/95→	08/95→; -09/01; ⚡ D0824LFL09; 4kW	8EA 737 912-001	Starter 257
15.163 LK, LRK	114 kW		08/95→	08/95→; -09/01; ⚡ D0824LFL06; 4kW	8EA 737 912-001	Starter 257
				08/95→; -07/01; ⚡ D0824LFL06; 4kW	8EA 738 029-001	Starter 257
				08/95→; -07/01; ⚡ D0824LFL09; 4kW	8EA 738 029-001	Starter 257
15.225 LC, LLC, LLLC, LRC, LLRC, LLLRC, (LE220B)	162 kW		09/99→	09/00→; -09/01; ⚡ D0836LFL02; 4kW	8EA 726 038-001	Starter 256
				09/00→; -09/01; ⚡ D0836LFL02; 4kW	8EA 737 912-001	Starter 257
				09/02→; ⚡ D0836LFL02; 4kW	8EA 738 029-001	Starter 257
15.225 LK, LRK, (LE220B)	162 kW		09/99→	09/00→; -09/01; ⚡ D0836LFL02; 4kW	8EA 726 038-001	Starter 256
				09/01→; ⚡ D0836LFL02; 4kW	8EA 737 912-001	Starter 257
				09/02→; ⚡ D0836LFL02; 4kW	8EA 738 029-001	Starter 257
15.255 LC, LLC, LLLC, LRC, LLRC, LLLRC, (LE250B)	180 kW		09/99→	07/01→; -08/02; ⚡ D0836LFL05; 4kW	8EA 737 912-001	Starter 257
15.255 LK, LRK, (LE250B)	180 kW		09/99→	07/01→; -08/02; ⚡ D0836LFL05; 4kW	8EA 738 029-001	Starter 257
15.285 LC, LLC, LLLC, LRC, LLRC, LLLRC, (LE280B)	206 kW		09/99→	09/00→; -09/01; ⚡ D0836LFL03; 4kW	8EA 737 912-001	Starter 257
				09/00→; -09/01; ⚡ D0836LFL03; 4kW	8EA 738 029-001	Starter 257
15.285 LK, LRK, (LE280B)	206 kW		09/99→	09/00→; -09/02; ⚡ D0836LFL03; 4kW	8EA 737 912-001	Starter 257
				09/00→; -09/02; ⚡ D0836LFL03; 4kW	8EA 738 029-001	Starter 257
18.255 LC, LLC, LLLC, LRC, LLRC, LLLRC, (LE250B)	180 kW		09/99→	09/02→; ⚡ D0836LFL05; 4kW	8EA 737 912-001	Starter 257
				09/02→; ⚡ D0836LFL05; 4kW	8EA 738 029-001	Starter 257
18.285 LAC, LARC (LE280B)	206 kW		09/99→	09/02→; ⚡ D0836LFL03; 4kW	8EA 737 912-001	Starter 257
18.285 LAK, LARK, (LE280B)	206 kW		09/99→	09/02→; ⚡ D0836LFL03; 4kW	8EA 738 029-001	Starter 257
18.285 LC, LLC, LLLC, LRC, LLRC, LLLRC, (LE280B)	206 kW		09/99→	09/02→; ⚡ D0836LFL03; 4kW	8EA 738 029-001	Starter 257
MAN - M 2000 M						08/95→
14.224 MAK	162 kW		08/95→12/05	08/95→; -03/97; ⚡ D0826LF15; 4kW	8EA 726 038-001	Starter 256
14.224 MC, MLC, MLLC	162 kW		08/95→12/05	08/95→; -09/01; ⚡ D0826LF18; 4kW	8EA 726 038-001	Starter 256
14.224 MK	162 kW		08/95→12/05	08/95→; -09/01; ⚡ D0826LF18; 4kW	8EA 726 219-001	Starter 256
14.224 MLS, MLRS	162 kW		08/95→12/05	08/95→; -03/97; ⚡ D0826LF15; 4kW	8EA 726 219-001	Starter 256
18.224 MAC, MARC	162 kW		08/95→12/05	02/00→; -09/01; ⚡ D0826LF18; 4kW	8EA 737 912-001	Starter 257
18.224 MC, MLC, MLLC, MRC, MLRC, MLLRC	162 kW		08/95→12/05	10/99→; -09/01; ⚡ D0826LF18; 4kW	8EA 738 029-001	Starter 257
18.224 MLS, MLRS	162 kW		08/95→12/05			
14.225 MLS, MLRS	162 kW		02/03→	⚡ D0836LF04; 4kW	8EA 737 912-001	Starter 257
18.225 MAC, MARC	162 kW		02/03→	⚡ D0836LF04; 4kW	8EA 738 029-001	Starter 257
14.255 MLS, MLRS	180 kW		10/00→	⚡ D0836LF05; 4kW	8EA 726 219-001	Starter 256
18.255 MLS, MLRS	180 kW		10/00→	⚡ D0836LF05; 4kW	8EA 737 912-001	Starter 257
14.264 MC, MLC, MLLC	191 kW		08/95→12/05	08/95→; -01/00; ⚡ D0826LF17; 4kW	8EA 726 219-001	Starter 256
				02/00→; -09/01; ⚡ D0826LF17; 4kW	8EA 737 912-001	Starter 257
				08/95→; -09/01; ⚡ D0826LF17; 4kW	8EA 738 029-001	Starter 257
14.264 MLS, MLRS	191 kW		08/95→12/05	08/95→; -09/01; ⚡ D0826LF17; 4kW	8EA 726 038-001	Starter 256
18.264 MAC, MARC	191 kW		08/95→12/05	08/95→; -09/01; ⚡ D0826LF17; 4kW	8EA 726 219-001	Starter 256
18.264 MAK, MARK	191 kW		08/95→12/05			
18.264 MC, MLC, MLLC, MRC, MLRC, MLLRC	191 kW		08/95→12/05			
18.264 MK, 18.264 MLK, MRK, MLRK	191 kW		08/95→12/05			
18.264 MLS, MLRS	191 kW		08/95→12/05			
25.264 MNLC, MNLLC, MNLRC, MNLLRC, MVLC	191 kW		08/95→12/05			
14.284 MAK	206 kW		06/98→12/05	06/98→; -01/00; ⚡ D0836LF01; 4kW	8EA 726 219-001	Starter 256
14.284 MA-KO, MA-LF	206 kW		06/98→12/05	02/00→; -09/01; ⚡ D0836LF01; 4kW	8EA 737 912-001	Starter 257
14.284 MC, MLC, MLLC	206 kW		06/98→12/05	06/98→; -09/01; ⚡ D0836LF01; 4kW	8EA 738 029-001	Starter 257
14.284 MLS, MLRS	206 kW		06/98→12/05			
18.284 MAC, MARC	206 kW		06/98→12/05			
18.284 MAK, MARK	206 kW		06/98→12/05			
18.284 MC, MLC, MLLC, MRC, MLRC, LLRC	206 kW		06/98→12/05			
18.284 MK, 18.284 MLK, MRK, MLRK	206 kW		06/98→12/05			
18.284 MLS, MLRS	206 kW		06/98→12/05			
14.285 MLC, MLLC (ME280C)	206 kW		09/99→12/05	07/01→; -08/02; ⚡ D0836LFL03; 4kW	8EA 737 912-001	Starter 257
				07/01→; -08/02; ⚡ D0836LFL03; 4kW	8EA 738 029-001	Starter 257

Manufacturer - Model	Power	Displ.	Year of Constr.	Remark	Part Number	Page
MAN - M 2000 M						08/95→
18.224 MAK, MARK	162 kW		08/95→12/05	08/95→; -03/97; ☺ D0826LF15; 4kW	8EA 726 038-001	Starter 256
				08/95→; -09/99; ☺ D0826LF18; 4kW	8EA 726 038-001	Starter 256
				08/95→; -03/97; ☺ D0826LF15; 4kW	8EA 726 219-001	Starter 256
				08/95→; -09/01; ☺ D0826LF18; 4kW	8EA 726 219-001	Starter 256
				02/00→; -09/01; ☺ D0826LF18; 4kW	8EA 737 912-001	Starter 257
18.224 MK, 18.224 MLK, MRK, MLRK	162 kW		08/95→12/05	08/95→; -03/97; ☺ D0826LF15; 4kW	8EA 726 038-001	Starter 256
				08/95→; -09/99; ☺ D0826LF18; 4kW	8EA 726 038-001	Starter 256
				08/95→; -03/97; ☺ D0826LF15; 4kW	8EA 726 219-001	Starter 256
				08/95→; -01/00; ☺ D0826LF18; 4kW	8EA 726 219-001	Starter 256
				02/00→; -09/01; ☺ D0826LF18; 4kW	8EA 737 912-001	Starter 257
25.224 MNLC, MNLLC, MNLRC, MNLLRC, MVLC	162 kW		08/95→12/05	08/95→; -03/97; ☺ D0826LF15; 4kW	8EA 726 038-001	Starter 256
				08/95→; -09/99; ☺ D0826LF18; 4kW	8EA 726 038-001	Starter 256
				08/95→; -01/00; ☺ D0826LF18; 4kW	8EA 726 219-001	Starter 256
				08/95→; -03/97; ☺ D0826LF15; 4kW	8EA 726 219-001	Starter 256
				02/00→; ☺ D0826LF18; 4kW	8EA 737 912-001	Starter 257
25.285 MNLC, MNLLC, MNLRC, MNLLRC, MVLC	206 kW		02/03→	☺ D0836LF03; 4kW	8EA 737 912-001	Starter 257
				☺ D0836LF03; 4kW	8EA 738 029-001	Starter 257
MAN - NG						08/92→
NG 262	191 kW		06/97→07/98	☺ D2865LUH09; 5.4kW	8EA 726 022-001	Starter 255
				☺ D2865LUH09; 6kW	8EA 726 025-001	Starter 255
NG 262, NG 263	191 kW		07/98→	07/98→; -12/01; ☺ D2866LUH22; 5.4kW	8EA 726 022-001	Starter 255
				07/98→; -12/01; ☺ D2866LUH22; 6kW	8EA 726 025-001	Starter 255
NG 262, NG 272	191 - 198 kW		08/92→07/98	08/92→; -09/95; ☺ D0826LUH01; 5.4kW	8EA 726 022-001	Starter 255
				08/92→; -09/95; ☺ D0826LUH01; 4kW	8EA 726 219-001	Starter 256
NG 312	228 kW		09/95→07/98	☺ D2865LUH07; 5.4kW	8EA 726 022-001	Starter 255
				☺ D2865LUH07; 6kW	8EA 726 025-001	Starter 255
NG 312, NG 313	228 kW		07/98→	07/98→; -12/01; ☺ D2866LUH26; 5.4kW	8EA 726 022-001	Starter 255
				07/98→; -12/01; ☺ D2866LUH26; 6kW	8EA 726 025-001	Starter 255
MAN - NL						09/89→
NL 202	157 kW		09/89→04/94	☺ D0826LUH; 5.4kW	8EA 726 022-001	Starter 255
NL 202, NL 222, NL 223	157 - 162 kW		08/92→	11/95→; -11/99; ☺ D0826LUH12; 5.4kW	8EA 726 022-001	Starter 255
				08/92→; -03/97; ☺ D0826LUH03; 5.4kW	8EA 726 022-001	Starter 255
				07/98→; -09/01; ☺ D0826LUH12; 5.4kW	8EA 726 022-001	Starter 255
				08/92→; -04/01; ☺ D0826LUH03; 6kW	8EA 726 025-001	Starter 255
				11/95→; -11/99; ☺ D0826LUH12; 4kW	8EA 726 219-001	Starter 256
				07/98→; -09/01; ☺ D0826LUH12; 4kW	8EA 726 219-001	Starter 256
NL 202, NL 262, NL 263	184 kW		04/91→	04/94→; -03/97; ☺ D0826LUH; 4kW	8EA 726 219-001	Starter 256
				04/94→; -03/97; ☺ D0826LUH; 4kW	8EA 737 912-001	Starter 257
				04/94→; -02/97; ☺ D0826LUH; 4kW	8EA 738 029-001	Starter 257
NL 243	180 kW			01/02→; ☺ E2866DUH04; 5.4kW	8EA 726 022-001	Starter 255
				01/02→; ☺ E2866DUH04; 6kW	8EA 726 025-001	Starter 255
NL 262	191 kW		06/97→	06/97→; -07/98; ☺ D2865LUH09; 5.4kW	8EA 726 022-001	Starter 255
				06/97→; -07/98; ☺ D2865LUH09; 6kW	8EA 726 025-001	Starter 255
NL 262, NL 263	191 kW		07/98→	07/98→; -09/01; ☺ D2866LUH22; 5.4kW	8EA 726 022-001	Starter 255
				07/98→; -09/01; ☺ D2866LUH22; 6kW	8EA 726 025-001	Starter 255
NL 312	228 kW		11/95→07/98	☺ D2865LUH07; 5.4kW	8EA 726 022-001	Starter 255
				☺ D2865LUH07; 6kW	8EA 726 025-001	Starter 255
NL 313	228 kW		07/98→	07/98→; -12/01; ☺ D2866LUH26; 5.4kW	8EA 726 022-001	Starter 255
				07/98→; -12/01; ☺ D2866LUH26; 6kW	8EA 726 025-001	Starter 255
MAN - NM						08/87→
NM 152	110 kW		05/90→10/93	☺ D0826OH02; 4kW	8EA 726 038-001	Starter 256
				☺ D0826OH02; 4kW	8EA 726 219-001	Starter 256
NM 152	114 kW		04/92→03/97	04/92→; -05/96; ☺ D0824LOH01; 4kW	8EA 737 912-001	Starter 257
				04/92→; -05/96; ☺ D0824LOH01; 4kW	8EA 738 029-001	Starter 257
NM 182, NM 192	130 - 140 kW		05/90→03/97	☺ D0826TOH; 4kW	8EA 726 219-001	Starter 256
				☺ D0826LOH01; 4kW	8EA 726 219-001	Starter 256
				☺ D0826TOH; 4kW	8EA 738 029-001	Starter 257
				☺ D0826LOH01; 4kW	8EA 738 029-001	Starter 257
NM 222, NM 223	162 kW		02/96→	02/96→; -07/98; ☺ D0826LOH15; 5.4kW	8EA 726 022-001	Starter 255
				02/96→; -09/01; ☺ D0826LUH12; 5.4kW	8EA 726 022-001	Starter 255
				02/96→; -07/98; ☺ D0826LOH15; 4kW	8EA 726 038-001	Starter 256

Manufacturer - Model	Power	Displ.	Year of Constr.	Remark	Part Number	Page
MAN - NM						08/87→
NM 222, NM 223	162 kW		02/96→	07/98→; →09/99; ☺ D0826LUH12; 4kW	8EA 726 038-001	Starter 256
				02/96→; →07/98; ☺ D0826LOH15; 4kW	8EA 726 219-001	Starter 256
				02/96→; →01/00; ☺ D0826LUH12; 4kW	8EA 726 219-001	Starter 256
				02/00→; ☺ D0826LOH15; 4kW	8EA 737 912-001	Starter 257
				02/00→; →09/01; ☺ D0826LUH12; 4kW	8EA 737 912-001	Starter 257
				10/99→; →09/01; ☺ D0826LUH12; 4kW	8EA 738 029-001	Starter 257
				02/96→; →07/98; ☺ D0826LOH15; 4kW	8EA 738 029-001	Starter 257
NM 223	162 kW		08/87→	☺ D0826LOH15; 5.4kW	8EA 726 022-001	Starter 255
				☺ D0826LOH15; 4kW	8EA 726 038-001	Starter 256
				☺ D0826LOH15; 4kW	8EA 737 912-001	Starter 257
				☺ D0826LOH15; 4kW	8EA 738 029-001	Starter 257
MAN - NÜ						09/96→
NÜ 263	191 kW		09/96→07/98	☺ D2865LUH09; 5.4kW	8EA 726 022-001	Starter 255
				☺ D2865LUH09; 6kW	8EA 726 025-001	Starter 255
NÜ 263	191 kW		07/98→	07/98→; →09/01; ☺ D0826LUH13; 5.4kW	8EA 726 022-001	Starter 255
				07/98→; →09/01; ☺ D2866LUH22; 5.4kW	8EA 726 022-001	Starter 255
				07/98→; →09/01; ☺ D2866LUH22; 6kW	8EA 726 025-001	Starter 255
NÜ 313	228 kW		07/98→	07/98→; →12/01; ☺ D2866LUH26; 5.4kW	8EA 726 022-001	Starter 255
				07/98→; →12/01; ☺ D2866LUH26; 6kW	8EA 726 025-001	Starter 255
NÜ 313 15M	228 kW		07/98→	07/98→; →06/01; ☺ D2866LUH26; 5.4kW	8EA 726 022-001	Starter 255
				07/98→; →06/01; ☺ D2866LUH26; 6kW	8EA 726 025-001	Starter 255
NÜ 353 15M	257 kW		07/98→	07/98→; →12/01; ☺ D2866LUH21; 5.4kW	8EA 726 022-001	Starter 255
				07/98→; →12/01; ☺ D2866LUH21; 6kW	8EA 726 025-001	Starter 255
MAN - R						05/85→01/93
FRH 362	265 - 274 kW		05/85→12/92	☺ D2866KUJH; 6kW	8EA 726 025-001	Starter 255
R 292, FR 292, FRH 292	213 - 229 kW		05/85→01/93	☺ D2866TUH; 6kW	8EA 726 025-001	Starter 255
				☺ D2866TOH; 6kW	8EA 726 025-001	Starter 255
MAN - SD						04/74→04/94
SD 200	128 kW		10/75→04/80	☺ D2566MUH/175; 6kW	8EA 726 025-001	Starter 255
SD 200	129 kW		04/74→09/75	☺ D2566MXUH/175; 6kW	8EA 726 025-001	Starter 255
SD 200	141 kW		04/74→09/75	☺ D2566MXUH/192; 6kW	8EA 726 025-001	Starter 255
SD 200	141 - 147 kW		10/75→11/86	05/80→; →11/86; ☺ D2566MUH/200; 6kW	8EA 726 025-001	Starter 255
				☺ D2566MUH/192; 6kW	8EA 726 025-001	Starter 255
SD 200	162 kW		06/79→12/86	☺ D2566MUH/220; 6kW	8EA 726 025-001	Starter 255
SD 202	155 kW		10/85→04/94	☺ D2566UH; 6kW	8EA 726 025-001	Starter 255
MAN - SG						07/76→06/97
SG 220	147 kW		05/80→01/85	☺ D2566MUM; 6kW	8EA 726 025-001	Starter 255
SG 220	162 kW		07/76→04/80			
SG 220,SG 240 HÜ,SG 242 H	177 kW		05/80→01/86	☺ D2566MUH; 6kW	8EA 726 025-001	Starter 255
SG 240 H,SG 242,SG 242 H	177 - 180 kW		09/85→04/94	☺ D2866UH; 6kW	8EA 726 025-001	Starter 255
SG 240 H,SG 292 H	213 kW		11/84→09/89	☺ D2866TUH; 6kW	8EA 726 025-001	Starter 255
SG 240 HÜ	206 kW		09/81→01/86	☺ D2566MTUH; 6kW	8EA 726 025-001	Starter 255
SG 242,SG 292	224 - 229 kW		09/85→04/94	04/92→; →04/93; ☺ D2866TOH; 5.4kW	8EA 726 022-001	Starter 255
				☺ D2866TUH; 6kW	8EA 726 025-001	Starter 255
				☺ D2866TOH; 6kW	8EA 726 025-001	Starter 255
SG 312,SG 322	228 - 235 kW		02/94→06/97	02/96→; →06/97; ☺ D2865LUH07; 5.4kW	8EA 726 022-001	Starter 255
				04/94→; →06/97; ☺ D2865LUH08; 5.4kW	8EA 726 022-001	Starter 255
				☺ D2865LUH07; 5.4kW	8EA 726 022-001	Starter 255
				☺ D2865LUH08; 5.4kW	8EA 726 022-001	Starter 255
				☺ D2865LUH08; 6kW	8EA 726 025-001	Starter 255
				☺ D2865LUH07; 6kW	8EA 726 025-001	Starter 255
				02/96→; →06/97; ☺ D2865LUH07; 6kW	8EA 726 025-001	Starter 255
				04/94→; →06/97; ☺ D2865LUH08; 6kW	8EA 726 025-001	Starter 255
MAN - SL						05/80→04/87
SL 200	147 - 150 kW		05/80→04/87	☺ D2566MUH; 6kW	8EA 726 025-001	Starter 255
				☺ D2566UH; 6kW	8EA 726 025-001	Starter 255
SL 200	177 kW		05/80→01/86	☺ D2566MUH; 6kW	8EA 726 025-001	Starter 255
SL 200	177 kW		01/86→04/87	☺ D2866UH; 6kW	8EA 726 025-001	Starter 255
MAN - SL II						06/84→04/94
SL 202	147 - 155 kW		06/84→04/93	☺ D2566UH; 6kW	8EA 726 025-001	Starter 255
SL 202	177 - 180 kW		06/84→04/94	☺ D2866UH; 6kW	8EA 726 025-001	Starter 255

Manufacturer - Model	Power	Displ.	Year of Constr.	Remark	Part Number	Page
MAN - SM					11/87→02/95	
SM 152	110 - 114 kW		11/87→04/94	☺ D0826OH02; 4kW ☺ D0826OH02; 4kW	8EA 726 038-001 8EA 726 219-001	Starter 256 Starter 256
SM 182, SM 192	130 - 140 kW		11/87→02/95	☺ D0826TOH; 5.4kW ☺ D0826LOH01; 5.4kW ☺ D0826TOH; 4kW ☺ D0826LOH01; 4kW ☺ D0826TOH; 4kW ☺ D0826LOH01; 4kW	8EA 726 022-001 8EA 726 022-001 8EA 726 038-001 8EA 726 038-001 8EA 726 219-001 8EA 726 219-001	Starter 255 Starter 255 Starter 256 Starter 256 Starter 256 Starter 256
MAN - SR					10/75→11/86	
SR 240	177 kW		10/75→06/83	☺ D2566MUH/240; 6kW	8EA 726 025-001	Starter 255
SR 280, SR 280 H	206 kW		01/77→11/86	☺ D2566MTUH; 6kW	8EA 726 025-001	Starter 255
SR 321 H	235 kW		03/82→11/86	☺ D2566MKUH; 6kW	8EA 726 025-001	Starter 255
MAN - SÜ					10/75→	
SÜ 240	147 - 150 kW		05/80→09/89	01/86→; →09/89; ☺ D2566UH; 6kW 05/80→; →11/83; ☺ D2566MUH; 6kW	8EA 726 025-001 8EA 726 025-001	Starter 255 Starter 255
SÜ 240	177 kW		10/75→01/86	☺ D2566MUH; 6kW	8EA 726 025-001	Starter 255
SÜ 240	177 kW		01/86→09/89	☺ D2866UH; 6kW	8EA 726 025-001	Starter 255
SÜ 242	177 - 180 kW		01/87→04/93			
SÜ 240	206 kW		11/82→01/86	☺ D2566MTUH; 6kW	8EA 726 025-001	Starter 255
SÜ 240	213 kW		01/86→09/89	☺ D2866TOH; 6kW	8EA 726 025-001	Starter 255
SÜ 263	265 kW		09/03→	☺ D2866LUH25; 5.4kW ☺ D2866LUH25; 6kW	8EA 726 022-001 8EA 726 025-001	Starter 255 Starter 255
SÜ 272	198 kW		04/93→05/95	☺ D2865LUH02; 5.4kW ☺ D2865LUH02; 6kW	8EA 726 022-001 8EA 726 025-001	Starter 255 Starter 255
SÜ 283	206 kW		09/03→	06/04→; ☺ D0836LOH02; 5.4kW ☺ D0836LOH02; 4kW 06/04→; ☺ D0836LOH02; 4kW	8EA 726 022-001 8EA 737 912-001 8EA 738 029-001	Starter 255 Starter 257 Starter 257
SÜ 292	229 kW		04/92→04/93	☺ D2866TOH; 5.4kW	8EA 726 022-001	Starter 255
SÜ 313	228 kW		09/03→	06/04→; →09/06; ☺ D2866LUH24; 5.4kW 06/04→; →09/06; ☺ D2866LUH24; 6kW	8EA 726 022-001 8EA 726 025-001	Starter 255 Starter 255
SÜ 322	235 kW		05/95→06/97	☺ D2865LUH08; 5.4kW ☺ D2865LUH08; 6kW	8EA 726 022-001 8EA 726 025-001	Starter 255 Starter 255
MAN - TGA					04/00→	
18.310, 18.320 FAK, FAK-L, FALK, FALK-L, FHLK, FHLK/M	228 - 235 kW		05/04→	☺ D2066LF04; 5.4kW ☺ D2066LF35; 5.4kW	8EA 726 022-001 8EA 726 022-001	Starter 255 Starter 255
18.310, 18.320 FC, FLC, FLLC, FLLC/N, FLLW, FLLW/N	228 - 235 kW		05/04→	☺ D2066LF14; 5.4kW ☺ D2066LF28; 5.4kW ☺ D2066LF04; 5.4kW ☺ D2066LF35; 5.4kW ☺ D2066LF39; 5.4kW	8EA 726 022-001 8EA 726 022-001 8EA 726 022-001 8EA 726 022-001 8EA 726 022-001	Starter 255 Starter 255 Starter 255 Starter 255 Starter 255
18.310, 18.320 FK, FK-L, FLK, FLK/M	228 - 235 kW		05/04→	☺ D2066LF14; 5.4kW ☺ D2066LF04; 5.4kW ☺ D2066LF35; 5.4kW	8EA 726 022-001 8EA 726 022-001 8EA 726 022-001	Starter 255 Starter 255 Starter 255
18.310, 18320 FC, FLC, FRC, FLLC, FLLC/N, FLLW, FLLRC, FLLRW	228 - 235 kW		04/00→	04/00→; →08/02; ☺ D2866LF26; 5.4kW 04/00→; →09/01; ☺ D2866LF36; 5.4kW	8EA 726 022-001 8EA 726 022-001	Starter 255 Starter 255
18.310 FLS, FLLS, FLLS/N, FLS-TS, FLRS, FLLRS	228 kW		04/00→			
18.310, 18320 FK, FLK, FK-L, FLRK	228 - 235 kW		12/00→	12/00→; →09/01; ☺ D2866LF36; 5.4kW 12/00→; →05/04; ☺ D2866LF26; 5.4kW	8EA 726 022-001 8EA 726 022-001	Starter 255 Starter 255
26.310 FVL-KO	228 kW		12/00→			
18.310 FAC, FARC	228 kW		09/02→			
18.310 FAK, FAK-L, FALK	228 kW		09/02→			
18.310 FAS, FARS	228 kW		09/02→			
18.350, 18.360 FAS, FALS, FHLS, FHLS/M	257 - 265 kW		05/04→	☺ D2066LF13; 5.4kW ☺ D2066LF03; 5.4kW ☺ D2066LF33; 5.4kW	8EA 726 022-001 8EA 726 022-001 8EA 726 022-001	Starter 255 Starter 255 Starter 255
18.350, 18.360 FC, FLC, FLLC, FLLRC, FLLC/N, FLLW, FLLW/N	257 - 265 kW		05/04→	☺ D2066LF03; 5.4kW ☺ D2066LF33; 5.4kW	8EA 726 022-001 8EA 726 022-001	Starter 255 Starter 255
18.350, 18.360 FK, FK-L, FLK, FLK/M,	257 - 265 kW		05/04→			
18.360 FAC, FARC	265 kW		09/02→			
18.360 FAK, FALK, FAK-L, FALK-L	265 kW		09/02→			
18.360 FAS, FALS, FARS	265 kW		09/02→			
18.360 FC, FLC, FRC, FLLC, FLLC/N, FLLW, FLLRW	265 kW		04/00→	04/00→; →03/04; ☺ D2866LF37; 5.4kW 04/00→; →03/04; ☺ D2866LF27; 5.4kW	8EA 726 022-001 8EA 726 022-001	Starter 255 Starter 255

Manufacturer - Model	Power	Displ.	Year of Constr.	Remark	Part Number	Page
MAN - TGA						04/00→
18.360 FK, FLK, FK-L, FLRK	265 kW		12/00→	12/00→; -03/04; ☺ D2866LF37; 5.4kW	8EA 726 022-001	Starter 255
				12/00→; -03/04; ☺ D2866LF27; 5.4kW	8EA 726 022-001	Starter 255
18.360 FLS, FLLS, FLLS/N, FLS-TS, FLRS, FLLRS	265 kW		04/00→	☺ D2866LF37; 5.4kW	8EA 726 022-001	Starter 255
				04/00→; -03/04; ☺ D2866LF27; 5.4kW	8EA 726 022-001	Starter 255
18.410, 18420 FAK, FAK-L, FALK	301 - 309 kW		09/02→	09/02→; -12/05; ☺ D2866LF28; 5.4kW	8EA 726 022-001	Starter 255
18.410 FAC, FARC	301 kW		09/02→			
18.410 FAS, FALS, FARS	301 kW		09/02→			
26.410 FDAC, FDARC	301 kW		02/02→			
26.410 FDAS, FDALS, FDARS	301 kW		02/02→			
26.410 FDC, FDLC, FDLC/M, FDLC-WW; FDRC-WW, FDLRC-WW	301 kW		01/01→			
26.410 FDK, FDRK, FDLK, FDLRK	301 kW		09/01→			
26.410 FDS, FDLS, FDLS/M, FDLS-WW, FDRS-WW, FDLRS-WW	301 kW		06/01→			
18.410, 18420 FC, FRC, FLC, FLRC, FLLC, FLLC/N, FLLW, FLLRC	301 - 309 kW		04/00→	09/02→; -12/05; ☺ D2866LF28; 5.4kW	8EA 726 022-001	Starter 255
				04/00→; -03/04; ☺ D2866LF32; 5.4kW	8EA 726 022-001	Starter 255
18.410, 18420 FK, FK-L, FLK, FLRK	301 - 309 kW		12/00→	12/00→; -03/04; ☺ D2866LF28; 5.4kW	8EA 726 022-001	Starter 255
				12/00→; -03/04; ☺ D2866LF32; 5.4kW	8EA 726 022-001	Starter 255
18.410 FLS, FLLS, FLLS/N, FLS-TS, FLRS, FLLRS	301 kW		04/00→	04/00→; -12/05; ☺ D2866LF28; 5.4kW	8EA 726 022-001	Starter 255
				04/00→; -03/04; ☺ D2866LF32; 5.4kW	8EA 726 022-001	Starter 255
18.460 FC, FLC, FRC, FLLC, FLLC/N, FLLW, FLLRC, FLLRW	338 kW		04/00→	04/00→; -05/04; ☺ D2876LF04; 5.4kW	8EA 726 022-001	Starter 255
18.460 FLS, FLLS, FLLS/N, FLS-TS, FLRS, FLLRS	338 kW		04/00→	04/00→; -05/04; ☺ D2876LF07; 5.4kW	8EA 726 022-001	Starter 255
18.460 FK, FK-L, FLK, FLRK	338 kW		12/00→	12/00→; -05/04; ☺ D2876LF04; 5.4kW	8EA 726 022-001	Starter 255
				12/00→; -05/04; ☺ D2876LF07; 5.4kW	8EA 726 022-001	Starter 255
18.480 FAC, FARC	353 kW		09/02→	10/02→; ☺ D2876LF12; 5.4kW	8EA 726 022-001	Starter 255
18.480 FAK, FAK-L, FALK	353 kW		09/02→			
18.480 FC, FLC, FLLC, FLLW, FLLRW, FLLRC	353 kW		09/02→			
18.480 FK, FLK, FK-L	353 kW		09/02→			
18.480 FLS, FLLS, FLLS/N, FLS-TS, FLRS-WW	353 kW		09/02→			
33.480 FDAC, FDAC-WW, FDALC, FDARC	353 kW		09/02→			
18.510 FC, FLC, FRC, FLLC, FLLC/N, FLLW, FLLRC, FLLRW	375 kW		09/00→	☺ D2876LF05; 5.4kW	8EA 726 022-001	Starter 255
18.510 FLS, FLLS, FLLS/N, FLRS, FLLRS	375 kW		04/00→			
28.510 FNLC, FNLLC, FNLRC	375 kW		09/02→			
28.510 FNLS, FNLRS	375 kW		09/02→			
33.510 FDC, FDC/M, FDLC, FDRC, FDLRC	375 kW		09/02→			
18.530 FC, FLC, FLLC, FLLC/N, FLLW, FLLRC, FLLRW	390 kW		09/02→	10/02→; ☺ D2876LF13; 5.4kW	8EA 726 022-001	Starter 255
26.530 FDC, FDLC, FDC/M, FDLRC	390 kW		01/01→			
26.530 FDK, FDLK, FDLRK	390 kW		09/02→			
26.530 FDS, FDLS, FDLS/M, FDLRS	390 kW		01/01→			
26.530 FNLC, FNLLC, FNLLW, FNLLRC, FVLC, FVLRC	390 kW		09/02→			
26.530 FNLS, FNLLS, FNLRS, FPLS, FVLS, FVLRS	390 kW		09/02→			
33.530 FDAS, FDALS	390 kW		09/02→			
33.530 FDC, FDC/M, FDLC, FDRC, FDLRC	390 kW		09/02→			
18.530 FLS, FLLS, FLLS/N	390 kW		09/02→	☺ D2876LF13; 5.4kW	8EA 726 022-001	Starter 255
26.530 FDAC, FDALC	390 kW		07/06→			
26.530 FDAK, FDALK	390 kW		09/02→			
26.530 FDAS, FDALS	390 kW		07/06→			
28.530 FANLC	390 kW		07/06→			
28.530 FANLK	390 kW		07/06→			
28.530 FNLC, FNLLC, FNLRC	390 kW		09/02→			
28.530 FNLS, FNLRS	390 kW		09/02→			
33.530 FDAC, FDALC	390 kW		09/02→			
33.530 FDAK, FDALK	390 kW		09/02→			
33.530 FDK, FDLK	390 kW		07/03→			
33.530 FDS, FDLS, FDLS/M, FDRS, FDLRS	390 kW		07/03→			
35.530 FFDK	390 kW		07/06→			
41.530 FFDK	390 kW		07/06→			
41.530 FFDK	390 kW		12/04→			

Manufacturer - Model	Power	Displ.	Year of Constr.	Remark	Part Number	Page
MAN - TGA						04/00→
41.530 FFD-TM	390 kW		12/04→	☺ D2876LF13; 5.4kW	8EA 726 022-001	Starter 255
19.360 FS/M-WW, FRS/M-WW	265 kW		05/04→	☺ D2866LF37; 5.4kW	8EA 726 022-001	Starter 255
41.360 FFDK-WW	265 kW		09/03→			
19.410 FS/M-WW, FRS/M-WW	301 kW		05/04→	☺ D2866LF32; 5.4kW	8EA 726 022-001	Starter 255
19.460 FS/M-WW, FRS/M-WW	338 kW		05/04→	☺ D2876LF07; 5.4kW	8EA 726 022-001	Starter 255
33.460 FDAC-WW	338 kW		09/02→			
33.460 FDAK-WW	338 kW		09/02→			
33.460 FDAS-WW	338 kW		09/02→			
40.460 FDAK-WW	338 kW		04/04→			
40.460 FDAS-WW	338 kW		04/04→			
41.460 FFDC-WW, FFDR	338 kW		09/03→			
41.460 FFDK-WW	338 kW		09/03→			
19.480 FS/M-WW, FRS/M-WW	353 kW		05/04→	☺ D2876LF25; 5.4kW	8EA 726 022-001	Starter 255
24.360 FNLLC/N, FNLLW, FNLLRW, FNLLRC	265 kW		09/01→	11/02→; →05/04; ☺ D2866LF27; 5.4kW	8EA 726 022-001	Starter 255
24.410 FNLLC/N, FNLLW, FNLLRW	301 kW		09/01→	11/02→; →05/04; ☺ D2866LF28; 5.4kW	8EA 726 022-001	Starter 255
24.460 FNLLC/N, FNLLW, FNLLRC, FNLLRW	338 kW		09/01→	11/02→; →05/04; ☺ D2876LF04; 5.4kW	8EA 726 022-001	Starter 255
24.480 FNLLC/N, FNLLW, FNLLRC, FNLLRW	353 kW		09/02→	06/03→; →09/06; ☺ D2876LF12; 5.4kW	8EA 726 022-001	Starter 255
26.480 FDC, FDLC, FDR, FDLC/M, FDLRC-WW	353 kW		09/02→			
26.480 FDS, FDLS, FDLS/M, FDLRS-WW, FDRS	353 kW		09/02→			
26.480 FNLS, FNLLS, FNLR, FPLS, FVLS	353 kW		09/02→			
26.480 FVL-KO	353 kW		09/02→			
24.510 FNLLC/N, FNLLW, FNLLRW	375 kW		09/01→	11/02→; →06/03; ☺ D2876LF05; 5.4kW	8EA 726 022-001	Starter 255
24.530 FNLLC/N, FNLLW, FNLLRW	390 kW		09/01→	12/02→; →09/06; ☺ D2876LF13; 5.4kW	8EA 726 022-001	Starter 255
26.310 FDAC, FDARC	228 kW		02/02→	10/02→; →05/04; ☺ D2866LF26; 5.4kW	8EA 726 022-001	Starter 255
26.310 FDAK	228 kW		02/02→			
26.310 FDAS, FDARS	228 kW		02/02→			
26.310 FDC, FDLC, FDR, FDLC/M, FDLRC	228 kW		01/01→			
26.310 FDK, FDLK, FDRK	228 kW		09/02→			
26.310 FDS, FDLS, FDLS/M, FDLRS	228 kW		01/01→			
26.310 FD-TM, FDR-TM	228 kW		10/00→			
26.310 FNLC, FNLLC, FVLC, FNLLW, FNLR, FNLLRW	228 kW		09/00→	09/00→; →09/01; ☺ D2866LF36; 5.4kW	8EA 726 022-001	Starter 255
				09/00→; →05/04; ☺ D2866LF26; 5.4kW	8EA 726 022-001	Starter 255
26.310 FPLS, FVLS, FNLS, FNLLS, FPLRS, FNLR, FVLR	228 kW		12/00→	12/00→; →05/04; ☺ D2866LF26; 5.4kW	8EA 726 022-001	Starter 255
26.360 FDAC, FDARC	265 kW		02/02→	09/02→; →12/05; ☺ D2866LF27; 5.4kW	8EA 726 022-001	Starter 255
26.360 FDAS, FDARS	265 kW		02/02→			
26.360 FDK, FDLK, FDRK, FDLRK	265 kW		09/02→			
26.360 FD-TM, FDR-TM	265 kW		01/01→			
26.360 FDAK, FDALK	265 kW		02/02→	02/02→; →12/05; ☺ D2866LF27; 5.4kW	8EA 726 022-001	Starter 255
26.360 FDC, FDLC, FDLC/M, FDR, FDLRC-WW	265 kW		01/01→	01/01→; →12/05; ☺ D2866LF27; 5.4kW	8EA 726 022-001	Starter 255
26.360 FDLS, FDLS/M, FDLRS, FDLRS/M, FDLRS-WW, FDRS	265 kW		09/03→	☺ D2866LF27; 5.4kW	8EA 726 022-001	Starter 255
28.360 FANLC	265 kW		07/06→			
28.360 FANLK	265 kW		07/06→			
28.360 FNLC, FNLLC	265 kW		09/02→			
28.360 FNLS, FNLR	265 kW		09/02→			
33.360 FD-TM, FDR-TM	265 kW		01/01→			
26.360 FDS, FDLS, FNLS, FNLLS, FPLS, FPLRS, FVLS, FVLR	265 kW		12/00→	12/00→; →12/05; ☺ D2866LF27; 5.4kW	8EA 726 022-001	Starter 255
26.360 FNLC, FNLLC, FNLLW, FNLLRC, FNLLRW, FVLC	265 kW		09/00→	09/00→; →12/05; ☺ D2866LF27; 5.4kW	8EA 726 022-001	Starter 255
				09/00→; →09/01; ☺ D2866LF37; 5.4kW	8EA 726 022-001	Starter 255
26.360 FVL-KO	265 kW		12/00→	12/00→; →12/05; ☺ D2866LF27; 5.4kW	8EA 726 022-001	Starter 255
				12/00→; →09/01; ☺ D2866LF37; 5.4kW	8EA 726 022-001	Starter 255
26.410 FD-TM, FDR-TM	301 kW		01/01→	09/02→; ☺ D2866LF28; 5.4kW	8EA 726 022-001	Starter 255
26.410 FNLC, FNLLC, FNLLW, FNLR, FNLLRC, FVLC	301 kW		04/00→	04/00→; →12/05; ☺ D2866LF28; 5.4kW	8EA 726 022-001	Starter 255
				04/00→; →09/01; ☺ D2866LF32; 5.4kW	8EA 726 022-001	Starter 255
26.410 FPLS, FPLRS, FVLS, FNLS, FNLLS	301 kW		12/00→	12/00→; →12/05; ☺ D2866LF28; 5.4kW	8EA 726 022-001	Starter 255
26.410 FVL-KO	301 kW		12/00→	12/00→; →09/01; ☺ D2866LF32; 5.4kW	8EA 726 022-001	Starter 255
				12/00→; →12/05; ☺ D2866LF28; 5.4kW	8EA 726 022-001	Starter 255

Manufacturer - Model	Power	Displ.	Year of Constr.	Remark	Part Number	Page
MAN - TGA						04/00→
26.410 FVLS, FVLR	301 kW		07/05→	☺ D2866LF32; 5.4kW	8EA 726 022-001	Starter 255
33.410 FDC, FDC-WW, FDLC, FDLRC, FDRC-WW	301 kW		10/00→	☺ D2866LF28; 5.4kW	8EA 726 022-001	Starter 255
33.410 FDS, FDS-WW, FDLS, FDLS/M, FDLRS, FDRS-WW	301 kW		10/00→			
40.410 FDAK-WW	301 kW		04/04→			
40.410 FDAS-WW	301 kW		04/04→			
41.410 FFDC-WW, FDRC	301 kW		09/03→			
41.410 FFDK-WW	301 kW		09/03→			
26.460 FDC, FDLC, FDLC/M, FDLC-WW, FDRC, FDLRC-WW	338 kW		01/01→	09/02→; →06/05; ☺ D2876LF04; 5.4kW	8EA 726 022-001	Starter 255
26.460 FDK, FDLK, FDLRK	338 kW		01/01→			
26.460 FDS, FDLS, FDLS/M, FDLS-WW, FDRS-WW, FDLRS-WW	338 kW		06/01→	06/01→; →09/01; ☺ D2876LF07; 5.4kW	8EA 726 022-001	Starter 255
26.460 FD-TM, FDR-TM	338 kW		01/01→	01/01→; →09/01; ☺ D2876LF07; 5.4kW	8EA 726 022-001	Starter 255
26.460 FNLC, FNLRC, FNLLC, FNLLRW, FNLLRC	338 kW		04/00→	04/00→; →06/05; ☺ D2876LF04; 5.4kW	8EA 726 022-001	Starter 255
				04/00→; →09/01; ☺ D2876LF07; 5.4kW	8EA 726 022-001	Starter 255
26.460 FPLS, FPLRS, FVLS, FVLR, FNLS, FNLLS, FNLR	338 kW		12/00→	12/00→; →06/05; ☺ D2876LF04; 5.4kW	8EA 726 022-001	Starter 255
26.460 FVLC	338 kW		02/01→	09/02→; →06/05; ☺ D2876LF04; 5.4kW	8EA 726 022-001	Starter 255
				09/02→; ☺ D2876LF07; 5.4kW	8EA 726 022-001	Starter 255
26.460 FVL-KO	338 kW		12/00→	12/00→; →06/05; ☺ D2876LF04; 5.4kW	8EA 726 022-001	Starter 255
				12/00→; →09/01; ☺ D2876LF07; 5.4kW	8EA 726 022-001	Starter 255
26.480 FDAC, FDALC, FDARC	353 kW		09/02→	08/03→; →09/06; ☺ D2876LF12; 5.4kW	8EA 726 022-001	Starter 255
26.480 FDAK, FDALK	353 kW		09/02→	09/02→; →09/06; ☺ D2876LF12; 5.4kW	8EA 726 022-001	Starter 255
26.480 FDAS, FDALS, FDARS	353 kW		09/02→			
26.480 FDK, FDLK	353 kW		02/06→	☺ D2876LF01; 5.4kW	8EA 726 022-001	Starter 255
26.480 FDS, FDLS, FDLRS, FNHLS, FPHLS, FVHLS	353 kW		02/06→			
26.480 FNLC, FNLRC-WW, FNLLC, FNLLRC, FNLLW, FVLC	353 kW		02/06→			
26.480 FNLS, FNLLS, FNLR, FPLS, FVLS, FVLR	353 kW		02/06→			
26.480 FDK, FDLK, FDLRK	353 kW		09/02→	05/03→; →09/06; ☺ D2876LF12; 5.4kW	8EA 726 022-001	Starter 255
26.480 FD-TM	353 kW		09/02→			
26.480 FNLC, FNLLC, FVLC, FNLLRC, FVLLW	353 kW		09/02→			
26.510 FDC, FDC/M, FDRC, FDLC, FDLC/M, FDLRC	375 kW		01/01→	09/02→; →06/03; ☺ D2876LF05; 5.4kW	8EA 726 022-001	Starter 255
26.510 FDS, FDLS, FDLS/M, FDRS, FDLRS	375 kW		01/01→			
33.510 FDS, FDLS/M, FDRS, FDLRS/M	375 kW		09/02→			
26.510 FNLC, FNLLC, FNLLW, FNLLRC, FVLC	375 kW		12/00→	12/00→; →06/03; ☺ D2876LF05; 5.4kW	8EA 726 022-001	Starter 255
26.510 FNLS, FNLLS, FNLR, FPLS, FVLS	375 kW		12/00→			
28.310 FNLC, FNLLC	228 kW		09/02→	☺ D2866LF26; 5.4kW	8EA 726 022-001	Starter 255
28.310 FNLC, FNLLC, FNLRC	228 kW		09/02→			
28.310 FNLS, FNLR	228 kW		09/02→			
32.310 FFDC, FFDLC, FFDLRC	228 kW		01/02→			
32.310 FFDK, FFDLK	228 kW		01/02→			
32.310 FFD-TM	228 kW		01/02→			
35.310 FFD-TM	228 kW		11/03→			
28.390 FNLLC	353 kW		07/06→	☺ D2876LF12; 5.4kW	8EA 726 022-001	Starter 255
28.480 FANLK	353 kW		07/06→			
28.480 FNLC, FNLLC, FNLRC	353 kW		09/02→			
28.480 FNLS, FNLR	353 kW		09/02→			
33.480 FDAK, FDAK-WW, FDALK	353 kW		09/02→			
33.480 FD-TM	353 kW		09/02→			
35.480 FFDK	353 kW		07/06→			
41.480 FFDK	353 kW		07/06→			
41.480 FFDC-WW, FFDRC	353 kW		06/05→			
41.480 FFDK-WW	353 kW		06/05→			
41.530 FFDK	353 kW		07/06→			
28.410 FANLC	301 kW		07/06→	☺ D2866LF28; 5.4kW	8EA 726 022-001	Starter 255
28.410 FANLK	301 kW		07/06→			
28.410 FNLC, FNLLC	301 kW		09/02→			
28.410 FNLC, FNLLC, FNLRC	301 kW		09/02→			
28.410 FNLS, FNLR	301 kW		09/02→			
33.410 FDAC, FDAC-WW, FDALC	301 kW		09/02→			
33.410 FDAK, FDAK-WW, FDALK	301 kW		09/02→			

Manufacturer - Model	Power	Displ.	Year of Constr.	Remark	Part Number	Page
MAN - TGA						04/00→
33.410 FDAS, FDAS-WW, FDALS	301 kW		09/02→	☼ D2866LF28; 5.4kW	8EA 726 022-001	Starter 255
33.410 FD-TM, FDR-TM	301 kW		10/00→			
35.410 FFDK	301 kW		07/06→			
37.410 FFDC	301 kW		12/04→			
37.410 FFDK	301 kW		12/04→			
37.410 FFD-TM	301 kW		12/04→			
41.410 FFDK	301 kW		07/06→			
41.410 FFD-TM	301 kW		12/04→			
28.460 FNLC, FNLLC, FNLRC	338 kW		09/02→	☼ D2876LF04; 5.4kW	8EA 726 022-001	Starter 255
28.460 FNLS, FNLRS	338 kW		09/02→			
33.460 FD-TM, FDR-TM	338 kW		09/02→			
35.460 FFNLC	338 kW		07/06→			
37.460 FFDC	338 kW		12/04→			
37.460 FFDK	338 kW		12/04→			
37.460 FFD-TM	338 kW		12/04→			
41.460 FFD-TM	338 kW		12/04→			
32.360 FFDC, FFDLC, FFDLRC	265 kW		01/02→	09/02→; ☼ D2866LF27; 5.4kW	8EA 726 022-001	Starter 255
32.360 FFDK, FFDLK	265 kW		01/02→			
32.360 FFD-TM	265 kW		01/02→			
32.410 FFDK, FFDLK	301 kW		01/02→	09/02→; -06/05; ☼ D2866LF28; 5.4kW	8EA 726 022-001	Starter 255
32.410 FFD-TM	301 kW		01/02→			
32.460 FFDC, FFDLC, FFDLRC	338 kW		01/02→	09/02→; ☼ D2876LF04; 5.4kW	8EA 726 022-001	Starter 255
32.460 FFDK, FFDLK	338 kW		01/02→			
32.460 FFD-TM	338 kW		01/02→			
32.480 FFDC, FFDLC, FFDLRC	353 kW		09/02→	05/04→; -09/05; ☼ D2876LF12; 5.4kW	8EA 726 022-001	Starter 255
32.480 FFDK, FFDLK	353 kW		09/02→			
32.480 FFD-TM	353 kW		09/02→			
33.360 FDAC, FDARC, FDAC-WW	265 kW		09/02→	09/02→; -05/04; ☼ D2866LF37; 5.4kW	8EA 726 022-001	Starter 255
33.360 FDAK, FDAK-WW	265 kW		09/02→	09/02→; -05/04; ☼ D2866LF27; 5.4kW	8EA 726 022-001	Starter 255
33.360 FDAS, FDAS-WW	265 kW		09/02→	☼ D2866LF37; 5.4kW	8EA 726 022-001	Starter 255
33.360 FDK, FDK-WW, FDLK, FDRK-WW	265 kW		01/01→	☼ D2866LF27; 5.4kW	8EA 726 022-001	Starter 255
33.360 FDC, FDC-WW, FDLK/M, FDRK-WW, FDLRC	265 kW		10/00→	09/02→; ☼ D2866LF27; 5.4kW	8EA 726 022-001	Starter 255
				☼ D2866LF37; 5.4kW	8EA 726 022-001	Starter 255
33.360 FDS, FDS-WW, FDLK, FDLRS, FDRS-WW	265 kW		10/00→	09/02→; -12/05; ☼ D2866LF27; 5.4kW	8EA 726 022-001	Starter 255
				09/02→; -12/05; ☼ D2866LF37; 5.4kW	8EA 726 022-001	Starter 255
33.410 FDK, FDK-WW, FDLK, FDRK-WW	301 kW		10/00→	10/00→; -12/05; ☼ D2866LF28; 5.4kW	8EA 726 022-001	Starter 255
				☼ D2866LF32; 5.4kW	8EA 726 022-001	Starter 255
33.460 FDC, FDC-WW, FDLK, FDLRC, FDRK-WW	338 kW		09/02→	09/02→; -12/05; ☼ D2876LF04; 5.4kW	8EA 726 022-001	Starter 255
33.460 FDK, FDK-WW, FDLK, FDRK-WW	338 kW		09/02→	01/06→; ☼ D2876LF07; 5.4kW	8EA 726 022-001	Starter 255
33.460 FDS, FDLK, FDLRS, FDRS-WW	338 kW		09/02→			
33.480 FDAS, FDAS-WW, FDARS, FDALS	353 kW		09/02→	08/03→; ☼ D2876LF12; 5.4kW	8EA 726 022-001	Starter 255
33.480 FDC, FDC-WW, FDLK, FDRK-WW, FDLRC	353 kW		09/02→	☼ D2876LF25; 5.4kW	8EA 726 022-001	Starter 255
				08/03→; -09/06; ☼ D2876LF12; 5.4kW	8EA 726 022-001	Starter 255
33.480 FDK, FDK-WW, FDLK, FDRK-WW	353 kW		09/02→	☼ D2876LF25; 5.4kW	8EA 726 022-001	Starter 255
				08/03→; ☼ D2876LF12; 5.4kW	8EA 726 022-001	Starter 255
33.480 FDS, FDS-WW, FDLK, FDLRS, FDRS-WW	353 kW		09/02→	☼ D2876LF25; 5.4kW	8EA 726 022-001	Starter 255
				06/03→; ☼ D2876LF12; 5.4kW	8EA 726 022-001	Starter 255
35.310 FFDC, FFDLC	228 kW		06/03→	06/03→; -06/05; ☼ D2866LF26; 5.4kW	8EA 726 022-001	Starter 255
35.310 FFDK, FFDLK	228 kW		06/03→			
35.360 FFDK, FFDLK	265 kW		10/03→	10/03→; -12/05; ☼ D2866LF27; 5.4kW	8EA 726 022-001	Starter 255
35.410 FFDC, FFDLC	301 kW		10/03→	10/03→; -05/04; ☼ D2866LF28; 5.4kW	8EA 726 022-001	Starter 255
35.410 FFDK, FFDLK	301 kW		10/03→			
35.480 FFDC, FFDLC	353 kW		10/03→	10/03→; -09/06; ☼ D2876LF12; 5.4kW	8EA 726 022-001	Starter 255
35.480 FFDK, FFDLK	353 kW		10/03→			
35.530 FFDC, FFDLC	390 kW		04/04→	06/04→; -03/06; ☼ D2876LF13; 5.4kW	8EA 726 022-001	Starter 255
35.530 FFDK, FFDLK	390 kW		04/04→			
40.410 FDK-WW	301 kW		04/04→	04/04→; -12/05; ☼ D2866LF28; 5.4kW	8EA 726 022-001	Starter 255
40.410 FDS-WW	301 kW		04/04→	04/04→; -12/05; ☼ D2866LF32; 5.4kW	8EA 726 022-001	Starter 255
40.460 FDK-WW	338 kW		04/04→	01/06→; ☼ D2876LF07; 5.4kW	8EA 726 022-001	Starter 255
40.460 FDS-WW	338 kW		04/04→			
40.480 FDAK-WW	353 kW		04/04→	☼ D2876LF25; 5.4kW	8EA 726 022-001	Starter 255
40.480 FDAS-WW	353 kW		04/04→	☼ D2876LF12; 5.4kW	8EA 726 022-001	Starter 255
40.480 FDK-WW	353 kW		04/04→	11/04→; -09/06; ☼ D2876LF25; 5.4kW	8EA 726 022-001	Starter 255
				04/04→; -09/06; ☼ D2876LF12; 5.4kW	8EA 726 022-001	Starter 255
40.480 FDS-WW	353 kW		04/04→	11/04→; -09/06; ☼ D2876LF25; 5.4kW	8EA 726 022-001	Starter 255
				11/04→; -09/06; ☼ D2876LF12; 5.4kW	8EA 726 022-001	Starter 255

Manufacturer - Model	Power	Displ.	Year of Constr.	Remark	Part Number	Page
MAN - TGA						04/00→
41.360 FFDC, FFDC/M, FFDC/M- WW, FFDC	265 kW		01/03→	01/03→; -12/05; ⚙️ D2866LF37; 5.4kW	8EA 726 022-001	Starter 255
				01/03→; -12/05; ⚙️ D2866LF27; 5.4kW	8EA 726 022-001	Starter 255
41.530 FVDS, FVDLS	390 kW		09/02→	06/03→; ⚙️ D2876LF13; 5.4kW	8EA 726 022-001	Starter 255
41.660 FVDS, FVDLS	485 kW		09/02→	⚙️ D2840LF25; 6kW	8EA 726 025-001	Starter 255
MAN - ÜL						09/89→
ÜL 242	177 kW		09/89→03/93	⚙️ D2866UH/240; 6kW	8EA 726 025-001	Starter 255
ÜL 272	198 kW		03/93→	03/93→; -07/94; ⚙️ D2865LUH02; 5.4kW	8EA 726 022-001	Starter 255
				07/94→; -09/95; ⚙️ D2865LUH05; 5.4kW	8EA 726 022-001	Starter 255
				03/93→; -07/94; ⚙️ D2865LUH02; 6kW	8EA 726 025-001	Starter 255
ÜL 292	213 - 222 kW		09/89→03/93	⚙️ D2866TUH01; 6kW	8EA 726 025-001	Starter 255
ÜL 312, ÜL 322	228 - 235 kW		04/92→09/96	09/95→; -09/96; ⚙️ D2865LUH07; 5.4kW	8EA 726 022-001	Starter 255
				⚙️ D2865LUH07; 5.4kW	8EA 726 022-001	Starter 255
				⚙️ D2865LUH08; 5.4kW	8EA 726 022-001	Starter 255
				⚙️ D2865LUH07; 6kW	8EA 726 025-001	Starter 255
				09/95→; -09/96; ⚙️ D2865LUH07; 6kW	8EA 726 025-001	Starter 255
ÜL 313	228 kW		09/96→	⚙️ D2865LUH08; 6kW	8EA 726 025-001	Starter 255
				09/96→; -09/01; ⚙️ D2866LUH20; 5.4kW	8EA 726 022-001	Starter 255
				09/96→; -09/01; ⚙️ D2866LUH26; 5.4kW	8EA 726 022-001	Starter 255
				09/96→; -09/01; ⚙️ D2866LUH26; 6kW	8EA 726 025-001	Starter 255
				09/96→; -09/01; ⚙️ D2866LUH20; 6kW	8EA 726 025-001	Starter 255
ÜL 353	257 kW		06/97→	06/97→; -12/01; ⚙️ D2866LUH21; 5.4kW	8EA 726 022-001	Starter 255
				06/97→; -12/01; ⚙️ D2866LUH21; 6kW	8EA 726 025-001	Starter 255

MAN	HELLA
51.25201.7181	8EA 726 022-001
51.25201.9181	8EA 726 022-001
51.26201.7057	8EA 726 025-001
51.26201.7061	8EA 726 025-001
51.26201.7085	8EA 726 219-001
51.26201.7087	8EA 726 025-001
51.26201.7092	8EA 726 022-001
51.26201.7095	8EA 726 038-001
51.26201.7108	8EA 726 022-001
51.26201.7110	8EA 726 025-001
51.26201.7118	8EA 726 219-001
51.26201.7119	8EA 726 038-001
51.26201.7123	8EA 726 025-001
51.26201.7125	8EA 726 022-001
51.26201.7127	8EA 726 022-001
51.26201.7143	8EA 726 219-001
51.26201.7152	8EA 726 219-001
51.26201.7153	8EA 726 038-001
51.26201.7157	8EA 737 912-001
51.26201.7158	8EA 738 029-001
51.26201.7181	8EA 726 022-001
51.26201.7183	8EA 737 912-001
51.26201.9057	8EA 726 025-001
51.26201.9061	8EA 726 025-001
51.26201.9117	8EA 726 022-001
51.26201.9127	8EA 726 022-001
51.26201.9140	8EA 726 038-001
51.26201.9143	8EA 726 219-001

MERCEDES- BENZ	HELLA
000 151 28 01	8EA 726 025-001
001 151 97 01	8EA 726 025-001
002 151 02 01	8EA 726 025-001
002 151 53 01	8EA 726 022-001
003 151 45 01	8EA 726 022-001
003 151 46 01	8EA 726 025-001
003 151 64 01	8EA 726 022-001
004 151 60 01	8EA 726 022-001
004 151 60 01 80	8EA 726 022-001
004 151 61 01	8EA 726 025-001
004 151 61 01 80	8EA 726 025-001
005 151 27 01	8EA 726 022-001
005 151 28 01	8EA 726 025-001
A 000 151 28 01	8EA 726 025-001
A 001 151 97 01	8EA 726 025-001
A 002 151 02 01	8EA 726 025-001
A 002 151 53 01	8EA 726 022-001
A 003 151 45 01	8EA 726 022-001
A 003 151 46 01	8EA 726 025-001
A 003 151 64 01	8EA 726 022-001
A 004 151 60 01	8EA 726 022-001
A 004 151 60 01 80	8EA 726 022-001
A 004 151 61 01	8EA 726 025-001
A 004 151 61 01 80	8EA 726 025-001
A 005 151 27 01	8EA 726 022-001
A 005 151 28 01	8EA 726 025-001

RENAULT	HELLA
50 00 049 122	8EA 726 025-001
50 00 241 777	8EA 726 025-001
50 01 000 061	8EA 726 022-001



8EA ...

8EA 726 022-001	255
8EA 726 025-001	255
8EA 726 038-001	256
8EA 726 219-001	256
8EA 737 912-001	257
8EA 738 029-001	257



Alternator.....	292
Alternator Regulator.....	298

8EL 725 625-001
CA186IR



Alternator Charge Current [A]	55
Voltage [V]	14

8EL 725 644-001
CA222IR



Alternator Charge Current [A]	35
Voltage [V]	28

8EL 725 663-001
CA240IR



Alternator Charge Current [A]	55
Voltage [V]	28

8EL 725 729-001
CA327IR



Alternator Charge Current [A]	27
Belt Pulley Ø [mm]	79
Number of Ribs	1
Pulleys	with belt pulley
Voltage [V]	28

8EL 725 736-001
CA3331R



Alternator Charge Current [A]	55
Voltage [V]	28

8EL 730 008-001
CA7101R

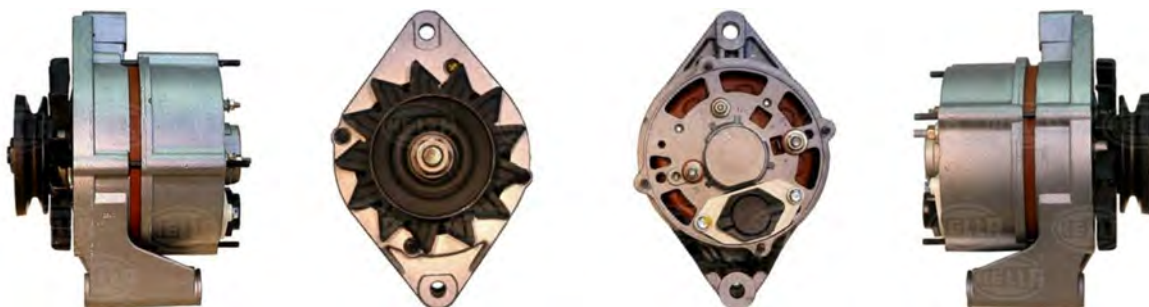

Alternator Charge Current [A]	35
Belt Pulley Ø [mm]	79
Number of Ribs	1
Pulleys	with belt pulley
Voltage [V]	28

8EL 731 715-001
CA854IR

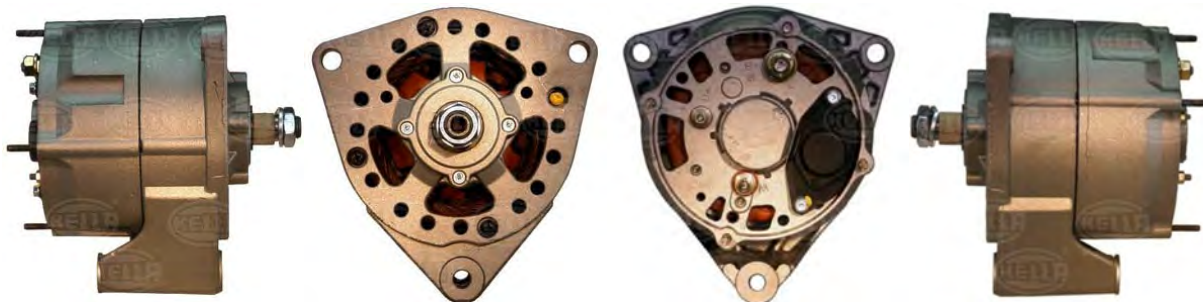

Alternator Charge Current [A]	35
Voltage [V]	28

8EL 732 707-001
CA1035IR

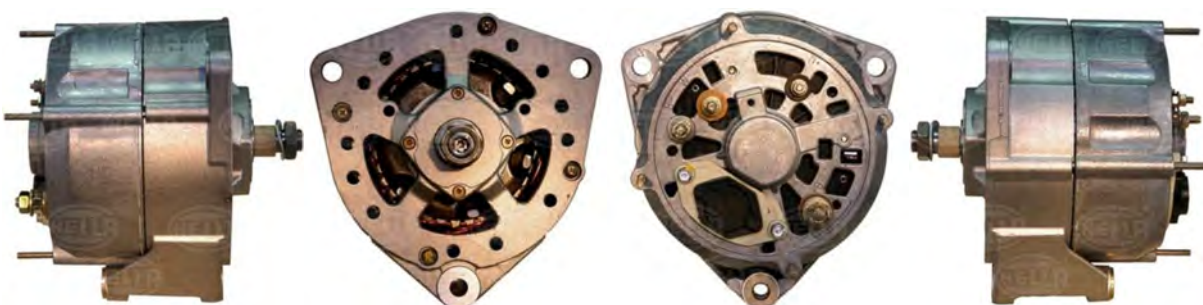

Alternator Charge Current [A]	80
Voltage [V]	28

8EL 737 052-001
CA1104IR

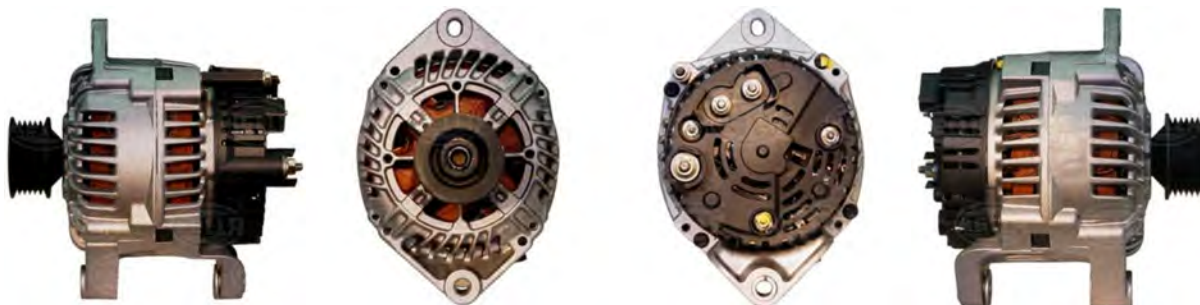

Alternator Charge Current [A]	110
Number of Ribs	6
Voltage [V]	14

8EL 737 365-001
CA1237IR



Alternator Charge Current [A]	140
Voltage [V]	28

8EL 737 985-001
CA1663IR



Alternator Charge Current [A]	90
Control Unit ID	PL110
Voltage [V]	28

8EL 738 055-001
CA1695IR



Alternator Charge Current [A]	55
Control Unit ID	PL110
Voltage [V]	28

8EL 738 211-021
CA1847IR



Alternator Charge Current [A]	80
Control Unit ID	PL82
Voltage [V]	28

8EL 738 211-251
CA1870IR



Alternator Charge Current [A]	80	Voltage [V]	28
Control Unit ID	PL82		

8EL 738 211-261
CA1871IR



Alternator Charge Current [A]	110
Control Unit ID	PL82
Voltage [V]	28

8EL 738 212-291
CA1997IR



Alternator Charge Current [A]	120
Control Unit ID	PL82
Voltage [V]	28

Regulator - Alternator Regulator

5DR 009 728-441



Alternator Number	<ul style="list-style-type: none"> • 0 121 541 002 • 0 124 555 001 • 0 124 555 002 • 0 124 555 004 • 0 124 555 007 • 0 124 555 008 • 0 124 655 001 • 0 124 655 002 • 0 124 655 004
Operating Voltage	28,3



MAN.....300

Manufacturer - Model	Power	Displ.	Year of Constr.	Remark	Part Number	Page
MAN - Cab-over Trucks						07/86→05/94
19.322 U, 19.322 UL, 19.322 ULL	235 kW		02/90→05/94	☺ D2865LF06; 55A	8EL 725 736-001 Alternator	294
				☺ D2865LF03; 55A	8EL 725 736-001 Alternator	294
				☺ D2865LF03; 35A	8EL 731 715-001 Alternator	295
				☺ D2865LF06; 35A	8EL 731 715-001 Alternator	295
				☺ D2865LF06; 80A	8EL 732 707-001 Alternator	295
				☺ D2865LF03; 80A	8EL 732 707-001 Alternator	295
19.332 U, 19.322 UL, 19.322 ULL 24.332 UNL, 24.332 UNLL	243 kW 243 kW		07/86→02/90 10/86→02/90	☺ D2866LUL/330; 55A	8EL 725 736-001 Alternator	294
19.362 U, 19.362 UL, 19.362 ULL 24.362 UNL, 24.362 UNLL	265 kW 265 kW		07/86→01/91 10/86→02/90	☺ D2866KUL; →engine 4912000; 35A	8EL 725 644-001 Alternator	292
				☺ D2866KUL; 55A	8EL 725 736-001 Alternator	294
				☺ D2866KUL; engine 4912001→; 35A	8EL 730 008-001 Alternator	294
19.372 U, 19.372 ULL	272 kW		02/90→05/94	☺ D2866LF05; 55A	8EL 725 736-001 Alternator	294
				☺ D2866LF03; 55A	8EL 725 736-001 Alternator	294
				☺ D2866LF03; 35A	8EL 731 715-001 Alternator	295
				☺ D2866LF05; 35A	8EL 731 715-001 Alternator	295
				☺ D2866LF05; 80A	8EL 732 707-001 Alternator	295
				☺ D2866LF03; 80A	8EL 732 707-001 Alternator	295
19.422 U, 19.422 ULL	309 kW		02/90→05/94	☺ D2866LF09; 35A	8EL 725 644-001 Alternator	292
				☺ D2866LF06; 55A	8EL 725 736-001 Alternator	294
				☺ D2866LF09; 55A	8EL 725 736-001 Alternator	294
				☺ D2866LF06; 35A	8EL 731 715-001 Alternator	295
				☺ D2866LF09; 80A	8EL 732 707-001 Alternator	295
				☺ D2866LF06; 80A	8EL 732 707-001 Alternator	295
24.322 UNL, 24.322 UNLL	235 kW		02/90→12/90	☺ D2865LF03; 35A	8EL 725 644-001 Alternator	292
				☺ D2865LF03; 55A	8EL 725 736-001 Alternator	294
				☺ D2865LF03; 80A	8EL 732 707-001 Alternator	295
24.372 UNL, 24.372 UNLL	272 kW		02/90→12/90	☺ D2866LF03; 35A	8EL 725 644-001 Alternator	292
				☺ D2866LF03; 55A	8EL 725 736-001 Alternator	294
				☺ D2866LF03; 80A	8EL 732 707-001 Alternator	295
24.422 UNL, 24.422 UNLL	309 kW		02/90→12/90	☺ D2866LF06; 35A	8EL 725 644-001 Alternator	292
				☺ D2866LF06; 55A	8EL 725 736-001 Alternator	294
				☺ D2866LF06; 80A	8EL 732 707-001 Alternator	295
25.322 UNL, 25.322 UNLL	235 kW		09/90→12/92	☺ D2865LF06; 35A	8EL 725 644-001 Alternator	292
				☺ D2865LF03; 35A	8EL 725 644-001 Alternator	292
				☺ D2865LF03; 55A	8EL 725 736-001 Alternator	294
				☺ D2865LF06; 55A	8EL 725 736-001 Alternator	294
				☺ D2865LF06; 80A	8EL 732 707-001 Alternator	295
				☺ D2865LF03; 80A	8EL 732 707-001 Alternator	295

Manufacturer - Model	Power	Displ.	Year of Constr.	Remark	Part Number	Page				
MAN - Cab-over Trucks						07/86→05/94				
25.372 UNL,25.372 UNLL	272 kW		09/90→12/92	☺ D2866LF03; 35A	8EL 725 644-001 Alternator	292				
				☺ D2866LF05; 35A	8EL 725 644-001 Alternator	292				
				☺ D2866LF05; 55A	8EL 725 736-001 Alternator	294				
				☺ D2866LF03; 55A	8EL 725 736-001 Alternator	294				
				☺ D2866LF03; 80A	8EL 732 707-001 Alternator	295				
				☺ D2866LF05; 80A	8EL 732 707-001 Alternator	295				
25.422 UNL,25.422 UNLL 26.422 UNL,26.422 UNLL	309 kW 309 kW		09/90→12/92 09/90→05/94	☺ D2866LF06; 35A	8EL 725 644-001 Alternator	292				
				☺ D2866LF09; 35A	8EL 725 644-001 Alternator	292				
				☺ D2866LF06; 55A	8EL 725 736-001 Alternator	294				
				☺ D2866LF09; 55A	8EL 725 736-001 Alternator	294				
				☺ D2866LF09; 80A	8EL 732 707-001 Alternator	295				
				☺ D2866LF06; 80A	8EL 732 707-001 Alternator	295				
26.322 UNL,26.322 UNLL	235 kW		09/90→05/94	09/90→; →10/92; ☺ D2865LF03; 35A	8EL 725 644-001 Alternator	292				
				09/90→; →01/93; ☺ D2865LF06; 35A	8EL 725 644-001 Alternator	292				
				☺ D2865LF06; 55A	8EL 725 736-001 Alternator	294				
				☺ D2865LF03; 55A	8EL 725 736-001 Alternator	294				
				01/93→; →05/94; ☺ D2865LF06; 35A	8EL 731 715-001 Alternator	295				
				☺ D2865LF06; 80A	8EL 732 707-001 Alternator	295				
				☺ D2865LF03; 80A	8EL 732 707-001 Alternator	295				
26.372 UNL,26.372 UNLL	272 kW		09/90→05/94	09/90→; →10/92; ☺ D2866LF03; 35A	8EL 725 644-001 Alternator	292				
				☺ D2866LF05; 35A	8EL 725 644-001 Alternator	292				
				☺ D2866LF05; 55A	8EL 725 736-001 Alternator	294				
				☺ D2866LF03; 55A	8EL 725 736-001 Alternator	294				
				☺ D2866LF03; 80A	8EL 732 707-001 Alternator	295				
				☺ D2866LF05; 80A	8EL 732 707-001 Alternator	295				
MAN - E 2000						05/00→				
19.310 FALK 19.310 FALS 19.310 FLK 19.310 FLS 26.310 FAVLC 26.310 FAVLK 28.310 FNLC	228 kW 228 kW 228 kW 228 kW 228 kW 228 kW 228 kW		05/00→ 05/00→ 05/00→ 05/00→ 05/00→ 05/00→ 05/00→	☺ D2866LF23; 90A	8EL 737 985-001 Alternator	296				
				19.360 FALK 19.360 FALS 19.360 FLK 19.360 FLS 26.360 FAVLC 26.360 FAVLK 28.360 FANLC 28.360 FANLK 28.360 FNALC 28.360 FNLC 30.360 FANLC 30.360 FANLK 30.360 FNLC 32.360 VFCL 32.360 VFNLC 33.360 DFAK, DFALK	265 kW 265 kW 265 kW 265 kW 265 kW 265 kW 265 kW 265 kW 265 kW 265 kW 265 kW 265 kW 265 kW 265 kW 265 kW		05/00→ 05/00→ 05/00→ 05/00→ 05/00→ 05/00→ 05/00→ 05/00→ 05/00→ 05/00→ 05/00→ 05/00→ 05/00→ 05/00→ 05/00→	☺ D2866LF24; 90A	8EL 737 985-001 Alternator	296

Manufacturer - Model	Power	Displ.	Year of Constr.	Remark	Part Number	Page			
MAN - E 2000						05/00→			
33.360 DFALC	265 kW		05/00→	D2866LF24; 90A	8EL 737 985-001 Alternator	296			
33.360 DFALS	265 kW		04/01→						
33.360 DFCL	265 kW		05/00→						
33.360 DFLK	265 kW		05/00→						
33.360 DFSL	265 kW		05/00→						
35.360 VFAK	265 kW		05/00→						
19.410 FALK	301 kW		05/00→	D2866LF25; 90A	8EL 737 985-001 Alternator	296			
19.410 FALS	301 kW		05/00→						
19.410 FLK	301 kW		05/00→						
19.410 FLS	301 kW		05/00→						
26.410 DFARC	301 kW		05/00→						
26.410 DFRC, FAVLC	301 kW		05/00→						
26.410 FAVLK	301 kW		05/00→						
28.410 FANLC	301 kW		05/00→						
28.410 FANLK	301 kW		05/00→						
28.410 FNLC	301 kW		05/00→						
30.410 FANLC	301 kW		05/00→						
30.410 FANLK	301 kW		05/00→						
30.410 FNLC	301 kW		05/00→						
32.410 VFARK	301 kW		05/00→						
32.410 VFCL, VFRC, VFRLC	301 kW		05/00→						
32.410 VFNLC	301 kW		05/00→						
33.410 DFAK, DFALK	301 kW		05/00→						
33.410 DFALC	301 kW		05/00→						
33.410 DFALS	301 kW		04/01→						
33.410 DFCL	301 kW		05/00→						
33.410 DFLK	301 kW		05/00→						
33.410 DFSL	301 kW		05/00→						
35.410 FVNLC	301 kW		05/00→						
35.410 VFAK	301 kW		05/00→						
41.410 VFAK	301 kW		05/00→						
50.410 VFAK	301 kW		05/00→						
50.410 VFAVK, VFAV-G	301 kW		03/01→						
50.410 VFK	301 kW		05/00→						
50.410 VFVK, VFV-G	301 kW		10/00→						
19.460 FALK	338 kW		05/00→				D2876LF03; 55A	8EL 725 736-001 Alternator	294
19.460 FALS	338 kW		05/00→						
19.460 FLK	338 kW		05/00→						
19.460 FLS	338 kW		05/00→						
26.460 DFARC	338 kW		05/00→						
26.460 DFRLS	338 kW		05/00→						
26.460 FAVLC	338 kW		05/00→						
26.460 FAVLK	338 kW		05/00→						
28.460 FANLC	338 kW		05/00→						
28.460 FANLK	338 kW		05/00→						
28.460 FNLC	338 kW		05/00→						
29.460 FVAS	338 kW		05/00→						
30.460 FANLC	338 kW		05/00→						
30.460 FANLK	338 kW		05/00→						
30.460 FNLC	338 kW		05/00→						
32.460 VFCL, VFRLC	338 kW		05/00→						
32.460 VFNLC	338 kW		05/00→						
33.460 DFAK, DFALK	338 kW		05/00→						
33.460 DFALC	338 kW		05/00→						
33.460 DFALS	338 kW		04/01→						
33.460 DFCL	338 kW		05/00→						
33.460 DFLK	338 kW		05/00→						
33.460 DFSL	338 kW		05/00→						
35.460 FVNLC	338 kW		05/00→						
35.460 VFAK	338 kW		05/00→						
41.460 DFVS, DFVLS	338 kW		06/00→						
41.460 VFAK	338 kW		05/00→						
50.460 VFAK	338 kW		05/00→						
50.460 VFAVK, VFAV-G	338 kW		03/01→						
50.460 VFK	338 kW		05/00→						
50.460 VFVK, VFV-G	338 kW		10/00→						
30.310 FNLC	228 kW		05/00→	D2866LF23; 55A	8EL 725 736-001 Alternator	294			
32.310 VFCL	228 kW		05/00→						
32.310 VFNLC	228 kW		05/00→						
							D2866LF23; 80A	8EL 732 707-001 Alternator	295
				D2866LF23; 90A	8EL 737 985-001 Alternator	296			
				D2866LF23; 55A	8EL 738 055-001 Alternator	297			

Manufacturer - Model	Power	Displ.	Year of Constr.	Remark	Part Number	Page
MAN - EL						01/93→
EL 202,EL 222	157 - 169 kW		01/93→06/97	☺ D0826LUH05; 140A	8EL 737 365-001 Alternator	296
				☺ D0826LUH03; 140A	8EL 737 365-001 Alternator	296
				☺ D0826LUH12; 140A	8EL 737 365-001 Alternator	296
EL 202,EL 262	184 kW		04/94→06/97	02/96→; →09/01; ☺ D0826LUH; 140A	8EL 737 365-001 Alternator	296
				☺ D0826LUH; 140A	8EL 737 365-001 Alternator	296
EL 262	191 kW		07/98→	07/98→; →09/01; ☺ D2866LUH22; 140A	8EL 737 365-001 Alternator	296
MAN - EM						08/87→
EM 192	140 kW		10/93→06/97	☺ D0826LOH06; 55A	8EL 725 736-001 Alternator	294
				☺ D0826LOH06; 35A	8EL 731 715-001 Alternator	295
				☺ D0826LOH06; 80A	8EL 732 707-001 Alternator	295
				☺ D0826LOH06; 140A	8EL 737 365-001 Alternator	296
EM 222,EM 223	162 kW		02/96→	02/96→; →09/01; ☺ D0826LUH12; 140A	8EL 737 365-001 Alternator	296
				02/96→; →09/01; ☺ D0826LOH15; 140A	8EL 737 365-001 Alternator	296
EM 223	162 kW		08/87→	07/98→; →09/01; ☺ D0826LOH15; 140A	8EL 737 365-001 Alternator	296
MAN - F 9						01/83→12/86
15.192 F, 15.192 FL	141 kW		01/83→12/86	☺ D2565MF; 35A	8EL 725 644-001 Alternator	292
15.192 FS	141 kW		01/83→12/86			
MAN - F 90						07/86→12/97
19.242 F,19.242 FL,19.242 FLL	177 kW		01/88→01/89	☺ D2866F/240; 35A	8EL 725 644-001 Alternator	292
19.242 FS,19.242 FLS,19.242 FLLS	177 kW		01/88→01/89	☺ D2866F/240; 55A	8EL 725 736-001 Alternator	294
24.242 DF	177 kW		01/88→07/89			
24.242 DFK	177 kW		01/88→07/89			
24.242 DFS	177 kW		01/88→07/89			
24.242 FNL,24.242 FNLL,24.242 FVL	177 kW		01/88→02/90			
26.242 DF	177 kW		01/88→07/89			
26.242 DFAK	177 kW		02/89→07/89			
26.242 DFK	177 kW		01/88→07/89			
26.242 DFS	177 kW		01/88→07/89			
33.242 DFAK	177 kW		01/88→08/88			
33.242 DFK	177 kW		01/88→08/88			
19.262 F,19.262 FL,19.262 FLL	191 kW		01/88→02/90	☺ D2865LF/260; 35A	8EL 725 644-001 Alternator	292
19.262 FAK	191 kW		02/89→02/90	☺ D2865LF/260; 55A	8EL 725 736-001 Alternator	294
19.262 FAS	191 kW		02/89→02/90			
19.262 FK	191 kW		01/88→02/90	☺ D2865LF/260; 80A	8EL 732 707-001 Alternator	295
19.262 FS,19.262 FLS,19.262 FLLS	191 kW		01/88→02/90			
24.262 DF	191 kW		01/88→02/90			
24.262 DFK	191 kW		01/88→02/90			
24.262 DFS,24.262 DFSL	191 kW		01/88→02/90			
24.262 FNL,24.262 FNLL,24.262 FVL	191 kW		01/88→02/90			
26.262 DF	191 kW		01/88→02/90			
26.262 DFA	191 kW		02/89→02/90			
26.262 DFAK	191 kW		02/89→02/90			
26.262 DFAS	191 kW		02/89→02/90			
26.262 DFK	191 kW		01/88→02/90			
26.262 DFS	191 kW		01/88→02/90			
32.262 VF	191 kW		02/89→02/90			
32.262 VFK	191 kW		02/89→02/90			
32.262 VFTM	191 kW		02/89→02/90			
33.262 DF	191 kW		08/88→02/90			
33.262 DFA	191 kW		07/89→02/90			
33.262 DFAK	191 kW		07/89→02/90			
33.262 DFK	191 kW		08/88→02/90			
35.262 VF	191 kW		02/89→02/90			
35.262 VFA	191 kW		07/89→02/90			
35.262 VFK	191 kW		02/89→02/90			

Manufacturer - Model	Power	Displ.	Year of Constr.	Remark	Part Number	Page
MAN - F 90				07/86→12/97		
41.262 VF	191 kW		07/89→02/90	☺ D2865LF/260; 35A	8EL 725 644-001 Alternator	292
41.262 VFK	191 kW		07/89→02/90	☺ D2865LF/260; 55A	8EL 725 736-001 Alternator	294
				☺ D2865LF/260; 80A	8EL 732 707-001 Alternator	295
19.272 F, 19.272 FL, 19.272 FLL	198 kW		02/90→05/95	02/90→; →10/93; ☺ D2865LF05; 35A	8EL 725 644-001 Alternator	292
19.272 FAK	198 kW		02/90→05/95			
19.272 FAS	198 kW		02/90→05/95	02/90→; →10/93; ☺ D2865LF02; 35A	8EL 725 644-001 Alternator	292
19.272 FK	198 kW		02/90→05/95			
19.272 FS, 19.272 FLS, 19.272 FLLS	198 kW		02/90→05/95	☺ D2865LF02; 55A	8EL 725 736-001 Alternator	294
				☺ D2865LF05; 55A	8EL 725 736-001 Alternator	294
				11/93→; →05/95; ☺ D2865LF05; 35A	8EL 731 715-001 Alternator	295
				☺ D2865LF05; 80A	8EL 732 707-001 Alternator	295
				☺ D2865LF02; 80A	8EL 732 707-001 Alternator	295
19.272 FA	198 kW		02/90→05/95	02/90→; →10/93; ☺ D2865LF05; 35A	8EL 725 644-001 Alternator	292
				02/90→; →10/92; ☺ D2865LF02; 35A	8EL 725 644-001 Alternator	292
				☺ D2865LF02; 55A	8EL 725 736-001 Alternator	294
				☺ D2865LF05; 55A	8EL 725 736-001 Alternator	294
				11/93→; →05/95; ☺ D2865LF05; 35A	8EL 731 715-001 Alternator	295
				☺ D2865LF05; 80A	8EL 732 707-001 Alternator	295
				☺ D2865LF02; 80A	8EL 732 707-001 Alternator	295
19.292 F, 19.292 FL, 19.292 FLL	213 kW		07/86→02/90	☺ D2866LF/290; 35A	8EL 725 644-001 Alternator	292
19.292 FA	213 kW		05/88→02/90			
19.292 FAK	213 kW		05/88→02/90	☺ D2866LF/290; 55A	8EL 725 736-001 Alternator	294
19.292 FAS	213 kW		05/88→02/90			
19.292 FK	213 kW		07/86→02/90	☺ D2866LF/290; 80A	8EL 732 707-001 Alternator	295
19.292 FS, 19.292 FLS, 19.292 FLLS	213 kW		07/86→02/90			
24.292 DF	213 kW		04/87→02/90			
24.292 DFK	213 kW		04/87→02/90			
24.292 DFS, 24.292 DFSL	213 kW		04/87→02/90			
24.292 FNL, 24.292 FNLL, 24.292 FVL	213 kW		10/86→02/90			
24.292 FNLS, 24.292 FVLS	213 kW		10/86→02/90			
26.292 DF, 26.292 DFL	213 kW		09/87→02/90			
26.292 DFA	213 kW		05/88→02/90			
26.292 DFAK	213 kW		05/88→02/90			
26.292 DFAS	213 kW		05/88→02/90			
26.292 DFK	213 kW		09/87→02/90			
26.292 DFS	213 kW		09/87→02/90			
32.292 VF	213 kW		03/88→02/90			
32.292 VFK	213 kW		03/88→02/90			
33.292 DF	213 kW		09/87→02/90			
33.292 DFA	213 kW		05/88→02/90			
33.292 DFAK	213 kW		05/88→02/90			
33.292 DFAS	213 kW		05/88→02/90			
33.292 DFK	213 kW		09/87→02/90			
33.292 DFS	213 kW		09/87→02/90			
41.292 VF	213 kW		10/88→02/90			
41.292 VFK	213 kW		10/88→02/90			
48.292 VF	213 kW		07/89→02/90			
48.292 VFA	213 kW		07/89→02/90			
48.292 VFAK	213 kW		07/89→02/90			
19.322 F, 19.322 FL, 19.322 FLL	235 kW		02/90→05/95	02/90→; →10/93; ☺ D2865LF06; 35A	8EL 725 644-001 Alternator	292
19.322 FK	235 kW		02/90→05/95			
19.322 FS, 19.322 FLS, 19.322 FLLS	235 kW		02/90→05/95	02/90→; →10/93; ☺ D2865LF03; 35A	8EL 725 644-001 Alternator	292
				☺ D2865LF06; 55A	8EL 725 736-001 Alternator	294
				☺ D2865LF03; 55A	8EL 725 736-001 Alternator	294
				11/93→; →05/95; ☺ D2865LF06; 35A	8EL 731 715-001 Alternator	295

Manufacturer - Model	Power	Displ.	Year of Constr.	Remark	Part Number	Page
MAN - F 90					07/86→12/97	
19.322 F,19.322 FL,19.322 FLL	235 kW		02/90→05/95	☺ D2865LF03; 80A	8EL 732 707-001 Alternator	295
19.322 FK	235 kW		02/90→05/95			
19.322 FS,19.322 FLS,19.322 FLLS	235 kW		02/90→05/95	☺ D2865LF06; 80A	8EL 732 707-001 Alternator	295
19.322 FA	235 kW		02/90→06/96	02/90→; -08/93; ☺ D2865LF06; 35A	8EL 725 644-001 Alternator	292
				02/90→; -08/93; ☺ D2865LF03; 35A	8EL 725 644-001 Alternator	292
				07/93→; -06/96; ☺ D2865LF06; 55A	8EL 725 736-001 Alternator	294
				02/90→; -09/93; ☺ D2865LF06; 35A	8EL 731 715-001 Alternator	295
				☺ D2865LF03; 80A	8EL 732 707-001 Alternator	295
				☺ D2865LF06; 80A	8EL 732 707-001 Alternator	295
19.322 FAK	235 kW		02/90→06/96	02/90→; -08/93; ☺ D2865LF06; 35A	8EL 725 644-001 Alternator	292
19.322 FAS	235 kW		02/90→06/96			
				02/90→; -08/93; ☺ D2865LF03; 35A	8EL 725 644-001 Alternator	292
				07/93→; -06/96; ☺ D2865LF06; 55A	8EL 725 736-001 Alternator	294
				09/93→; -06/96; ☺ D2865LF06; 35A	8EL 731 715-001 Alternator	295
				☺ D2865LF03; 80A	8EL 732 707-001 Alternator	295
				☺ D2865LF06; 80A	8EL 732 707-001 Alternator	295
19.332 F,19.332 FL,19.332 FLL	243 kW		07/86→02/90	☺ D2866LF/330; 35A	8EL 725 644-001 Alternator	292
19.332 FA	243 kW		05/88→02/90			
19.332 FAK	243 kW		05/88→02/90	☺ D2866LF/330; 55A	8EL 725 736-001 Alternator	294
19.332 FAS	243 kW		05/88→02/90			
19.332 FS,19.332 FLS,19.332 FLLS	243 kW		07/86→02/90	☺ D2866LF/330; 80A	8EL 732 707-001 Alternator	295
24.332 DF	243 kW		04/87→02/90			
24.332 DFK	243 kW		04/87→02/90			
24.332 DFS,24.332 DFLS	243 kW		04/87→02/90			
24.332 FNL,24.332 FNLL,24.332 FVL	243 kW		10/86→02/90			
24.332 FNLS,24.332 FVLS	243 kW		10/86→02/90			
26.332 DF, 26.332 DFL	243 kW		09/87→02/90			
26.332 DFA	243 kW		05/88→02/90			
26.332 DFAK	243 kW		05/88→02/90			
26.332 DFAS	243 kW		05/88→02/90			
26.332 DFK	243 kW		09/87→02/90			
26.332 DFS	243 kW		09/87→02/90			
32.332 VF	243 kW		03/88→02/90			
32.332 VFK	243 kW		03/88→02/90			
33.332 DF	243 kW		09/87→02/90			
33.332 DFA	243 kW		05/88→02/90			
33.332 DFAK	243 kW		05/88→02/90			
33.332 DFAS	243 kW		05/88→02/90			
33.332 DFK	243 kW		09/87→02/90			
33.332 DFS	243 kW		09/87→02/90			
41.332 VF	243 kW		10/88→02/90			
41.332 VFK	243 kW		10/88→02/90			
48.332 VF	243 kW		07/89→02/90			
48.332 VFA	243 kW		07/89→02/90			
48.332 VFAK	243 kW		07/89→02/90			
19.342 F,19.342 FL,19.342 FLL	250 kW		05/94→05/95	☺ D2865LF09; 55A	8EL 725 736-001 Alternator	294
19.342 FAK	250 kW		05/94→06/96			
19.342 FAS	250 kW		05/94→06/96	☺ D2865LF09; 35A	8EL 731 715-001 Alternator	295
19.342 FK	250 kW		05/94→05/95			
19.342 FS,19.342 FLS,19.342 FLLS	250 kW		05/94→05/95	☺ D2865LF09; 80A	8EL 732 707-001 Alternator	295
24.342 FNL,24.342 FNLL	250 kW		05/94→05/95			
26.342 DF,26.342 DFL	250 kW		05/94→06/96			
26.342 DFK,26.342 DFLK	250 kW		05/94→06/96			
32.342 VFK	250 kW		05/94→06/96			
33.342 DF	250 kW		05/94→06/96			
33.342 DFA	250 kW		05/94→06/96			
35.342 VF	250 kW		05/94→06/96			
35.342 VFK	250 kW		05/94→06/96			

Manufacturer - Model	Power	Displ.	Year of Constr.	Remark	Part Number	Page
MAN - F 90					07/86→12/97	
19.342 FA	250 kW		05/94→06/96	05/94→; →05/95; ☼ D2865LF09; 55A	8EL 725 736-001 Alternator	294
				05/94→; →05/95; ☼ D2865LF09; 35A	8EL 731 715-001 Alternator	295
				05/94→; →05/95; ☼ D2865LF09; 80A	8EL 732 707-001 Alternator	295
19.362 F, 19.362 FL, 19.362 FLL	265 kW		07/86→02/90	☼ D2866LXF; 35A	8EL 725 644-001 Alternator	292
19.362 FK	265 kW		07/86→02/90			
19.362 FS, 19.362 FLS, 19.362 FLLS	265 kW		07/86→02/90	☼ D2866KF; 35A	8EL 725 644-001 Alternator	292
24.362 DF	265 kW		04/87→02/90	☼ D2866KF; 55A	8EL 725 736-001 Alternator	294
24.362 DFK	265 kW		04/87→02/90			
24.362 DFS, 24.362 DFSL	265 kW		04/87→02/90	☼ D2866LXF; 55A	8EL 725 736-001 Alternator	294
24.362 FNL, 24.362 FNLL, 24.362 FVL	265 kW		10/86→02/90			
24.362 FNLS, 24.362 FVLS	265 kW		10/86→02/90	☼ D2866KF; 80A	8EL 732 707-001 Alternator	295
26.362 DF, 26.362 DFL	265 kW		09/87→02/90			
26.362 DFK	265 kW		09/87→02/90	☼ D2866LXF; 80A	8EL 732 707-001 Alternator	295
26.362 DFS	265 kW		09/87→02/90			
33.362 DF	265 kW		09/87→02/90			
33.362 DFK	265 kW		09/87→02/90			
33.362 DFS	265 kW		09/87→02/90			
19.362 FA	265 kW		05/88→02/90	☼ D2866LXF; 35A	8EL 725 644-001 Alternator	292
19.362 FAK	265 kW		05/88→02/90			
19.362 FAS	265 kW		05/88→02/90	☼ D2866LXF; 55A	8EL 725 736-001 Alternator	294
26.362 DFA	265 kW		05/88→02/90			
26.362 DFAK	265 kW		05/88→02/90	☼ D2866LXF; 80A	8EL 732 707-001 Alternator	295
26.362 DFAS	265 kW		05/88→02/90			
32.362 VF	265 kW		03/88→02/90			
32.362 VFK	265 kW		03/88→02/90			
33.362 DFA	265 kW		05/88→02/90			
33.362 DFAK	265 kW		05/88→02/90			
33.362 DFAS	265 kW		05/88→02/90			
35.362 VF	265 kW		10/88→02/90			
35.362 VFK	265 kW		10/88→02/90			
41.362 VF	265 kW		10/88→02/90			
41.362 VFK	265 kW		10/88→02/90			
48.362 VF	265 kW		07/89→02/90			
48.362 VFA	265 kW		07/89→02/90			
48.362 VFAK	265 kW		07/89→02/90			
19.372 F, 19.372 FL, 19.372 FLL	249 kW		05/90→04/95	☼ D2866LXF/SILENT; 35A	8EL 725 644-001 Alternator	292
19.372 FK	249 kW		05/90→04/95			
19.372 FS, 19.372 FLS, 19.372 FLLS	249 kW		05/90→04/95	☼ D2866LXF/SILENT; 55A	8EL 725 736-001 Alternator	294
32.372 VFK	249 kW		05/90→04/95			
35.372 VF	249 kW		02/90→04/95			
35.372 VFK	249 kW		02/90→04/95			
19.372 F, 19.372 FL, 19.372 FLL	272 kW		02/90→05/95	02/90→; →10/93; ☼ D2866LF03; 35A	8EL 725 644-001 Alternator	292
19.372 FK	272 kW		02/90→05/95			
19.372 FS, 19.372 FLS, 19.372 FLLS	272 kW		02/90→05/95	☼ D2866LF05; 35A	8EL 725 644-001 Alternator	292
				☼ D2866LF15; 35A	8EL 725 644-001 Alternator	292
				☼ D2866LF03; 55A	8EL 725 736-001 Alternator	294
				☼ D2866LF05; 55A	8EL 725 736-001 Alternator	294
				☼ D2866LF15; 55A	8EL 725 736-001 Alternator	294
				☼ D2866LF03; 80A	8EL 732 707-001 Alternator	295
				☼ D2866LF05; 80A	8EL 732 707-001 Alternator	295
				☼ D2866LF15; 80A	8EL 732 707-001 Alternator	295
19.372 FA	272 kW		02/90→06/96	02/90→; →08/93; ☼ D2866LF05; 35A	8EL 725 644-001 Alternator	292
19.372 FAK	272 kW		02/90→06/96			
				02/90→; →08/93; ☼ D2866LF03; 35A	8EL 725 644-001 Alternator	292
				02/90→; →04/92; ☼ D2866LF03; 55A	8EL 725 736-001 Alternator	294
				09/93→; →06/96; ☼ D2866LF05; 35A	8EL 731 715-001 Alternator	295
				09/93→; →06/96; ☼ D2866LF15; 35A	8EL 731 715-001 Alternator	295
				☼ D2866LF03; 80A	8EL 732 707-001 Alternator	295

Manufacturer - Model	Power	Displ.	Year of Constr.	Remark	Part Number	Page
MAN - F 90						07/86→12/97
19.372 FA	272 kW		02/90→06/96	☺ D2866LF05; 80A	8EL 732 707-001 Alternator	295
19.372 FAK	272 kW		02/90→06/96	☺ D2866LF15; 80A	8EL 732 707-001 Alternator	295
19.372 FAS	272 kW		02/90→06/96	02/90→; -08/93; ☺ D2866LF05; 35A	8EL 725 644-001 Alternator	292
				02/90→; -08/93; ☺ D2866LF03; 35A	8EL 725 644-001 Alternator	292
				02/90→; -04/92; ☺ D2866LF03; 55A	8EL 725 736-001 Alternator	294
				09/93→; -06/96; ☺ D2866LF15; 35A	8EL 731 715-001 Alternator	295
				09/93→; -06/96; ☺ D2866LF05; 35A	8EL 731 715-001 Alternator	295
				02/90→; -04/92; ☺ D2866LF15; 80A	8EL 732 707-001 Alternator	295
				☺ D2866LF03; 80A	8EL 732 707-001 Alternator	295
				☺ D2866LF05; 80A	8EL 732 707-001 Alternator	295
19.402 F,19.402 FL,19.402 FLL	294 kW		05/94→05/95	☺ D2866LF16; 35A	8EL 725 644-001 Alternator	292
19.402 FK	294 kW		05/94→05/95			
19.402 FS,19.402 FLS,19.402 FLLS	294 kW		05/94→05/95	☺ D2866LF16; 55A	8EL 725 736-001 Alternator	294
24.402 FNL,24.402 FNLL	294 kW		05/94→05/95	☺ D2866LF16; 80A	8EL 732 707-001 Alternator	295
26.402 DFS	294 kW		05/94→12/95			
19.402 FA	294 kW		05/94→06/96	☺ D2866LF16; 35A	8EL 731 715-001 Alternator	295
19.402 FAK	294 kW		05/94→06/96			
19.402 FAS	294 kW		05/94→06/96	☺ D2866LF16; 80A	8EL 732 707-001 Alternator	295
26.402 DF,26.402 DFL	294 kW		05/94→06/96			
26.402 DFK,26.402 DFLK	294 kW		05/94→06/96			
26.402 FNL,26.402 FNLL,26.402 FVL	294 kW		05/94→06/96			
32.402 VFK	294 kW		05/94→06/96			
33.402 DF	294 kW		05/94→06/96			
33.402 DFA	294 kW		05/94→06/96			
33.402 DFAK	294 kW		05/94→06/96			
33.402 DFK	294 kW		05/94→06/96			
33.402 DFS	294 kW		05/94→06/96			
35.402 VF	294 kW		05/94→06/96			
35.402 VFK	294 kW		05/94→06/96			
40.402 DF	294 kW		05/95→06/96			
40.402 DFA	294 kW		05/95→06/96			
41.402 VF	294 kW		05/94→06/96			
19.422 F,19.422 FL,19.422 FLL	309 kW		02/90→05/95	☺ D2866LF09; 35A	8EL 725 644-001 Alternator	292
19.422 FS,19.422 FLS,19.422 FLLS	309 kW		02/90→05/95	02/90→; -10/92; ☺ D2866LF06; 35A	8EL 725 644-001 Alternator	292
				☺ D2866LF10; 35A	8EL 725 644-001 Alternator	292
				☺ D2866LF09; 55A	8EL 725 736-001 Alternator	294
				☺ D2866LF10; 55A	8EL 725 736-001 Alternator	294
				02/90→; -10/92; ☺ D2866LF06; 55A	8EL 725 736-001 Alternator	294
				☺ D2866LF09; 80A	8EL 732 707-001 Alternator	295
				02/90→; -10/92; ☺ D2866LF06; 80A	8EL 732 707-001 Alternator	295
				☺ D2866LF10; 80A	8EL 732 707-001 Alternator	295
19.422 FA	309 kW		02/90→06/96	02/90→; -08/93; ☺ D2866LF09; 35A	8EL 725 644-001 Alternator	292
19.422 FAK	309 kW		02/90→06/96	02/90→; -08/93; ☺ D2866LF06; 35A	8EL 725 644-001 Alternator	292
				02/90→; -04/92; ☺ D2866LF06; 55A	8EL 725 736-001 Alternator	294
				09/93→; -06/96; ☺ D2866LF09; 35A	8EL 731 715-001 Alternator	295
				☺ D2866LF06; 80A	8EL 732 707-001 Alternator	295
				☺ D2866LF09; 80A	8EL 732 707-001 Alternator	295

Manufacturer - Model	Power	Displ.	Year of Constr.	Remark	Part Number	Page
MAN - F 90					07/86→12/97	
19.422 FAS	309 kW		02/90→06/96	02/90→; →08/93; ☺ D2866LF06; 35A	8EL 725 644-001 Alternator	292
				☺ D2866LF09; 35A	8EL 725 644-001 Alternator	292
				02/90→; →04/92; ☺ D2866LF06; 55A	8EL 725 736-001 Alternator	294
				09/93→; →06/96; ☺ D2866LF09; 35A	8EL 731 715-001 Alternator	295
				☺ D2866LF06; 80A	8EL 732 707-001 Alternator	295
				☺ D2866LF09; 80A	8EL 732 707-001 Alternator	295
19.422 FK	309 kW		02/90→05/95	02/90→; →10/92; ☺ D2866LF06; 35A	8EL 725 644-001 Alternator	292
				☺ D2866LF09; 35A	8EL 725 644-001 Alternator	292
				☺ D2866LF09; 55A	8EL 725 736-001 Alternator	294
				02/90→; →10/92; ☺ D2866LF06; 55A	8EL 725 736-001 Alternator	294
				02/90→; →10/92; ☺ D2866LF06; 80A	8EL 732 707-001 Alternator	295
				☺ D2866LF09; 80A	8EL 732 707-001 Alternator	295
19.462 F, 19.462 FL	338 kW		05/87→02/90	☺ D2840LF/460; 35A	8EL 725 644-001 Alternator	292
19.462 FK	338 kW		05/87→02/90			
19.462 FS, 19.462 FLS	338 kW		05/87→02/90	☺ D2840LF/460; 55A	8EL 725 736-001 Alternator	294
24.462 DF	338 kW		02/89→02/90			
24.462 DFS	338 kW		02/89→02/90	☺ D2840LF/460; 80A	8EL 732 707-001 Alternator	295
24.462 FNL	338 kW		04/89→02/90			
24.462 FVLS	338 kW		05/87→07/87			
26.462 DF	338 kW		02/89→02/90			
26.462 DFA	338 kW		08/89→02/90			
26.462 DFAS	338 kW		08/89→02/90			
26.462 DFS	338 kW		02/89→02/90			
33.462 DF	338 kW		07/89→02/90			
33.462 DFA	338 kW		07/89→02/90			
40.462 DF	338 kW		07/89→02/90			
40.462 DFA	338 kW		07/89→02/90			
48.462 VF	338 kW		07/89→02/90			
19.502 F, 19.502 FL, 19.502 FLL	368 kW		02/90→06/96	☺ D2840LF01; 35A	8EL 725 644-001 Alternator	292
19.502 FS, 19.502 FLS, 19.502 FLLS	368 kW		02/90→06/96	☺ D2840LF06; 35A	8EL 725 644-001 Alternator	292
26.502 FNL, 26.502 FNLL	368 kW		09/91→06/96			
33.502 DF	368 kW		09/91→06/96	☺ D2840LF04; 35A	8EL 725 644-001 Alternator	292
33.502 DFA	368 kW		09/91→06/96			
40.502 DFA	368 kW		02/90→06/96	☺ D2840LF01; 55A	8EL 725 736-001 Alternator	294
				☺ D2840LF06; 55A	8EL 725 736-001 Alternator	294
				☺ D2840LF04; 55A	8EL 725 736-001 Alternator	294
				☺ D2840LF01; 35A	8EL 731 715-001 Alternator	295
				☺ D2840LF04; 35A	8EL 731 715-001 Alternator	295
				☺ D2840LF06; 35A	8EL 731 715-001 Alternator	295
				☺ D2840LF04; 80A	8EL 732 707-001 Alternator	295
				☺ D2840LF06; 80A	8EL 732 707-001 Alternator	295
				☺ D2840LF01; 80A	8EL 732 707-001 Alternator	295
24.272 DF	198 kW		02/90→12/90	☺ D2865LF02; 35A	8EL 725 644-001 Alternator	292
24.272 DFK	198 kW		02/90→12/90			
24.272 DFS, 24.272 DFLS	198 kW		02/90→04/95	☺ D2865LF02; 55A	8EL 725 736-001 Alternator	294
35.272 VF	198 kW		02/90→12/91			
35.272 VFK	198 kW		02/90→12/92	☺ D2865LF02; 80A	8EL 732 707-001 Alternator	295
41.272 VF	198 kW		02/90→12/91			
24.272 FNL, 24.272 FNLL, 24.272 FVL	198 kW		02/90→05/95	02/90→; →10/93; ☺ D2865LF02; 35A	8EL 725 644-001 Alternator	292
24.272 FNLS, 24.272 FVLS	198 kW		02/90→05/95	☺ D2865LF05; 55A	8EL 725 736-001 Alternator	294

Manufacturer - Model	Power	Displ.	Year of Constr.	Remark	Part Number	Page
MAN - F 90					07/86→12/97	
24.272 FNL,24.272 FNLL,24.272 FVL	198 kW		02/90→05/95	☺ D2865LF02; 55A	8EL 725 736-001 Alternator	294
24.272 FNLS,24.272 FVLS	198 kW		02/90→05/95	☺ D2865LF05; 35A	8EL 731 715-001 Alternator	295
				11/93→; →05/95; ☺ D2865LF02; 35A	8EL 731 715-001 Alternator	295
				☺ D2865LF05; 80A	8EL 732 707-001 Alternator	295
				☺ D2865LF02; 80A	8EL 732 707-001 Alternator	295
24.302 DF	220 kW		05/90→12/90	☺ D2866LF04; 35A	8EL 725 644-001 Alternator	292
24.302 DFK	220 kW		05/90→12/90			
24.302 DFS,24.302 DFLS	220 kW		05/90→04/95	☺ D2866LF04; 55A	8EL 725 736-001 Alternator	294
24.302 FNL,24.302 FNLL,24.302 FVL	220 kW		05/90→10/90	☺ D2866LF04; 80A	8EL 732 707-001 Alternator	295
25.302 DF	220 kW		09/90→12/91			
25.302 DFK	220 kW		09/90→12/91			
25.302 DFS, 25.302 DFLS	220 kW		09/90→12/91			
25.302 FNL, 25.302 FNLL, 25.302 FVL	220 kW		09/90→12/91			
25.302 FNLS, 25.302 FVLS	220 kW		09/90→12/91			
26.302 DF	220 kW		05/90→12/91			
26.302 DFA	220 kW		05/90→12/91			
26.302 DFAK	220 kW		05/90→12/91			
26.302 DFAS	220 kW		05/90→12/91			
26.302 DFK	220 kW		05/90→12/91			
26.302 DFS	220 kW		05/90→12/91			
26.302 FNL, 26.302 FNLL, 26.302 FVL	220 kW		03/91→12/91			
26.302 FNLS,26.302 FVLS	220 kW		09/90→12/91			
32.302 VF	220 kW		05/90→09/91			
32.302 VFK	220 kW		05/90→09/91			
35.302 VF	220 kW		05/90→09/91			
35.302 VFA	220 kW		05/90→09/91			
35.302 VFAK	220 kW		05/90→09/91			
35.302 VFK	220 kW		05/90→09/91			
24.322 DF	235 kW		02/90→12/90	☺ D2865LF03; 35A	8EL 725 644-001 Alternator	292
24.322 DFK	235 kW		02/90→12/90			
24.322 DFS,24.322 DFLS	235 kW		02/90→12/90	☺ D2865LF03; 55A	8EL 725 736-001 Alternator	294
				☺ D2865LF03; 80A	8EL 732 707-001 Alternator	295
24.322 FNL,24.322 FNLL,24.322 FVL	235 kW		02/90→05/95	02/90→; →12/90; ☺ D2865LF03; 35A	8EL 725 644-001 Alternator	292
24.322 FNLS,24.322 FVLS	235 kW		02/90→05/95	☺ D2865LF06; 55A	8EL 725 736-001 Alternator	294
				☺ D2865LF03; 55A	8EL 725 736-001 Alternator	294
				☺ D2865LF06; 35A	8EL 731 715-001 Alternator	295
				☺ D2865LF03; 80A	8EL 732 707-001 Alternator	295
				☺ D2865LF06; 80A	8EL 732 707-001 Alternator	295
24.372 DF	249 kW		05/90→12/90	☺ D2866LXF/SILENT; 35A	8EL 725 644-001 Alternator	292
24.372 DFK	249 kW		05/90→12/90			
24.372 DFS	249 kW		05/90→12/90	☺ D2866LXF/SILENT; 55A	8EL 725 736-001 Alternator	294
24.372 FVL	249 kW		05/90→12/90			
24.372 FVLS	249 kW		05/90→12/90	☺ D2866LXF/SILENT; 80A	8EL 732 707-001 Alternator	295
25.372 DF	249 kW		09/90→12/92			
25.372 DFK	249 kW		09/90→12/92			
25.372 DFS	249 kW		09/90→12/92			
25.372 FVLS	249 kW		09/90→10/93			
24.372 DF	272 kW		02/90→12/90	☺ D2866LF03; 35A	8EL 725 644-001 Alternator	292
24.372 DFK	272 kW		02/90→12/90			
				☺ D2866LF03; 55A	8EL 725 736-001 Alternator	294
				☺ D2866LF03; 80A	8EL 732 707-001 Alternator	295
24.372 DFS, 24.372 DFLS	272 kW		02/90→04/95	02/90→; →10/92; ☺ D2866LF03; 35A	8EL 725 644-001 Alternator	292
				02/90→; →10/92; ☺ D2866LF03; 55A	8EL 725 736-001 Alternator	294
				02/90→; →10/92; ☺ D2866LF03; 80A	8EL 732 707-001 Alternator	295

Manufacturer - Model	Power	Displ.	Year of Constr.	Remark	Part Number	Page
MAN - F 90					07/86→12/97	
24.372 FNL,24.372 FNLL,24.372 FVL	272 kW		02/90→05/95	☺ D2866LF15; 35A	8EL 725 644-001 Alternator	292
24.372 FNLS,24.372 FVLS	272 kW		02/90→05/95	☺ D2866LF03; 35A	8EL 725 644-001 Alternator	292
				☺ D2866LF15; 55A	8EL 725 736-001 Alternator	294
				☺ D2866LF03; 55A	8EL 725 736-001 Alternator	294
				☺ D2866LF03; 80A	8EL 732 707-001 Alternator	295
				☺ D2866LF15; 80A	8EL 732 707-001 Alternator	295
24.422 DF	309 kW		02/90→12/90	☺ D2866LF06; 35A	8EL 725 644-001 Alternator	292
24.422 DFK	309 kW		02/90→12/90			
24.422 DFS,24.422 DFLS	309 kW		02/90→12/90	☺ D2866LF06; 55A	8EL 725 736-001 Alternator	294
				☺ D2866LF06; 80A	8EL 732 707-001 Alternator	295
24.422 FNL,24.422 FNLL,24.422 FVL	309 kW		02/90→05/95	☺ D2866LF06; 35A	8EL 725 644-001 Alternator	292
				☺ D2866LF09; 35A	8EL 725 644-001 Alternator	292
				☺ D2866LF09; 55A	8EL 725 736-001 Alternator	294
				☺ D2866LF06; 55A	8EL 725 736-001 Alternator	294
				☺ D2866LF09; 80A	8EL 732 707-001 Alternator	295
				☺ D2866LF06; 80A	8EL 732 707-001 Alternator	295
24.502 DF	368 kW		02/90→12/90	☺ D2840LF01; 55A	8EL 725 736-001 Alternator	294
24.502 DFK	368 kW		02/90→12/90			
24.502 DFS	368 kW		02/90→12/90	☺ D2840LF01; 35A	8EL 731 715-001 Alternator	295
24.502 FNL	368 kW		02/90→12/90	☺ D2840LF01; 80A	8EL 732 707-001 Alternator	295
25.272 DF	198 kW		09/90→12/92	☺ D2865LF05; 35A	8EL 725 644-001 Alternator	292
25.272 DFK	198 kW		09/90→12/92			
25.272 DFS,25.272 DFLS	198 kW		09/90→12/92	☺ D2865LF02; 35A	8EL 725 644-001 Alternator	292
25.272 FNL,25.272 FNLL,25.272 FVL	198 kW		09/90→10/93	☺ D2865LF02; 55A	8EL 725 736-001 Alternator	294
26.272 DFA	198 kW		02/90→12/92			
26.272 DFAK	198 kW		02/90→12/92	☺ D2865LF05; 55A	8EL 725 736-001 Alternator	294
26.272 DFAS	198 kW		02/90→12/92	☺ D2865LF05; 80A	8EL 732 707-001 Alternator	295
				☺ D2865LF02; 80A	8EL 732 707-001 Alternator	295
25.322 DF, 25.322 DFL	235 kW		09/90→12/92	☺ D2865LF03; 35A	8EL 725 644-001 Alternator	292
25.322 DFK	235 kW		09/90→12/92			
25.322 DFS, 25.322 DFLS	235 kW		09/90→12/92	☺ D2865LF06; 35A	8EL 725 644-001 Alternator	292
25.322 FNL, 25.322 FNLL, 25.322 FVL	235 kW		09/90→12/92	☺ D2865LF06; 55A	8EL 725 736-001 Alternator	294
25.322 FNLS,25.322 FVLS	235 kW		09/90→12/92	☺ D2865LF03; 55A	8EL 725 736-001 Alternator	294
				☺ D2865LF03; 80A	8EL 732 707-001 Alternator	295
				☺ D2865LF06; 80A	8EL 732 707-001 Alternator	295
25.372 DF	272 kW		09/90→12/92	☺ D2866LF05; 35A	8EL 725 644-001 Alternator	292
25.372 DFK	272 kW		09/90→12/92			
25.372 DFS,25.372 DFLS	272 kW		09/90→12/92	☺ D2866LF03; 35A	8EL 725 644-001 Alternator	292
25.372 FNL, 25.372 FNLL, 25.372 FVL	272 kW		09/90→12/92	☺ D2866LF03; 55A	8EL 725 736-001 Alternator	294
25.372 FNLS,25.372 FVLS	272 kW		09/90→10/93			
26.372 DFA	272 kW		02/90→12/92	☺ D2866LF05; 55A	8EL 725 736-001 Alternator	294
26.372 DFAS	272 kW		02/90→12/92	☺ D2866LF03; 80A	8EL 732 707-001 Alternator	295
				☺ D2866LF05; 80A	8EL 732 707-001 Alternator	295

Manufacturer - Model	Power	Displ.	Year of Constr.	Remark	Part Number	Page
MAN - F 90					07/86→12/97	
25.422 DF	309 kW		09/90→12/92	☺ D2866LF09; 35A	8EL 725 644-001	292
25.422 DFK	309 kW		09/90→12/92		Alternator	
25.422 DFS,25.422 DFLS	309 kW		09/90→12/92	☺ D2866LF06; 35A	8EL 725 644-001	292
25.422 FNL,25.422 FNLL	309 kW		09/90→12/92		Alternator	
25.422 FNLS,25.422 FVLS	309 kW		09/90→12/92	☺ D2866LF06; 55A	8EL 725 736-001	294
26.422 DFA	309 kW		02/90→12/92		Alternator	
26.422 DFAK	309 kW		02/90→12/92	☺ D2866LF09; 55A	8EL 725 736-001	294
26.422 DFAS	309 kW		02/90→12/92		Alternator	
				☺ D2866LF06; 80A	8EL 732 707-001	295
				☺ D2866LF09; 80A	8EL 732 707-001	295
					Alternator	
25.502 DF	368 kW		09/90→12/92	☺ D2840LF04; 55A	8EL 725 736-001	294
25.502 DFS	368 kW		09/90→12/92		Alternator	
26.502 DFA	368 kW		02/90→12/92	☺ D2840LF01; 55A	8EL 725 736-001	294
26.502 DFAS	368 kW		02/90→12/92		Alternator	
				☺ D2840LF01; 35A	8EL 731 715-001	295
					Alternator	
				☺ D2840LF04; 35A	8EL 731 715-001	295
					Alternator	
				☺ D2840LF04; 80A	8EL 732 707-001	295
					Alternator	
				☺ D2840LF01; 80A	8EL 732 707-001	295
					Alternator	
25.502 FNL	368 kW		09/90→12/92	☺ D2840LF04; 35A	8EL 725 644-001	292
					Alternator	
				☺ D2840LF01; 55A	8EL 725 736-001	294
					Alternator	
				☺ D2840LF04; 55A	8EL 725 736-001	294
					Alternator	
				☺ D2840LF01; 35A	8EL 731 715-001	295
					Alternator	
				☺ D2840LF01; 80A	8EL 732 707-001	295
					Alternator	
				☺ D2840LF04; 80A	8EL 732 707-001	295
					Alternator	
26.272 DF	198 kW		02/90→06/96	02/90→; →10/92; ☺ D2865LF02; 35A	8EL 725 644-001	292
					Alternator	
				01/93→; →08/93; ☺ D2865LF05; 35A	8EL 725 644-001	292
					Alternator	
				07/93→; →06/96; ☺ D2865LF05; 55A	8EL 725 736-001	294
					Alternator	
				09/93→; →06/96; ☺ D2865LF05; 35A	8EL 731 715-001	295
					Alternator	
				02/90→; →10/92; ☺ D2865LF05; 80A	8EL 732 707-001	295
					Alternator	
				02/90→; →10/92; ☺ D2865LF02; 80A	8EL 732 707-001	295
					Alternator	
26.272 DFK	198 kW		02/90→06/96	01/93→; →08/93; ☺ D2865LF02; 35A	8EL 725 644-001	292
					Alternator	
				01/93→; →08/93; ☺ D2865LF05; 35A	8EL 725 644-001	292
					Alternator	
				07/93→; →06/96; ☺ D2865LF05; 55A	8EL 725 736-001	294
					Alternator	
				07/93→; →06/96; ☺ D2865LF02; 55A	8EL 725 736-001	294
					Alternator	
				09/93→; →06/96; ☺ D2865LF05; 35A	8EL 731 715-001	295
					Alternator	
				09/93→; →06/96; ☺ D2865LF02; 35A	8EL 731 715-001	295
					Alternator	
				01/93→; →06/96; ☺ D2865LF05; 80A	8EL 732 707-001	295
					Alternator	
				01/93→; →06/96; ☺ D2865LF02; 80A	8EL 732 707-001	295
					Alternator	
26.272 DFS,26.272 DFLS	198 kW		02/90→06/96	02/90→; →08/93; ☺ D2865LF02; 35A	8EL 725 644-001	292
					Alternator	
				01/93→; →08/93; ☺ D2865LF05; 35A	8EL 725 644-001	292
					Alternator	
				07/93→; →06/96; ☺ D2865LF02; 55A	8EL 725 736-001	294
					Alternator	
				07/93→; →06/96; ☺ D2865LF05; 55A	8EL 725 736-001	294
					Alternator	
				09/93→; →06/96; ☺ D2865LF05; 35A	8EL 731 715-001	295
					Alternator	

Manufacturer - Model	Power	Displ.	Year of Constr.	Remark	Part Number	Page
MAN - F 90					07/86→12/97	
26.272 DFS,26.272 DFLS	198 kW		02/90→06/96	09/93→; -06/96; ☺ D2865LF02; 35A	8EL 731 715-001 Alternator	295
				01/93→; -06/96; ☺ D2865LF05; 80A	8EL 732 707-001 Alternator	295
				02/90→; -10/92; ☺ D2865LF02; 80A	8EL 732 707-001 Alternator	295
26.272 FNL,26.272 FNLL	198 kW		03/91→05/95	03/91→; -10/93; ☺ D2865LF05; 35A	8EL 725 644-001 Alternator	292
				☺ D2865LF05; 55A	8EL 725 736-001 Alternator	294
				11/93→; -05/95; ☺ D2865LF05; 35A	8EL 731 715-001 Alternator	295
				☺ D2865LF05; 80A	8EL 732 707-001 Alternator	295
26.272 FNLS,26.272 FVLS	198 kW		09/90→12/95	09/90→; -10/93; ☺ D2865LF05; 35A	8EL 725 644-001 Alternator	292
				09/90→; -12/92; ☺ D2865LF02; 35A	8EL 725 644-001 Alternator	292
				☺ D2865LF02; 55A	8EL 725 736-001 Alternator	294
				☺ D2865LF05; 55A	8EL 725 736-001 Alternator	294
				11/93→; -12/95; ☺ D2865LF05; 35A	8EL 731 715-001 Alternator	295
				☺ D2865LF05; 80A	8EL 732 707-001 Alternator	295
				☺ D2865LF02; 80A	8EL 732 707-001 Alternator	295
26.322 DF	235 kW		02/90→06/96	02/90→; -10/92; ☺ D2865LF03; 35A	8EL 725 644-001 Alternator	292
				01/93→; -08/93; ☺ D2865LF06; 35A	8EL 725 644-001 Alternator	292
				07/93→; -06/96; ☺ D2865LF06; 55A	8EL 725 736-001 Alternator	294
				09/93→; -06/96; ☺ D2865LF06; 35A	8EL 731 715-001 Alternator	295
				01/93→; -06/96; ☺ D2865LF06; 80A	8EL 732 707-001 Alternator	295
				02/90→; -10/92; ☺ D2865LF03; 80A	8EL 732 707-001 Alternator	295
26.322 DFA 26.322 DFAS	235 kW 235 kW		02/90→12/92 02/90→12/92	10/92→; -12/92; ☺ D2865LF03; 35A	8EL 725 644-001 Alternator	292
				☺ D2865LF06; 35A	8EL 725 644-001 Alternator	292
	☺ D2865LF06; 55A			8EL 725 736-001 Alternator	294	
	10/92→; -12/92; ☺ D2865LF03; 80A			8EL 732 707-001 Alternator	295	
	☺ D2865LF06; 80A			8EL 732 707-001 Alternator	295	
26.322 DFAK	235 kW		02/90→12/92	10/92→; -12/92; ☺ D2865LF03; 35A	8EL 725 644-001 Alternator	292
				☺ D2865LF06; 35A	8EL 725 644-001 Alternator	292
				☺ D2865LF06; 55A	8EL 725 736-001 Alternator	294
				10/90→; -12/92; ☺ D2865LF03; 80A	8EL 732 707-001 Alternator	295
				☺ D2865LF06; 80A	8EL 732 707-001 Alternator	295
26.322 DFK	235 kW		02/92→06/96	02/92→; -08/93; ☺ D2865LF03; 35A	8EL 725 644-001 Alternator	292
				02/92→; -08/93; ☺ D2865LF06; 35A	8EL 725 644-001 Alternator	292
				07/93→; -06/96; ☺ D2865LF03; 55A	8EL 725 736-001 Alternator	294
				07/93→; -06/96; ☺ D2865LF06; 55A	8EL 725 736-001 Alternator	294
				09/93→; -06/96; ☺ D2865LF06; 35A	8EL 731 715-001 Alternator	295
				09/93→; -06/96; ☺ D2865LF03; 35A	8EL 731 715-001 Alternator	295
				☺ D2865LF03; 80A	8EL 732 707-001 Alternator	295

Manufacturer - Model	Power	Displ.	Year of Constr.	Remark	Part Number	Page
MAN - F 90					07/86→12/97	
26.322 DFK	235 kW		02/92→06/96	☺ D2865LF06; 80A	8EL 732 707-001 Alternator	295
26.322 DFS,26.322 DFLS	235 kW		02/90→06/96	02/90→; -08/93; ☺ D2865LF06; 35A	8EL 725 644-001 Alternator	292
				02/90→; -08/93; ☺ D2865LF03; 35A	8EL 725 644-001 Alternator	292
				07/93→; -06/96; ☺ D2865LF06; 55A	8EL 725 736-001 Alternator	294
				09/93→; -06/96; ☺ D2865LF03; 35A	8EL 731 715-001 Alternator	295
				09/93→; -06/96; ☺ D2865LF06; 35A	8EL 731 715-001 Alternator	295
				07/93→; -06/96; ☺ D2865LF03; 80A	8EL 732 707-001 Alternator	295
				☺ D2865LF06; 80A	8EL 732 707-001 Alternator	295
				☺ D2865LF03; 80A	8EL 732 707-001 Alternator	295
26.322 FNL,26.322 FNLL	235 kW		03/91→05/95	03/91→; -10/92; ☺ D2865LF03; 35A	8EL 725 644-001 Alternator	292
				03/91→; -10/93; ☺ D2865LF06; 35A	8EL 725 644-001 Alternator	292
				☺ D2865LF06; 55A	8EL 725 736-001 Alternator	294
				☺ D2865LF03; 55A	8EL 725 736-001 Alternator	294
				11/93→; -05/95; ☺ D2865LF06; 35A	8EL 731 715-001 Alternator	295
				☺ D2865LF03; 80A	8EL 732 707-001 Alternator	295
				☺ D2865LF06; 80A	8EL 732 707-001 Alternator	295
26.322 FNLS,26.322 FVLS	235 kW		09/90→12/95	09/90→; -10/93; ☺ D2865LF06; 35A	8EL 725 644-001 Alternator	292
				09/90→; -10/92; ☺ D2865LF03; 35A	8EL 725 644-001 Alternator	292
				☺ D2865LF06; 55A	8EL 725 736-001 Alternator	294
				☺ D2865LF03; 55A	8EL 725 736-001 Alternator	294
				11/93→; -12/95; ☺ D2865LF06; 35A	8EL 731 715-001 Alternator	295
				☺ D2865LF03; 80A	8EL 732 707-001 Alternator	295
				☺ D2865LF06; 80A	8EL 732 707-001 Alternator	295
26.342 DFS	250 kW		04/94→06/96	05/94→; -06/96; ☺ D2865LF09; 55A	8EL 725 736-001 Alternator	294
				05/94→; -06/96; ☺ D2865LF09; 35A	8EL 731 715-001 Alternator	295
				05/94→; -06/96; ☺ D2865LF09; 80A	8EL 732 707-001 Alternator	295
26.372 DF,26.372 DFL	272 kW		02/90→06/96	02/90→; -10/92; ☺ D2866LF03; 35A	8EL 725 644-001 Alternator	292
				02/90→; -10/92; ☺ D2866LF05; 35A	8EL 725 644-001 Alternator	292
				02/90→; -10/92; ☺ D2866LF15; 35A	8EL 725 644-001 Alternator	292
				02/90→; -04/92; ☺ D2866LF15; 55A	8EL 725 736-001 Alternator	294
				02/90→; -04/92; ☺ D2866LF05; 55A	8EL 725 736-001 Alternator	294
				02/90→; -04/92; ☺ D2866LF03; 55A	8EL 725 736-001 Alternator	294
				02/90→; -10/92; ☺ D2866LF15; 80A	8EL 732 707-001 Alternator	295
				02/90→; -10/92; ☺ D2866LF03; 80A	8EL 732 707-001 Alternator	295
				02/90→; -10/92; ☺ D2866LF05; 80A	8EL 732 707-001 Alternator	295

Manufacturer - Model	Power	Displ.	Year of Constr.	Remark	Part Number	Page
MAN - F 90					07/86→12/97	
26.372 DFAK	272 kW		01/92→06/96	01/92→; -12/92; ☺ D2866LF05; 35A	8EL 725 644-001 Alternator	292
				01/92→; -12/92; ☺ D2866LF03; 35A	8EL 725 644-001 Alternator	292
				01/92→; -04/92; ☺ D2866LF03; 55A	8EL 725 736-001 Alternator	294
				01/92→; -12/92; ☺ D2866LF03; 80A	8EL 732 707-001 Alternator	295
				01/92→; -12/92; ☺ D2866LF05; 80A	8EL 732 707-001 Alternator	295
26.372 DFK	272 kW		01/92→06/96	01/92→; -08/93; ☺ D2866LF03; 35A	8EL 725 644-001 Alternator	292
				01/92→; -08/93; ☺ D2866LF15; 35A	8EL 725 644-001 Alternator	292
				01/92→; -08/93; ☺ D2866LF05; 35A	8EL 725 644-001 Alternator	292
				01/92→; -04/92; ☺ D2866LF03; 55A	8EL 725 736-001 Alternator	294
				09/93→; -06/96; ☺ D2866LF03; 35A	8EL 731 715-001 Alternator	295
				09/93→; -06/96; ☺ D2866LF15; 35A	8EL 731 715-001 Alternator	295
				09/93→; -06/96; ☺ D2866LF05; 35A	8EL 731 715-001 Alternator	295
				☺ D2866LF05; 80A	8EL 732 707-001 Alternator	295
				☺ D2866LF03; 80A	8EL 732 707-001 Alternator	295
				☺ D2866LF15; 80A	8EL 732 707-001 Alternator	295
				26.372 DFS 32.372 VFK	272 kW 272 kW	
09/93→; -06/96; ☺ D2866LF15; 35A	8EL 731 715-001 Alternator	295				
09/93→; -06/96; ☺ D2866LF05; 35A	8EL 731 715-001 Alternator	295				
09/93→; -06/96; ☺ D2866LF03; 35A	8EL 731 715-001 Alternator	295				
10/92→; -06/96; ☺ D2866LF05; 80A	8EL 732 707-001 Alternator	295				
10/92→; -06/96; ☺ D2866LF03; 80A	8EL 732 707-001 Alternator	295				
10/92→; -06/96; ☺ D2866LF15; 80A	8EL 732 707-001 Alternator	295				
26.372 FNL,26.372 FNLL,26.372 FVL	272 kW		09/90→12/95	09/90→; -10/92; ☺ D2866LF03; 35A	8EL 725 644-001 Alternator	292
				☺ D2866LF05; 35A	8EL 725 644-001 Alternator	292
				☺ D2866LF15; 35A	8EL 725 644-001 Alternator	292
				☺ D2866LF05; 55A	8EL 725 736-001 Alternator	294
				☺ D2866LF03; 55A	8EL 725 736-001 Alternator	294
				☺ D2866LF15; 55A	8EL 725 736-001 Alternator	294
				☺ D2866LF03; 80A	8EL 732 707-001 Alternator	295
				☺ D2866LF05; 80A	8EL 732 707-001 Alternator	295
26.372 FNLS,26.372 FVLS	272 kW		01/92→06/96	01/92→; -05/94; ☺ D2866LF05; 35A	8EL 725 644-001 Alternator	292
				01/92→; -05/94; ☺ D2866LF03; 35A	8EL 725 644-001 Alternator	292
				10/92→; -05/94; ☺ D2866LF05; 55A	8EL 725 736-001 Alternator	294
				01/92→; -04/92; ☺ D2866LF03; 55A	8EL 725 736-001 Alternator	294
				09/93→; -12/95; ☺ D2866LF05; 35A	8EL 731 715-001 Alternator	295
				09/93→; -12/95; ☺ D2866LF15; 35A	8EL 731 715-001 Alternator	295

Manufacturer - Model	Power	Displ.	Year of Constr.	Remark	Part Number	Page
MAN - F 90				07/86→12/97		
26.372 FNLS,26.372 FVLS	272 kW		01/92→06/96	01/92→; -12/95; ☺ D2866LF15; 80A	8EL 732 707-001 Alternator	295
				01/92→; -12/95; ☺ D2866LF03; 80A	8EL 732 707-001 Alternator	295
				01/92→; -12/95; ☺ D2866LF05; 80A	8EL 732 707-001 Alternator	295
26.402 FNLS,26.402 FVLS	294 kW		05/94→06/96	05/94→; -12/95; ☺ D2866LF16; 35A	8EL 731 715-001 Alternator	295
				05/94→; -12/95; ☺ D2866LF16; 80A	8EL 732 707-001 Alternator	295
26.422 DF,26.422 DFL	309 kW		02/90→06/96	01/93→; -08/93; ☺ D2866LF06; 35A	8EL 725 644-001 Alternator	292
				01/93→; -08/93; ☺ D2866LF09; 35A	8EL 725 644-001 Alternator	292
				02/90→; -10/92; ☺ D2866LF06; 35A	8EL 725 644-001 Alternator	292
				02/90→; -04/92; ☺ D2866LF06; 55A	8EL 725 736-001 Alternator	294
				09/93→; -06/96; ☺ D2866LF06; 35A	8EL 731 715-001 Alternator	295
				09/93→; -06/96; ☺ D2866LF09; 35A	8EL 731 715-001 Alternator	295
				02/90→; -10/92; ☺ D2866LF06; 80A	8EL 732 707-001 Alternator	295
				01/93→; -06/96; ☺ D2866LF09; 80A	8EL 732 707-001 Alternator	295
26.422 DFK 26.422 DFS	309 kW 309 kW		02/90→12/95 02/90→12/95	02/90→; -10/92; ☺ D2866LF06; 35A	8EL 725 644-001 Alternator	292
				☺ D2866LF09; 35A	8EL 725 644-001 Alternator	292
				☺ D2866LF06; 55A	8EL 725 736-001 Alternator	294
				☺ D2866LF09; 55A	8EL 725 736-001 Alternator	294
				☺ D2866LF06; 80A	8EL 732 707-001 Alternator	295
				☺ D2866LF09; 80A	8EL 732 707-001 Alternator	295
26.422 FNL,26.422 FNLL,26.422 FVL	309 kW		09/90→12/95	09/90→; -10/92; ☺ D2866LF06; 35A	8EL 725 644-001 Alternator	292
				☺ D2866LF09; 35A	8EL 725 644-001 Alternator	292
				☺ D2866LF06; 55A	8EL 725 736-001 Alternator	294
				☺ D2866LF09; 55A	8EL 725 736-001 Alternator	294
				☺ D2866LF06; 80A	8EL 732 707-001 Alternator	295
				☺ D2866LF09; 80A	8EL 732 707-001 Alternator	295
26.422 FNLS,26.422 FVLS	309 kW		01/92→12/95	01/92→; -10/92; ☺ D2866LF06; 35A	8EL 725 644-001 Alternator	292
				☺ D2866LF09; 35A	8EL 725 644-001 Alternator	292
				☺ D2866LF06; 55A	8EL 725 736-001 Alternator	294
				☺ D2866LF09; 55A	8EL 725 736-001 Alternator	294
				☺ D2866LF06; 80A	8EL 732 707-001 Alternator	295
				☺ D2866LF09; 80A	8EL 732 707-001 Alternator	295
26.502 DF	368 kW		02/90→06/96	02/90→; -10/92; ☺ D2840LF04; 35A	8EL 725 644-001 Alternator	292
				02/90→; -10/92; ☺ D2840LF06; 35A	8EL 725 644-001 Alternator	292
				02/90→; -10/92; ☺ D2840LF01; 35A	8EL 725 644-001 Alternator	292
				02/90→; -10/92; ☺ D2840LF04; 55A	8EL 725 736-001 Alternator	294
				02/90→; -10/92; ☺ D2840LF06; 55A	8EL 725 736-001 Alternator	294
				☺ D2840LF01; 55A	8EL 725 736-001 Alternator	294

Manufacturer - Model	Power	Displ.	Year of Constr.	Remark	Part Number	Page			
MAN - F 90				07/86→12/97					
26.502 DF	368 kW		02/90→06/96	02/90→; -10/92; ☺ D2840LF06; 35A	8EL 731 715-001 Alternator	295			
				02/90→; -10/92; ☺ D2840LF04; 35A	8EL 731 715-001 Alternator	295			
				02/90→; -10/92; ☺ D2840LF01; 35A	8EL 731 715-001 Alternator	295			
				02/90→; -10/92; ☺ D2840LF01; 80A	8EL 732 707-001 Alternator	295			
				02/90→; -10/92; ☺ D2840LF06; 80A	8EL 732 707-001 Alternator	295			
				02/90→; -10/92; ☺ D2840LF04; 80A	8EL 732 707-001 Alternator	295			
26.502 DFS,26.502 DFLS	368 kW		02/90→06/96	10/92→; -06/96; ☺ D2840LF04; 35A	8EL 725 644-001 Alternator	292			
				10/92→; -06/96; ☺ D2840LF06; 35A	8EL 725 644-001 Alternator	292			
				10/92→; -06/96; ☺ D2840LF04; 55A	8EL 725 736-001 Alternator	294			
				10/92→; -06/96; ☺ D2840LF06; 55A	8EL 725 736-001 Alternator	294			
				10/92→; -06/96; ☺ D2840LF06; 35A	8EL 731 715-001 Alternator	295			
				10/92→; -06/96; ☺ D2840LF04; 35A	8EL 731 715-001 Alternator	295			
				10/92→; -06/96; ☺ D2840LF04; 80A	8EL 732 707-001 Alternator	295			
				10/92→; -06/96; ☺ D2840LF06; 80A	8EL 732 707-001 Alternator	295			
32.272 VF 32.272 VFK	198 kW		02/90→04/95	02/90→; -10/93; ☺ D2865LF05; 35A	8EL 725 644-001 Alternator	292			
				02/90→; -10/93; ☺ D2865LF02; 35A	8EL 725 644-001 Alternator	292			
				☺ D2865LF05; 55A	8EL 725 736-001 Alternator	294			
				☺ D2865LF02; 55A	8EL 725 736-001 Alternator	294			
	198 kW		02/90→04/95	11/93→; -04/95; ☺ D2865LF02; 35A	8EL 731 715-001 Alternator	295			
				11/93→; -04/95; ☺ D2865LF05; 35A	8EL 731 715-001 Alternator	295			
				☺ D2865LF05; 80A	8EL 732 707-001 Alternator	295			
				☺ D2865LF02; 80A	8EL 732 707-001 Alternator	295			
32.322 VF 32.322 VFK 35.322 VK	235 kW		02/90→06/96	02/90→; -08/93; ☺ D2865LF06; 35A	8EL 725 644-001 Alternator	292			
				02/90→; -08/93; ☺ D2865LF03; 35A	8EL 725 644-001 Alternator	292			
	235 kW		02/90→06/96	07/93→; -05/94; ☺ D2865LF06; 55A	8EL 725 736-001 Alternator	294			
				07/93→; -05/94; ☺ D2865LF03; 55A	8EL 725 736-001 Alternator	294			
				09/93→; -05/94; ☺ D2865LF03; 35A	8EL 731 715-001 Alternator	295			
				09/93→; -05/94; ☺ D2865LF06; 35A	8EL 731 715-001 Alternator	295			
				02/90→; -05/94; ☺ D2865LF03; 80A	8EL 732 707-001 Alternator	295			
				02/90→; -05/94; ☺ D2865LF06; 80A	8EL 732 707-001 Alternator	295			
				249 kW		02/90→06/96	05/90→; -04/95; ☺ D2866LXF/SILENT; 35A	8EL 725 644-001 Alternator	292
							05/90→; -04/95; ☺ D2866LXF/SILENT; 55A	8EL 725 736-001 Alternator	294
32.372 VF 35.372 VF	272 kW		02/90→06/96	02/90→; -08/93; ☺ D2866LF15; 35A	8EL 725 644-001 Alternator	292			
				02/90→; -08/93; ☺ D2866LF05; 35A	8EL 725 644-001 Alternator	292			
	272 kW		02/90→12/97	02/90→; -08/93; ☺ D2866LF03; 35A	8EL 725 644-001 Alternator	292			
				02/90→; -04/92; ☺ D2866LF15; 55A	8EL 725 736-001 Alternator	294			
				02/90→; -04/92; ☺ D2866LF05; 55A	8EL 725 736-001 Alternator	294			

Manufacturer - Model	Power	Displ.	Year of Constr.	Remark	Part Number	Page
MAN - F 90					07/86→12/97	
32.372 VF 35.372 VF	272 kW 272 kW		02/90→06/96 02/90→12/97	02/90→; →04/92; ☺ D2866LF03; 55A 09/93→; →05/94; ☺ D2866LF03; 35A 09/93→; →05/94; ☺ D2866LF05; 35A 09/93→; →05/94; ☺ D2866LF15; 35A 02/90→; →05/94; ☺ D2866LF15; 80A 02/90→; →05/94; ☺ D2866LF05; 80A 02/90→; →05/94; ☺ D2866LF03; 80A	8EL 725 736-001 Alternator 8EL 731 715-001 Alternator 8EL 731 715-001 Alternator 8EL 731 715-001 Alternator 8EL 732 707-001 Alternator 8EL 732 707-001 Alternator 8EL 732 707-001 Alternator	294 295 295 295 295 295 295
32.422 VF 41.422 VF	309 kW 309 kW		02/90→06/96 02/90→06/96	02/90→; →08/93; ☺ D2866LF09; 35A 02/90→; →08/93; ☺ D2866LF06; 35A 02/90→; →04/92; ☺ D2866LF06; 55A 09/93→; →06/96; ☺ D2866LF09; 35A 09/93→; →06/96; ☺ D2866LF06; 35A ☺ D2866LF06; 80A ☺ D2866LF09; 80A	8EL 725 644-001 Alternator 8EL 725 644-001 Alternator 8EL 725 736-001 Alternator 8EL 731 715-001 Alternator 8EL 731 715-001 Alternator 8EL 732 707-001 Alternator 8EL 732 707-001 Alternator	292 292 294 295 295 295 295
32.422 VFK	309 kW		02/90→06/96	→08/93; ☺ D2866LF06; 35A →04/92; ☺ D2866LF06; 55A →08/93; ☺ D2866LF06; 35A →05/94; ☺ D2866LF06; 80A	8EL 725 644-001 Alternator 8EL 725 736-001 Alternator 8EL 731 715-001 Alternator 8EL 732 707-001 Alternator	292 294 295 295
33.272 DF 33.272 DFA 33.272 FVL	198 kW 198 kW 191 - 198 kW		10/92→04/95 10/92→04/95 10/92→04/95	10/92→; →10/93; ☺ D2865LF05; 35A ☺ D2865LF05; 55A 11/93→; →04/95; ☺ D2865LF05; 35A ☺ D2865LF05; 80A	8EL 725 644-001 Alternator 8EL 725 736-001 Alternator 8EL 731 715-001 Alternator 8EL 732 707-001 Alternator	292 294 295 295
33.322 DF 33.322 DFA 33.322 FVL	235 kW 235 kW 235 kW		09/91→06/96 09/91→06/96 09/91→06/96	09/91→; →08/93; ☺ D2865LF03; 35A 09/91→; →08/93; ☺ D2865LF06; 35A 07/93→; →06/96; ☺ D2865LF06; 55A 07/93→; →06/96; ☺ D2865LF03; 55A 09/93→; →06/96; ☺ D2865LF06; 35A 09/93→; →06/96; ☺ D2865LF03; 35A ☺ D2865LF03; 80A ☺ D2865LF06; 80A	8EL 725 644-001 Alternator 8EL 725 644-001 Alternator 8EL 725 736-001 Alternator 8EL 725 736-001 Alternator 8EL 731 715-001 Alternator 8EL 731 715-001 Alternator 8EL 732 707-001 Alternator 8EL 732 707-001 Alternator	292 292 294 294 295 295 295 295
33.372 DF	272 kW		09/91→06/96	09/91→; →08/93; ☺ D2866LF03; 35A 09/91→; →08/93; ☺ D2866LF05; 35A 09/91→; →08/93; ☺ D2866LF15; 35A 09/91→; →04/92; ☺ D2866LF03; 55A 09/93→; →05/94; ☺ D2866LF05; 35A 09/91→; →05/94; ☺ D2866LF15; 80A 09/91→; →05/94; ☺ D2866LF05; 80A	8EL 725 644-001 Alternator 8EL 725 644-001 Alternator 8EL 725 644-001 Alternator 8EL 725 736-001 Alternator 8EL 731 715-001 Alternator 8EL 732 707-001 Alternator 8EL 732 707-001 Alternator	292 292 292 294 295 295 295

Manufacturer - Model	Power	Displ.	Year of Constr.	Remark	Part Number	Page
MAN - F 90					07/86→12/97	
33.372 DF	272 kW		09/91→06/96	09/91→; -05/94; ⚙️ D2866LF03; 80A	8EL 732 707-001 Alternator	295
33.372 DFA	272 kW		09/91→06/96	09/91→; -08/93; ⚙️ D2866LF05; 35A	8EL 725 644-001 Alternator	292
				09/91→; -08/93; ⚙️ D2866LF03; 35A	8EL 725 644-001 Alternator	292
				09/91→; -08/93; ⚙️ D2866LF15; 35A	8EL 725 644-001 Alternator	292
				09/91→; -04/92; ⚙️ D2866LF03; 55A	8EL 725 736-001 Alternator	294
				09/93→; -06/96; ⚙️ D2866LF15; 35A	8EL 731 715-001 Alternator	295
				09/93→; -06/96; ⚙️ D2866LF05; 35A	8EL 731 715-001 Alternator	295
				09/93→; -06/96; ⚙️ D2866LF03; 35A	8EL 731 715-001 Alternator	295
				⚙️ D2866LF03; 80A	8EL 732 707-001 Alternator	295
				⚙️ D2866LF05; 80A	8EL 732 707-001 Alternator	295
				⚙️ D2866LF15; 80A	8EL 732 707-001 Alternator	295
33.372 DFAK	272 kW		01/91→06/96	09/91→; -08/93; ⚙️ D2866LF03; 35A	8EL 725 644-001 Alternator	292
				09/91→; -08/93; ⚙️ D2866LF05; 35A	8EL 725 644-001 Alternator	292
				09/91→; -08/93; ⚙️ D2866LF15; 35A	8EL 725 644-001 Alternator	292
				09/91→; -04/92; ⚙️ D2866LF03; 55A	8EL 725 736-001 Alternator	294
				09/93→; -05/94; ⚙️ D2866LF05; 35A	8EL 731 715-001 Alternator	295
				09/93→; -05/94; ⚙️ D2866LF03; 35A	8EL 731 715-001 Alternator	295
				09/93→; -05/94; ⚙️ D2866LF15; 35A	8EL 731 715-001 Alternator	295
				09/91→; -05/94; ⚙️ D2866LF15; 80A	8EL 732 707-001 Alternator	295
				09/91→; -05/94; ⚙️ D2866LF05; 80A	8EL 732 707-001 Alternator	295
				09/91→; -05/94; ⚙️ D2866LF03; 80A	8EL 732 707-001 Alternator	295
33.372 DFK	272 kW		01/91→06/96	09/91→; -08/93; ⚙️ D2866LF03; 35A	8EL 725 644-001 Alternator	292
				09/91→; -08/93; ⚙️ D2866LF15; 35A	8EL 725 644-001 Alternator	292
				09/91→; -04/92; ⚙️ D2866LF03; 55A	8EL 725 736-001 Alternator	294
				09/93→; -05/94; ⚙️ D2866LF05; 35A	8EL 731 715-001 Alternator	295
				09/93→; -05/94; ⚙️ D2866LF03; 35A	8EL 731 715-001 Alternator	295
				09/93→; -05/94; ⚙️ D2866LF15; 35A	8EL 731 715-001 Alternator	295
				09/91→; -05/94; ⚙️ D2866LF15; 80A	8EL 732 707-001 Alternator	295
				09/91→; -05/94; ⚙️ D2866LF05; 80A	8EL 732 707-001 Alternator	295
				09/91→; -05/94; ⚙️ D2866LF03; 80A	8EL 732 707-001 Alternator	295
33.372 DFS	272 kW		09/91→06/96	09/91→; -08/93; ⚙️ D2866LF03; 35A	8EL 725 644-001 Alternator	292
				09/91→; -08/93; ⚙️ D2866LF05; 35A	8EL 725 644-001 Alternator	292
				09/91→; -04/92; ⚙️ D2866LF03; 55A	8EL 725 736-001 Alternator	294
				09/93→; -05/94; ⚙️ D2866LF05; 35A	8EL 731 715-001 Alternator	295
				09/93→; -05/94; ⚙️ D2866LF03; 35A	8EL 731 715-001 Alternator	295
				09/93→; -05/94; ⚙️ D2866LF15; 35A	8EL 731 715-001 Alternator	295
				09/91→; -05/94; ⚙️ D2866LF05; 80A	8EL 732 707-001 Alternator	295

Manufacturer - Model	Power	Displ.	Year of Constr.	Remark	Part Number	Page
MAN - F 90				07/86→12/97		
33.372 DFS	272 kW		09/91→06/96	09/91→; -05/94; ☺ D2866LF03; 80A	8EL 732 707-001 Alternator	295
				09/91→; -05/94; ☺ D2866LF15; 80A	8EL 732 707-001 Alternator	295
33.422 DF 33.422 DFA	309 kW		09/91→06/96	09/91→; -08/93; ☺ D2866LF09; 35A	8EL 725 644-001 Alternator	292
				09/91→; -08/93; ☺ D2866LF06; 35A	8EL 725 644-001 Alternator	292
	309 kW		09/91→06/96	09/91→; -04/92; ☺ D2866LF06; 55A	8EL 725 736-001 Alternator	294
				09/93→; -06/96; ☺ D2866LF09; 35A	8EL 731 715-001 Alternator	295
				09/93→; -06/96; ☺ D2866LF06; 35A	8EL 731 715-001 Alternator	295
				☺ D2866LF06; 80A	8EL 732 707-001 Alternator	295
				☺ D2866LF09; 80A	8EL 732 707-001 Alternator	295
33.422 DFAK 33.422 DFK 33.422 DFS	309 kW		01/94→06/96	☺ D2866LF06; 35A	8EL 731 715-001 Alternator	295
				☺ D2866LF09; 35A	8EL 731 715-001 Alternator	295
	309 kW		01/94→06/96	☺ D2866LF06; 80A	8EL 732 707-001 Alternator	295
				☺ D2866LF09; 80A	8EL 732 707-001 Alternator	295
35.292 VF 35.292 VFK	213 kW		10/88→04/95	☺ D2866LFZ/290; 35A	8EL 725 644-001 Alternator	292
				☺ D2866LFZ/290; 55A	8EL 725 736-001 Alternator	294
35.322 VFAK	235 kW		02/90→06/96	02/90→; -08/93; ☺ D2865LF06; 35A	8EL 725 644-001 Alternator	292
				02/90→; -08/93; ☺ D2865LF03; 35A	8EL 725 644-001 Alternator	292
				07/93→; -06/96; ☺ D2865LF06; 55A	8EL 725 736-001 Alternator	294
				07/93→; -06/96; ☺ D2865LF03; 55A	8EL 725 736-001 Alternator	294
				09/93→; -06/96; ☺ D2865LF03; 35A	8EL 731 715-001 Alternator	295
				09/93→; -06/96; ☺ D2865LF06; 35A	8EL 731 715-001 Alternator	295
				☺ D2865LF06; 80A	8EL 732 707-001 Alternator	295
				☺ D2865LF03; 80A	8EL 732 707-001 Alternator	295
35.322 VFK	235 kW		02/90→06/96	02/90→; -08/93; ☺ D2865LF03; 35A	8EL 725 644-001 Alternator	292
				02/90→; -08/93; ☺ D2865LF06; 35A	8EL 725 644-001 Alternator	292
				10/92→; -08/93; ☺ D2865LF03; 35A	8EL 725 644-001 Alternator	292
				10/92→; -08/93; ☺ D2865LF06; 35A	8EL 725 644-001 Alternator	292
				07/93→; -06/96; ☺ D2865LF06; 55A	8EL 725 736-001 Alternator	294
				07/93→; -06/96; ☺ D2865LF03; 55A	8EL 725 736-001 Alternator	294
				09/93→; -06/96; ☺ D2865LF03; 35A	8EL 731 715-001 Alternator	295
				09/93→; -06/96; ☺ D2865LF06; 35A	8EL 731 715-001 Alternator	295
				10/92→; -06/96; ☺ D2865LF06; 80A	8EL 732 707-001 Alternator	295
				10/92→; -06/96; ☺ D2865LF03; 80A	8EL 732 707-001 Alternator	295
				☺ D2865LF03; 80A	8EL 732 707-001 Alternator	295
				☺ D2865LF06; 80A	8EL 732 707-001 Alternator	295
35.332 VF 35.332 VFK	243 kW		10/88→04/95	☺ D2866LFZ/330; 35A	8EL 725 644-001 Alternator	292
				☺ D2866LFZ/330; 55A	8EL 725 736-001 Alternator	294

Manufacturer - Model	Power	Displ.	Year of Constr.	Remark	Part Number	Page
MAN - F 90					07/86→12/97	
35.372 VF	272 kW		02/90→06/96	02/90→; -08/93; ☉ D2866LF15; 35A	8EL 725 644-001 Alternator	292
				02/90→; -08/93; ☉ D2866LF05; 35A	8EL 725 644-001 Alternator	292
				02/90→; -08/93; ☉ D2866LF03; 35A	8EL 725 644-001 Alternator	292
				02/90→; -04/94; ☉ D2866LF15; 55A	8EL 725 736-001 Alternator	294
				02/90→; -04/92; ☉ D2866LF05; 55A	8EL 725 736-001 Alternator	294
				02/90→; -04/92; ☉ D2866LF03; 55A	8EL 725 736-001 Alternator	294
				09/93→; -05/94; ☉ D2866LF03; 35A	8EL 731 715-001 Alternator	295
				09/93→; -05/94; ☉ D2866LF05; 35A	8EL 731 715-001 Alternator	295
				09/93→; -05/94; ☉ D2866LF15; 35A	8EL 731 715-001 Alternator	295
				02/90→; -05/94; ☉ D2866LF15; 80A	8EL 732 707-001 Alternator	295
				02/90→; -05/94; ☉ D2866LF05; 80A	8EL 732 707-001 Alternator	295
				02/90→; -05/94; ☉ D2866LF03; 80A	8EL 732 707-001 Alternator	295
35.372 VFK	272 kW		02/90→06/96	02/90→; -08/93; ☉ D2866LF05; 35A	8EL 725 644-001 Alternator	292
				02/90→; -08/93; ☉ D2866LF03; 35A	8EL 725 644-001 Alternator	292
				02/90→; -04/92; ☉ D2866LF03; 55A	8EL 725 736-001 Alternator	294
				09/93→; -06/96; ☉ D2866LF05; 35A	8EL 731 715-001 Alternator	295
				09/93→; -06/96; ☉ D2866LF15; 35A	8EL 731 715-001 Alternator	295
				09/93→; -06/96; ☉ D2866LF03; 35A	8EL 731 715-001 Alternator	295
				☉ D2866LF03; 80A	8EL 732 707-001 Alternator	295
				☉ D2866LF05; 80A	8EL 732 707-001 Alternator	295
				☉ D2866LF15; 80A	8EL 732 707-001 Alternator	295
35.372 VFK	272 kW		02/90→12/97	02/90→; -08/93; ☉ D2866LF05; 35A	8EL 725 644-001 Alternator	292
				02/90→; -08/93; ☉ D2866LF03; 35A	8EL 725 644-001 Alternator	292
				02/90→; -04/92; ☉ D2866LF03; 55A	8EL 725 736-001 Alternator	294
				09/93→; -06/96; ☉ D2866LF05; 35A	8EL 731 715-001 Alternator	295
				09/93→; -06/96; ☉ D2866LF03; 35A	8EL 731 715-001 Alternator	295
				09/93→; -06/96; ☉ D2866LF15; 35A	8EL 731 715-001 Alternator	295
				02/90→; -06/96; ☉ D2866LF15; 80A	8EL 732 707-001 Alternator	295
				02/90→; -06/96; ☉ D2866LF05; 80A	8EL 732 707-001 Alternator	295
				02/90→; -06/96; ☉ D2866LF03; 80A	8EL 732 707-001 Alternator	295
35.402 VF 35.402 VFK	294 kW 294 kW		05/94→12/97 05/94→12/97	05/94→; -06/96; ☉ D2866LF16; 35A	8EL 731 715-001 Alternator	295
				05/94→; -06/96; ☉ D2866LF16; 80A	8EL 732 707-001 Alternator	295
35.422 VF 35.422 VF 35.422 VFK	309 kW 309 kW 309 kW		02/90→06/96 02/90→12/97 02/90→06/96	02/90→; -08/93; ☉ D2866LF09; 35A	8EL 725 644-001 Alternator	292
				02/90→; -08/93; ☉ D2866LF06; 35A	8EL 725 644-001 Alternator	292
				02/90→; -04/92; ☉ D2866LF06; 55A	8EL 725 736-001 Alternator	294
				02/90→; -04/92; ☉ D2866LF09; 55A	8EL 725 736-001 Alternator	294
				09/93→; -05/94; ☉ D2866LF09; 35A	8EL 731 715-001 Alternator	295

Manufacturer - Model	Power	Displ.	Year of Constr.	Remark	Part Number	Page
MAN - F 90					07/86→12/97	
35.422 VF	309 kW		02/90→06/96	09/93→; -05/94; ☺ D2866LF06; 35A	8EL 731 715-001	295
35.422 VF	309 kW		02/90→12/97		Alternator	
35.422 VFK	309 kW		02/90→06/96	02/90→; -05/94; ☺ D2866LF06; 80A	8EL 732 707-001	295
					Alternator	
				02/90→; -05/94; ☺ D2866LF09; 80A	8EL 732 707-001	295
					Alternator	
35.422 VFK	309 kW		02/90→12/97	10/92→; -08/93; ☺ D2866LF06; 35A	8EL 725 644-001	292
					Alternator	
				10/92→; -08/93; ☺ D2866LF09; 35A	8EL 725 644-001	292
					Alternator	
				09/93→; -06/96; ☺ D2866LF09; 35A	8EL 731 715-001	295
					Alternator	
				09/93→; -06/96; ☺ D2866LF06; 35A	8EL 731 715-001	295
					Alternator	
				10/92→; -06/96; ☺ D2866LF06; 80A	8EL 732 707-001	295
					Alternator	
				10/92→; -06/96; ☺ D2866LF09; 80A	8EL 732 707-001	295
					Alternator	
40.372 DF	272 kW		12/91→06/96	12/91→; -08/93; ☺ D2866LF05; 35A	8EL 725 644-001	292
40.372 DFA	272 kW		12/91→06/96		Alternator	
				12/91→; -08/93; ☺ D2866LF03; 35A	8EL 725 644-001	292
					Alternator	
				12/91→; -04/92; ☺ D2866LF03; 55A	8EL 725 736-001	294
					Alternator	
				09/93→; -06/96; ☺ D2866LF05; 35A	8EL 731 715-001	295
					Alternator	
				09/93→; -06/96; ☺ D2866LF15; 35A	8EL 731 715-001	295
					Alternator	
				☺ D2866LF03; 80A	8EL 732 707-001	295
					Alternator	
				☺ D2866LF05; 80A	8EL 732 707-001	295
					Alternator	
				☺ D2866LF15; 80A	8EL 732 707-001	295
					Alternator	
40.422 DF	309 kW		12/91→06/96	12/91→; -08/93; ☺ D2866LF06; 35A	8EL 725 644-001	292
40.422 DFA	309 kW		12/91→06/96		Alternator	
				12/91→; -08/93; ☺ D2866LF09; 35A	8EL 725 644-001	292
					Alternator	
				12/91→; -04/92; ☺ D2866LF06; 55A	8EL 725 736-001	294
					Alternator	
				09/93→; -06/96; ☺ D2866LF09; 35A	8EL 731 715-001	295
					Alternator	
				09/93→; -06/96; ☺ D2866LF06; 35A	8EL 731 715-001	295
					Alternator	
				☺ D2866LF06; 80A	8EL 732 707-001	295
					Alternator	
				☺ D2866LF09; 80A	8EL 732 707-001	295
					Alternator	
41.322 VF	235 kW		02/90→06/96	02/90→; -08/93; ☺ D2865LF06; 35A	8EL 725 644-001	292
					Alternator	
				02/90→; -05/94; ☺ D2865LF03; 35A	8EL 725 644-001	292
					Alternator	
				02/90→; -05/94; ☺ D2865LF03; 55A	8EL 725 736-001	294
					Alternator	
				☺ D2865LF06; 55A	8EL 725 736-001	294
					Alternator	
				09/93→; -05/94; ☺ D2865LF03; 35A	8EL 731 715-001	295
					Alternator	
				☺ D2865LF06; 80A	8EL 732 707-001	295
					Alternator	
				02/90→; -05/94; ☺ D2865LF03; 80A	8EL 732 707-001	295
					Alternator	
41.342 VF	250 kW		05/94→06/96	☺ D2865LF09; 55A	8EL 725 736-001	294
					Alternator	
				☺ D2865LF09; 80A	8EL 732 707-001	295
					Alternator	
41.372 VF	272 kW		02/90→06/96	02/90→; -05/94; ☺ D2866LF05; 35A	8EL 725 644-001	292
					Alternator	
				02/90→; -05/94; ☺ D2866LF03; 35A	8EL 725 644-001	292
					Alternator	
				10/92→; -05/94; ☺ D2866LF05; 55A	8EL 725 736-001	294
					Alternator	
				02/90→; -04/92; ☺ D2866LF03; 55A	8EL 725 736-001	294
					Alternator	

Manufacturer - Model	Power	Displ.	Year of Constr.	Remark	Part Number	Page
MAN - F 90					07/86→12/97	
41.372 VF	272 kW		02/90→06/96	09/93→; →06/96; ☉ D2866LF05; 35A	8EL 731 715-001 Alternator	295
				09/93→; →06/96; ☉ D2866LF15; 35A	8EL 731 715-001 Alternator	295
				09/93→; →06/96; ☉ D2866LF03; 35A	8EL 731 715-001 Alternator	295
				☉ D2866LF03; 80A	8EL 732 707-001 Alternator	295
				☉ D2866LF05; 80A	8EL 732 707-001 Alternator	295
				☉ D2866LF15; 80A	8EL 732 707-001 Alternator	295
MAN - F 2000					01/94→	
19.233 FCNG	170 kW			09/96→; →12/01; ☉ E2866DF01; 55A	8EL 725 736-001 Alternator	294
				09/96→; →12/01; ☉ E2866DF01; 80A	8EL 732 707-001 Alternator	295
19.233 FKNG	170 kW			03/00→; ☉ E2866DF01; 55A	8EL 725 736-001 Alternator	294
19.273 F, FL, FLL	198 kW		01/94→	01/94→; →12/95; ☉ D2865LF22; 55A	8EL 725 736-001 Alternator	294
19.273 FA	198 kW		01/94→			
19.273 FAK	198 kW		01/94→	01/94→; →12/95; ☉ D2865LF22; 35A	8EL 731 715-001 Alternator	295
19.273 FK	198 kW		01/94→	01/94→; →12/95; ☉ D2865LF22; 80A	8EL 732 707-001 Alternator	295
19.273 FS, 19.273 FLS	198 kW		01/94→12/95	☉ D2865LF22; 55A	8EL 725 736-001 Alternator	294
24.273 FNLLC	198 kW		01/94→12/95			
26.273 DFC, 26.273 DFLC	198 kW		01/94→12/95	☉ D2865LF22; 35A	8EL 731 715-001 Alternator	295
26.273 DFK, 26.273 DFLK	198 kW		01/94→12/95			
26.273 DFS, 26.273 DFLS	198 kW		01/94→12/95	☉ D2865LF22; 80A	8EL 732 707-001 Alternator	295
26.273 FNLC, 26.273 FNLLC,	198 kW		01/94→12/95			
26.273 FVLC						
26.273 FNLS, 26.273 FVLS	198 kW		01/94→12/95			
27.273 DFC	198 kW		01/94→12/95			
27.273 DFAK	198 kW		01/94→12/95			
27.273 DFAS	198 kW		01/94→12/95			
27.273 DFC	198 kW		01/94→12/95			
27.273 DFK	198 kW		01/94→12/95			
27.273 DFS	198 kW		01/94→12/95			
19.293 FAC	213 kW		01/94→	04/95→; →09/01; ☉ D2865LF24; 55A	8EL 725 736-001 Alternator	294
19.293 FAK	213 kW		01/94→			
19.293 FAS	213 kW		01/94→	01/94→; →09/01; ☉ D2865LF20; 55A	8EL 725 736-001 Alternator	294
19.293 FC, 19.293 FLC, 19.293 FLLC	213 kW		01/94→			
19.293 FK, 19.293 FLK	213 kW		01/94→	01/94→; →09/01; ☉ D2865LF20; 35A	8EL 731 715-001 Alternator	295
19.293 FS, 19.293 FLS, 19.293 FLLS	213 kW		01/94→	04/95→; →09/01; ☉ D2865LF24; 35A	8EL 731 715-001 Alternator	295
26.293 DFC, 26.293 DFLC	213 kW		01/94→			
26.293 DFK, 26.293 DFLK	213 kW		01/94→	04/95→; →09/01; ☉ D2865LF24; 80A	8EL 732 707-001 Alternator	295
26.293 DFS, 26.293 DFLS	213 kW		01/94→			
26.293 FNLC, 26.293 FNLLC,	213 kW		01/94→	01/94→; →09/01; ☉ D2865LF20; 80A	8EL 732 707-001 Alternator	295
26.293 FVLC						
26.293 FNLS, 26.293 FVLS	213 kW		01/94→			
27.293 DFC	213 kW		01/94→			
27.293 DFAK	213 kW		01/94→			
27.293 DFAS	213 kW		01/94→			
27.293 DFC	213 kW		01/94→			
27.293 DFK	213 kW		01/94→			
27.293 DFS	213 kW		01/94→			
19.314 FAC	228 kW		05/01→	55A	8EL 725 736-001 Alternator	294
19.314 FAK, FA-KI	228 kW		05/01→			
23.314 FNLLC	228 kW		05/01→			
23.364 FNLLC	265 kW		05/01→			
24.314 FNLLRC	228 kW		05/01→			
24.364 FNLLRC	265 kW		05/01→			
24.414 FNLLRC	301 kW		05/01→			
24.464 FNLLRC	338 kW		05/01→			
26.233 FVL-KO	170 kW		03/00→			
26.314 DFC, DFLC	228 kW		05/01→			
27.314 DFAK, DFA-KI	228 kW		05/01→			
27.314 DFC	228 kW		05/01→			
27.314 DFK, DF-KI	228 kW		05/01→			
27.314 DFS	228 kW		05/01→			
27.314 DF-TM	228 kW		05/01→			
27.364 DFAK, DFA-KI	265 kW		05/01→			
27.364 DFAS	265 kW		05/01→			
27.364 DFC	265 kW		05/01→			

Manufacturer - Model	Power	Displ.	Year of Constr.	Remark	Part Number	Page			
MAN - F 2000						01/94→			
27.364 DFK, DF-KI	265 kW		05/01→	55A	8EL 725 736-001 Alternator	294			
27.364 DF-TM	265 kW		05/01→						
27.414 DFAK, DFA-KI	301 kW		05/01→						
27.414 DFAS	301 kW		05/01→						
27.414 DFC	301 kW		05/01→						
27.414 DFK, DF-KI	301 kW		05/01→						
27.414 DFS	301 kW		05/01→						
27.414 DF-TM	301 kW		05/01→						
27.463 DF-TM	338 kW		07/00→						
27.464 DFAK, DFA-KI	338 kW		05/01→						
27.464 DFAS	338 kW		05/01→						
27.464 DFK, DF-KI	338 kW		05/01→						
27.464 DF-TM	338 kW		05/01→						
33.364 DFAC	265 kW		05/01→						
33.364 DFAK, DFA-KI	265 kW		05/01→						
33.364 DFAS	265 kW		05/01→						
33.364 DFC	265 kW		05/01→						
33.364 DFK, DF-KI	265 kW		05/01→						
33.364 DFS, DFRS	265 kW		05/01→						
33.414 DFAC	301 kW		05/01→						
33.414 DFAK, DFA-KI	301 kW		05/01→						
33.414 DFAS	301 kW		05/01→						
33.414 DFC	301 kW		05/01→						
33.414 DFK, DF-KI	301 kW		05/01→						
33.414 DFS, DFRS	301 kW		05/01→						
33.464 DFAC	338 kW		05/01→						
33.464 DFAK, DFA-KI	338 kW		05/01→						
33.464 DFAS	338 kW		05/01→						
33.464 DFC	338 kW		05/01→						
33.464 DFK, DF-KI	338 kW		05/01→						
33.464 DFS, DFRS	338 kW		05/01→						
35.314 VF-TM	228 kW		03/02→						
40.414 DFAK	301 kW		05/01→						
40.414 DFK	301 kW		05/01→						
41.364 VF, VFC, VFRC	265 kW		05/01→						
41.364 VFK, VF-HK, VF-KI	265 kW		03/02→						
41.414 VF, VFC, VFRC	301 kW		05/01→						
41.414 VFK, VF-HK, VF-KI	301 kW		03/02→						
41.464 VFK, VF-HK, VF-KI	338 kW		03/02→						
19.314 FAS	228 kW		06/98→				06/98→; →12/01; ⚠ D2866LF34; 55A	8EL 725 736-001 Alternator	294
19.314 FC, FLC, FLLC, FLLW, FRC, FLRC, FLLRC, FLL, FLLR, F-N	228 kW		06/98→						
19.314 FK, FLK, F-KI, FL-KI	228 kW		06/98→	06/98→; →12/01; ⚠ D2866LF34; 35A	8EL 731 715-001 Alternator	295			
19.314 FS, FLS, FLLS, FRS, FLRS, FLLRS	228 kW		06/98→	06/98→; →12/01; ⚠ D2866LF34; 80A	8EL 732 707-001 Alternator	295			
				06/98→; →12/01; ⚠ D2866LF34; 90A	8EL 737 985-001 Alternator	296			
				06/98→; →12/01; ⚠ D2866LF34; 55A	8EL 738 055-001 Alternator	297			
19.323 FAC	235 kW		01/94→12/95	⚠ D2865LF23; 55A	8EL 725 736-001 Alternator	294			
19.323 FAK	235 kW		01/94→12/95						
19.323 FAS	235 kW		01/94→12/95						
19.323 FC, 19.323 FLC, 19.323 FLLC	235 kW		01/94→12/95						
19.323 FK, 19.323 FLK	235 kW		01/94→12/95	⚠ D2865LF23; 35A	8EL 731 715-001 Alternator	295			
19.323 FS, 19.323 FLS, 19.323 FLLS	235 kW		01/94→12/95						
24.323 FNLLC	235 kW		01/94→12/95	⚠ D2865LF23; 80A	8EL 732 707-001 Alternator	295			
26.323 DFC, 26.323 DFLC	235 kW		01/94→12/95						
26.323 DFK, 26.323 DFLK	235 kW		01/94→12/95						
26.323 DFS, 26.323 DFSL	235 kW		01/94→12/95						
26.323 FNLC, 26.323 FNLLC,	235 kW		01/94→12/95						
26.323 FVLC									
26.323 FNLS, 26.323 FVLS	235 kW		01/94→12/95						
27.323 DFAC	235 kW		01/94→12/95						
27.323 DFAS	235 kW		01/94→12/95						
27.323 DFC	235 kW		01/94→12/95						
27.323 DFS	235 kW		01/94→12/95						
33.323 DFAC	235 kW		01/94→12/95						
33.323 DFAK	235 kW		01/94→12/95						
33.323 DFAS	235 kW		01/94→12/95						
33.323 DFC	235 kW		01/94→12/95						
33.323 DFK	235 kW		01/94→12/95						
33.323 DFS	235 kW		01/94→12/95						
19.343 FAC	250 kW		01/94→				01/94→; →09/01; ⚠ D2865LF21; 55A	8EL 725 736-001 Alternator	294
19.343 FAK	250 kW		01/94→						
19.343 FAS	250 kW		01/94→				01/94→; →09/01; ⚠ D2865LF21; 35A	8EL 731 715-001 Alternator	295
19.343 FC, 19.343 FLC, 19.343 FLLC	250 kW		01/94→						
19.343 FK, 19.343 FLK	250 kW		01/94→						

Manufacturer - Model	Power	Displ.	Year of Constr.	Remark	Part Number	Page
MAN - F 2000						01/94→
19.343 FS,19.343 FLS,19.343 FLLS	250 kW		01/94→	01/94→; →09/01; ⚡ D2866LF21: 80A	8EL 732 707-001 Alternator	295
26.343 DFC,26.343 DFLC	250 kW		01/94→			
26.343 DFK,26.343 DFLK	250 kW		01/94→			
26.343 DFS,26.343 DFLS	250 kW		01/94→			
26.343 FNLC,26.343 FNLLC, 26.343 FVLC	250 kW		01/94→			
26.343 FNLS,26.343 FVLS	250 kW		01/94→			
27.343 DFAC	250 kW		01/94→			
27.343 DFAS	250 kW		01/94→			
27.343 DFC	250 kW		01/94→			
27.343 DFK	250 kW		01/94→			
27.343 DFS	250 kW		01/94→			
33.343 DFAC	250 kW		01/94→			
33.343 DFAK	250 kW		01/94→			
33.343 DFAS	250 kW		01/94→			
33.343 DFC	250 kW		01/94→			
33.343 DFK	250 kW		01/94→			
33.343 DFS	250 kW		01/94→			
19.364 FAC	265 kW		06/98→	06/98→; →12/01; ⚡ D2866LF35: 55A	8EL 725 736-001 Alternator	294
19.364 FAK, FA-KI	265 kW		06/98→			
19.364 FAS	265 kW		06/98→	06/98→; →12/01; ⚡ D2866LF35: 35A	8EL 731 715-001 Alternator	295
19.364 FC, FLC, FLLC, FLLW, FRC, FLRC, FLLRC, FLL, FLLR, F-N	265 kW		06/98→			
19.364 FK, FLK, F-KI, FL-KI	265 kW		06/98→	06/98→; →12/01; ⚡ D2866LF35: 80A	8EL 732 707-001 Alternator	295
19.364 FS, FLS, FLLS, FRS, FLRS, FLLRS	265 kW		06/98→	06/98→; →12/01; ⚡ D2866LF35: 90A	8EL 737 985-001 Alternator	296
				06/98→; →12/01; ⚡ D2866LF35: 55A	8EL 738 055-001 Alternator	297
19.373 FAC	272 kW		01/94→	01/94→; →12/95; ⚡ D2866LF21: 55A	8EL 725 736-001 Alternator	294
19.373 FAK, FA-KI	272 kW		01/94→			
19.373 FAS	272 kW		01/94→	01/94→; →12/95; ⚡ D2866LF21: 35A	8EL 731 715-001 Alternator	295
19.373 FC, FLC, FLLC, FRC, FLRC, F-NL	272 kW		01/94→			
19.373 FK, FLK, F-KI, FL-KI	272 kW		01/94→	01/94→; →12/95; ⚡ D2866LF21: 80A	8EL 732 707-001 Alternator	295
19.373 FS, FLS, FLLS, FRS, FLRS, FLLRS	272 kW		01/94→			
19.403 FAC	294 kW		01/94→	01/94→; →09/01; ⚡ D2866LF20: 55A	8EL 725 736-001 Alternator	294
19.403 FAK, FA-KI	294 kW		01/94→			
19.403 FAS	294 kW		01/94→	01/94→; →09/01; ⚡ D2866LF20: 35A	8EL 731 715-001 Alternator	295
19.403 FC, FLC, FLLC, FRC, FLRC, F-NL	294 kW		01/94→			
19.403 FK, FLK, F-KI, FL-KI	294 kW		01/94→	01/94→; →09/01; ⚡ D2866LF20: 80A	8EL 732 707-001 Alternator	295
19.403 FS, FLS, FLLS, FRS, FLRS, FLLRS	294 kW		01/94→	01/94→; →09/01; ⚡ D2866LF20: 90A	8EL 737 985-001 Alternator	296
24.403 FNLLC	294 kW		01/94→			
26.403 DFC,26.403 DFLC	294 kW		01/94→	01/94→; →09/01; ⚡ D2866LF20: 55A	8EL 738 055-001 Alternator	297
26.403 DFK,26.403 DFLK	294 kW		01/94→			
26.403 DFS,26.403 DFLS	294 kW		01/94→			
26.403 FNLC,26.403 FNLLC, 26.403 FVLC	294 kW		01/94→			
26.403 FNLS,26.403 FVLS	294 kW		01/94→			
27.403 DFAC	294 kW		01/94→			
27.403 DFAS	294 kW		01/94→			
27.403 DFC	294 kW		01/94→			
27.403 DFK, DF-KI	294 kW		01/94→			
27.403 DFS	294 kW		01/94→			
33.403 DFAC	294 kW		01/94→			
33.403 DFAK, DFA-KI	294 kW		01/94→			
33.403 DFAS	294 kW		01/94→			
33.403 DFC	294 kW		01/94→			
33.403 DFK, DF-KI	294 kW		01/94→			
33.403 DFS, DFRS	294 kW		01/94→			
19.414 FAC	301 kW		06/98→	06/98→; →12/01; ⚡ D2866LF31: 55A	8EL 725 736-001 Alternator	294
19.414 FAK, FA-KI	301 kW		06/98→			
19.414 FAS	301 kW		06/98→	06/98→; →12/01; ⚡ D2866LF31: 35A	8EL 731 715-001 Alternator	295
19.414 FC, FLC, FLLC, FRC, FLRC, FLLRC, FLL, FLLR, F-NL	301 kW		06/98→			
19.414 FK, FLK, F-KI, FL-KI	301 kW		06/98→	06/98→; →12/01; ⚡ D2866LF31: 80A	8EL 732 707-001 Alternator	295
19.414 FS, FLS, FLLS, FRS, FLRS, FLLRS	301 kW		06/98→	06/98→; →12/01; ⚡ D2866LF31: 90A	8EL 737 985-001 Alternator	296
				06/98→; →12/01; ⚡ D2866LF31: 55A	8EL 738 055-001 Alternator	297

Manufacturer - Model	Power	Displ.	Year of Constr.	Remark	Part Number	Page
MAN - F 2000						01/94→
19.423 FAC	309 kW		01/94→12/95	☺ D2866LF22; 55A	8EL 725 736-001 Alternator	294
19.423 FAS	309 kW		01/94→12/95	☺ D2866LF22; 35A	8EL 731 715-001 Alternator	295
				☺ D2866LF22; 80A	8EL 732 707-001 Alternator	295
19.423 FAK, FA-KI	309 kW		01/94→	01/94→; →12/95; ☺ D2866LF22; 55A	8EL 725 736-001 Alternator	294
19.423 FK, FLK, F-KI, FL-KI	309 kW		01/94→			
27.423 DFAC	309 kW		01/94→	01/94→; →12/95; ☺ D2866LF22; 35A	8EL 731 715-001 Alternator	295
27.423 DFC	309 kW		01/94→			
27.423 DFK, DF-KI	309 kW		01/94→	01/94→; →12/95; ☺ D2866LF22; 80A	8EL 732 707-001 Alternator	295
27.423 DFS	309 kW		01/94→			
33.423 DFAC	309 kW		01/94→			
33.423 DFAK, DFA-KI	309 kW		01/94→	01/94→; →12/95; ☺ D2866LF22; 90A	8EL 737 985-001 Alternator	296
33.423 DFAS	309 kW		01/94→			
33.423 DFC	309 kW		01/94→	01/94→; →12/95; ☺ D2866LF22; 55A	8EL 738 055-001 Alternator	297
33.423 DFS, DFRS	309 kW		01/94→			
19.423 FC, FLC, FLLC, F-NL	309 kW		01/94→	01/94→; →12/95; ☺ D2866LF22; 55A	8EL 725 736-001 Alternator	294
19.423 FS, FLS, FLLS	309 kW		01/94→			
				01/94→; →12/95; ☺ D2866LF22; 35A	8EL 731 715-001 Alternator	295
				01/94→; →12/95; ☺ D2866LF22; 80A	8EL 732 707-001 Alternator	295
19.463 FAC	338 kW		01/94→	01/94→; →09/01; ☺ D2876LF02; 55A	8EL 725 736-001 Alternator	294
19.463 FAK, FA-KI	338 kW		01/94→			
19.463 FAS	338 kW		01/94→	01/94→; →09/01; ☺ D2876LF02; 80A	8EL 732 707-001 Alternator	295
19.463 FC, FLC, FLLC, FRC, FLRC, F-NL	338 kW		01/94→			
19.463 FK, FLK, F-KI, FL-KI	338 kW		01/94→	01/94→; →09/01; ☺ D2876LF02; 90A	8EL 737 985-001 Alternator	296
19.463 FS, FLS, FLLS, FRS, FLRS, FLLRS	338 kW		01/94→	01/94→; →09/01; ☺ D2876LF02; 55A	8EL 738 055-001 Alternator	297
23.463 FNLLC	338 kW		01/94→			
24.463 FNLLC	338 kW		01/94→			
26.463 DFC, DFCLC	338 kW		01/94→			
26.463 DFK,26.463 DFLK	338 kW		01/94→			
26.463 DFS,26.463 DFSL	338 kW		01/94→			
26.463 FNLC, FNLLC, FVLC	338 kW		01/94→			
26.463 FNLS,26.463 FVLS	338 kW		01/94→			
19.464 FAC	338 kW		06/98→	☺ D2876LF06; 55A	8EL 725 736-001 Alternator	294
27.464 DFS	338 kW		01/94→			
41.464 VF, VFC, VFRC	338 kW		06/98→			
19.464 FAK, FA-KI	338 kW		06/98→	06/98→; →07/01; ☺ D2876LF06; 55A	8EL 725 736-001 Alternator	294
19.464 FAS	338 kW		06/98→			
19.464 FC, FLC, FLLC, FLL, FRC, FLLR, FLLRC, FLLW, F-NL	338 kW		06/98→	06/98→; →07/01; ☺ D2876LF06; 35A	8EL 731 715-001 Alternator	295
19.464 FK, FLK, F-KI, FL-KI	338 kW		06/98→	06/98→; →07/01; ☺ D2876LF06; 80A	8EL 732 707-001 Alternator	295
19.464 FS, FLS, FLLS, FRS, FLRS, FLLRS	338 kW		06/98→	06/98→; →07/01; ☺ D2876LF06; 90A	8EL 737 985-001 Alternator	296
				06/98→; →07/01; ☺ D2876LF06; 55A	8EL 738 055-001 Alternator	297
23.293 FNLLC	213 kW		01/94→	01/94→; →01/00; ☺ D2865LF20; 55A	8EL 725 736-001 Alternator	294
				04/95→; →01/00; ☺ D2865LF24; 55A	8EL 725 736-001 Alternator	294
				04/95→; →01/00; ☺ D2865LF24; 35A	8EL 731 715-001 Alternator	295
				01/94→; →01/00; ☺ D2865LF20; 35A	8EL 731 715-001 Alternator	295
				04/95→; →01/00; ☺ D2865LF24; 80A	8EL 732 707-001 Alternator	295
				01/94→; →01/00; ☺ D2865LF20; 80A	8EL 732 707-001 Alternator	295
23.343 FNLLC	250 kW		01/94→	01/94→; →01/00; ☺ D2865LF21; 55A	8EL 725 736-001 Alternator	294
24.343 FNLLC	250 kW		01/94→			
				01/94→; →01/00; ☺ D2865LF21; 35A	8EL 731 715-001 Alternator	295
				01/94→; →01/00; ☺ D2865LF21; 80A	8EL 732 707-001 Alternator	295

Manufacturer - Model	Power	Displ.	Year of Constr.	Remark	Part Number	Page
MAN - F 2000						01/94→
23.403 FNLLC	294 kW		01/94→	01/94→; →09/00; ☼ D2866LF20; 55A	8EL 725 736-001 Alternator	294
				01/94→; →09/00; ☼ D2866LF20; 35A	8EL 731 715-001 Alternator	295
				01/94→; →09/00; ☼ D2866LF20; 80A	8EL 732 707-001 Alternator	295
				01/94→; →09/00; ☼ D2866LF20; 90A	8EL 737 985-001 Alternator	296
				01/94→; →09/00; ☼ D2866LF20; 55A	8EL 738 055-001 Alternator	297
24.293 FNLLC	213 kW		01/94→	01/94→; →01/00; ☼ D2865LF24; 55A	8EL 725 736-001 Alternator	294
				01/94→; →01/00; ☼ D2865LF24; 35A	8EL 731 715-001 Alternator	295
				01/94→; →01/00; ☼ D2865LF24; 80A	8EL 732 707-001 Alternator	295
24.373 FNLLC 26.373 DFC,26.373 DFLLC 26.373 DFK,26.373 DFLK 26.373 DFS,26.373 DFLLS 26.373 FNLC,26.373 FNLLC, 26.373 FVLC 26.373 FNLS,26.373 FVLS	272 kW 272 kW 272 kW 272 kW 272 kW 272 kW		01/94→12/95 01/94→12/95 01/94→12/95 01/94→12/95 01/94→12/95 01/94→12/95	☼ D2866LF21; 55A	8EL 725 736-001 Alternator	294
				☼ D2866LF21; 35A	8EL 731 715-001 Alternator	295
				☼ D2866LF21; 80A	8EL 732 707-001 Alternator	295
				☼ D2866LF22; 55A	8EL 725 736-001 Alternator	294
				☼ D2866LF22; 35A	8EL 731 715-001 Alternator	295
				☼ D2866LF22; 80A	8EL 732 707-001 Alternator	295
24.423 FNLLC 26.423 DFC,26.423 DFLLC 26.423 DFK,26.423 DFLK 26.423 DFS,26.423 DFLLS 26.423 FNLC,26.423 FNLLC, 26.423 FVLC 26.423 FNLS,26.423 FVLS 27.423 DFAS	309 kW 309 kW 309 kW 309 kW 309 kW 309 kW 309 kW		01/94→12/95 01/94→12/95 01/94→12/95 01/94→12/95 01/94→12/95 01/94→12/95 01/94→12/95	☼ D2866LF22; 55A	8EL 725 736-001 Alternator	294
				☼ D2866LF22; 35A	8EL 731 715-001 Alternator	295
				☼ D2866LF22; 80A	8EL 732 707-001 Alternator	295
				☼ D2866LF22; 90A	8EL 737 985-001 Alternator	296
				☼ D2866LF22; 55A	8EL 738 055-001 Alternator	297
26.233 FVL CNG	170 kW		09/96→	09/96→; →08/02; ☼ E2866DF01; 55A	8EL 725 736-001 Alternator	294
				09/96→; →08/02; ☼ E2866DF01; 80A	8EL 732 707-001 Alternator	295
26.314 DFK, DFLK 26.314 DFS, DFLLS 26.314 DF-TM 26.314 FNLC, FNLLC, FNLLRC, FNLLW, FVLC 26.314 FNLS 26.314 FVL-KO 26.314 FVLS, FVLRS 27.314 DFAC 27.314 FVL 32.314 VF, VFC 32.314 VFK, VF-HK 32.314 VF-TM	228 kW 228 kW 228 kW 228 kW 228 kW 228 kW 228 kW 228 kW 228 kW 228 kW 228 kW 228 kW 228 kW		05/01→ 05/01→ 05/01→ 05/01→ 05/01→ 05/01→ 05/01→ 05/01→ 06/98→ 05/01→ 05/01→ 05/01→ 05/01→ 05/01→	☼ D2866LF23; 90A	8EL 737 985-001 Alternator	296
26.364 DFC, DFLLC 26.364 DFK, DFLK 26.364 DFS, DFLLS 26.364 DF-TM 26.364 FNLC, FNLLC, FNLLRC, FNLLW, FVLC 26.364 FNLS 26.364 FVL-KO 26.364 FVLS, FVLRS 27.364 DFAC 27.364 FVL 32.364 VF, VFC 32.364 VFK, VF-HK 32.364 VF-TM 35.364 VF, VFC, VFRC 35.364 VFK, VF-HK, VF-KI 35.364 VF-TM	265 kW 265 kW 265 kW 265 kW 265 kW 265 kW 265 kW 265 kW 265 kW 265 kW 265 kW 265 kW 265 kW 265 kW		05/01→ 05/01→ 05/01→ 05/01→ 05/01→ 05/01→ 05/01→ 05/01→ 05/01→ 06/98→ 05/01→ 05/01→ 05/01→ 03/02→ 03/02→	☼ D2866LF24; 90A	8EL 737 985-001 Alternator	296
26.414 DFC, DFLLC 26.414 DFK, DFLK 26.414 DFS, DFLLS 26.414 DF-TM 26.414 FNLC, FNLLC, FNLLRC, FNLLW, FVLC 26.414 FNLS 26.414 FVL-KO 26.414 FVLS, FVLRS 27.414 DFAC	301 kW 301 kW 301 kW 301 kW 301 kW 301 kW 301 kW 301 kW 301 kW		05/01→ 05/01→ 05/01→ 05/01→ 05/01→ 05/01→ 05/01→ 05/01→ 05/01→	☼ D2866LF25; 90A	8EL 737 985-001 Alternator	296

Manufacturer - Model	Power	Displ.	Year of Constr.	Remark	Part Number	Page
MAN - F 2000						01/94→
27.414 FVL	301 kW		06/98→	☺ D2866LF25; 90A	8EL 737 985-001 Alternator	296
32.414 VF, VFC	301 kW		05/01→			
32.414 VFK, VF-HK	301 kW		05/01→			
32.414 VF-TM	301 kW		05/01→			
35.414 VF, VFC, VFRC	301 kW		05/01→			
35.414 VFK, VF-HK, VF-KI	301 kW		03/02→			
35.414 VF-TM	301 kW		03/02→			
37.414 VFA	301 kW		06/98→			
26.464 DFC, DFLC	338 kW		05/01→	☺ D2876LF03; 90A	8EL 737 985-001 Alternator	296
26.464 DFK, DFLK	338 kW		05/01→			
26.464 DFS, DFSL	338 kW		05/01→			
26.464 DF-TM	338 kW		05/01→			
26.464 FNLC, FNLLC, FNLLW, FVLC	338 kW		05/01→			
26.464 FNLS	338 kW		05/01→			
26.464 FVL-KO	338 kW		05/01→			
26.464 FVLS, FVLRS	338 kW		05/01→			
27.464 DFAC	338 kW		05/01→			
27.464 FVL	338 kW		06/98→			
32.464 VF, VFC	338 kW		05/01→			
32.464 VFK, VF-HK	338 kW		05/01→			
32.464 VF-TM	338 kW		05/01→			
35.464 VF, VFC, VFRC	338 kW		05/01→			
35.464 VFK, VF-HK, VF-KI	338 kW		03/02→			
35.464 VF-TM	338 kW		03/02→			
27.323 DFAK, DFA-KI	235 kW		01/94→	01/94→; -12/95; ☺ D2865LF23; 55A	8EL 725 736-001 Alternator	294
27.323 DFK, DF-KI	235 kW		01/94→			
				01/94→; -12/95; ☺ D2865LF23; 35A	8EL 731 715-001 Alternator	295
				01/94→; -12/95; ☺ D2865LF23; 80A	8EL 732 707-001 Alternator	295
27.343 DFAK	250 kW		01/94→	☺ D2865LF21; 55A	8EL 725 736-001 Alternator	294
27.373 DFAC	272 kW		01/94→	01/94→; -12/95; ☺ D2866LF21; 55A	8EL 725 736-001 Alternator	294
27.373 DFAK, DFA-KI	272 kW		01/94→			
27.373 DFAS	272 kW		01/94→	01/94→; -12/95; ☺ D2866LF21; 35A	8EL 731 715-001 Alternator	295
27.373 DFC	272 kW		01/94→			
27.373 DFK, DF-KI	272 kW		01/94→	01/94→; -12/95; ☺ D2866LF21; 80A	8EL 732 707-001 Alternator	295
27.373 DFS	272 kW		01/94→			
33.373 DFAC	272 kW		01/94→	01/94→; -12/95; ☺ D2866LF21; 90A	8EL 737 985-001 Alternator	296
33.373 DFAK, DFA-KI	272 kW		01/94→			
33.373 DFC	272 kW		01/94→			
33.373 DFK, DF-KI	272 kW		01/94→	01/94→; -12/95; ☺ D2866LF21; 55A	8EL 738 055-001 Alternator	297
33.373 DFS, DFRS	272 kW		01/94→			
27.463 DFAC	338 kW		01/94→	01/94→; -09/01; ☺ D2876LF02; 55A	8EL 725 736-001 Alternator	294
27.463 DFAK, DFA-KI	338 kW		01/94→			
27.463 DFAS	338 kW		01/94→	01/94→; -09/01; ☺ D2876LF02; 35A	8EL 731 715-001 Alternator	295
27.463 DFC	338 kW		01/94→			
27.463 DFK, DF-KI	338 kW		01/94→	01/94→; -09/01; ☺ D2876LF02; 80A	8EL 732 707-001 Alternator	295
27.463 DFS	338 kW		01/94→			
33.463 DFAC	338 kW		01/94→	01/94→; -09/01; ☺ D2876LF02; 90A	8EL 737 985-001 Alternator	296
33.463 DFAK, DFA-KI	338 kW		01/94→			
33.463 DFAS	338 kW		01/94→			
33.463 DFC	338 kW		01/94→	01/94→; -09/01; ☺ D2876LF02; 55A	8EL 738 055-001 Alternator	297
33.463 DFK, DF-KI	338 kW		01/94→			
33.463 DFS, DFRS	338 kW		01/94→			
32.293 VFC	213 kW		08/95→	08/95→; -09/01; ☺ D2865LF24; 55A	8EL 725 736-001 Alternator	294
				08/95→; -09/01; ☺ D2865LF24; 35A	8EL 731 715-001 Alternator	295
				08/95→; -09/01; ☺ D2865LF24; 80A	8EL 732 707-001 Alternator	295
32.343 VFC	250 kW		08/95→	08/95→; -09/01; ☺ D2865LF21; 55A	8EL 725 736-001 Alternator	294
32.343 VFK	250 kW		08/95→			
35.343 VFC	250 kW		08/95→	08/95→; -09/01; ☺ D2865LF21; 35A	8EL 731 715-001 Alternator	295
35.343 VFK	250 kW		08/95→			
41.343 VFC	250 kW		08/95→			
41.343 VFK	250 kW		08/95→	08/95→; -09/01; ☺ D2865LF21; 80A	8EL 732 707-001 Alternator	295

Manufacturer - Model	Power	Displ.	Year of Constr.	Remark	Part Number	Page
MAN - F 2000						01/94→
32.403 VFC	294 kW		08/95→	08/95→; -09/01; ☺ D2866LF20; 55A	8EL 725 736-001 Alternator	294
32.403 VFK	294 kW		08/95→			
35.403 VF, VFC, VFRC	294 kW		08/95→	08/95→; -09/01; ☺ D2866LF20; 35A	8EL 731 715-001 Alternator	295
41.403 VF, VFC, VFRC	294 kW		08/95→			
41.403 VFK, VF-HK, VF-KI	294 kW		08/95→	08/95→; -09/01; ☺ D2866LF20; 80A	8EL 732 707-001 Alternator	295
				08/95→; -09/01; ☺ D2866LF20; 90A	8EL 737 985-001 Alternator	296
				08/95→; -09/01; ☺ D2866LF20; 55A	8EL 738 055-001 Alternator	297
32.463 VFC	338 kW		08/95→	08/95→; -09/01; ☺ D2876LF02; 55A	8EL 725 736-001 Alternator	294
35.463 VF, VFC, VFRC	338 kW		08/95→			
35.463 VFK, VF-HK, VF-KI	338 kW		08/95→	08/95→; -09/01; ☺ D2876LF02; 35A	8EL 731 715-001 Alternator	295
41.463 VF, VFC, VFRC	338 kW		08/95→			
41.463 VFK, VF-HK, VF-KI	338 kW		08/95→	08/95→; -09/01; ☺ D2876LF02; 80A	8EL 732 707-001 Alternator	295
				08/95→; -09/01; ☺ D2876LF02; 90A	8EL 737 985-001 Alternator	296
				08/95→; -09/01; ☺ D2876LF02; 55A	8EL 738 055-001 Alternator	297
32.463 VFK	338 kW		08/95→	08/95→; -09/01; ☺ D2876LF02; 55A	8EL 725 736-001 Alternator	294
				☺ D2876LF02; 35A	8EL 731 715-001 Alternator	295
				08/95→; -09/01; ☺ D2876LF02; 80A	8EL 732 707-001 Alternator	295
				08/95→; -09/01; ☺ D2876LF02; 90A	8EL 737 985-001 Alternator	296
				08/95→; -09/01; ☺ D2876LF02; 55A	8EL 738 055-001 Alternator	297
33.423 DFK, DF-KI	309 kW		01/94→	01/94→; -12/95; ☺ D2866LF22; 90A	8EL 737 985-001 Alternator	296
				01/94→; -12/95; ☺ D2866LF22; 55A	8EL 738 055-001 Alternator	297
40.403 DFAK	294 kW		01/94→	☺ D2866LF20; 55A	8EL 725 736-001 Alternator	294
40.403 DFAS	294 kW		01/94→			
40.403 DFK	294 kW		01/94→			
40.403 DFS	294 kW		01/94→			
40.463 DFAK	338 kW		01/94→	☺ D2876LF02; 55A	8EL 725 736-001 Alternator	294
40.463 DFAS	338 kW		01/94→			
40.463 DFK	338 kW		01/94→			
40.463 DFS	338 kW		01/94→			
MAN - G 90						09/87→05/95
10.150 F, 10.150 FL	92 kW		05/90→10/93	04/92→; -10/93; ☺ D0226MF/SILENT; 35A	8EL 725 644-001 Alternator	292
9.150 F, 9.150 FL	92 kW		05/90→10/93			
				☺ D0226MF/SILENT; 27A	8EL 725 729-001 Alternator	293
				05/90→; -03/92; ☺ D0226MF/SILENT; 35A	8EL 730 008-001 Alternator	294
10.150 F, 10.150 FL	110 - 114 kW		09/87→10/93	04/92→; -10/93; ☺ D0826GF01; 35A	8EL 725 644-001 Alternator	292
				☺ D0826GF01; 27A	8EL 725 729-001 Alternator	293
				☺ D0826GF03; 27A	8EL 725 729-001 Alternator	293
				10/92→; -10/93; ☺ D0826GF03; 55A	8EL 725 736-001 Alternator	294
				☺ D0826GF03; 35A	8EL 730 008-001 Alternator	294
				09/87→; -03/92; ☺ D0826GF01; 35A	8EL 730 008-001 Alternator	294
10.150 FK	110 - 114 kW		09/87→10/93	04/93→; -10/93; ☺ D0826GF01; 35A	8EL 725 644-001 Alternator	292
				☺ D0826GF01; 27A	8EL 725 729-001 Alternator	293
				☺ D0826GF03; 27A	8EL 725 729-001 Alternator	293
				10/92→; -10/93; ☺ D0826GF03; 55A	8EL 725 736-001 Alternator	294
				☺ D0826GF03; 35A	8EL 730 008-001 Alternator	294
				09/87→; -03/92; ☺ D0826GF01; 35A	8EL 730 008-001 Alternator	294

Manufacturer - Model	Power	Displ.	Year of Constr.	Remark	Part Number	Page
MAN - G 90				09/87→05/95		
6.100 F	75 kW		09/87→10/93	04/92→; →10/93; ☺ D0824GF02; 35A	8EL 725 644-001 Alternator	292
6.100 FK	75 kW		09/87→10/93	04/92→; →10/93; ☺ D0824GF; 35A	8EL 725 644-001 Alternator	292
8.100 F	75 kW		09/87→10/93	04/92→; →10/93; ☺ D0824GF01; 35A	8EL 725 644-001 Alternator	292
				☺ D0824GF02; 27A	8EL 725 729-001 Alternator	293
				☺ D0824GF; 27A	8EL 725 729-001 Alternator	293
				☺ D0824GF01; 27A	8EL 725 729-001 Alternator	293
				09/87→; →03/92; ☺ D0824GF02; 35A	8EL 730 008-001 Alternator	294
				09/87→; →03/92; ☺ D0824GF01; 35A	8EL 730 008-001 Alternator	294
				09/87→; →03/92; ☺ D0824GF; 35A	8EL 730 008-001 Alternator	294
8.100 FK	75 kW		09/87→10/93	04/93→; →10/93; ☺ D0824GF02; 35A	8EL 725 644-001 Alternator	292
				04/92→; →10/93; ☺ D0824GF; 35A	8EL 725 644-001 Alternator	292
				04/92→; →10/93; ☺ D0824GF01; 35A	8EL 725 644-001 Alternator	292
				☺ D0824GF02; 27A	8EL 725 729-001 Alternator	293
				☺ D0824GF; 27A	8EL 725 729-001 Alternator	293
				☺ D0824GF01; 27A	8EL 725 729-001 Alternator	293
				09/87→; →03/92; ☺ D0824GF02; 35A	8EL 730 008-001 Alternator	294
				09/87→; →03/92; ☺ D0824GF01; 35A	8EL 730 008-001 Alternator	294
				09/87→; →03/92; ☺ D0824GF; 35A	8EL 730 008-001 Alternator	294
8.150 F,8.150 FL	92 kW		05/90→10/93	04/92→; →10/93; ☺ D0226MF; 35A	8EL 725 644-001 Alternator	292
				☺ D0226MF; 27A	8EL 725 729-001 Alternator	293
				05/90→; →03/92; ☺ D0226MF; 35A	8EL 730 008-001 Alternator	294
8.150 F,8.150 FL	110 - 114 kW		09/87→10/93	04/92→; →10/93; ☺ D0826GF; 35A	8EL 725 644-001 Alternator	292
8.150 FK	110 - 114 kW		09/87→10/93			
8.150 FS,8.150 FLS	110 - 114 kW		09/87→10/93	☺ D0826GF; 27A	8EL 725 729-001 Alternator	293
9.150 F,9.150 FL	110 - 114 kW		09/87→10/93			
9.150 FK	110 - 114 kW		09/87→10/93	☺ D0826GF03; 27A	8EL 725 729-001 Alternator	293
9.150 FS,9.150 FLS	110 - 114 kW		09/87→10/93			
				10/92→; →10/93; ☺ D0826GF03; 55A	8EL 725 736-001 Alternator	294
				☺ D0826GF03; 35A	8EL 730 008-001 Alternator	294
				09/87→; →03/92; ☺ D0826GF; 35A	8EL 730 008-001 Alternator	294
8.150 FAE	110 - 114 kW		05/88→05/95	04/92→; →12/92; ☺ D0826GF; 35A	8EL 725 644-001 Alternator	292
				05/88→; →12/92; ☺ D0826GF; 27A	8EL 725 729-001 Alternator	293
				☺ D0826GF03; 27A	8EL 725 729-001 Alternator	293
				☺ D0826GF03; 55A	8EL 725 736-001 Alternator	294
				☺ D0826GF03; 35A	8EL 730 008-001 Alternator	294
				05/88→; →03/92; ☺ D0826GF; 35A	8EL 730 008-001 Alternator	294
8.150 FAKO	110 kW		10/92→05/95	☺ D0826GF03; 27A	8EL 725 729-001 Alternator	293
9.150 FAKO	110 kW		10/92→05/95			
				☺ D0826GF03; 55A	8EL 725 736-001 Alternator	294
				☺ D0826GF03; 35A	8EL 730 008-001 Alternator	294

Manufacturer - Model	Power	Displ.	Year of Constr.	Remark	Part Number	Page
MAN - G 90					09/87→05/95	
8.150 FOC 9.150 FOC	110 - 114 kW 110 - 114 kW		07/88→10/93 07/88→10/93	04/92→; →10/93; ⚙️ D0826GF01; 35A ⚙️ D0826GF01; 27A ⚙️ D0826GF03; 27A 10/92→; →10/93; ⚙️ D0826GF03; 55A ⚙️ D0826GF03; 35A 07/88→; →03/92; ⚙️ D0826GF01; 35A	8EL 725 644-001 Alternator 8EL 725 729-001 Alternator 8EL 725 729-001 Alternator 8EL 725 736-001 Alternator 8EL 730 008-001 Alternator 8EL 730 008-001 Alternator	292 293 293 294 294 294
8.170 FOC 9.170 FOC	125 - 131 kW 125 - 131 kW		02/89→10/93 02/89→10/93	04/92→; →10/93; ⚙️ D0226MCFO/170; 35A ⚙️ D0226MCFO/170; 55A ⚙️ D0226MCFO/170; 27A ⚙️ D0226MCFO/170; 55A 02/89→; →03/92; ⚙️ D0226MCFO/170; 35A	8EL 725 644-001 Alternator 8EL 725 663-001 Alternator 8EL 725 729-001 Alternator 8EL 725 736-001 Alternator 8EL 730 008-001 Alternator	292 293 293 294 294
9.150 FAE	110 - 114 kW		05/88→05/92	04/92→; →10/92; ⚙️ D0826GF; 35A ⚙️ D0826GF; 27A ⚙️ D0826GF03; 27A ⚙️ D0826GF03; 55A ⚙️ D0826GF03; 35A ⚙️ D0826GF; 35A	8EL 725 644-001 Alternator 8EL 725 729-001 Alternator 8EL 725 729-001 Alternator 8EL 725 736-001 Alternator 8EL 730 008-001 Alternator 8EL 730 008-001 Alternator	292 293 293 294 294 294
MAN - G					10/79→08/88	
10.136 F, 10.136 FL 10.136 FK 9.136 F, 9.136 FL	100 kW 100 kW 100 kW		09/81→09/87 09/81→09/87 10/79→09/87	⚙️ D0226MF; 27A 02/83→; →09/87; ⚙️ D0226MF; 35A	8EL 725 729-001 Alternator 8EL 730 008-001 Alternator	293 294
6.90 F 6.90 FK 8.90 F 8.90 FK	66 - 66 kW 66 kW 66 kW 66 kW		10/79→09/87 10/79→09/87 10/79→09/87 10/79→09/87	⚙️ D0224MF; 27A 02/83→; →09/87; ⚙️ D0224MF; 35A	8EL 725 729-001 Alternator 8EL 730 008-001 Alternator	293 294
8.136 F, 8.136 FL	100 kW		10/79→09/87	⚙️ D0226MF; 27A 02/83→; →09/87; ⚙️ D0226MF; 35A ⚙️ D0226MF; 35A	8EL 725 729-001 Alternator 8EL 730 008-001 Alternator 8EL 730 008-001 Alternator	293 294 294
8.136 FAE 9.136 FAE	100 kW 100 kW		12/83→08/88 12/83→08/88	⚙️ D0226MF; 27A ⚙️ D0226MF; 35A	8EL 725 729-001 Alternator 8EL 730 008-001 Alternator	293 294
8.136 FK 9.136 FK	100 kW 100 kW		10/79→08/88 10/79→08/88	⚙️ D0226MF; 27A 02/83→; →08/88; ⚙️ D0226MF; 35A	8EL 725 729-001 Alternator 8EL 730 008-001 Alternator	293 294
8.136 FOC 9.136 FOC	100 kW 100 kW		03/82→07/88 03/82→07/88	⚙️ D0226MF; 27A 02/83→; →07/88; ⚙️ D0226MF; 35A	8EL 725 729-001 Alternator 8EL 730 008-001 Alternator	293 294
MAN - HOCL						
24.440 HOCLN	316 kW			⚙️ D2066LOH10; 140A ⚙️ D2066LOH10; 120A	8EL 737 365-001 Alternator 8EL 738 212-291 Alternator	296 298
MAN - L 2000					10/93→	
10.145 LC, 10.145 LLC, LRC, LLRC (LE140C)	103 kW		09/00→	⚙️ D0834FL02; 90A ⚙️ D0834FL02; 55A	8EL 737 985-001 Alternator 8EL 738 055-001 Alternator	296 297

Manufacturer - Model	Power	Displ.	Year of Constr.	Remark	Part Number	Page
MAN - L 2000						10/93→
10.145 LK, LRK, L-KI, LR-KI (LE140C)	103 kW		09/00→	07/01→; ☺ D0834LFL02; 90A	8EL 737 985-001 Alternator	296
10.145 LLS, LLRS (LE140C)	103 kW		09/00→	07/01→; ☺ D0834LFL02; 55A	8EL 738 055-001 Alternator	297
8.145 LLS, LLRS (LE140C)	103 kW		09/00→			
8.145 LRK, L-KI, LR-KILK (LE140C)	103 kW		09/00→			
9.145 LC,9.145 LLC, LRC, LLRC (LE140C)	103 kW		09/00→			
9.145 LK, LRK, L-KI, LR-KI (LE140C)	103 kW		09/00→			
9.145 LLS, LLRS (LE140C)	103 kW		09/00→			
10.150 FOC	114 - 118 kW		02/95→01/96	☺ D0824LFO; 55A	8EL 725 736-001 Alternator	294
				☺ D0824LFO; 35A	8EL 731 715-001 Alternator	295
				☺ D0824LFO; 80A	8EL 732 707-001 Alternator	295
10.153 F	114 kW		10/93→	☺ D0824LFL01; 55A	8EL 725 736-001 Alternator	294
10.153 FA	114 kW		10/93→	☺ D0824LFL05; 55A	8EL 725 736-001 Alternator	294
				☺ D0824LFL01; 35A	8EL 730 008-001 Alternator	294
				☺ D0824LFL05; 35A	8EL 730 008-001 Alternator	294
				☺ D0824LFL05; 35A	8EL 731 715-001 Alternator	295
				☺ D0824LFL01; 35A	8EL 731 715-001 Alternator	295
				☺ D0824LFL01; 80A	8EL 732 707-001 Alternator	295
				☺ D0824LFL05; 80A	8EL 732 707-001 Alternator	295
10.153 LAEK	114 kW		10/93→06/96	01/95→; →06/96; ☺ D0824LFL01; 55A	8EL 725 736-001 Alternator	294
8.153 LAEK	114 kW		01/95→09/96	01/95→; →06/96; ☺ D0824LFL05; 55A	8EL 725 736-001 Alternator	294
8.153 LLS	114 kW		10/93→06/96			
				01/95→; →06/96; ☺ D0824LFL01; 35A	8EL 731 715-001 Alternator	295
				01/95→; →06/96; ☺ D0824LFL05; 35A	8EL 731 715-001 Alternator	295
				01/95→; →06/96; ☺ D0824LFL05; 80A	8EL 732 707-001 Alternator	295
				01/95→; →06/96; ☺ D0824LFL01; 80A	8EL 732 707-001 Alternator	295
10.153 LC,10.153 LLC	114 kW		10/93→06/96	☺ D0824LFL01; 55A	8EL 725 736-001 Alternator	294
10.153 LK	114 kW		10/93→06/96	☺ D0824LFL05; 55A	8EL 725 736-001 Alternator	294
10.153 LLS	114 kW		10/93→06/96			
				10/93→; →07/94; ☺ D0824LFL01; 35A	8EL 730 008-001 Alternator	294
				08/94→; →06/96; ☺ D0824LFL01; 35A	8EL 731 715-001 Alternator	295
				08/94→; →06/96; ☺ D0824LFL05; 35A	8EL 731 715-001 Alternator	295
				☺ D0824LFL05; 80A	8EL 732 707-001 Alternator	295
				☺ D0824LFL01; 80A	8EL 732 707-001 Alternator	295
10.163 LAC, LAEC, LARC, LAERC	114 - 118 kW		05/94→	05/94→; →12/95; ☺ D0824LFL02; 55A	8EL 725 736-001 Alternator	294
				08/95→; →03/97; ☺ D0824LFL06; 55A	8EL 725 736-001 Alternator	294
				03/00→; ☺ D0824LFL09; 55A	8EL 725 736-001 Alternator	294
				05/94→; →12/95; ☺ D0824LFL02; 35A	8EL 730 008-001 Alternator	294
				03/00→; ☺ D0824LFL09; 35A	8EL 731 715-001 Alternator	295
				08/95→; →03/97; ☺ D0824LFL06; 35A	8EL 731 715-001 Alternator	295
				05/94→; →12/95; ☺ D0824LFL02; 35A	8EL 731 715-001 Alternator	295

Manufacturer - Model	Power	Displ.	Year of Constr.	Remark	Part Number	Page
MAN - L 2000						10/93→
10.163 LAC, LAEC, LARC, LAERC	114 - 118 kW		05/94→	05/94→; →12/95; ⚙️ D0824LFL02; 80A	8EL 732 707-001 Alternator	295
				08/95→; →03/97; ⚙️ D0824LFL06; 80A	8EL 732 707-001 Alternator	295
				03/00→; ⚙️ D0824LFL09; 80A	8EL 732 707-001 Alternator	295
10.163 LAK, LAEK, LARK, LAERK	114 - 118 kW		01/95→	08/95→; →03/97; ⚙️ D0824LFL06; 55A	8EL 725 736-001 Alternator	294
				01/95→; →12/95; ⚙️ D0824LFL02; 55A	8EL 725 736-001 Alternator	294
				03/00→; ⚙️ D0824LFL09; 55A	8EL 725 736-001 Alternator	294
				08/95→; →03/97; ⚙️ D0824LFL06; 35A	8EL 731 715-001 Alternator	295
				03/00→; ⚙️ D0824LFL09; 35A	8EL 731 715-001 Alternator	295
				01/95→; →12/95; ⚙️ D0824LFL02; 35A	8EL 731 715-001 Alternator	295
				01/95→; →12/95; ⚙️ D0824LFL02; 80A	8EL 732 707-001 Alternator	295
				08/95→; →03/97; ⚙️ D0824LFL06; 80A	8EL 732 707-001 Alternator	295
				03/00→; ⚙️ D0824LFL09; 80A	8EL 732 707-001 Alternator	295
10.163 LC,10.163 LLC	114 - 118 kW		05/94→	08/95→; →03/97; ⚙️ D0824LFL06; 55A	8EL 725 736-001 Alternator	294
				05/94→; →12/95; ⚙️ D0824LFL02; 55A	8EL 725 736-001 Alternator	294
				03/00→; ⚙️ D0824LFL09; 55A	8EL 725 736-001 Alternator	294
				03/00→; ⚙️ D0824LFL09; 35A	8EL 731 715-001 Alternator	295
				08/95→; →03/97; ⚙️ D0824LFL06; 35A	8EL 731 715-001 Alternator	295
				05/94→; →12/95; ⚙️ D0824LFL02; 35A	8EL 731 715-001 Alternator	295
				08/95→; →03/97; ⚙️ D0824LFL06; 80A	8EL 732 707-001 Alternator	295
				03/00→; ⚙️ D0824LFL09; 80A	8EL 732 707-001 Alternator	295
				05/94→; →12/95; ⚙️ D0824LFL02; 80A	8EL 732 707-001 Alternator	295
10.163 LC,10.163 LLC, LRC, LLRC (LE160C)	114 kW		09/00→	09/00→; →09/01; ⚙️ D0824LFL09; 55A	8EL 725 736-001 Alternator	294
				09/00→; →09/01; ⚙️ D0824LFL09; 35A	8EL 731 715-001 Alternator	295
				09/00→; →09/01; ⚙️ D0824LFL09; 80A	8EL 732 707-001 Alternator	295
10.163 LK, LRK, L-KI, LR-KI	114 - 118 kW		05/94→	05/94→; →12/95; ⚙️ D0824LFL02; 55A	8EL 725 736-001 Alternator	294
				08/95→; →03/97; ⚙️ D0824LFL06; 55A	8EL 725 736-001 Alternator	294
				03/00→; ⚙️ D0824LFL09; 55A	8EL 725 736-001 Alternator	294
				05/94→; →12/95; ⚙️ D0824LFL02; 35A	8EL 730 008-001 Alternator	294
				03/00→; ⚙️ D0824LFL09; 35A	8EL 731 715-001 Alternator	295
				08/95→; →03/97; ⚙️ D0824LFL06; 35A	8EL 731 715-001 Alternator	295
				08/94→; →12/95; ⚙️ D0824LFL02; 35A	8EL 731 715-001 Alternator	295
				05/94→; →12/95; ⚙️ D0824LFL02; 80A	8EL 732 707-001 Alternator	295
				08/95→; →03/97; ⚙️ D0824LFL06; 80A	8EL 732 707-001 Alternator	295
03/00→; ⚙️ D0824LFL09; 80A	8EL 732 707-001 Alternator	295				
10.163 LLS, LLRS	114 - 118 kW		05/94→	03/02→; ⚙️ D0824LFL09; 55A	8EL 725 736-001 Alternator	294
				05/94→; →12/95; ⚙️ D0824LFL02; 55A	8EL 725 736-001 Alternator	294
				05/94→; →03/97; ⚙️ D0824LFL06; 55A	8EL 725 736-001 Alternator	294

Manufacturer - Model	Power	Displ.	Year of Constr.	Remark	Part Number	Page
MAN - L 2000						10/93→
10.163 LLS, LLRS	114 - 118 kW		05/94→	05/94→; -07/94; ☉ D0824LFL02; 35A	8EL 730 008-001 Alternator	294
				05/94→; -03/97; ☉ D0824LFL06; 35A	8EL 731 715-001 Alternator	295
				03/02→; ☉ D0824LFL09; 35A	8EL 731 715-001 Alternator	295
				08/94→; -12/95; ☉ D0824LFL02; 35A	8EL 731 715-001 Alternator	295
				03/02→; ☉ D0824LFL09; 80A	8EL 732 707-001 Alternator	295
				05/94→; -12/95; ☉ D0824LFL02; 80A	8EL 732 707-001 Alternator	295
				05/94→; -03/97; ☉ D0824LFL06; 80A	8EL 732 707-001 Alternator	295
10.185 LAC, LAEC, LARC, LAERC, LA-LA, LAE-LF (LE180C) 10.185 LAK, LAEK, LARK, LAERK (LE180C) 10.185 LK, LRK, L-KI, LR-KI (LE180C) 10.185 LLS, LLRS (LE180C) 8.185 LAC, LAEC, LARC, LAERC, LA-LF, LAE-LF (LE180C) 8.185 LAK, LAEK, LARK, LAERK (LE180C) 8.185 LK, LRK, L-KI, LR-KI (LE180C) 8.185 LLS, LLRS (LE180C)	132 kW		09/00→	☉ D0834LFL03; 90A	8EL 737 985-001 Alternator	296
				☉ D0834LFL03; 55A	8EL 738 055-001 Alternator	297
				09/00→; -08/02; ☉ D0834LFL03; 90A	8EL 737 985-001 Alternator	296
				09/00→; -08/02; ☉ D0834LFL03; 55A	8EL 738 055-001 Alternator	297
				09/00→		
				09/00→		
				09/00→		
				09/00→		
				09/00→		
				09/00→		
10.220 FOC,10.220 FOCL	162 kW		02/95→	02/95→; -02/01; ☉ D0826LFL03; 55A	8EL 725 736-001 Alternator	294
				02/95→; -02/01; ☉ D0826LFL03; 35A	8EL 731 715-001 Alternator	295
				02/95→; -02/01; ☉ D0826LFL03; 80A	8EL 732 707-001 Alternator	295
10.223 F, 10.223 FL 10.223 FA 10.223 LAEC 8.223 LAEC	162 kW		10/93→06/96 10/93→06/96 01/95→06/96 01/95→06/96	☉ D0826LFL06; 55A	8EL 725 736-001 Alternator	294
				☉ D0826LFL06; 35A	8EL 731 715-001 Alternator	295
				☉ D0826LFL06; 80A	8EL 732 707-001 Alternator	295
10.223 LC,10.223 LLC 10.223 LK 10.223 LLS 9.223 LK	162 - 169 kW		10/93→06/96 10/93→06/96 10/93→06/96 10/93→06/96	05/94→; -06/96; ☉ D0826LFL02; 55A	8EL 725 736-001 Alternator	294
				05/94→; -06/96; ☉ D0826LFL06; 55A	8EL 725 736-001 Alternator	294
				05/94→; -07/94; ☉ D0826LFL02; 35A	8EL 730 008-001 Alternator	294
				05/94→; -07/94; ☉ D0826LFL06; 35A	8EL 730 008-001 Alternator	294
				08/94→; -06/96; ☉ D0826LFL02; 35A	8EL 731 715-001 Alternator	295
				08/94→; -06/96; ☉ D0826LFL06; 35A	8EL 731 715-001 Alternator	295
				05/94→; -06/96; ☉ D0826LFL02; 80A	8EL 732 707-001 Alternator	295
				05/94→; -06/96; ☉ D0826LFL06; 80A	8EL 732 707-001 Alternator	295
10.224 F, 10.224 FL 10.224 FA	162 kW		05/94→ 05/94→	☉ D0826LFL03; 55A	8EL 725 736-001 Alternator	294
				☉ D0826LFL03; 35A	8EL 730 008-001 Alternator	294
				☉ D0826LFL03; 35A	8EL 731 715-001 Alternator	295
				☉ D0826LFL03; 80A	8EL 732 707-001 Alternator	295

Manufacturer - Model	Power	Displ.	Year of Constr.	Remark	Part Number	Page
MAN - L 2000						10/93→
10.224 LAC, LAEC, LARC, LAERC	162 kW		01/95→	01/95→; -02/01; ☼ D0826LFL03; 55A	8EL 725 736-001 Alternator	294
10.224 LAK, LAEK, LARK, LAERK	162 kW		01/95→	01/95→; -02/01; ☼ D0826LFL03; 35A	8EL 731 715-001 Alternator	295
				01/95→; -02/01; ☼ D0826LFL03; 80A	8EL 732 707-001 Alternator	295
10.224 LC, 10.224 LLC, LRC, LLRC	162 kW		05/94→	05/94→; -02/01; ☼ D0826LFL03; 55A	8EL 725 736-001 Alternator	294
10.224 LK, LRK, L-KI, LR-KI	162 kW		05/94→	05/94→; -07/94; ☼ D0826LFL03; 35A	8EL 730 008-001 Alternator	294
10.224 LLS, LLRS	162 kW		05/94→	08/94→; -02/01; ☼ D0826LFL03; 35A	8EL 731 715-001 Alternator	295
				05/94→; -02/01; ☼ D0826LFL03; 80A	8EL 732 707-001 Alternator	295
10.225 LAC, LAEC, LARC, LAERC, LA-LF, LAE-LF (LE220C)	162 kW		09/00→	07/01→; ☼ D0836LFL02; 90A	8EL 737 985-001 Alternator	296
10.225 LAK, LAEK, LARK, LAERK (LE220C)	162 kW		09/00→	07/01→; ☼ D0836LFL02; 55A	8EL 738 055-001 Alternator	297
10.225 LK, LRK, L-KI, LR-KI (LE220C)	162 kW		09/00→			
10.225 LLS, LLRS (LE220C)	162 kW		09/00→			
12.225 LC, LLC (LE220C)	162 kW		09/99→			
8.225 LAC, LAEC, LARC, LAERC (LE220C)	162 kW		09/00→			
8.225 LAK, LAEK, LARK, LAERK (LE220C)	162 kW		09/00→			
8.225 LK, LRK, L-KI, LR-KI (LE220C)	162 kW		09/00→			
8.225 LLS, LLRS (LE220C)	162 kW		09/00→			
10.225 LC, 10.225 LLC, LRC, LLRC	162 kW		09/00→	☼ D0836LFL02; 90A	8EL 737 985-001 Alternator	296
				☼ D0836LFL02; 55A	8EL 738 055-001 Alternator	297
10.225 LC, 10.225 LLC, LRC, LLRC (LE220C)	162 kW		09/00→	07/01→; -08/02; ☼ D0836LFL02; 90A	8EL 737 985-001 Alternator	296
				07/01→; -08/02; ☼ D0836LFL02; 55A	8EL 738 055-001 Alternator	297
12.185 LC, LLC (LE180C)	132 kW		09/99→	07/01→; ☼ D0834LFL03; 90A	8EL 737 985-001 Alternator	296
				07/01→; ☼ D0834LFL03; 55A	8EL 738 055-001 Alternator	297
8.103 LC, 8.103 LLC	75 kW		10/93→06/96	☼ D0824FL01; 55A	8EL 725 736-001 Alternator	294
				☼ D0824FL01; 35A	8EL 730 008-001 Alternator	294
				08/94→; -06/96; ☼ D0824FL01; 35A	8EL 731 715-001 Alternator	295
				☼ D0824FL01; 80A	8EL 732 707-001 Alternator	295
8.103 LK	75 kW		10/93→06/96	☼ D0824FL01; 55A	8EL 725 736-001 Alternator	294
				☼ D0824FL01; 35A	8EL 730 008-001 Alternator	294
				☼ D0824FL01; 35A	8EL 731 715-001 Alternator	295
				☼ D0824FL01; 80A	8EL 732 707-001 Alternator	295
8.113 LC, 8.113 LLC	81 kW		08/95→	08/95→; -03/97; ☼ D0824LFL04; 55A	8EL 725 736-001 Alternator	294
8.113 LK, LRK, L-KI, LR-KI	81 kW		08/95→	08/95→; -03/97; ☼ D0824LFL04; 35A	8EL 731 715-001 Alternator	295
				08/95→; -03/97; ☼ D0824LFL04; 80A	8EL 732 707-001 Alternator	295
8.113 LC, 8.113 LLC, LRC, LLRC, (LE110C)	83 kW		09/00→	09/00→; -09/01; ☼ D0824LFL08; 55A	8EL 725 736-001 Alternator	294
				09/00→; -09/01; ☼ D0824LFL08; 35A	8EL 731 715-001 Alternator	295
				09/00→; -09/01; ☼ D0824LFL08; 80A	8EL 732 707-001 Alternator	295
8.145 LC, 8.145 LLC, L-LF (LE140C)	103 kW		09/00→	07/01→; -08/02; ☼ D0834LFL02; 90A	8EL 737 985-001 Alternator	296
				07/01→; -08/02; ☼ D0834LFL02; 55A	8EL 738 055-001 Alternator	297

Manufacturer - Model	Power	Displ.	Year of Constr.	Remark	Part Number	Page
MAN - L 2000						10/93→
8.150 FOC,8.150 FOCL	114 - 118 kW		02/95→	02/95→; -07/98; ☺ D0824LFO; 55A	8EL 725 736-001 Alternator	294
				02/95→; -07/98; ☺ D0824LFO; 35A	8EL 731 715-001 Alternator	295
				02/95→; -07/98; ☺ D0824LFO; 80A	8EL 732 707-001 Alternator	295
8.153 LAEC	114 kW		01/95→06/96	☺ D0824LFL01; 55A	8EL 725 736-001 Alternator	294
				☺ D0824LFL05; 55A	8EL 725 736-001 Alternator	294
				☺ D0824LFL05; 35A	8EL 731 715-001 Alternator	295
				☺ D0824LFL01; 35A	8EL 731 715-001 Alternator	295
				☺ D0824LFL05; 80A	8EL 732 707-001 Alternator	295
				☺ D0824LFL01; 80A	8EL 732 707-001 Alternator	295
8.153 LC,8.153 LLC 8.153 LK	114 kW		10/93→07/97 10/93→07/97	10/93→; -01/95; ☺ D0824LFL01; 55A	8EL 725 736-001 Alternator	294
	114 kW			08/95→; -07/97; ☺ D0824LFL05; 55A	8EL 725 736-001 Alternator	294
				10/93→; -07/94; ☺ D0824LFL01; 35A	8EL 730 008-001 Alternator	294
				08/95→; -07/97; ☺ D0824LFL05; 35A	8EL 731 715-001 Alternator	295
				08/94→; -01/95; ☺ D0824LFL01; 35A	8EL 731 715-001 Alternator	295
				10/93→; -01/95; ☺ D0824LFL01; 80A	8EL 732 707-001 Alternator	295
				08/95→; -07/97; ☺ D0824LFL05; 80A	8EL 732 707-001 Alternator	295
8.163 LAC, LAEC, LARC, LAERC, LA-LF, LAE-LF	114 - 118 kW		01/95→	03/97→; -09/02; ☺ D0824LFL09; 55A	8EL 725 736-001 Alternator	294
				01/95→; -03/97; ☺ D0824LFL06; 55A	8EL 725 736-001 Alternator	294
				01/95→; -09/01; ☺ D0824LFL02; 55A	8EL 725 736-001 Alternator	294
				03/97→; -09/02; ☺ D0824LFL09; 35A	8EL 731 715-001 Alternator	295
				01/95→; -03/97; ☺ D0824LFL06; 35A	8EL 731 715-001 Alternator	295
				01/95→; -09/01; ☺ D0824LFL02; 35A	8EL 731 715-001 Alternator	295
				03/97→; -09/02; ☺ D0824LFL09; 80A	8EL 732 707-001 Alternator	295
				01/95→; -03/97; ☺ D0824LFL06; 80A	8EL 732 707-001 Alternator	295
				01/95→; -09/01; ☺ D0824LFL02; 80A	8EL 732 707-001 Alternator	295
8.163 LAEC 9.163 LC 9.163 LK	104 kW		08/95→03/97 08/95→03/97 08/95→03/97	☺ D0824LFL07; 55A	8EL 725 736-001 Alternator	294
	104 kW			☺ D0824LFL07; 35A	8EL 731 715-001 Alternator	295
	104 kW			☺ D0824LFL07; 80A	8EL 732 707-001 Alternator	295
8.163 LC,8.163 LLC	114 - 118 kW		05/94→	03/97→; -09/02; ☺ D0824LFL09; 55A	8EL 725 736-001 Alternator	294
				05/94→; -12/95; ☺ D0824LFL02; 55A	8EL 725 736-001 Alternator	294
				05/94→; -03/97; ☺ D0824LFL06; 55A	8EL 725 736-001 Alternator	294
				05/94→; -07/94; ☺ D0824LFL02; 35A	8EL 730 008-001 Alternator	294
				05/94→; -03/97; ☺ D0824LFL06; 35A	8EL 731 715-001 Alternator	295
				03/97→; -09/02; ☺ D0824LFL09; 35A	8EL 731 715-001 Alternator	295
				08/94→; -12/95; ☺ D0824LFL02; 35A	8EL 731 715-001 Alternator	295
				03/97→; -09/02; ☺ D0824LFL09; 80A	8EL 732 707-001 Alternator	295
				05/94→; -12/95; ☺ D0824LFL02; 80A	8EL 732 707-001 Alternator	295

Manufacturer - Model	Power	Displ.	Year of Constr.	Remark	Part Number	Page				
MAN - L 2000						10/93→				
8.163 LC,8.163 LLC	114 - 118 kW		05/94→	05/94→; -03/97; ⚡ D0824LFL06; 80A	8EL 732 707-001 Alternator	295				
8.163 LC,8.163 LLC, LRC, LLRC, L-LF	104 kW		08/95→	08/95→; -03/01; ⚡ D0824LFL07; 55A	8EL 725 736-001 Alternator	294				
				08/95→; -03/01; ⚡ D0824LFL07; 35A	8EL 731 715-001 Alternator	295				
				08/95→; -03/01; ⚡ D0824LFL07; 80A	8EL 732 707-001 Alternator	295				
8.163 LC, 8.163 LLC (LE160C)	114 kW		09/00→	09/00→; -02/02; ⚡ D0824LFL09; 55A	8EL 725 736-001 Alternator	294				
				09/00→; -02/02; ⚡ D0824LFL09; 35A	8EL 731 715-001 Alternator	295				
				09/00→; -02/02; ⚡ D0824LFL09; 80A	8EL 732 707-001 Alternator	295				
8.163 LK, LRK, L-KI, LR-KI	114 - 118 kW		05/94→	05/94→; -03/97; ⚡ D0824LFL06; 55A	8EL 725 736-001 Alternator	294				
				03/97→; -02/02; ⚡ D0824LFL09; 55A	8EL 725 736-001 Alternator	294				
				05/94→; -09/01; ⚡ D0824LFL02; 55A	8EL 725 736-001 Alternator	294				
				05/94→; -07/94; ⚡ D0824LFL02; 35A	8EL 730 008-001 Alternator	294				
				03/97→; -02/02; ⚡ D0824LFL09; 35A	8EL 731 715-001 Alternator	295				
				08/94→; -09/01; ⚡ D0824LFL02; 35A	8EL 731 715-001 Alternator	295				
				05/94→; -03/97; ⚡ D0824LFL06; 35A	8EL 731 715-001 Alternator	295				
				05/94→; -09/01; ⚡ D0824LFL02; 80A	8EL 732 707-001 Alternator	295				
				03/97→; -02/02; ⚡ D0824LFL09; 80A	8EL 732 707-001 Alternator	295				
				05/94→; -03/97; ⚡ D0824LFL06; 80A	8EL 732 707-001 Alternator	295				
				8.163 LLS, LLRS	114 - 118 kW		05/94→	05/94→; -03/97; ⚡ D0824LFL06; 55A	8EL 725 736-001 Alternator	294
								03/97→; -09/02; ⚡ D0824LFL09; 55A	8EL 725 736-001 Alternator	294
05/94→; -09/01; ⚡ D0824LFL02; 55A	8EL 725 736-001 Alternator	294								
05/94→; -07/94; ⚡ D0824LFL02; 35A	8EL 730 008-001 Alternator	294								
03/97→; -09/02; ⚡ D0824LFL09; 35A	8EL 731 715-001 Alternator	295								
08/94→; -09/01; ⚡ D0824LFL02; 35A	8EL 731 715-001 Alternator	295								
05/94→; -03/97; ⚡ D0824LFL06; 35A	8EL 731 715-001 Alternator	295								
05/94→; -09/01; ⚡ D0824LFL02; 80A	8EL 732 707-001 Alternator	295								
03/97→; -09/02; ⚡ D0824LFL09; 80A	8EL 732 707-001 Alternator	295								
05/94→; -03/97; ⚡ D0824LFL06; 80A	8EL 732 707-001 Alternator	295								
8.220 FOC,8.220 FOCL	162 kW		04/95→	04/95→; -09/01; ⚡ D0826LFL03; 55A	8EL 725 736-001 Alternator	294				
				04/95→; -09/01; ⚡ D0826LFL03; 35A	8EL 731 715-001 Alternator	295				
				04/95→; -09/01; ⚡ D0826LFL03; 80A	8EL 732 707-001 Alternator	295				
8.223 LC,8.223 LLC	162 - 169 kW		10/93→06/96	⚡ D0826LFL02; 35A	8EL 725 644-001 Alternator	292				
				05/94→; -06/96; ⚡ D0826LFL02; 55A	8EL 725 736-001 Alternator	294				
				05/94→; -06/96; ⚡ D0826LFL06; 55A	8EL 725 736-001 Alternator	294				
				05/94→; -07/94; ⚡ D0826LFL02; 35A	8EL 730 008-001 Alternator	294				
				05/94→; -07/94; ⚡ D0826LFL06; 35A	8EL 730 008-001 Alternator	294				
				08/94→; -06/96; ⚡ D0826LFL02; 35A	8EL 731 715-001 Alternator	295				
				08/94→; -06/96; ⚡ D0826LFL06; 35A	8EL 731 715-001 Alternator	295				

Manufacturer - Model	Power	Displ.	Year of Constr.	Remark	Part Number	Page
MAN - L 2000						10/93→
8.223 LC,8.223 LLC	162 - 169 kW		10/93→06/96	05/94→; →06/96; ⚙️ D0826LFL02; 80A	8EL 732 707-001 Alternator	295
				05/94→; →06/96; ⚙️ D0826LFL06; 80A	8EL 732 707-001 Alternator	295
8.223 LK	162 - 169 kW		10/93→06/96	05/94→; →01/95; ⚙️ D0826LFL06; 55A	8EL 725 736-001 Alternator	294
				05/94→; →01/95; ⚙️ D0826LFL02; 55A	8EL 725 736-001 Alternator	294
				05/94→; →07/94; ⚙️ D0826LFL06; 35A	8EL 730 008-001 Alternator	294
				05/94→; →07/94; ⚙️ D0826LFL02; 35A	8EL 730 008-001 Alternator	294
				08/94→; →01/95; ⚙️ D0826LFL02; 35A	8EL 731 715-001 Alternator	295
				08/94→; →01/95; ⚙️ D0826LFL06; 35A	8EL 731 715-001 Alternator	295
				05/94→; →01/95; ⚙️ D0826LFL06; 80A	8EL 732 707-001 Alternator	295
				05/94→; →01/95; ⚙️ D0826LFL02; 80A	8EL 732 707-001 Alternator	295
8.223 LLS	162 - 169 kW		10/93→06/96	⚙️ D0826LFL02; 35A	8EL 725 644-001 Alternator	292
				⚙️ D0826LFL02; 55A	8EL 725 736-001 Alternator	294
				⚙️ D0826LFL06; 55A	8EL 725 736-001 Alternator	294
				⚙️ D0826LFL06; 35A	8EL 730 008-001 Alternator	294
				⚙️ D0826LFL02; 35A	8EL 731 715-001 Alternator	295
				⚙️ D0826LFL06; 35A	8EL 731 715-001 Alternator	295
				⚙️ D0826LFL06; 80A	8EL 732 707-001 Alternator	295
				⚙️ D0826LFL02; 80A	8EL 732 707-001 Alternator	295
8.224 LAC, LAEC, LARC, LAERC	162 kW		01/95→	⚙️ D0826LFL03; 80A	8EL 732 707-001 Alternator	295
8.224 LAK, LAEK, LARK, LAERK	162 kW		01/95→	01/95→; →08/01; ⚙️ D0826LFL03; 55A	8EL 725 736-001 Alternator	294
				01/95→; →08/01; ⚙️ D0826LFL03; 35A	8EL 731 715-001 Alternator	295
				01/95→; →08/01; ⚙️ D0826LFL03; 80A	8EL 732 707-001 Alternator	295
8.224 LC,8.224 LLC, LRC, LLRC	162 kW		05/94→	05/94→; →01/95; ⚙️ D0826LFL03; 55A	8EL 725 736-001 Alternator	294
				05/94→; →01/95; ⚙️ D0826LFL03; 35A	8EL 730 008-001 Alternator	294
				08/94→; →01/95; ⚙️ D0826LFL03; 35A	8EL 731 715-001 Alternator	295
				05/94→; →01/95; ⚙️ D0826LFL03; 80A	8EL 732 707-001 Alternator	295
8.224 LK, LRK, L-KI, LR-KI 9.224 LC,9.224 LLC, LRC, LLRC 9.224 LK, LRK, L-KI, LR-KI 9.224 LLS, LLRS	162 kW		05/94→	05/94→; →09/01; ⚙️ D0826LFL03; 55A	8EL 725 736-001 Alternator	294
	162 kW		05/94→			
	162 kW		05/94→	05/94→; →07/94; ⚙️ D0826LFL03; 35A	8EL 730 008-001 Alternator	294
	162 kW		05/94→	08/94→; →09/01; ⚙️ D0826LFL03; 35A	8EL 731 715-001 Alternator	295
				05/94→; →09/01; ⚙️ D0826LFL03; 80A	8EL 732 707-001 Alternator	295
8.224 LLS, LLRS	162 kW		05/94→	05/94→; →03/01; ⚙️ D0826LFL03; 55A	8EL 725 736-001 Alternator	294
				05/94→; →03/01; ⚙️ D0826LFL03; 35A	8EL 730 008-001 Alternator	294
				08/94→; →03/01; ⚙️ D0826LFL03; 35A	8EL 731 715-001 Alternator	295
				05/94→; →03/01; ⚙️ D0826LFL03; 80A	8EL 732 707-001 Alternator	295

Manufacturer - Model	Power	Displ.	Year of Constr.	Remark	Part Number	Page
MAN - L 2000						10/93→
8.225 LC,8.225 LLC, LRC, LLRC (LE220C)	162 kW		09/00→	07/01→; →08/02; ⚙️ D0836LFL02; 90A	8EL 737 985-001 Alternator	296
				07/01→; →08/02; ⚙️ D0826LFL10; 90A	8EL 737 985-001 Alternator	296
				07/01→; →08/02; ⚙️ D0826LFL10; 55A	8EL 738 055-001 Alternator	297
				07/01→; →08/02; ⚙️ D0836LFL02; 55A	8EL 738 055-001 Alternator	297
9.153 LC,9.153 LLC 9.153 LK	114 kW		10/93→06/96	10/93→; →01/95; ⚙️ D0824LFL01; 55A	8EL 725 736-001 Alternator	294
	114 kW		10/93→06/96	08/95→; →06/96; ⚙️ D0824LFL05; 55A	8EL 725 736-001 Alternator	294
				10/93→; →07/94; ⚙️ D0824LFL01; 35A	8EL 730 008-001 Alternator	294
				08/95→; →06/96; ⚙️ D0824LFL05; 35A	8EL 731 715-001 Alternator	295
				08/94→; →01/95; ⚙️ D0824LFL01; 35A	8EL 731 715-001 Alternator	295
				10/93→; →01/95; ⚙️ D0824LFL01; 80A	8EL 732 707-001 Alternator	295
				08/95→; →06/96; ⚙️ D0824LFL05; 80A	8EL 732 707-001 Alternator	295
9.153 LLS	114 kW		10/93→12/95	08/95→; →06/96; ⚙️ D0824LFL05; 55A	8EL 725 736-001 Alternator	294
				⚙️ D0824LFL01; 55A	8EL 725 736-001 Alternator	294
				10/93→; →07/94; ⚙️ D0824LFL01; 35A	8EL 730 008-001 Alternator	294
				08/95→; →06/96; ⚙️ D0824LFL05; 35A	8EL 731 715-001 Alternator	295
				08/94→; →12/95; ⚙️ D0824LFL01; 35A	8EL 731 715-001 Alternator	295
				⚙️ D0824LFL01; 80A	8EL 732 707-001 Alternator	295
				08/95→; →06/96; ⚙️ D0824LFL05; 80A	8EL 732 707-001 Alternator	295
9.163 LC,9.163 LLC, LRC, LLRC	114 - 118 kW		05/94→	05/94→; →12/95; ⚙️ D0824LFL02; 55A	8EL 725 736-001 Alternator	294
				05/94→; →03/97; ⚙️ D0824LFL06; 55A	8EL 725 736-001 Alternator	294
				03/97→; →09/01; ⚙️ D0824LFL09; 55A	8EL 725 736-001 Alternator	294
				05/94→; →07/94; ⚙️ D0824LFL02; 35A	8EL 730 008-001 Alternator	294
				08/95→; →12/95; ⚙️ D0824LFL02; 35A	8EL 731 715-001 Alternator	295
				05/94→; →03/97; ⚙️ D0824LFL06; 35A	8EL 731 715-001 Alternator	295
				03/97→; →09/01; ⚙️ D0824LFL09; 35A	8EL 731 715-001 Alternator	295
				05/94→; →03/97; ⚙️ D0824LFL06; 80A	8EL 732 707-001 Alternator	295
				05/94→; →12/95; ⚙️ D0824LFL02; 80A	8EL 732 707-001 Alternator	295
				03/97→; →09/01; ⚙️ D0824LFL09; 80A	8EL 732 707-001 Alternator	295
9.163 LK, LRK, L-KI, LR-KI 9.163 LLS, LLRS	114 - 118 kW		05/94→	05/94→; →12/95; ⚙️ D0824LFL02; 55A	8EL 725 736-001 Alternator	294
	114 - 118 kW		05/94→	05/94→; →03/97; ⚙️ D0824LFL06; 55A	8EL 725 736-001 Alternator	294
				03/97→; →09/01; ⚙️ D0824LFL09; 55A	8EL 725 736-001 Alternator	294
				05/94→; →07/94; ⚙️ D0824LFL02; 35A	8EL 730 008-001 Alternator	294
				08/94→; →12/95; ⚙️ D0824LFL02; 35A	8EL 731 715-001 Alternator	295
				05/94→; →03/97; ⚙️ D0824LFL06; 35A	8EL 731 715-001 Alternator	295
				03/97→; →09/01; ⚙️ D0824LFL09; 35A	8EL 731 715-001 Alternator	295
				05/94→; →03/97; ⚙️ D0824LFL06; 80A	8EL 732 707-001 Alternator	295
				03/97→; →09/01; ⚙️ D0824LFL09; 80A	8EL 732 707-001 Alternator	295

Manufacturer - Model	Power	Displ.	Year of Constr.	Remark	Part Number	Page
MAN - L 2000						10/93→
9.163 LK, LRK, L-KI, LR-KI	114 - 118 kW		05/94→	05/94→; -12/95; ⚡ D0824LFL02; 80A	8EL 732 707-001 Alternator	295
9.163 LLS, LLRS	114 - 118 kW		05/94→			
9.223 LC,9.223 LLC	162 - 169 kW		10/93→06/96	05/94→; -06/96; ⚡ D0826LFL02; 55A	8EL 725 736-001 Alternator	294
				05/94→; -06/96; ⚡ D0826LFL06; 55A	8EL 725 736-001 Alternator	294
				05/94→; -07/94; ⚡ D0826LFL06; 35A	8EL 730 008-001 Alternator	294
				05/84→; -07/94; ⚡ D0826LFL02; 35A	8EL 730 008-001 Alternator	294
				08/94→; -06/96; ⚡ D0826LFL02; 35A	8EL 731 715-001 Alternator	295
				08/94→; -06/96; ⚡ D0826LFL06; 35A	8EL 731 715-001 Alternator	295
				05/94→; -06/96; ⚡ D0826LFL02; 80A	8EL 732 707-001 Alternator	295
				05/94→; -06/96; ⚡ D0826LFL06; 80A	8EL 732 707-001 Alternator	295
9.223 LLS	162 - 169 kW		10/93→06/96	05/94→; -06/96; ⚡ D0826LFL02; 55A	8EL 725 736-001 Alternator	294
				05/94→; -06/96; ⚡ D0826LFL06; 55A	8EL 725 736-001 Alternator	294
				05/94→; -07/94; ⚡ D0826LFL02; 35A	8EL 730 008-001 Alternator	294
				05/94→; -07/94; ⚡ D0826LFL06; 35A	8EL 730 008-001 Alternator	294
				05/94→; -06/96; ⚡ D0826LFL02; 35A	8EL 731 715-001 Alternator	295
				05/94→; -06/96; ⚡ D0826LFL06; 35A	8EL 731 715-001 Alternator	295
				05/94→; -06/96; ⚡ D0826LFL02; 80A	8EL 732 707-001 Alternator	295
				05/94→; -06/96; ⚡ D0826LFL06; 80A	8EL 732 707-001 Alternator	295
9.225 LC,9.225 LLC, LRC, LLRC (LE220C)	162 kW		09/00→	07/01→; -06/05; ⚡ D0836LFL02; 90A	8EL 737 985-001 Alternator	296
9.225 LK, LRK, L-KI, LR-KI (LE220C)	162 kW		09/00→	07/01→; -06/05; ⚡ D0836LFL02; 55A	8EL 738 055-001 Alternator	297
9.225 LLS, LLRS (LE220C)	162 kW		09/00→			
MAN - LION S COACH						09/95→
FRH 352,RH 353	257 kW		09/95→	09/95→; -09/01; ⚡ D2866LOH26; 140A	8EL 737 365-001 Alternator	296
FRH 402,RH 403	294 kW		09/95→	09/95→; -09/01; ⚡ D2866LOH23; 140A	8EL 737 365-001 Alternator	296
RH 402	294 kW		09/98→	09/98→; -09/01; ⚡ D2866LOH23; 140A	8EL 737 365-001 Alternator	296
RH 463, RHC 464	338 kW		01/00→	01/00→; -09/01; ⚡ D2876LOH02; 140A	8EL 737 365-001 Alternator	296
				01/00→; -09/01; ⚡ D2876LOH01; 140A	8EL 737 365-001 Alternator	296
				01/00→; -09/01; ⚡ D2876LOH03; 140A	8EL 737 365-001 Alternator	296
RHC 414	301 kW		06/02→	09/02→; -09/06; ⚡ D2866LOH34; 140A	8EL 737 365-001 Alternator	296
				09/02→; -09/06; ⚡ D2866LOH34; 90A	8EL 737 985-001 Alternator	296
MAN - LION S COMFORT						09/96→
RN 313	228 kW		09/96→	09/96→; -03/98; ⚡ D2866LUH20; 140A	8EL 737 365-001 Alternator	296
				09/96→; -03/98; ⚡ D2866LUH26; 140A	8EL 737 365-001 Alternator	296
RN 353	257 kW		06/97→	06/97→; -03/98; ⚡ D2866LUH21; 140A	8EL 737 365-001 Alternator	296
MAN - LION S STAR						01/93→
FRH 352,RH 353	257 kW		09/95→	09/95→; -11/99; ⚡ D2866LOH26; 140A	8EL 737 365-001 Alternator	296
FRH 402,RH 403	294 kW		09/95→	09/95→; -09/01; ⚡ D2866LOH23; 140A	8EL 737 365-001 Alternator	296
FRH 422	309 kW		01/93→09/96	⚡ D2866LOH20; 140A	8EL 737 365-001 Alternator	296

Manufacturer - Model	Power	Displ.	Year of Constr.	Remark	Part Number	Page
MAN - LION S STAR						01/93→
RH 464, RHS 464	301 kW		03/00→	03/00→; -09/06; ☺ D2866LOH34; 140A	8EL 737 365-001 Alternator	296
				03/00→; -09/06; ☺ D2866LOH34; 90A	8EL 737 985-001 Alternator	296
RH 464, RHS 464	301 kW		01/02→	01/02→; -09/06; ☺ D2866LOH34; 140A	8EL 737 365-001 Alternator	296
				01/02→; -09/06; ☺ D2866LOH34; 90A	8EL 737 985-001 Alternator	296
RH 414	338 kW		03/00→	10/01→; -09/06; ☺ D2876LOH03; 140A	8EL 737 365-001 Alternator	296
				10/01→; -09/06; ☺ D2876LOH03; 90A	8EL 737 985-001 Alternator	296
RH 464, RHS 464	338 kW		01/02→	01/02→; -09/06; ☺ D2876LOH03; 140A	8EL 737 365-001 Alternator	296
				01/02→; -09/06; ☺ D2876LOH03; 90A	8EL 737 985-001 Alternator	296
				01/02→; -09/06; ☺ D2876LOH03; 110A	8EL 738 211-261 Alternator	298
MAN - M 90						08/88→06/96
12.152 F, 12.152 FL 12.152 FS, 12.152 FLS	110 - 114 kW 110 - 114 kW		12/88→05/94 12/88→05/94	☺ D0826F01; 55A	8EL 725 663-001 Alternator	293
				10/92→; -05/94; ☺ D0826F02; 55A	8EL 725 736-001 Alternator	294
				10/92→; -05/94; ☺ D0826F02; 35A	8EL 730 008-001 Alternator	294
				☺ D0826F01; 35A	8EL 730 008-001 Alternator	294
12.152 FK	110 - 114 kW		12/88→05/94	10/92→; -05/94; ☺ D0826F02; 55A	8EL 725 625-001 Alternator	292
				10/92→; -05/94; ☺ D0826F01; 55A	8EL 725 736-001 Alternator	294
				10/92→; -05/94; ☺ D0826F02; 55A	8EL 725 736-001 Alternator	294
				10/92→; -05/94; ☺ D0826F01; 35A	8EL 730 008-001 Alternator	294
				10/92→; -05/94; ☺ D0826F02; 35A	8EL 730 008-001 Alternator	294
12.192 F, 12.192 FL 14.192 F, 14.192 FL 14.192 FK 14.192 FS, 14.192 FLS 17.192 FA	140 kW 140 kW 140 kW 140 kW 140 kW		07/90→06/96 07/90→06/96 07/90→06/96 07/90→06/96 07/90→06/96	☺ D0826LF05; 55A	8EL 725 625-001 Alternator	292
				☺ D0826LF07; 55A	8EL 725 625-001 Alternator	292
				☺ D0826LF01; 55A	8EL 725 625-001 Alternator	292
				☺ D0826LF01; 55A	8EL 725 736-001 Alternator	294
				☺ D0826LF05; 55A	8EL 725 736-001 Alternator	294
				☺ D0826LF07; 55A	8EL 725 736-001 Alternator	294
				06/92→; -04/94; ☺ D0826LF05; 35A	8EL 730 008-001 Alternator	294
				07/90→; -04/94; ☺ D0826LF01; 35A	8EL 730 008-001 Alternator	294
				05/94→; -06/96; ☺ D0826LF07; 35A	8EL 731 715-001 Alternator	295
				☺ D0826LF01; 80A	8EL 732 707-001 Alternator	295
				☺ D0826LF05; 80A	8EL 732 707-001 Alternator	295
				☺ D0826LF07; 80A	8EL 732 707-001 Alternator	295
				12.192 FA 12.192 FAK	140 kW 140 kW	
☺ D0826LF07; 55A	8EL 725 625-001 Alternator	292				
☺ D0826LF07; 55A	8EL 725 736-001 Alternator	294				
☺ D0826LF05; 55A	8EL 725 736-001 Alternator	294				
10/92→; -04/94; ☺ D0826LF05; 35A	8EL 730 008-001 Alternator	294				
05/94→; -06/96; ☺ D0826LF07; 35A	8EL 731 715-001 Alternator	295				

Manufacturer - Model	Power	Displ.	Year of Constr.	Remark	Part Number	Page
MAN - M 90					08/88→06/96	
12.192 FA	140 kW		10/92→06/96	☞ D0826LF05; 80A	8EL 732 707-001 Alternator	295
12.192 FAK	140 kW		10/92→06/96	☞ D0826LF07; 80A	8EL 732 707-001 Alternator	295
12.192 FK	140 kW		07/90→06/96	☞ D0826LF05; 55A	8EL 725 625-001 Alternator	292
				☞ D0826LF07; 55A	8EL 725 625-001 Alternator	292
				☞ D0826LF01; 55A	8EL 725 625-001 Alternator	292
				☞ D0826LF01; 55A	8EL 725 736-001 Alternator	294
				☞ D0826LF05; 55A	8EL 725 736-001 Alternator	294
				☞ D0826LF07; 55A	8EL 725 736-001 Alternator	294
				06/92→; →04/94; ☞ D0826LF05; 35A	8EL 730 008-001 Alternator	294
				05/94→; →06/96; ☞ D0826LF07; 35A	8EL 730 008-001 Alternator	294
				07/90→; →04/94; ☞ D0826LF01; 35A	8EL 730 008-001 Alternator	294
				☞ D0826LF01; 80A	8EL 732 707-001 Alternator	295
				☞ D0826LF05; 80A	8EL 732 707-001 Alternator	295
				☞ D0826LF07; 80A	8EL 732 707-001 Alternator	295
				12.192 FS,12.192 FLS	140 kW	
☞ D0826LF07; 55A	8EL 725 625-001 Alternator	292				
☞ D0826LF01; 55A	8EL 725 625-001 Alternator	292				
☞ D0826LF01; 55A	8EL 725 736-001 Alternator	294				
☞ D0826LF05; 55A	8EL 725 736-001 Alternator	294				
☞ D0826LF07; 55A	8EL 725 736-001 Alternator	294				
07/90→; →04/94; ☞ D0826LF01; 35A	8EL 730 008-001 Alternator	294				
06/92→; →04/94; ☞ D0826LF05; 35A	8EL 730 008-001 Alternator	294				
05/94→; →06/96; ☞ D0826LF01; 35A	8EL 731 715-001 Alternator	295				
05/94→; →06/96; ☞ D0826LF07; 35A	8EL 731 715-001 Alternator	295				
☞ D0826LF01; 80A	8EL 732 707-001 Alternator	295				
☞ D0826LF05; 80A	8EL 732 707-001 Alternator	295				
☞ D0826LF07; 80A	8EL 732 707-001 Alternator	295				
12.222 F,12.222 FL	162 kW		05/94→06/96	☞ D0826LF11; 55A	8EL 725 625-001 Alternator	292
12.222 FA	162 kW		05/94→06/96			
12.222 FAK	162 kW		05/94→06/96	☞ D0826LF11; 55A	8EL 725 736-001 Alternator	294
12.222 FLS	162 kW		05/94→06/96			
14.222 F,14.222 FL	162 kW		05/94→06/96	☞ D0826LF11; 35A	8EL 731 715-001 Alternator	295
14.222 FK	162 kW		05/94→06/96			
14.222 FLS	162 kW		05/94→06/96			
17.222 FA	162 kW		05/94→06/96	☞ D0826LF11; 80A	8EL 732 707-001 Alternator	295
17.222 FAK	162 kW		05/94→06/96			
18.222 F,18.222 FL,18.222 FLL	162 kW		05/94→06/96			
18.222 FK	162 kW		05/94→06/96			
24.222 FNL,24.222 FNLL,24.222 FVL	162 kW		05/94→06/96			
12.222 FK	162 kW		05/94→06/96	☞ D0826LF11; 55A	8EL 725 736-001 Alternator	294
12.232 F,12.232 FL	169 kW		08/88→06/96	☞ D0826LF08; 55A	8EL 725 663-001 Alternator	293
12.232 FK	169 kW		08/88→06/96			
12.232 FS,12.232 FLS	169 kW		08/88→06/96	☞ D0826LF02; 55A	8EL 725 663-001 Alternator	293
14.232 F,14.232 FL	169 kW		08/88→06/96			
14.232 FK	169 kW		08/88→06/96	☞ D0826LF06; 55A	8EL 725 663-001 Alternator	293
14.232 FS,14.232 FLS	169 kW		08/88→06/96			

Manufacturer - Model	Power	Displ.	Year of Constr.	Remark	Part Number	Page
MAN - M 90					08/88→06/96	
12.232 F,12.232 FL	169 kW		08/88→06/96	☺ D0826LF08; 55A	8EL 725 736-001 Alternator	294
12.232 FK	169 kW		08/88→06/96			
12.232 FS,12.232 FLS	169 kW		08/88→06/96	☺ D0826LF02; 55A	8EL 725 736-001 Alternator	294
14.232 F,14.232 FL	169 kW		08/88→06/96			
14.232 FK	169 kW		08/88→06/96	☺ D0826LF06; 55A	8EL 725 736-001 Alternator	294
14.232 FS,14.232 FLS	169 kW		08/88→06/96			
				08/88→; →10/92; ☺ D0826LF02; 35A	8EL 730 008-001 Alternator	294
				08/88→; →07/94; ☺ D0826LF08; 35A	8EL 730 008-001 Alternator	294
				08/88→; →05/94; ☺ D0826LF06; 35A	8EL 730 008-001 Alternator	294
				08/94→; →06/96; ☺ D0826LF08; 35A	8EL 731 715-001 Alternator	295
				☺ D0826LF02; 80A	8EL 732 707-001 Alternator	295
				☺ D0826LF06; 80A	8EL 732 707-001 Alternator	295
				☺ D0826LF08; 80A	8EL 732 707-001 Alternator	295
12.232 FA	169 kW		05/90→06/96	☺ D0826LF08; 55A	8EL 725 625-001 Alternator	292
12.232 FAK	169 kW		05/90→06/96			
				☺ D0826LF06; 55A	8EL 725 625-001 Alternator	292
				☺ D0826LF02; 55A	8EL 725 625-001 Alternator	292
				☺ D0826LF06; 55A	8EL 725 736-001 Alternator	294
				☺ D0826LF02; 55A	8EL 725 736-001 Alternator	294
				☺ D0826LF08; 55A	8EL 725 736-001 Alternator	294
				05/90→; →04/94; ☺ D0826LF02; 35A	8EL 730 008-001 Alternator	294
				06/92→; →04/94; ☺ D0826LF06; 35A	8EL 730 008-001 Alternator	294
				05/94→; →06/96; ☺ D0826LF08; 35A	8EL 731 715-001 Alternator	295
				☺ D0826LF08; 80A	8EL 732 707-001 Alternator	295
				☺ D0826LF02; 80A	8EL 732 707-001 Alternator	295
				☺ D0826LF06; 80A	8EL 732 707-001 Alternator	295
12.262 F,12.262 FL	191 kW		08/95→06/96	☺ D0826LF13; 55A	8EL 725 625-001 Alternator	292
12.262 FK	191 kW		08/95→06/96			
12.262 FS,12.262 FLS	191 kW		08/95→06/96	☺ D0826LF13; 55A	8EL 725 736-001 Alternator	294
14.262 F,14.262 FL	191 kW		08/95→06/96			
14.262 FK	191 kW		08/95→06/96	☺ D0826LF13; 35A	8EL 731 715-001 Alternator	295
14.262 FS,14.262 FLS	191 kW		08/95→06/96			
18.262 F,18.262 FL,18.262 FLL	191 kW		08/95→06/96			
18.262 FK	191 kW		08/95→06/96	☺ D0826LF13; 80A	8EL 732 707-001 Alternator	295
24.262 FNL,24.262 FNLL,24.262 FVL	191 kW		08/95→06/96			
12.272 F,12.272 FL	198 kW		09/91→10/92	☺ D2865LF02; 35A	8EL 725 644-001 Alternator	292
12.272 FK	198 kW		09/91→10/92			
12.272 FS,12.272 FLS	198 kW		09/91→10/92	☺ D2865LF02; 55A	8EL 725 736-001 Alternator	294
14.272 F,14.272 FL	198 kW		09/91→10/92			
14.272 FK	198 kW		09/91→10/92	☺ D2865LF02; 80A	8EL 732 707-001 Alternator	295
14.272 FS,14.272 FLS	198 kW		09/91→10/92			
12.272 F,12.272 FL	198 kW		10/92→06/96	☺ D0826LF04; 55A	8EL 725 625-001 Alternator	292
12.272 FK	198 kW		10/92→06/96			
12.272 FS,12.272 FLS	198 kW		10/92→06/96	☺ D0826LF04; 55A	8EL 725 736-001 Alternator	294
14.272 F,14.272 FL	198 kW		10/92→06/96			
14.272 FK	198 kW		10/92→06/96			
18.272 F,18.272 FL,18.272 FLL	198 kW		10/92→06/96	10/92→; →04/94; ☺ D0826LF04; 35A	8EL 730 008-001 Alternator	294
18.272 FK	198 kW		10/92→06/96			
24.272 FNL,24.272 FNLL,24.272 FVL	198 kW		10/92→06/96	05/94→; →06/96; ☺ D0826LF04; 35A	8EL 731 715-001 Alternator	295
				☺ D0826LF04; 80A	8EL 732 707-001 Alternator	295

Manufacturer - Model	Power	Displ.	Year of Constr.	Remark	Part Number	Page
MAN - M 90					08/88→06/96	
12.272 FA	198 kW		10/93→04/95	☺ D0826LF04; 55A	8EL 725 736-001 Alternator	294
12.272 FAK	198 kW		10/93→04/95	☺ D0826LF04; 35A	8EL 731 715-001 Alternator	295
				☺ D0826LF04; 80A	8EL 732 707-001 Alternator	295
14.152 F,14.152 FL	110 - 114 kW		12/88→04/94	12/91→; →04/94; ☺ D0826F02; 55A	8EL 725 625-001 Alternator	292
				☺ D0826F01; 55A	8EL 725 663-001 Alternator	293
				☺ D0826F02; 55A	8EL 725 736-001 Alternator	294
				☺ D0826F02; 35A	8EL 730 008-001 Alternator	294
				12/88→; →03/92; ☺ D0826F01; 35A	8EL 730 008-001 Alternator	294
14.152 F,14.152 FL	114 kW		05/94→06/96	☺ D0824LF01; 55A	8EL 725 625-001 Alternator	292
14.152 FK	114 kW		05/94→06/96	☺ D0824LF01; 55A	8EL 725 736-001 Alternator	294
				05/94→; →05/94; ☺ D0824LF01; 35A	8EL 730 008-001 Alternator	294
				06/94→; →06/96; ☺ D0824LF01; 35A	8EL 731 715-001 Alternator	295
				☺ D0824LF01; 80A	8EL 732 707-001 Alternator	295
14.152 FK	110 - 114 kW		12/88→05/94	12/88→; →12/91; ☺ D0826F01; 55A	8EL 725 663-001 Alternator	293
14.152 FS,14.152 FLS	110 - 114 kW		12/88→05/94	12/91→; →05/94; ☺ D0826F02; 55A	8EL 725 736-001 Alternator	294
				12/88→; →12/91; ☺ D0826F01; 35A	8EL 730 008-001 Alternator	294
				12/91→; →05/94; ☺ D0826F02; 35A	8EL 730 008-001 Alternator	294
14.152 FS,14.152 FLS	114 kW		05/94→06/96	☺ D0824LF01; 55A	8EL 725 625-001 Alternator	292
				☺ D0824LF01; 55A	8EL 725 736-001 Alternator	294
				☺ D0824LF01; 35A	8EL 730 008-001 Alternator	294
				06/94→; →06/96; ☺ D0824LF01; 35A	8EL 731 715-001 Alternator	295
				☺ D0824LF01; 80A	8EL 732 707-001 Alternator	295
14.162 F,14.162 FL	118 kW		08/95→06/96	☺ D0824LF02; 55A	8EL 725 625-001 Alternator	292
14.162 FK	118 kW		08/95→06/96			
14.162 FS,14.162 FLS	118 kW		08/95→06/96	☺ D0824LF02; 55A	8EL 725 736-001 Alternator	294
				☺ D0824LF02; 35A	8EL 731 715-001 Alternator	295
				☺ D0824LF02; 80A	8EL 732 707-001 Alternator	295
14.192 F,14.192 FL	137 kW		08/88→06/90	☺ D0826TF; 55A	8EL 725 663-001 Alternator	293
14.192 FA	137 kW		08/88→06/90			
14.192 FK	137 kW		08/88→06/90	☺ D0826TF; 35A	8EL 730 008-001 Alternator	294
14.192 FS,14.192 FLS	137 kW		08/88→06/90			
17.192 F,17.192 FL	137 kW		08/88→06/90			
17.192 FA	137 kW		02/89→06/90			
17.192 FAK	137 kW		02/89→06/90			
17.192 FK	137 kW		08/88→06/90			
17.192 FS,17.192 FLS	137 kW		08/88→06/90			
14.232 F,14.232 FL	160 kW		05/90→04/95	☺ D0826LF/217/SILENT; 55A	8EL 725 736-001 Alternator	294
14.232 FS,14.232 FLS	160 kW		05/90→04/95	05/90→; →03/92; ☺ D0826LF/217/SILENT; 35A	8EL 730 008-001 Alternator	294
				04/92→; →04/95; ☺ D0826LF/217/SILENT; 35A	8EL 731 715-001 Alternator	295
				☺ D0826LF/217/SILENT; 80A	8EL 732 707-001 Alternator	295

Manufacturer - Model	Power	Displ.	Year of Constr.	Remark	Part Number	Page	
MAN - M 90				08/88→06/96			
14.272 FS,14.272 FLS	198 kW		12/92→06/96	☺ D0826LF04; 55A	8EL 725 625-001 Alternator	292	
				☺ D0826LF04; 55A	8EL 725 736-001 Alternator	294	
				12/92→; →04/94; ☺ D0826LF04; 35A	8EL 730 008-001 Alternator	294	
				05/94→; →06/96; ☺ D0826LF04; 35A	8EL 731 715-001 Alternator	295	
				☺ D0826LF04; 80A	8EL 732 707-001 Alternator	295	
17.192 F,17.192 FL 17.192 FS,17.192 FLS	140 kW		07/90→04/95	☺ D0826LF01; 55A	8EL 725 736-001 Alternator	294	
				☺ D0826LF05; 55A	8EL 725 736-001 Alternator	294	
				07/90→04/95	07/90→; →03/92; ☺ D0826LF01; 35A	8EL 730 008-001 Alternator	294
					07/90→; →03/92; ☺ D0826LF05; 35A	8EL 730 008-001 Alternator	294
					04/92→; →04/95; ☺ D0826LF05; 35A	8EL 731 715-001 Alternator	295
					04/92→; →04/95; ☺ D0826LF01; 35A	8EL 731 715-001 Alternator	295
					☺ D0826LF01; 80A	8EL 732 707-001 Alternator	295
					☺ D0826LF05; 80A	8EL 732 707-001 Alternator	295
17.192 FAK	140 kW		07/90→06/96	☺ D0826LF05; 55A	8EL 725 625-001 Alternator	292	
				☺ D0826LF07; 55A	8EL 725 625-001 Alternator	292	
				☺ D0826LF01; 55A	8EL 725 625-001 Alternator	292	
				☺ D0826LF01; 55A	8EL 725 736-001 Alternator	294	
				☺ D0826LF05; 55A	8EL 725 736-001 Alternator	294	
				07/90→; →04/94; ☺ D0826LF01; 35A	8EL 730 008-001 Alternator	294	
				06/92→; →04/94; ☺ D0826LF05; 35A	8EL 730 008-001 Alternator	294	
				05/94→; →06/96; ☺ D0826LF07; 35A	8EL 731 715-001 Alternator	295	
				☺ D0826LF01; 80A	8EL 732 707-001 Alternator	295	
				☺ D0826LF05; 80A	8EL 732 707-001 Alternator	295	
				☺ D0826LF07; 80A	8EL 732 707-001 Alternator	295	
17.192 FK	140 kW		07/90→01/91	☺ D0826LF01; 55A	8EL 725 736-001 Alternator	294	
				☺ D0826LF01; 80A	8EL 732 707-001 Alternator	295	
17.232 F,17.232 FL 17.232 FA 17.232 FAK 17.232 FS,17.232 FLS 24.232 FNL	160 kW		05/90→04/95	05/90→; →03/92; ☺ D0826LF/217/SILENT; 35A	8EL 725 644-001 Alternator	292	
				☺ D0826LF/217/SILENT; 55A	8EL 725 736-001 Alternator	294	
				05/90→04/95	04/92→; →04/95; ☺ D0826LF/217/SILENT; 35A	8EL 731 715-001 Alternator	295
					☺ D0826LF/217/SILENT; 80A	8EL 732 707-001 Alternator	295
					17.232 F,17.232 FL	169 kW	
☺ D0826LF06; 55A	8EL 725 736-001 Alternator	294					
08/88→; →03/92; ☺ D0826LF02; 35A	8EL 730 008-001 Alternator	294					
10/92→; →04/95; ☺ D0826LF06; 35A	8EL 731 715-001 Alternator	295					
04/92→; →04/95; ☺ D0826LF02; 35A	8EL 731 715-001 Alternator	295					
				☺ D0826LF02; 80A	8EL 732 707-001 Alternator	295	
				☺ D0826LF06; 80A	8EL 732 707-001 Alternator	295	

Manufacturer - Model	Power	Displ.	Year of Constr.	Remark	Part Number	Page
MAN - M 90				08/88→06/96		
17.232 FA	169 kW		02/89→06/96	02/89→; →04/95; ☺ D0826LF08; 55A	8EL 725 663-001 Alternator	293
				02/89→; →05/95; ☺ D0826LF06; 55A	8EL 725 663-001 Alternator	293
				02/89→; →04/95; ☺ D0826LF02; 55A	8EL 725 663-001 Alternator	293
				☺ D0826LF08; 55A	8EL 725 736-001 Alternator	294
				☺ D0826LF02; 55A	8EL 725 736-001 Alternator	294
				☺ D0826LF06; 55A	8EL 725 736-001 Alternator	294
				02/89→; →07/94; ☺ D0826LF08; 35A	8EL 730 008-001 Alternator	294
				02/89→; →07/94; ☺ D0826LF06; 35A	8EL 730 008-001 Alternator	294
				02/89→; →07/94; ☺ D0826LF02; 35A	8EL 730 008-001 Alternator	294
				08/94→; →06/96; ☺ D0826LF02; 35A	8EL 731 715-001 Alternator	295
				08/94→; →06/96; ☺ D0826LF08; 35A	8EL 731 715-001 Alternator	295
				08/94→; →06/96; ☺ D0826LF06; 35A	8EL 731 715-001 Alternator	295
				☺ D0826LF02; 80A	8EL 732 707-001 Alternator	295
				☺ D0826LF06; 80A	8EL 732 707-001 Alternator	295
				☺ D0826LF08; 80A	8EL 732 707-001 Alternator	295
17.232 FAK	169 kW		02/89→06/96	02/89→; →05/95; ☺ D0826LF08; 55A	8EL 725 663-001 Alternator	293
				02/89→; →05/95; ☺ D0826LF06; 55A	8EL 725 663-001 Alternator	293
				02/89→; →04/95; ☺ D0826LF02; 55A	8EL 725 663-001 Alternator	293
				☺ D0826LF08; 55A	8EL 725 736-001 Alternator	294
				☺ D0826LF02; 55A	8EL 725 736-001 Alternator	294
				☺ D0826LF06; 55A	8EL 725 736-001 Alternator	294
				02/89→; →07/94; ☺ D0826LF08; 35A	8EL 730 008-001 Alternator	294
				02/89→; →07/94; ☺ D0826LF06; 35A	8EL 730 008-001 Alternator	294
				02/89→; →07/94; ☺ D0826LF02; 35A	8EL 730 008-001 Alternator	294
				08/94→; →06/96; ☺ D0826LF02; 35A	8EL 731 715-001 Alternator	295
				08/94→; →06/96; ☺ D0826LF08; 35A	8EL 731 715-001 Alternator	295
				08/94→; →06/96; ☺ D0826LF06; 35A	8EL 731 715-001 Alternator	295
				☺ D0826LF02; 80A	8EL 732 707-001 Alternator	295
				☺ D0826LF06; 80A	8EL 732 707-001 Alternator	295
				☺ D0826LF08; 80A	8EL 732 707-001 Alternator	295
17.232 FK	160 kW		05/90→01/91	☺ D0826LF/217/SILENT; 55A	8EL 725 663-001 Alternator	293
				☺ D0826LF/217/SILENT; 55A	8EL 725 736-001 Alternator	294
				☺ D0826LF/217/SILENT; 35A	8EL 730 008-001 Alternator	294
				☺ D0826LF/217/SILENT; 80A	8EL 732 707-001 Alternator	295
17.232 FK	169 kW		08/88→01/91	☺ D0826LF02; 55A	8EL 725 736-001 Alternator	294
				☺ D0826LF02; 80A	8EL 732 707-001 Alternator	295
17.232 FS,17.232 FLS	169 kW		08/88→04/95	☺ D0826LF02; 55A	8EL 725 736-001 Alternator	294

Manufacturer - Model	Power	Displ.	Year of Constr.	Remark	Part Number	Page
MAN - M 90					08/88→06/96	
17.232 FS,17.232 FLS	169 kW		08/88→04/95	☺ D0826LF06; 55A	8EL 725 736-001 Alternator	294
				08/88→; →03/92; ☺ D0826LF02; 35A	8EL 730 008-001 Alternator	294
				10/92→; →04/95; ☺ D0826LF06; 35A	8EL 731 715-001 Alternator	295
				☺ D0826LF02; 35A	8EL 731 715-001 Alternator	295
				☺ D0826LF02; 80A	8EL 732 707-001 Alternator	295
				☺ D0826LF06; 80A	8EL 732 707-001 Alternator	295
17.272 FLS	198 kW		09/91→05/95	09/91→; →10/93; ☺ D2865LF02; 35A	8EL 725 644-001 Alternator	292
				☺ D2865LF02; 55A	8EL 725 736-001 Alternator	294
				11/93→; →05/95; ☺ D2865LF02; 35A	8EL 731 715-001 Alternator	295
				☺ D2865LF02; 80A	8EL 732 707-001 Alternator	295
17.272 FLS	198 kW		10/92→05/95	☺ D0826LF04; 55A	8EL 725 736-001 Alternator	294
				10/92→; →07/94; ☺ D0826LF04; 35A	8EL 730 008-001 Alternator	294
				08/94→; →05/95; ☺ D0826LF04; 35A	8EL 731 715-001 Alternator	295
				☺ D0826LF04; 80A	8EL 732 707-001 Alternator	295
18.192 F,18.192 FL,18.192 FLL 18.192 FK	140 kW 140 kW		09/90→06/96 09/90→06/96	☺ D0826LF05; 55A	8EL 725 625-001 Alternator	292
				☺ D0826LF07; 55A	8EL 725 625-001 Alternator	292
				☺ D0826LF01; 55A	8EL 725 625-001 Alternator	292
				☺ D0826LF01; 55A	8EL 725 736-001 Alternator	294
				☺ D0826LF05; 55A	8EL 725 736-001 Alternator	294
				☺ D0826LF07; 55A	8EL 725 736-001 Alternator	294
				06/92→; →04/94; ☺ D0826LF05; 35A	8EL 730 008-001 Alternator	294
				09/90→; →04/94; ☺ D0826LF01; 35A	8EL 730 008-001 Alternator	294
				05/94→; →06/96; ☺ D0826LF07; 35A	8EL 731 715-001 Alternator	295
				☺ D0826LF01; 80A	8EL 732 707-001 Alternator	295
				☺ D0826LF05; 80A	8EL 732 707-001 Alternator	295
				☺ D0826LF07; 80A	8EL 732 707-001 Alternator	295
				18.232 F,18.232 FL,18.232 FLL 18.232 FK	169 kW 169 kW	
☺ D0826LF06; 55A	8EL 725 625-001 Alternator	292				
☺ D0826LF02; 55A	8EL 725 625-001 Alternator	292				
☺ D0826LF02; 55A	8EL 725 736-001 Alternator	294				
☺ D0826LF06; 55A	8EL 725 736-001 Alternator	294				
☺ D0826LF08; 55A	8EL 725 736-001 Alternator	294				
09/90→; →04/94; ☺ D0826LF02; 35A	8EL 730 008-001 Alternator	294				
06/92→; →04/94; ☺ D0826LF06; 35A	8EL 730 008-001 Alternator	294				
05/94→; →06/96; ☺ D0826LF08; 35A	8EL 731 715-001 Alternator	295				
☺ D0826LF08; 80A	8EL 732 707-001 Alternator	295				
☺ D0826LF06; 80A	8EL 732 707-001 Alternator	295				

Manufacturer - Model	Power	Displ.	Year of Constr.	Remark	Part Number	Page
MAN - M 90					08/88→06/96	
18.232 F, 18.232 FL, 18.232 FLL 18.232 FK	169 kW 169 kW		09/90→06/96 09/90→06/96	☺ D0826LF02; 80A	8EL 732 707-001 Alternator	295
18.272 F, 18.272 FL, 18.272 FLL 18.272 FK	198 kW 198 kW		09/91→05/94 09/91→05/94	09/91→; →10/93; ☺ D2865LF02; 35A	8EL 725 644-001 Alternator	292
24.272 FNL, 24.272 FVL	198 kW		09/91→05/94	☺ D2865LF02; 55A	8EL 725 736-001 Alternator	294
				11/93→; →05/94; ☺ D2865LF02; 35A	8EL 731 715-001 Alternator	295
				☺ D2865LF02; 80A	8EL 732 707-001 Alternator	295
24.192 FNL, 24.192 FNLL, 24.192 FVL	140 kW		07/89→06/96	☺ D0826LF05; 55A	8EL 725 736-001 Alternator	294
				☺ D0826LF01; 55A	8EL 725 736-001 Alternator	294
				☺ D0826LF07; 55A	8EL 725 736-001 Alternator	294
				07/89→; →10/92; ☺ D0826LF01; 35A	8EL 730 008-001 Alternator	294
				07/89→; →05/94; ☺ D0826LF05; 35A	8EL 730 008-001 Alternator	294
				07/89→; →07/94; ☺ D0826LF07; 35A	8EL 730 008-001 Alternator	294
				08/94→; →06/96; ☺ D0826LF07; 35A	8EL 731 715-001 Alternator	295
				☺ D0826LF01; 80A	8EL 732 707-001 Alternator	295
				☺ D0826LF05; 80A	8EL 732 707-001 Alternator	295
				☺ D0826LF07; 80A	8EL 732 707-001 Alternator	295
24.232 FNL, 24.232 FNLL, 24.232 FVL	169 kW		07/89→06/96	☺ D0826LF06; 55A	8EL 725 625-001 Alternator	292
				☺ D0826LF08; 55A	8EL 725 625-001 Alternator	292
				☺ D0826LF02; 55A	8EL 725 736-001 Alternator	294
				☺ D0826LF06; 55A	8EL 725 736-001 Alternator	294
				☺ D0826LF08; 55A	8EL 725 736-001 Alternator	294
				06/92→; →04/94; ☺ D0826LF06; 35A	8EL 730 008-001 Alternator	294
				07/89→; →10/92; ☺ D0826LF02; 35A	8EL 730 008-001 Alternator	294
				05/94→; →06/96; ☺ D0826LF08; 35A	8EL 731 715-001 Alternator	295
				☺ D0826LF08; 80A	8EL 732 707-001 Alternator	295
				☺ D0826LF02; 80A	8EL 732 707-001 Alternator	295
				☺ D0826LF06; 80A	8EL 732 707-001 Alternator	295
MAN - M 2000 L					08/95→	
12.163 LC, LLC, LRC, LLRC 12.163 LK, LRK	114 kW 114 kW		08/95→ 08/95→	08/95→; →08/01; ☺ D0824LFL06; 55A	8EL 725 736-001 Alternator	294
14.163 LC, LLC, LRC, LLRC 14.163 LK, LRK	114 kW 114 kW		08/95→ 08/95→	08/95→; →08/01; ☺ D0824LFL09; 55A	8EL 725 736-001 Alternator	294
				08/95→; →08/01; ☺ D0824LFL09; 35A	8EL 731 715-001 Alternator	295
				08/95→; →08/01; ☺ D0824LFL06; 35A	8EL 731 715-001 Alternator	295
				08/95→; →08/01; ☺ D0824LFL06; 80A	8EL 732 707-001 Alternator	295
				08/95→; →08/01; ☺ D0824LFL09; 80A	8EL 732 707-001 Alternator	295
12.185 LC, LLC, LRC, LLRC	132 - 136 kW		05/01→	☺ D0834LFL03; 90A	8EL 737 985-001 Alternator	296
				☺ D0834LFL03; 55A	8EL 738 055-001 Alternator	297

Manufacturer - Model	Power	Displ.	Year of Constr.	Remark	Part Number	Page											
MAN - M 2000 L						08/95→											
12.224, 12.225, LK, LRK	162 kW		08/95→	08/95→; →08/01; ⚡ D0826LFL03; 55A	8EL 725 736-001 Alternator	294											
				08/95→; →08/01; ⚡ D0826LFL10; 55A	8EL 725 736-001 Alternator	294											
				08/95→; →08/01; ⚡ D0826LFL10; 35A	8EL 731 715-001 Alternator	295											
				08/95→; →08/01; ⚡ D0826LFL03; 35A	8EL 731 715-001 Alternator	295											
				08/95→; →08/01; ⚡ D0826LFL03; 80A	8EL 732 707-001 Alternator	295											
				08/95→; →08/01; ⚡ D0826LFL10; 80A	8EL 732 707-001 Alternator	295											
12.224 LC, LLC, LRC, LLRC 14.224 LAC, LARC 14.224 LAK, LARK 14.224 LC, LLC, LLLC, LRC, LLRC, LLLRC 14.224 LK, LRK 15.224 LC, LLC, LLLC, LRC, LLRC, LLLRC 15.224 LK, LRK 18.224, 18.225, LAC, LARC 18.224, 18.225, LAK, LARK 18.224, 18.225, LC, LLC, LLLC, LRC, LLRC, LLLRC 18.224, 18.225, LK, LK, LRK, LLRK	162 kW		08/95→	08/95→; →09/01; ⚡ D0826LFL10; 55A	8EL 725 736-001 Alternator	294											
				08/95→; →09/01; ⚡ D0826LFL03; 55A	8EL 725 736-001 Alternator	294											
				08/95→; →09/01; ⚡ D0826LFL10; 35A	8EL 731 715-001 Alternator	295											
				08/95→; →09/01; ⚡ D0826LFL03; 35A	8EL 731 715-001 Alternator	295											
				08/95→; →09/01; ⚡ D0826LFL03; 80A	8EL 732 707-001 Alternator	295											
				08/95→; →09/01; ⚡ D0826LFL10; 80A	8EL 732 707-001 Alternator	295											
				14.225 LAC, LARC, (LE220B) 14.225 LAK, LARK, (LE220B) 14.225 LC, LLC, LLLC, LRC, LLRC, LLLRC, (LE220B) 14.225 LK, LRK (LE220B)	162 kW		09/00→	07/01→; ⚡ D0836LFL02; 90A	8EL 737 985-001 Alternator	296							
								07/01→; ⚡ D0836LFL02; 55A	8EL 738 055-001 Alternator	297							
								14.255 LC, LLC, LLLC, LRC, LLRC, LLLRC, (LE250B)	180 kW	09/00→	07/01→; ⚡ D0836LFL05; 90A	8EL 737 985-001 Alternator	296				
											07/01→; ⚡ D0836LFL05; 55A	8EL 738 055-001 Alternator	297				
14.263, 14.264 LAC, LARC 14.263, 14.264 LAK, LARK 14.263, 14.264 LC, LLC, LLLC, LRC, LLRC, LLLRC 14.263, 14.264 LK, LRK 15.263, 15.264 LC, LLC, LLLC, LRC, LLRC, LLLRC 15.263, 15.264 LK, LRK 18.263, 18.264, LAC, LARC 18.263, 18.264, LAK, LARK 18.263, 18.264, LC, LLC, LLLC, LRC, LLRC, LLLRC 18.263, 18.264, LK, LK, LRK, LLRK	191 kW		08/95→								08/95→; →09/01; ⚡ D0826LFL09; 55A	8EL 725 736-001 Alternator	294				
				08/95→; →09/01; ⚡ D0826LFL09; 35A	8EL 731 715-001 Alternator	295											
				08/95→; →09/01; ⚡ D0826LFL09; 80A	8EL 732 707-001 Alternator	295											
				14.284, 14.285, LAC, LARC 14.284, 14.285, LAK, LARK 14.284, 14.285, LA-LF 15.284 LC, LLC, LLLC, LRC, LLRC, LLLRC 15.284 LK, LRK 18.284, 18.285, LK, LK, LRK, LLRK 18.284, 18.285, L-KO, LR-KO 18.284 LAC, LARC 18.284 LAK, LARK 18.284 LC, LLC, LLLC, LRC, LLRC, LLLRC	206 kW		06/98→	06/98→; →09/01; ⚡ D0836LF01; 90A	8EL 737 985-001 Alternator	296							
								06/98→; →09/01; ⚡ D0836LF01; 55A	8EL 738 055-001 Alternator	297							
								14.284, 14.285, LK, LRK 14.284 LC, LLC, LLLC, LRC, LLRC, LLLRC	206 kW		10/98→	10/98→; →09/01; ⚡ D0836LF01; 90A	8EL 737 985-001 Alternator	296			
												10/98→; →09/01; ⚡ D0836LF01; 55A	8EL 738 055-001 Alternator	297			
												14.285 LC, LLC, LLLC, LRC, LLRC, LLLRC, (LE280B)	206 kW	09/00→	⚡ D0836LFL03; 90A	8EL 737 985-001 Alternator	296
															⚡ D0836LFL03; 55A	8EL 738 055-001 Alternator	297

Manufacturer - Model	Power	Displ.	Year of Constr.	Remark	Part Number	Page
MAN - M 2000 L						08/95→
15.163 LC, LLC, LRC	114 kW		08/95→	08/95→; →09/01; ☉ D0824LFL06; 55A	8EL 725 736-001 Alternator	294
15.163 LK, LRK	114 kW		08/95→	08/95→; →09/01; ☉ D0824LFL09; 55A	8EL 725 736-001 Alternator	294
				08/95→; →09/01; ☉ D0824LFL09; 35A	8EL 731 715-001 Alternator	295
				08/95→; →09/01; ☉ D0824LFL06; 35A	8EL 731 715-001 Alternator	295
				08/95→; →09/01; ☉ D0824LFL06; 80A	8EL 732 707-001 Alternator	295
				08/95→; →09/01; ☉ D0824LFL09; 80A	8EL 732 707-001 Alternator	295
15.225 LC, LLC, LLLC, LRC, LLRC, LLLRC, (LE220B)	162 kW		09/99→	09/00→; →09/01; ☉ D0836LFL02; 55A	8EL 725 736-001 Alternator	294
15.225 LK, LRK, (LE220B)	162 kW		09/99→	09/00→; →09/01; ☉ D0836LFL02; 35A	8EL 731 715-001 Alternator	295
				09/00→; →09/01; ☉ D0836LFL02; 80A	8EL 732 707-001 Alternator	295
				09/02→; ☉ D0836LFL02; 90A	8EL 737 985-001 Alternator	296
				09/02→; ☉ D0836LFL02; 55A	8EL 738 055-001 Alternator	297
15.255 LC, LLC, LLLC, LRC, LLRC, LLLRC, (LE250B)	180 kW		09/99→	07/01→; →08/02; ☉ D0836LFL05; 90A	8EL 737 985-001 Alternator	296
15.255 LK, LRK, (LE250B)	180 kW		09/99→	07/01→; →08/02; ☉ D0836LFL05; 55A	8EL 738 055-001 Alternator	297
15.285 LC, LLC, LLLC, LRC, LLRC, LLLRC, (LE280B)	206 kW		09/99→	09/00→; →09/01; ☉ D0836LFL03; 90A	8EL 737 985-001 Alternator	296
				09/00→; →09/01; ☉ D0836LFL03; 55A	8EL 738 055-001 Alternator	297
15.285 LK, LRK, (LE280B)	206 kW		09/99→	09/00→; →09/02; ☉ D0836LFL03; 90A	8EL 737 985-001 Alternator	296
				09/00→; →09/02; ☉ D0836LFL03; 55A	8EL 738 055-001 Alternator	297
18.224, 18.225, L-KO, LR-KO	162 kW		05/01→	55A	8EL 725 736-001 Alternator	294
20.224 LNLC, LNLLC	162 kW		05/01→			
18.255 LC, LLC, LLLC, LRC, LLRC, LLLRC, (LE250B)	180 kW		09/99→	09/02→; ☉ D0836LFL05; 90A	8EL 737 985-001 Alternator	296
				09/02→; ☉ D0836LFL05; 55A	8EL 738 055-001 Alternator	297
18.285 LAC, LARC (LE280B)	206 kW		09/99→	09/02→; ☉ D0836LFL03; 90A	8EL 737 985-001 Alternator	296
18.285 LC, LLC, LLLC, LRC, LLRC, LLLRC, (LE280B)	206 kW		09/99→	09/02→; ☉ D0836LFL03; 55A	8EL 738 055-001 Alternator	297
18.285 LAK, LARK, (LE280B)	206 kW		09/99→	07/01→; ☉ D0836LFL03; 90A	8EL 737 985-001 Alternator	296
				07/01→; ☉ D0836LFL03; 55A	8EL 738 055-001 Alternator	297
MAN - M 2000 M						08/95→
14.224 MAK	162 kW		08/95→12/05	08/95→; →03/97; ☉ D0826LF15; 55A	8EL 725 736-001 Alternator	294
14.224 MC, MLC, MLLC	162 kW		08/95→12/05			
14.224 MK	162 kW		08/95→12/05	08/95→; →09/01; ☉ D0826LF18; 55A	8EL 725 736-001 Alternator	294
14.224 MLS, MLRS	162 kW		08/95→12/05			
18.224 MAC, MARC	162 kW		08/95→12/05	08/95→; →03/97; ☉ D0826LF15; 35A	8EL 731 715-001 Alternator	295
18.224 MAK, MARK	162 kW		08/95→12/05			
18.224 MC, MLC, MLLC, MRC, MLRC, MLLRC	162 kW		08/95→12/05	08/95→; →09/01; ☉ D0826LF18; 35A	8EL 731 715-001 Alternator	295
18.224 MK, 18.224 MLK, MRK, MLRK	162 kW		08/95→12/05	08/95→; →03/97; ☉ D0826LF15; 80A	8EL 732 707-001 Alternator	295
18.224 MLS, MLRS	162 kW		08/95→12/05	08/95→; →09/01; ☉ D0826LF18; 80A	8EL 732 707-001 Alternator	295
14.225 MLS, MLRS	162 kW		02/03→	☉ D0836LF04; 90A	8EL 737 985-001 Alternator	296
18.225 MAC, MARC	162 kW		02/03→	☉ D0836LF04; 55A	8EL 738 055-001 Alternator	297
14.255 MLS, MLRS	180 kW		10/00→	☉ D0836LF05; 140A	8EL 737 365-001 Alternator	296
18.255 MLS, MLRS	180 kW		10/00→	☉ D0836LF05; 90A	8EL 737 985-001 Alternator	296
				☉ D0836LF05; 55A	8EL 738 055-001 Alternator	297

Manufacturer - Model	Power	Displ.	Year of Constr.	Remark	Part Number	Page
MAN - M 2000 M						08/95→
14.264 MC, MLC, MLLC	191 kW		08/95→12/05	08/95→; -09/01; ☺ D0826LF17; 55A	8EL 725 736-001 Alternator	294
14.264 MLS, MLRS	191 kW		08/95→12/05			
18.264 MAC, MARC	191 kW		08/95→12/05	08/95→; -09/01; ☺ D0826LF17; 35A	8EL 731 715-001 Alternator	295
18.264 MAK, MARK	191 kW		08/95→12/05			
18.264 MC, MLC, MLLC, MRC, MLRC, MLLRC	191 kW		08/95→12/05	08/95→; -09/01; ☺ D0826LF17; 80A	8EL 732 707-001 Alternator	295
18.264 MK, 18.264 MLK, MRK, MLRK	191 kW		08/95→12/05			
18.264 MLS, MLRS	191 kW		08/95→12/05			
14.284 MAK	206 kW		06/98→12/05	06/98→; -09/01; ☺ D0836LF01; 90A	8EL 737 985-001 Alternator	296
14.284 MA-KO, MA-LF	206 kW		06/98→12/05			
14.284 MC, MLC, MLLC	206 kW		06/98→12/05	06/98→; -09/01; ☺ D0836LF01; 55A	8EL 738 055-001 Alternator	297
14.284 MLS, MLRS	206 kW		06/98→12/05			
18.284 MAC, MARC	206 kW		06/98→12/05			
18.284 MAK, MARK	206 kW		06/98→12/05			
18.284 MC, MLC, MLLC, MRC, MLRC, LLRC	206 kW		06/98→12/05			
18.284 MK, 18.284 MLK, MRK, MLRK	206 kW		06/98→12/05			
18.284 MLS, MLRS	206 kW		06/98→12/05			
14.285 MLC, MLLC (ME280C)	206 kW		09/99→12/05	07/01→; -08/02; ☺ D0836LF03; 90A	8EL 737 985-001 Alternator	296
				07/01→; -08/02; ☺ D0836LF03; 55A	8EL 738 055-001 Alternator	297
25.224 MNLRC, MNLLC, MNLRC, MNLLRC, MVLC	162 kW		08/95→12/05	08/95→; -03/97; ☺ D0826LF18; 55A	8EL 725 736-001 Alternator	294
				08/95→; -03/97; ☺ D0826LF15; 55A	8EL 725 736-001 Alternator	294
				08/95→; -03/97; ☺ D0826LF15; 35A	8EL 731 715-001 Alternator	295
				08/95→; -03/97; ☺ D0826LF18; 35A	8EL 731 715-001 Alternator	295
				08/95→; -03/97; ☺ D0826LF15; 80A	8EL 732 707-001 Alternator	295
				08/95→; -03/97; ☺ D0826LF18; 80A	8EL 732 707-001 Alternator	295
				08/95→; -03/97; ☺ D0826LF18; 90A	8EL 737 985-001 Alternator	296
				08/95→; -03/97; ☺ D0826LF15; 90A	8EL 737 985-001 Alternator	296
				08/95→; -03/97; ☺ D0826LF15; 55A	8EL 738 055-001 Alternator	297
				08/95→; -03/97; ☺ D0826LF18; 55A	8EL 738 055-001 Alternator	297
25.264 MNLRC, MNLLC, MNLRC, MNLLRC, MVLC	191 kW		08/95→12/05	08/95→; -09/01; ☺ D0826LF17; 55A	8EL 725 736-001 Alternator	294
				08/95→; -09/01; ☺ D0826LF17; 35A	8EL 731 715-001 Alternator	295
				08/95→; -09/01; ☺ D0826LF17; 80A	8EL 732 707-001 Alternator	295
				08/95→; -09/01; ☺ D0826LF17; 90A	8EL 737 985-001 Alternator	296
				08/95→; -09/01; ☺ D0826LF17; 55A	8EL 738 055-001 Alternator	297
25.285 MNLRC, MNLLC, MNLRC, MNLLRC, MVLC	206 kW		02/03→	☺ D0836LF03; 110A	8EL 737 052-001 Alternator	296
				☺ D0836LF03; 90A	8EL 737 985-001 Alternator	296
				☺ D0836LF03; 55A	8EL 738 055-001 Alternator	297
MAN - NG						08/92→
NG 262	191 kW		06/97→07/98	☺ D2865LUH09; 140A	8EL 737 365-001 Alternator	296
NG 262, NG 263	191 kW		07/98→	07/98→; -12/01; ☺ D2866LUH22; 140A	8EL 737 365-001 Alternator	296
				07/98→; -12/01; ☺ D2866LUH22; 90A	8EL 737 985-001 Alternator	296
NG 262, NG 272	191 - 198 kW		08/92→07/98	08/92→; -09/95; ☺ D0826LUH01; 140A	8EL 737 365-001 Alternator	296
NG 312	228 kW		09/95→07/98	☺ D2865LUH07; 140A	8EL 737 365-001 Alternator	296

Manufacturer - Model	Power	Displ.	Year of Constr.	Remark	Part Number	Page
MAN - NG						08/92→
NG 312, NG 313	228 kW		07/98→	07/98→; -12/01; ⚙️ D2866LUH26; 140A	8EL 737 365-001 Alternator	296
				07/98→; -12/01; ⚙️ D2866LUH26; 90A	8EL 737 985-001 Alternator	296
MAN - NL						09/89→
NL 202	157 kW		09/89→04/94	⚙️ D0826LUH; 140A	8EL 737 365-001 Alternator	296
NL 202, NL 222, NL 223	157 - 162 kW		08/92→	11/95→; -03/97; ⚙️ D0826LUH12; 140A	8EL 737 365-001 Alternator	296
				08/92→; -09/01; ⚙️ D0826LUH12; 140A	8EL 737 365-001 Alternator	296
				08/92→; -04/01; ⚙️ D0826LUH03; 140A	8EL 737 365-001 Alternator	296
				07/98→; -09/01; ⚙️ D0826LUH12; 90A	8EL 737 985-001 Alternator	296
NL 202, NL 262, NL 263	184 kW		04/91→	04/91→; -03/97; ⚙️ D0826LUH; 140A	8EL 737 365-001 Alternator	296
NL 243	180 kW			01/02→; ⚙️ E2866DUH04; 140A	8EL 737 365-001 Alternator	296
				01/02→; ⚙️ E2866DUH04; 90A	8EL 737 985-001 Alternator	296
NL 262	191 kW		06/97→	06/97→; -07/98; ⚙️ D2865LUH09; 140A	8EL 737 365-001 Alternator	296
NL 262, NL 263	191 kW		07/98→	07/98→; -09/01; ⚙️ D2866LUH22; 140A	8EL 737 365-001 Alternator	296
				11/99→; -09/01; ⚙️ D2866LUH22; 90A	8EL 737 985-001 Alternator	296
NL 312	228 kW		11/95→07/98	⚙️ D2865LUH07; 140A	8EL 737 365-001 Alternator	296
NL 313	228 kW		07/98→	07/98→; -12/01; ⚙️ D2866LUH26; 140A	8EL 737 365-001 Alternator	296
MAN - NM						08/87→
NM 152	110 kW		05/90→10/93	⚙️ D0826OH02; 80A	8EL 732 707-001 Alternator	295
				⚙️ D0826OH02; 140A	8EL 737 365-001 Alternator	296
NM 152	114 kW		04/92→03/97	04/92→; -05/96; ⚙️ D0824LOH01; 80A	8EL 732 707-001 Alternator	295
				04/92→; -05/96; ⚙️ D0824LOH01; 140A	8EL 737 365-001 Alternator	296
NM 182, NM 192	130 - 140 kW		05/90→03/97	10/93→; -03/97; ⚙️ D0826LOH01; 55A	8EL 725 736-001 Alternator	294
				10/93→; -03/97; ⚙️ D0826LOH01; 35A	8EL 731 715-001 Alternator	295
				10/93→; -03/97; ⚙️ D0826LOH01; 80A	8EL 732 707-001 Alternator	295
				⚙️ D0826TOH; 140A	8EL 737 365-001 Alternator	296
				⚙️ D0826LOH01; 140A	8EL 737 365-001 Alternator	296
NM 222, NM 223	162 kW		02/96→	02/96→; -09/01; ⚙️ D0826LUH12; 140A	8EL 737 365-001 Alternator	296
				02/96→; -07/98; ⚙️ D0826LOH15; 140A	8EL 737 365-001 Alternator	296
NM 223	162 kW		08/87→	07/98→; -09/01; ⚙️ D0826LOH15; 140A	8EL 737 365-001 Alternator	296
MAN - NÜ						09/96→
NÜ 263	191 kW		09/96→07/98	⚙️ D2865LUH09; 140A	8EL 737 365-001 Alternator	296
NÜ 263	191 kW		07/98→	07/98→; -09/01; ⚙️ D0826LUH13; 140A	8EL 737 365-001 Alternator	296
				07/98→; -09/01; ⚙️ D2866LUH22; 140A	8EL 737 365-001 Alternator	296
NÜ 313	228 kW		07/98→	07/98→; -12/01; ⚙️ D2866LUH26; 140A	8EL 737 365-001 Alternator	296
NÜ 313 15M	228 kW		07/98→	07/98→; -06/01; ⚙️ D2866LUH26; 140A	8EL 737 365-001 Alternator	296
				07/98→; -06/01; ⚙️ D2866LUH26; 90A	8EL 737 985-001 Alternator	296

Manufacturer - Model	Power	Displ.	Year of Constr.	Remark	Part Number	Page
MAN - NÜ						09/96→
NÜ 353 15M	257 kW		07/98→	07/98→; →12/01; ⚙️ D2866LUH21; 140A	8EL 737 365-001 Alternator	296
				07/98→; →12/01; ⚙️ D2866LUH21; 90A	8EL 737 985-001 Alternator	296
MAN - R						05/85→01/93
FRH 362	265 - 274 kW		05/85→12/92	⚙️ D2866KUH; 140A	8EL 737 365-001 Alternator	296
R 292, FR 292, FRH 292	213 - 229 kW		05/85→01/93	⚙️ D2866TOH; 55A	8EL 725 736-001 Alternator	294
				⚙️ D2866TUH; 55A	8EL 725 736-001 Alternator	294
				⚙️ D2866TUH; 140A	8EL 737 365-001 Alternator	296
MAN - SD						10/85→04/94
SD 202	155 kW		10/85→04/94	10/85→; →04/91; ⚙️ D2566UH; 140A	8EL 737 365-001 Alternator	296
MAN - SG						11/84→06/97
SG 240 H,SG 242,SG 242 H	177 - 180 kW		09/85→04/94	⚙️ D2866UH; 140A	8EL 737 365-001 Alternator	296
				04/88→; →04/94; ⚙️ D2866UH; 140A	8EL 737 365-001 Alternator	296
SG 240 H,SG 292 H	213 kW		11/84→09/89	⚙️ D2866TUH; 55A	8EL 725 736-001 Alternator	294
				⚙️ D2866TUH; 140A	8EL 737 365-001 Alternator	296
				04/88→; →09/89; ⚙️ D2866TUH; 140A	8EL 737 365-001 Alternator	296
SG 242,SG 292	224 - 229 kW		09/85→04/94	⚙️ D2866TUH; 55A	8EL 725 736-001 Alternator	294
				⚙️ D2866TOH; 55A	8EL 725 736-001 Alternator	294
				⚙️ D2866TOH; 140A	8EL 737 365-001 Alternator	296
				⚙️ D2866TUH; 140A	8EL 737 365-001 Alternator	296
				04/88→; →04/94; ⚙️ D2866TUH; 140A	8EL 737 365-001 Alternator	296
SG 312,SG 322	228 - 235 kW		02/94→06/97	04/94→; →06/97; ⚙️ D2865LUH07; 140A	8EL 737 365-001 Alternator	296
				04/94→; →06/97; ⚙️ D2865LUH08; 140A	8EL 737 365-001 Alternator	296
MAN - SL II						06/84→04/94
SL 202	147 - 155 kW		06/84→04/93	⚙️ D2566UH; 140A	8EL 737 365-001 Alternator	296
SL 202	177 - 180 kW		06/84→04/94	⚙️ D2866UH; 140A	8EL 737 365-001 Alternator	296
MAN - SM						11/87→02/95
SM 152	110 - 114 kW		11/87→04/94	⚙️ D0826OH02; 140A	8EL 737 365-001 Alternator	296
SM 182,SM 192	130 - 140 kW		11/87→02/95	⚙️ D0826LOH01; 55A	8EL 725 736-001 Alternator	294
				⚙️ D0826TOH; 55A	8EL 725 736-001 Alternator	294
				⚙️ D0826TOH; 35A	8EL 731 715-001 Alternator	295
				⚙️ D0826LOH01; 35A	8EL 731 715-001 Alternator	295
				⚙️ D0826LOH01; 80A	8EL 732 707-001 Alternator	295
				⚙️ D0826TOH; 80A	8EL 732 707-001 Alternator	295
				⚙️ D0826TOH; 140A	8EL 737 365-001 Alternator	296
				⚙️ D0826LOH01; 140A	8EL 737 365-001 Alternator	296

Manufacturer - Model	Power	Displ.	Year of Constr.	Remark	Part Number	Page			
MAN - SÜ						01/86→			
SÜ 240	213 kW		01/86→09/89	☺ D2866TOH; 55A	8EL 725 736-001 Alternator	294			
				04/88→; →09/89; ☺ D2866TOH; 140A	8EL 737 365-001 Alternator	296			
SÜ 242	177 - 180 kW		01/87→04/93	04/88→; →04/93; ☺ D2866UH; 140A	8EL 737 365-001 Alternator	296			
SÜ 263	265 kW		09/03→	☺ D2866LUH25; 140A	8EL 737 365-001 Alternator	296			
				☺ D2866LUH25; 110A	8EL 738 211-261 Alternator	298			
SÜ 272	198 kW		04/93→05/95	☺ D2865LUH02; 140A	8EL 737 365-001 Alternator	296			
SÜ 283	206 kW		09/03→	06/04→; ☺ D0836LOH02; 140A	8EL 737 365-001 Alternator	296			
				06/04→; ☺ D0836LOH02; 90A	8EL 737 985-001 Alternator	296			
				06/04→; ☺ D0836LOH02; 55A	8EL 738 055-001 Alternator	297			
SÜ 292	229 kW		04/92→04/93	04/92→; →07/92; ☺ D2866TOH; 55A	8EL 725 736-001 Alternator	294			
SÜ 313	228 kW		09/03→	06/04→; →09/06; ☺ D2866LUH24; 110A	8EL 738 211-261 Alternator	298			
SÜ 322	235 kW		05/95→06/97	☺ D2865LUH08; 140A	8EL 737 365-001 Alternator	296			
MAN - TGA						04/00→			
18.310, 18.320 FAC, FHLC 18.310, 18.320 FAK, FAK-L, FALK, FALK-L, FHLK, FHLK/M 18.310, 18.320 FAS, FALS, FHLS, FHLS/M	228 - 235 kW		05/04→ 05/04→	05/04→; →09/06; ☺ D2066LF35; 80A	8EL 738 211-251 Alternator	297			
				05/04→; →09/06; ☺ D2066LF04; 80A	8EL 738 211-251 Alternator	297			
	228 - 235 kW		05/04→	05/04→; →09/06; ☺ D2066LF35; 110A	8EL 738 211-261 Alternator	298			
				05/04→; →09/06; ☺ D2066LF04; 110A	8EL 738 211-261 Alternator	298			
				☺ D2066LF04; 120A	8EL 738 212-291 Alternator	298			
				☺ D2066LF35; 120A	8EL 738 212-291 Alternator	298			
18.310, 18.320 FC, FLC, FLLC, FLLC/N, FLLW, FLLW/N	228 - 235 kW		05/04→	☺ D2066LF14; 120A	8EL 738 212-291 Alternator	298			
				☺ D2066LF28; 120A	8EL 738 212-291 Alternator	298			
				☺ D2066LF39; 120A	8EL 738 212-291 Alternator	298			
				☺ D2066LF04; 120A	8EL 738 212-291 Alternator	298			
				☺ D2066LF35; 120A	8EL 738 212-291 Alternator	298			
18.310, 18.320 FK, FK-L, FLK, FLK/M 26.310, 26.320 FDC, FDRC, FDC/M, FDRC/M, FDLC, FNHLC, FVHLC 26.310, 26.320 FDK, FDLK 26.310, 26.320 FDS, FDS/M, FDLS, FDRS, FDRS/M, FNHLS, FDLRS 26.310, 26.320 FNLS, FNLLS, FNLRS, FNLLRS	228 - 235 kW		05/04→	☺ D2066LF14; 80A	8EL 738 211-251 Alternator	297			
				☺ D2066LF04; 80A	8EL 738 211-251 Alternator	297			
	228 - 235 kW		05/04→	05/04→	05/04→; →09/06; ☺ D2066LF04; 80A	8EL 738 211-251 Alternator	297		
					☺ D2066LF35; 80A	8EL 738 211-251 Alternator	297		
	228 - 235 kW		05/04→	05/04→; →09/06; ☺ D2066LF04; 110A	8EL 738 211-261 Alternator	298			
				☺ D2066LF35; 110A	8EL 738 211-261 Alternator	298			
				☺ D2066LF14; 110A	8EL 738 211-261 Alternator	298			
				☺ D2066LF04; 110A	8EL 738 211-261 Alternator	298			
				☺ D2066LF14; 120A	8EL 738 212-291 Alternator	298			
				☺ D2066LF35; 120A	8EL 738 212-291 Alternator	298			
				☺ D2066LF04; 120A	8EL 738 212-291 Alternator	298			
				☺ D2066LF35; 120A	8EL 738 212-291 Alternator	298			
				☺ D2066LF04; 120A	8EL 738 212-291 Alternator	298			
				☺ D2066LF35; 120A	8EL 738 212-291 Alternator	298			
				☺ D2066LF04; 120A	8EL 738 212-291 Alternator	298			
18.310, 18.320 FLS, FLRS, FLLS, FLLRS				228 - 235 kW		05/04→	☺ D2066LF04; 80A	8EL 738 211-251 Alternator	297
							☺ D2066LF35; 80A	8EL 738 211-251 Alternator	297

Manufacturer - Model	Power	Displ.	Year of Constr.	Remark	Part Number	Page
MAN - TGA						04/00→
18.310, 18.320 FLS, FLRS, FLLS, FLLRS	228 - 235 kW		05/04→	05/04→; →09/06; ☺ D2066LF04; 80A	8EL 738 211-251 Alternator	297
				05/04→; →09/06; ☺ D2066LF04; 110A	8EL 738 211-261 Alternator	298
				☺ D2066LF35; 110A	8EL 738 211-261 Alternator	298
				☺ D2066LF04; 110A	8EL 738 211-261 Alternator	298
				☺ D2066LF35; 120A	8EL 738 212-291 Alternator	298
				☺ D2066LF04; 120A	8EL 738 212-291 Alternator	298
18.310, 18320 FC, FLC, FRC, FLLC, FLLC/N, FLLW, FLLRC, FLLRW	228 - 235 kW		04/00→		5DR 009 728-441 Alternator Regulator	298
				04/00→; →08/02; ☺ D2866LF26; 90A	8EL 737 985-001 Alternator	296
				04/00→; →09/01; ☺ D2866LF36; 90A	8EL 737 985-001 Alternator	296
				04/00→; →09/01; ☺ D2866LF36; 55A	8EL 738 055-001 Alternator	297
				04/00→; →08/02; ☺ D2866LF26; 55A	8EL 738 055-001 Alternator	297
18.310, 18320 FK, FLK, FK-L, FLRK	228 - 235 kW		12/00→		5DR 009 728-441 Alternator Regulator	298
				12/00→; →05/04; ☺ D2866LF26; 90A	8EL 737 985-001 Alternator	296
				12/00→; →09/01; ☺ D2866LF36; 90A	8EL 737 985-001 Alternator	296
				12/00→; →09/01; ☺ D2866LF36; 55A	8EL 738 055-001 Alternator	297
				12/00→; →05/04; ☺ D2866LF26; 55A	8EL 738 055-001 Alternator	297
				09/02→; →05/04; ☺ D2866LF26; 80A	8EL 738 211-021 Alternator	297
18.310 FAC, FARC 18.310 FAK, FAK-L, FALK 18.310 FAS, FARS	228 kW		09/02→		5DR 009 728-441 Alternator Regulator	298
	228 kW		09/02→	09/02→; →02/05; ☺ D2866LF26; 90A	8EL 737 985-001 Alternator	296
	228 kW		09/02→	09/02→; →02/05; ☺ D2866LF26; 55A	8EL 738 055-001 Alternator	297
	228 kW		09/02→	09/02→; →02/05; ☺ D2866LF26; 80A	8EL 738 211-021 Alternator	297
18.310 FLS, FLLS, FLLS/N, FLS-TS, FLRS, FLLRS	228 kW		04/00→		5DR 009 728-441 Alternator Regulator	298
				04/00→; →08/02; ☺ D2866LF26; 90A	8EL 737 985-001 Alternator	296
				04/00→; →09/01; ☺ D2866LF36; 90A	8EL 737 985-001 Alternator	296
				04/00→; →09/01; ☺ D2866LF36; 55A	8EL 738 055-001 Alternator	297
				04/00→; →08/02; ☺ D2866LF26; 55A	8EL 738 055-001 Alternator	297
				09/02→; ☺ D2866LF26; 80A	8EL 738 211-021 Alternator	297
18.350, 18.360 FAC, FHLC 18.350, 18.360 FAK, FAK-L, FALK, FALK-L, FHLK, FHLK/M 18.350, 18.360 FAS, FALS, FHLS, FHLS/M	257 - 265 kW		05/04→	05/04→; →09/06; ☺ D2066LF33; 80A	8EL 738 211-251 Alternator	297
	257 - 265 kW		05/04→	05/04→; →09/06; ☺ D2066LF13; 80A	8EL 738 211-251 Alternator	297
	257 - 265 kW		05/04→	05/04→; →09/06; ☺ D2066LF03; 80A	8EL 738 211-251 Alternator	297
				05/04→; →09/06; ☺ D2066LF33; 110A	8EL 738 211-261 Alternator	298
				05/04→; →09/06; ☺ D2066LF03; 110A	8EL 738 211-261 Alternator	298
				05/04→; →09/06; ☺ D2066LF13; 110A	8EL 738 211-261 Alternator	298
				05/04→; →09/06; ☺ D2066LF03; 120A	8EL 738 212-291 Alternator	298
				05/04→; →09/06; ☺ D2066LF13; 120A	8EL 738 212-291 Alternator	298
				05/04→; →09/06; ☺ D2066LF33; 120A	8EL 738 212-291 Alternator	298
				05/04→; →09/06; ☺ D2066LF33; 120A	8EL 738 212-291 Alternator	298

Manufacturer - Model	Power	Displ.	Year of Constr.	Remark	Part Number	Page
MAN - TGA						04/00→
18.350, 18.360 FC, FLC, FLLC, FLLRC, FLLC/N, FLLW, FLLW/N 18.350, 18.360 FK, FK-L, FLK, FLK/M,	257 - 265 kW		05/04→	05/04→; -09/06; ☺ D2066LF33; 80A	8EL 738 211-251 Alternator	297
			05/04→	05/04→; -09/06; ☺ D2066LF03; 80A	8EL 738 211-251 Alternator	297
	257 - 265 kW		05/04→	05/04→; -09/06; ☺ D2066LF33; 110A	8EL 738 211-261 Alternator	298
			05/04→	05/04→; -09/06; ☺ D2066LF03; 110A	8EL 738 211-261 Alternator	298
			05/04→	05/04→; -09/06; ☺ D2066LF03; 120A	8EL 738 212-291 Alternator	298
			05/04→	05/04→; -09/06; ☺ D2066LF33; 120A	8EL 738 212-291 Alternator	298
18.350 FLS, FLS/N, FLS/M, FLS-TS, FLLS, FLLS/N, FLLRS	257 kW		05/04→	05/04→; -09/06; ☺ D2066LF03; 80A	8EL 738 211-251 Alternator	297
			05/04→	05/04→; -09/06; ☺ D2066LF03; 110A	8EL 738 211-261 Alternator	298
			05/04→	05/04→; -09/06; ☺ D2066LF03; 120A	8EL 738 212-291 Alternator	298
18.360 FAC, FARC 18.360 FAK, FALK, FAK-L, FALK-L 18.360 FAS, FALS, FARS	265 kW		09/02→		5DR 009 728-441 Alternator Regulator	298
	265 kW		09/02→	09/02→; -03/04; ☺ D2866LF27; 90A	8EL 737 985-001 Alternator	296
	265 kW		09/02→	09/02→; -03/04; ☺ D2866LF27; 55A	8EL 738 055-001 Alternator	297
			09/02→	09/02→; -03/04; ☺ D2866LF27; 80A	8EL 738 211-021 Alternator	297
18.360 FC, FLC, FRC, FLLC, FLLC/N, FLLW, FLLRW	265 kW		04/00→		5DR 009 728-441 Alternator Regulator	298
			04/00→	04/00→; -03/04; ☺ D2866LF27; 140A	8EL 737 365-001 Alternator	296
			04/00→	04/00→; -03/04; ☺ D2866LF27; 90A	8EL 737 985-001 Alternator	296
			04/00→	04/00→; -03/04; ☺ D2866LF37; 90A	8EL 737 985-001 Alternator	296
			04/00→	04/00→; -03/04; ☺ D2866LF37; 55A	8EL 738 055-001 Alternator	297
			04/00→	04/00→; -03/04; ☺ D2866LF27; 55A	8EL 738 055-001 Alternator	297
			09/02→	09/02→; -03/04; ☺ D2866LF27; 80A	8EL 738 211-021 Alternator	297
18.360 FK, FLK, FK-L, FLRK	265 kW		12/00→		5DR 009 728-441 Alternator Regulator	298
			12/00→	12/00→; -03/04; ☺ D2866LF27; 90A	8EL 737 985-001 Alternator	296
			12/00→	12/00→; -03/04; ☺ D2866LF37; 90A	8EL 737 985-001 Alternator	296
			12/00→	12/00→; -03/04; ☺ D2866LF37; 55A	8EL 738 055-001 Alternator	297
			12/00→	12/00→; -03/04; ☺ D2866LF27; 55A	8EL 738 055-001 Alternator	297
			09/02→	09/02→; -03/04; ☺ D2866LF27; 80A	8EL 738 211-021 Alternator	297
18.360 FLS, FLLS, FLLS/N, FLS-TS, FLRS, FLLRS	265 kW		04/00→		5DR 009 728-441 Alternator Regulator	298
			04/00→	04/00→; -03/04; ☺ D2866LF37; 90A	8EL 737 985-001 Alternator	296
			04/00→	04/00→; -03/04; ☺ D2866LF27; 90A	8EL 737 985-001 Alternator	296
			04/00→	04/00→; -03/04; ☺ D2866LF37; 55A	8EL 738 055-001 Alternator	297
			04/00→	04/00→; -03/04; ☺ D2866LF27; 55A	8EL 738 055-001 Alternator	297
			09/02→	09/02→; -03/04; ☺ D2866LF27; 80A	8EL 738 211-021 Alternator	297
18.360 FLS, FLLS, FLRS, FLLRS	265 kW		01/06→	☺ D2066LF07; 110A	8EL 738 211-261 Alternator	298
				☺ D2066LF27; 110A	8EL 738 211-261 Alternator	298
				☺ D2066LF38; 110A	8EL 738 211-261 Alternator	298
18.390, 18.400 FAC, FHLC 18.390, 18.400 FAS, FALS, FHLS, FHLS/M	287 - 294 kW		05/04→	☺ D2066LF02; 80A	8EL 738 211-251 Alternator	297
	287 - 294 kW		05/04→	☺ D2066LF12; 80A	8EL 738 211-251 Alternator	297

Manufacturer - Model	Power	Displ.	Year of Constr.	Remark	Part Number	Page
MAN - TGA						04/00→
26.390, 26.400 FDHC, FDHC/M, FDHLC	287 - 294 kW		06/05→	☞ D2066LF32; 80A	8EL 738 211-251 Alternator	297
26.390, 26.400 FDHK, FDHLK	287 - 294 kW		06/05→	☞ D2066LF02; 110A	8EL 738 211-261 Alternator	298
26.390, 26.400 FDHS, FDHS/M, FDHLS	287 - 294 kW		06/05→	☞ D2066LF32; 110A	8EL 738 211-261 Alternator	298
26.390, 26.400 FD-TM	287 - 294 kW		05/04→	☞ D2066LF12; 110A	8EL 738 211-261 Alternator	298
26.390, 26.400 FVL-KO	287 - 294 kW		02/04→			
32.390, 32.400 FFDRC	287 - 294 kW		05/04→	☞ D2066LF12; 110A	8EL 738 211-261 Alternator	298
32.390, 32.400 FFD-TM, FFDRTM	287 - 294 kW		05/04→	☞ D2066LF32; 120A	8EL 738 212-291 Alternator	298
33.390, 33.400 FDAC, FDHC, FDHC/M	287 - 295 kW		06/05→	☞ D2066LF02; 120A	8EL 738 212-291 Alternator	298
33.390, 33.400 FDAK, FDHK	287 - 295 kW		06/05→	☞ D2066LF12; 120A	8EL 738 212-291 Alternator	298
33.390, 33.400 FDAS, FDHS, FDHS/M	287 - 295 kW		06/05→			
33.390, 33.400 FDC, FDLK, FDRK	287 - 294 kW		05/04→			
33.390, 33.400 FDK, FDLK, FDRK	287 - 294 kW		05/04→			
33.390, 33.400 FDS, FDLK, FDLRS, FDRS, FDS/M	287 - 294 kW		05/04→			
18.390, 18.400 FAK, FAK-L, FALK, FALK-L, FHLK, FHLK/M	287 - 294 kW		05/04→	☞ D2066LF02; 80A	8EL 738 211-251 Alternator	297
				☞ D2066LF12; 80A	8EL 738 211-251 Alternator	297
				☞ D2066LF32; 80A	8EL 738 211-251 Alternator	297
				☞ D2066LF32; 110A	8EL 738 211-261 Alternator	298
				☞ D2066LF12; 110A	8EL 738 211-261 Alternator	298
				☞ D2066LF02; 110A	8EL 738 211-261 Alternator	298
18.390, 18.400 FC, FLC, FLLC, FLLC/N, FLLW, FLLW/N	287 - 294 kW		05/04→	☞ D2066LF02; 80A	8EL 738 211-251 Alternator	297
				☞ D2066LF12; 80A	8EL 738 211-251 Alternator	297
				☞ D2066LF32; 80A	8EL 738 211-251 Alternator	297
				☞ D2066LF02; 110A	8EL 738 211-261 Alternator	298
				☞ D2066LF32; 110A	8EL 738 211-261 Alternator	298
				☞ D2066LF12; 110A	8EL 738 211-261 Alternator	298
				☞ D2066LF32; 120A	8EL 738 212-291 Alternator	298
				☞ D2066LF12; 120A	8EL 738 212-291 Alternator	298
18.390, 18.400 FK, FK-L, FLK, FLK/M	287 - 294 kW		05/04→	☞ D2066LF02; 80A	8EL 738 211-251 Alternator	297
26.390, 26.400 FVHL-KO	287 - 294 kW		06/05→	☞ D2066LF32; 80A	8EL 738 211-251 Alternator	297
				☞ D2066LF02; 110A	8EL 738 211-261 Alternator	298
				☞ D2066LF32; 110A	8EL 738 211-261 Alternator	298
				☞ D2066LF32; 120A	8EL 738 212-291 Alternator	298
				☞ D2066LF02; 120A	8EL 738 212-291 Alternator	298
18.390 FLS, FLS-TS, FLS/M, FLLS, FLLS/N, FLLS/M, FLLRS	287 kW		05/04→	☞ D2066LF02; 80A	8EL 738 211-251 Alternator	297
				☞ D2066LF02; 110A	8EL 738 211-261 Alternator	298
				☞ D2066LF02; 120A	8EL 738 212-291 Alternator	298
18.400 FLS, FLLS, FLRS, FLLRS	294 kW		10/05→	☞ D2066LF37; 80A	8EL 738 211-251 Alternator	297
				☞ D2066LF26; 80A	8EL 738 211-251 Alternator	297

Manufacturer - Model	Power	Displ.	Year of Constr.	Remark	Part Number	Page
MAN - TGA						04/00→
18.410, 18420 FAK, FAK-L, FALK	301 - 309 kW		09/02→		5DR 009 728-441 Alternator Regulator	298
18.410 FAC, FARC	301 kW		09/02→			
18.410 FAS, FALS, FARS	301 kW		09/02→	09/02→; →12/05; ⚙️ D2866LF28; 90A	8EL 737 985-001 Alternator	296
				09/02→; →12/05; ⚙️ D2866LF28; 55A	8EL 738 055-001 Alternator	297
				09/02→; →12/05; ⚙️ D2866LF28; 80A	8EL 738 211-021 Alternator	297
18.410, 18420 FC, FRC, FLC, FLRC, FLLC, FLLC/N, FLLW, FLLRC	301 - 309 kW		04/00→		5DR 009 728-441 Alternator Regulator	298
				09/02→; →12/05; ⚙️ D2866LF28; 90A	8EL 737 985-001 Alternator	296
				04/00→; →03/04; ⚙️ D2866LF32; 90A	8EL 737 985-001 Alternator	296
				09/02→; →12/05; ⚙️ D2866LF28; 55A	8EL 738 055-001 Alternator	297
				04/00→; →03/04; ⚙️ D2866LF32; 55A	8EL 738 055-001 Alternator	297
				09/02→; →12/05; ⚙️ D2866LF28; 80A	8EL 738 211-021 Alternator	297
18.410, 18420 FK, FK-L, FLK, FLRK	301 - 309 kW		12/00→		5DR 009 728-441 Alternator Regulator	298
				12/00→; →03/04; ⚙️ D2866LF28; 90A	8EL 737 985-001 Alternator	296
				12/00→; →03/04; ⚙️ D2866LF32; 90A	8EL 737 985-001 Alternator	296
				12/00→; →03/04; ⚙️ D2866LF32; 55A	8EL 738 055-001 Alternator	297
				12/00→; →03/04; ⚙️ D2866LF28; 55A	8EL 738 055-001 Alternator	297
				09/02→; →03/04; ⚙️ D2866LF28; 80A	8EL 738 211-021 Alternator	297
18.410 FLS, FLLS, FLLS/N, FLS-TS, FLRS, FLLRS	301 kW		04/00→		5DR 009 728-441 Alternator Regulator	298
				04/00→; →12/05; ⚙️ D2866LF28; 90A	8EL 737 985-001 Alternator	296
				04/00→; →03/04; ⚙️ D2866LF32; 90A	8EL 737 985-001 Alternator	296
				04/00→; →03/04; ⚙️ D2866LF32; 55A	8EL 738 055-001 Alternator	297
				04/00→; →12/05; ⚙️ D2866LF28; 55A	8EL 738 055-001 Alternator	297
				09/02→; →12/05; ⚙️ D2866LF28; 80A	8EL 738 211-021 Alternator	297
18.430, 18.440 FAC, FHLC	316 - 324 kW		05/04→	⚙️ D2066LF01; 80A	8EL 738 211-251 Alternator	297
18.430, 18.440 FAK, FALK, FALK-L, FHLK, FHLK/M	316 - 324 kW		05/04→	⚙️ D2066LF11; 80A	8EL 738 211-251 Alternator	297
18.430, 18.440 FAS, FALS, FHLS, FHLS/M	316 - 324 kW		05/04→	⚙️ D2066LF31; 80A	8EL 738 211-251 Alternator	297
26.430, 26.440 FDHC, FDHC/M, FDHLC	316 - 324 kW		06/05→	⚙️ D2066LF01; 110A	8EL 738 211-261 Alternator	298
26.430, 26.440 FDHK, FDHLK	316 - 324 kW		06/05→	⚙️ D2066LF31; 110A	8EL 738 211-261 Alternator	298
26.430, 26.440 FDHS, FDHS/M, FDHLS	316 - 324 kW		06/05→	⚙️ D2066LF11; 110A	8EL 738 211-261 Alternator	298
26.430, 26.440 FDH-TM	316 - 324 kW		06/05→	⚙️ D2066LF31; 120A	8EL 738 212-291 Alternator	298
26.430, 26.440 FDS, FDLS, FDRS, FDLRS, FNHLS, FPHLS, FVHLS	316 - 324 kW		02/04→	⚙️ D2066LF11; 120A	8EL 738 212-291 Alternator	298
26.430, 26.440 FD-TM	316 - 324 kW		05/04→	⚙️ D2066LF01; 120A	8EL 738 212-291 Alternator	298
26.430, 26.440 FVLH-KO	316 - 324 kW		06/05→			
32.430, 32.440 FFDR	316 - 324 kW		05/04→			
32.430, 32.440 FFD-TM, FFDR-TM	316 - 324 kW		05/04→			
33.430, 33.440 FDAC, FDALC, FDHC, FDHC/M	316 - 324 kW		06/05→			
33.430, 33.440 FDAK, FDALK, FDHK	316 - 324 kW		06/05→			
33.430, 33.440 FDAS, FDALS, FDHS	316 - 324 kW		06/05→			
33.430, 33.440 FDC, FDLC, FDRC, FDLRC, FDC/M	316 - 324 kW		05/04→			
33.430, 33.440 FDK, FDLK, FDRK	316 - 324 kW		05/04→			
33.430, 33.440 FDS, FDLS, FDRS, FDLRS, FDS/M	316 - 324 kW		05/04→			

Manufacturer - Model	Power	Displ.	Year of Constr.	Remark	Part Number	Page
MAN - TGA						04/00→
18.430, 18.440 FC, FLC, FLLC, FLLW, FLLW/N, FLLRC, FLLRW	316 - 324 kW		05/04→	☺ D2066LF01; 80A	8EL 738 211-251 Alternator	297
18.430, 18.440 FK, FK-L, FLK, FLK/M	316 - 324 kW		05/04→	☺ D2066LF31; 80A	8EL 738 211-251 Alternator	297
				☺ D2066LF01; 110A	8EL 738 211-261 Alternator	298
				☺ D2066LF31; 110A	8EL 738 211-261 Alternator	298
				☺ D2066LF31; 120A	8EL 738 212-291 Alternator	298
				☺ D2066LF01; 120A	8EL 738 212-291 Alternator	298
18.430 FLS, FLS/M, FLS-TS, FLLS, FLLS/N, FLLRS, FLRS	316 kW		05/04→	☺ D2066LF01; 80A	8EL 738 211-251 Alternator	297
				☺ D2066LF01; 110A	8EL 738 211-261 Alternator	298
				☺ D2066LF01; 120A	8EL 738 212-291 Alternator	298
18.440 FLS, FLLS, FLRS, FLLRS	324 kW		09/05→	☺ D2066LF25; 110A	8EL 738 211-261 Alternator	298
28.440 FNLS, FNLRS-WW	324 kW		09/05→	☺ D2066LF36; 110A	8EL 738 211-261 Alternator	298
18.460 FC, FLC, FRC, FLLC, FLLC/N, FLLW, FLLRC, FLLRW	338 kW		04/00→		5DR 009 728-441 Alternator Regulator	298
18.460 FLS, FLLS, FLLS/N, FLS-TS, FLRS, FLLRS	338 kW		04/00→	04/00→; -05/04; ☺ D2876LF04; 90A	8EL 737 985-001 Alternator	296
				04/00→; -05/04; ☺ D2876LF07; 90A	8EL 737 985-001 Alternator	296
				04/00→; -05/04; ☺ D2876LF07; 55A	8EL 738 055-001 Alternator	297
				04/00→; -05/04; ☺ D2876LF04; 55A	8EL 738 055-001 Alternator	297
18.460 FK, FK-L, FLK, FLRK	338 kW		12/00→		5DR 009 728-441 Alternator Regulator	298
				12/00→; -05/04; ☺ D2876LF04; 90A	8EL 737 985-001 Alternator	296
				12/00→; -05/04; ☺ D2876LF07; 90A	8EL 737 985-001 Alternator	296
				12/00→; -05/04; ☺ D2876LF04; 55A	8EL 738 055-001 Alternator	297
				12/00→; -05/04; ☺ D2876LF07; 55A	8EL 738 055-001 Alternator	297
18.480 FAC	353 kW		02/06→	☺ D2676LF05; 110A	8EL 738 211-261 Alternator	298
				☺ D2676LF12; 110A	8EL 738 211-261 Alternator	298
18.480 FAC, FARC	353 kW		09/02→		5DR 009 728-441 Alternator Regulator	298
18.480 FAK, FAK-L, FALK	353 kW		09/02→		5DR 009 728-441 Alternator Regulator	298
28.480 FNLC, FNLLC, FNLRC	353 kW		09/02→	☺ D2876LF12; 80A	8EL 738 211-021 Alternator	297
28.480 FNLS, FNLRS	353 kW		09/02→		8EL 738 211-021 Alternator	297
33.480 FDAC, FDAC-WW, FDALC, FDARC	353 kW		09/02→		8EL 738 211-021 Alternator	297
33.480 FD-TM	353 kW		09/02→		8EL 738 211-021 Alternator	297
18.480 FAK, FALK	353 kW		02/06→	☺ D2676LF05; 110A	8EL 738 211-261 Alternator	298
26.480 FDAC, FDALC	353 kW		02/06→		8EL 738 211-261 Alternator	298
26.480 FDAK, FDALK	353 kW		02/06→		8EL 738 211-261 Alternator	298
26.480 FDAS, FDALS	353 kW		02/06→		8EL 738 211-261 Alternator	298
26.480 FVL-KO	353 kW		01/06→		8EL 738 211-261 Alternator	298
35.480 FDNLC	353 kW		07/06→		8EL 738 211-261 Alternator	298
39.480 FVNLC	353 kW		07/06→		8EL 738 211-261 Alternator	298
18.480 FAS, FALS	353 kW		02/06→	☺ D2676LF05; 80A	8EL 738 211-251 Alternator	297
28.480 FANLC	353 kW		07/06→		8EL 738 211-251 Alternator	297
35.480 FFDK, FFDHK, FFDHLK	353 kW		07/06→		8EL 738 211-251 Alternator	297
35.480 FFDH-TM	353 kW		07/06→		8EL 738 211-251 Alternator	297
35.480 FFNHLC	353 kW		11/06→		8EL 738 211-251 Alternator	297
35.480 FFNLC	353 kW		07/06→		8EL 738 211-251 Alternator	297
18.480 FAS, FALS, FARS	353 kW		09/02→		5DR 009 728-441 Alternator Regulator	298
26.410 FDAK, FDALK	301 kW		02/02→		5DR 009 728-441 Alternator Regulator	298
32.410 FFDK, FFDLC, FFDRC, FFDLRC	301 kW		01/02→		5DR 009 728-441 Alternator Regulator	298

Manufacturer - Model	Power	Displ.	Year of Constr.	Remark	Part Number	Page
MAN - TGA						04/00→
18.480 FC, FLC, FLLC, FLLRC, FLLW, FLRC	353 kW		01/06→	☺ D2676LF01; 80A	8EL 738 211-251 Alternator	297
18.480 FK, FK-L, FLK	353 kW		01/06→	☺ D2676LF01; 110A	8EL 738 211-261 Alternator	298
41.480 FFDC, FFDC, FFDC/M	353 kW		02/06→			
41.480 FFDK, FFDK	353 kW		02/06→	☺ D2676LF01; 120A	8EL 738 212-291 Alternator	298
41.480 FFD-TM	353 kW		02/06→			
18.480 FC, FLC, FLLC, FLLW, FLLRW, FLLRC	353 kW		09/02→		5DR 009 728-441 Alternator Regulator	298
				☺ D2876LF12; 90A	8EL 737 985-001 Alternator	296
				☺ D2876LF12; 80A	8EL 738 211-021 Alternator	297
18.480 FHLC	353 kW		04/06→	☺ D2676LF01; 80A	8EL 738 211-251 Alternator	297
18.480 FHLK, FHLK/M	353 kW		04/06→			
18.480 FHLS, FHLS/M	353 kW		04/06→	☺ D2676LF01; 110A	8EL 738 211-261 Alternator	298
24.480 FPLS, FPLRS	353 kW		01/06→			
26.480 FDC, FDC/M, FDL, FDLRC, FDRC, FNHLC, FVHLC, FDLRC-WW	353 kW		02/06→			
26.480 FDHC, FDHC/M, FDHLC	353 kW		02/06→			
26.480 FDHK, FDHLK	353 kW		02/06→			
26.480 FDHS, FDHS/M, FDHLS	353 kW		02/06→			
26.480 FDH-TM	353 kW		02/06→			
26.480 FDK, FDLK	353 kW		02/06→			
26.480 FDS, FDL, FDLRS, FNHLS, FPHLS, FVHLS	353 kW		02/06→			
26.480 FD-TM	353 kW		02/06→			
26.480 FVHL-KO	353 kW		02/06→			
32.480 FFDC	353 kW		02/06→			
32.480 FFD-TM, FFDR-TM	353 kW		02/06→			
33.480 FDAC, FDALC, FDHC, FDHC/M	353 kW		02/06→			
33.480 FDK, FDLK, FDHK	353 kW		02/06→			
33.480 FDAS, FDALS, FDHS	353 kW		02/06→			
18.480 FK, FLK, FK-L	353 kW		09/02→		5DR 009 728-441 Alternator Regulator	298
18.480 FLS, FLLS, FLLS/N, FLS-TS, FLRS-WW	353 kW		09/02→	07/03→; ☺ D2876LF12; 90A	8EL 737 985-001 Alternator	296
				07/03→; ☺ D2876LF12; 80A	8EL 738 211-021 Alternator	297
18.480 FLS, FLLS, FLRS, FLLRS	353 kW		01/06→	☺ D2676LF05; 80A	8EL 738 211-251 Alternator	297
				☺ D2676LF14; 80A	8EL 738 211-251 Alternator	297
18.510 FC, FLC, FRC, FLLC, FLLC/N, FLLW, FLLRC, FLLRW	375 kW		09/00→		5DR 009 728-441 Alternator Regulator	298
18.510 FLS, FLLS, FLLS/N, FLRS, FLLRS	375 kW		04/00→	☺ D2876LF05; 90A	8EL 737 985-001 Alternator	296
				☺ D2876LF05; 55A	8EL 738 055-001 Alternator	297
18.530 FC, FLC, FLLC, FLLC/N, FLLW, FLLRC, FLLRW	390 kW		09/02→		5DR 009 728-441 Alternator Regulator	298
18.530 FLS, FLLS, FLLS/N	390 kW		09/02→	☺ D2876LF13; 90A	8EL 737 985-001 Alternator	296
				☺ D2876LF13; 80A	8EL 738 211-021 Alternator	297
18.540 FLC, FLRC, FLLC, FLLRC, FLLW	397 kW		08/06→	☺ D2676LF13; 110A	8EL 738 211-261 Alternator	298
18.540 FLS, FLRS, FLLS, FLLRS	397 kW		08/06→			
26.540 FNLC, FNLLC, FNLLRC, FNLLW	397 kW		08/06→			
28.540 FNLS	397 kW		08/06→			
19.350 FS, FRS, FLS, FLRS-WW	257 kW		05/04→	☺ D2066LF03; 120A	8EL 738 212-291 Alternator	298
26.350 FDLRC-WW	257 kW		05/04→			
26.350 FDL, FDLRS, FDLRS/M, FDLRS-WW	257 kW		05/04→			
28.350 FNLS, FNLS-WW	257 kW		02/04→			
19.360 FS, FRS, FLS, FLRS-WW	265 kW		05/04→	☺ D2066LF07; 120A	8EL 738 212-291 Alternator	298
19.360 FS/M-WW, FRS/M-WW	265 kW		05/04→	☺ D2866LF37; 90A	8EL 737 985-001 Alternator	296
41.360 FFDK-WW	265 kW		09/03→	☺ D2866LF37; 55A	8EL 738 055-001 Alternator	297
19.390 FS, FRS, FLS, FLRS-WW	287 kW		05/04→	☺ D2066LF02; 120A	8EL 738 212-291 Alternator	298
41.390 FFDK	287 kW		12/04→			

Manufacturer - Model	Power	Displ.	Year of Constr.	Remark	Part Number	Page		
MAN - TGA						04/00→		
19.400 FS/M-WW, FRS/M-WW, FLS, FLRS	294 kW		05/04→	☞ D2066LF06; 120A	8EL 738 212-291 Alternator	298		
19.410 FS/M-WW, FRS/M-WW	301 kW		05/04→	☞ D2866LF32; 90A	8EL 737 985-001 Alternator	296		
				☞ D2866LF32; 55A	8EL 738 055-001 Alternator	297		
19.430 FS/M-WW, FLS, FRS, FLRS	316 kW		05/04→	☞ D2066LF01; 120A	8EL 738 212-291 Alternator	298		
26.430 FDLS, FDLS/M, FDLRS-WW	316 - 324 kW		02/04→					
19.440 FRS, FS/M-WW, FLS, FLRS	324 kW		02/06→	☞ D2676LF04; 120A	8EL 738 212-291 Alternator	298		
33.440 FDAS, FDHS	324 kW		06/05→					
33.440 FDC, FDRC	324 kW		06/05→					
33.440 FDC-TM, FDRC-TM	324 kW		09/07→					
33.440 FDK, FDRK	324 kW		06/05→					
33.440 FDS, FDRS	324 kW		06/05→					
40.440 FDAS-WW	324 kW		06/05→					
40.440 FDK-WW, FDRK	324 kW		06/05→					
40.440 FDS-WW, FDRS	324 kW		06/05→					
41.440 FFD/M	324 kW		12/04→					
41.440 FFDC, FFDC	324 kW		12/04→					
41.440 FFDC-TM, FFDC-TM	324 kW		09/07→					
41.440 FFDK, FFDK	324 kW		12/04→					
19.460 FS/M-WW, FRS/M-WW	338 kW		05/04→				☞ D2876LF07; 90A	8EL 737 985-001 Alternator
41.460 FFDC-WW, FFDC	338 kW		09/03→					
41.460 FFDK-WW	338 kW		09/03→					
19.480 FLS, FRS, FLRS-WW	353 kW		02/06→	☞ D2676LF03; 120A	8EL 738 212-291 Alternator	298		
							19.480 FS/M, FRS/M-WW	
				33.480 FDC-TM, FDRC-TM	09/07→	☞ D2676LF02; 120A	8EL 738 212-291 Alternator	298
				40.480 FDK-WW, FDRK	06/05→			
				41.480 FFDC-TM, FFDC-TM	09/07→			
19.480 FS/M-WW, FRS/M-WW	353 kW		05/04→	☞ D2876LF25; 80A	8EL 738 211-021 Alternator	297		
24.350, 24.360 FNLLC, FNLLW/N, FNLLRW	257 - 265 kW		05/04→	☞ D2066LF33; 80A	8EL 738 211-251 Alternator	297		
							26.350, 26.360 FDC, FDRC, FDC/M, FDRC/M, FDLC, FDLRC, FNHLC	
	257 - 265 kW		05/04→	☞ D2066LF13; 80A	8EL 738 211-251 Alternator	297		
							26.350, 26.360 FDS, FDS/M, FDLS, FDRS, FNHLS, FPHLS	
	257 - 265 kW		05/04→	☞ D2066LF13; 80A	8EL 738 211-251 Alternator	297		
							26.350, 26.360 FNLC, FNLLC, FNLLW, FNLR, FNLLRC	
	257 - 265 kW			05/04→	☞ D2066LF03; 80A	8EL 738 211-251 Alternator	297	
					☞ D2066LF03; 110A	8EL 738 211-261 Alternator	298	
					☞ D2066LF13; 110A	8EL 738 211-261 Alternator	298	
					☞ D2066LF33; 110A	8EL 738 211-261 Alternator	298	
					☞ D2066LF13; 110A	8EL 738 211-261 Alternator	298	
					☞ D2066LF33; 120A	8EL 738 212-291 Alternator	298	
					☞ D2066LF13; 120A	8EL 738 212-291 Alternator	298	
					☞ D2066LF03; 120A	8EL 738 212-291 Alternator	298	
☞ D2066LF33; 120A					8EL 738 212-291 Alternator	298		
☞ D2066LF13; 120A					8EL 738 212-291 Alternator	298		
24.350, 24.360 FPLS, FPLRS	257 - 265 kW		02/04→	☞ D2066LF33; 80A	8EL 738 211-251 Alternator	297		
				☞ D2066LF13; 80A	8EL 738 211-251 Alternator	297		
				☞ D2066LF33; 80A	8EL 738 211-251 Alternator	297		
				☞ D2066LF03; 80A	8EL 738 211-251 Alternator	297		
				☞ D2066LF13; 80A	8EL 738 211-251 Alternator	297		
				☞ D2066LF33; 110A	8EL 738 211-261 Alternator	298		
				☞ D2066LF03; 110A	8EL 738 211-261 Alternator	298		
				☞ D2066LF33; 110A	8EL 738 211-261 Alternator	298		
				☞ D2066LF13; 110A	8EL 738 211-261 Alternator	298		
				☞ D2066LF03; 110A	8EL 738 211-261 Alternator	298		

Manufacturer - Model	Power	Displ.	Year of Constr.	Remark	Part Number	Page				
MAN - TGA						04/00→				
24.350, 24.360 FPLS, FPLRS	257 - 265 kW		02/04→	02/04→; →09/06; ⚙️ D2066LF13; 110A	8EL 738 211-261 Alternator	298				
				⚙️ D2066LF33; 120A	8EL 738 212-291 Alternator	298				
				02/04→; →09/06; ⚙️ D2066LF03; 120A	8EL 738 212-291 Alternator	298				
				⚙️ D2066LF13; 120A	8EL 738 212-291 Alternator	298				
24.360 FNLLC/N, FNLLW, FNLLRW, FNLLRC	265 kW		09/01→		5DR 009 728-441 Alternator Regulator	298				
				11/02→; →05/04; ⚙️ D2866LF27; 90A	8EL 737 985-001 Alternator	296				
				11/02→; →05/04; ⚙️ D2866LF27; 55A	8EL 738 055-001 Alternator	297				
				11/02→; →05/04; ⚙️ D2866LF27; 80A	8EL 738 211-021 Alternator	297				
24.390, 24.400 FNLLC/N, FNLLW/N, FNLLRC, FNLLRW	287 - 294 kW		05/04→	⚙️ D2066LF12; 80A	8EL 738 211-251 Alternator	297				
				⚙️ D2066LF02; 80A	8EL 738 211-251 Alternator	297				
				⚙️ D2066LF32; 80A	8EL 738 211-251 Alternator	297				
				05/04→; →09/06; ⚙️ D2066LF12; 80A	8EL 738 211-251 Alternator	297				
				05/04→; →07/06; ⚙️ D2066LF32; 80A	8EL 738 211-251 Alternator	297				
				05/04→; →07/06; ⚙️ D2066LF32; 110A	8EL 738 211-261 Alternator	298				
				05/04→; →09/06; ⚙️ D2066LF12; 110A	8EL 738 211-261 Alternator	298				
				⚙️ D2066LF32; 110A	8EL 738 211-261 Alternator	298				
				⚙️ D2066LF12; 110A	8EL 738 211-261 Alternator	298				
				⚙️ D2066LF02; 110A	8EL 738 211-261 Alternator	298				
				⚙️ D2066LF02; 120A	8EL 738 212-291 Alternator	298				
				⚙️ D2066LF32; 120A	8EL 738 212-291 Alternator	298				
				⚙️ D2066LF12; 120A	8EL 738 212-291 Alternator	298				
				24.390, 24.400 FPLS, FPLRS	287 - 294 kW		05/04→	⚙️ D2066LF32; 80A	8EL 738 211-251 Alternator	297
								⚙️ D2066LF12; 80A	8EL 738 211-251 Alternator	297
								⚙️ D2066LF02; 80A	8EL 738 211-251 Alternator	297
05/04→; →09/06; ⚙️ D2066LF02; 80A	8EL 738 211-251 Alternator	297								
05/04→; →09/06; ⚙️ D2066LF12; 80A	8EL 738 211-251 Alternator	297								
05/04→; →07/06; ⚙️ D2066LF32; 80A	8EL 738 211-251 Alternator	297								
05/04→; →09/06; ⚙️ D2066LF02; 110A	8EL 738 211-261 Alternator	298								
05/04→; →07/06; ⚙️ D2066LF32; 110A	8EL 738 211-261 Alternator	298								
⚙️ D2066LF12; 110A	8EL 738 211-261 Alternator	298								
⚙️ D2066LF32; 110A	8EL 738 211-261 Alternator	298								
05/04→; →09/06; ⚙️ D2066LF12; 110A	8EL 738 211-261 Alternator	298								
⚙️ D2066LF02; 110A	8EL 738 211-261 Alternator	298								
⚙️ D2066LF02; 120A	8EL 738 212-291 Alternator	298								
⚙️ D2066LF32; 120A	8EL 738 212-291 Alternator	298								
⚙️ D2066LF12; 120A	8EL 738 212-291 Alternator	298								

Manufacturer - Model	Power	Displ.	Year of Constr.	Remark	Part Number	Page
MAN - TGA						04/00→
24.410 FNLLC/N, FNLLW, FNLLRW	301 kW		09/01→		5DR 009 728-441 Alternator Regulator	298
				11/02→; →05/04; ⚡ D2866LF28; 90A	8EL 737 985-001 Alternator	296
				11/02→; →05/04; ⚡ D2866LF28; 55A	8EL 738 055-001 Alternator	297
24.430, 24.440 FNLLC/N, FNLRC, FNLLW 26.430, 26.440, FNLC, FNLLC, FNLLW, FNLRC, FNLLRC, FVLC	316 - 324 kW		05/04→	⚡ D2066LF23; 80A	8EL 738 211-251 Alternator	297
				⚡ D2066LF11; 80A	8EL 738 211-251 Alternator	297
				⚡ D2066LF01; 80A	8EL 738 211-251 Alternator	297
				05/04→; →09/06; ⚡ D2066LF01; 80A	8EL 738 211-251 Alternator	297
				05/04→; →09/06; ⚡ D2066LF11; 80A	8EL 738 211-251 Alternator	297
				⚡ D2066LF31; 80A	8EL 738 211-251 Alternator	297
				05/04→; →09/06; ⚡ D2066LF11; 110A	8EL 738 211-261 Alternator	298
				05/04→; →09/06; ⚡ D2066LF01; 110A	8EL 738 211-261 Alternator	298
				⚡ D2066LF31; 110A	8EL 738 211-261 Alternator	298
				⚡ D2066LF23; 110A	8EL 738 211-261 Alternator	298
				⚡ D2066LF01; 110A	8EL 738 211-261 Alternator	298
				⚡ D2066LF11; 110A	8EL 738 211-261 Alternator	298
				⚡ D2066LF23; 120A	8EL 738 212-291 Alternator	298
				⚡ D2066LF31; 120A	8EL 738 212-291 Alternator	298
				⚡ D2066LF01; 120A	8EL 738 212-291 Alternator	298
⚡ D2066LF11; 120A	8EL 738 212-291 Alternator	298				
24.430, 24.440 FPLS, FPLRS 26.430, 26.440, FNLS, FNLLS, FNLRS, FNLLRS, FPLS, FPLRS 26.430, 26.440 FDC, FDRC, FDLC, FDLRC, FDLC/M, FNHLC, FVHLC 26.430, 26.440 FDK, FDLK	316 - 324 kW		05/04→	⚡ D2066LF11; 80A	8EL 738 211-251 Alternator	297
				⚡ D2066LF01; 80A	8EL 738 211-251 Alternator	297
				⚡ D2066LF31; 80A	8EL 738 211-251 Alternator	297
				05/04→; →09/06; ⚡ D2066LF01; 80A	8EL 738 211-251 Alternator	297
				05/04→; →09/06; ⚡ D2066LF11; 80A	8EL 738 211-251 Alternator	297
				05/04→; →09/06; ⚡ D2066LF11; 110A	8EL 738 211-261 Alternator	298
				05/04→; →09/06; ⚡ D2066LF01; 110A	8EL 738 211-261 Alternator	298
				⚡ D2066LF31; 110A	8EL 738 211-261 Alternator	298
				⚡ D2066LF11; 110A	8EL 738 211-261 Alternator	298
				⚡ D2066LF01; 110A	8EL 738 211-261 Alternator	298
				⚡ D2066LF31; 120A	8EL 738 212-291 Alternator	298
				⚡ D2066LF11; 120A	8EL 738 212-291 Alternator	298
				⚡ D2066LF01; 120A	8EL 738 212-291 Alternator	298
				⚡ D2066LF11; 120A	8EL 738 212-291 Alternator	298
				⚡ D2066LF01; 120A	8EL 738 212-291 Alternator	298
24.460 FNLLC/N, FNLLW, FNLLRC, FNLLRW	338 kW		09/01→		5DR 009 728-441 Alternator Regulator	298
				11/02→; →05/04; ⚡ D2876LF04; 90A	8EL 737 985-001 Alternator	296
				11/02→; →05/04; ⚡ D2876LF04; 55A	8EL 738 055-001 Alternator	297

Manufacturer - Model	Power	Displ.	Year of Constr.	Remark	Part Number	Page			
MAN - TGA						04/00→			
24.480 FNLLC/N, FNLLW, FNLLRC, FNLLRW	353 kW		09/02→		5DR 009 728-441 Alternator Regulator	298			
26.480 FDAK, FDALK	353 kW		09/02→	09/02→; →09/06; ⚡ D2876LF12; 80A	8EL 738 211-021 Alternator	297			
26.480 FDAS, FDALS, FDARS	353 kW		09/02→						
26.480 FDC, FDLC, FDR, FDLC/M, FDLRC-WW	353 kW		09/02→						
26.480 FNLS, FNLLS, FNLRS, FPLS, FVLS	353 kW		09/02→						
26.480 FVL-KO	353 kW		09/02→						
24.480 FNLLC/N, FNLLW/N	353 kW		01/06→	⚡ D2676LF01; 80A	8EL 738 211-251 Alternator	297			
26.480 FNLC, FNLC-WW, FNLLC, FNLLRC, FNLLW, FVLC	353 kW		02/06→						
							⚡ D2676LF12; 80A	8EL 738 211-251 Alternator	297
							⚡ D2676LF01; 110A	8EL 738 211-261 Alternator	298
				⚡ D2676LF12; 110A	8EL 738 211-261 Alternator	298			
24.510 FNLLC/N, FNLLW, FNLLRW	375 kW		09/01→		5DR 009 728-441 Alternator Regulator	298			
				11/02→; →06/03; ⚡ D2876LF05; 90A	8EL 737 985-001 Alternator	296			
				11/02→; →06/03; ⚡ D2876LF05; 55A	8EL 738 055-001 Alternator	297			
24.530 FNLLC/N, FNLLW, FNLLRW	390 kW		09/01→		5DR 009 728-441 Alternator Regulator	298			
				12/02→; →09/06; ⚡ D2876LF13; 80A	8EL 738 211-021 Alternator	297			
24.540 FNLLC/N, FLLCW/N	397 kW		01/06→	⚡ D2676LF11; 80A	8EL 738 211-251 Alternator	297			
							⚡ D2676LF11; 110A	8EL 738 211-261 Alternator	298
26.280 FNLC, FNLLC, FNLLW	206 kW		11/02→	⚡ D0836LF41; 80A	8EL 738 211-251 Alternator	297			
							⚡ D0836LF41; 110A	8EL 738 211-261 Alternator	298
26.310, 26.320 FDH, FDHC, FDHC/M	228 - 235 kW		06/05→	⚡ D2066LF04; 80A	8EL 738 211-251 Alternator	297			
26.310, 26.320 FDHK	228 - 235 kW		06/05→	⚡ D2066LF35; 80A	8EL 738 211-251 Alternator	297			
26.310, 26.320 FDHS, FDHS/M	228 - 235 kW		06/05→						
26.310, 26.320 FDH-TM	228 - 235 kW		06/05→	⚡ D2066LF04; 110A	8EL 738 211-261 Alternator	298			
26.310, 26.320 FD-TM	228 - 235 kW		06/05→						
35.310, 35.320 FFD, FFDLC	228 - 235 kW		02/04→	⚡ D2066LF35; 110A	8EL 738 211-261 Alternator	298			
35.310, 35.320 FFDK, FFDLK	228 - 235 kW		02/04→						
35.310, 35.320 FFD-TM	228 - 235 kW		02/04→	⚡ D2066LF35; 120A	8EL 738 212-291 Alternator	298			
37.310, 37.320 FFD	228 - 235 kW		12/04→						
37.310, 37.320 FFDK	228 - 235 kW		12/04→	⚡ D2066LF04; 120A	8EL 738 212-291 Alternator	298			
37.310, 37.320 FFD-TM	228 - 235 kW		12/04→						
26.310, 26.320 FNLC, FNLLC, FNLC, FNLLRC, FNLLW	228 - 235 kW		05/04→	⚡ D2066LF14; 80A	8EL 738 211-251 Alternator	297			
26.310, 26.320 FVLC	228 - 235 kW		02/04→						
26.310, 26.320 FVL-KO	228 - 235 kW		02/04→	⚡ D2066LF35; 80A	8EL 738 211-251 Alternator	297			
				⚡ D2066LF35; 110A	8EL 738 211-261 Alternator	298			
				⚡ D2066LF14; 110A	8EL 738 211-261 Alternator	298			
				⚡ D2066LF04; 110A	8EL 738 211-261 Alternator	298			
				⚡ D2066LF14; 120A	8EL 738 212-291 Alternator	298			
				⚡ D2066LF35; 120A	8EL 738 212-291 Alternator	298			
				⚡ D2066LF04; 120A	8EL 738 212-291 Alternator	298			
26.310, 26.320 FVHL-KO	228 - 235 kW		06/05→	⚡ D2066LF04; 80A	8EL 738 211-251 Alternator	297			
				⚡ D2066LF35; 80A	8EL 738 211-251 Alternator	297			
				06/05→; →09/06; ⚡ D2066LF04; 80A	8EL 738 211-251 Alternator	297			
				06/05→; →09/06; ⚡ D2066LF04; 110A	8EL 738 211-261 Alternator	298			

Manufacturer - Model	Power	Displ.	Year of Constr.	Remark	Part Number	Page
MAN - TGA						04/00→
26.310, 26.320 FVHL-KO	228 - 235 kW		06/05→	☺ D2066LF04; 110A	8EL 738 211-261 Alternator	298
				☺ D2066LF35; 110A	8EL 738 211-261 Alternator	298
				☺ D2066LF35; 120A	8EL 738 212-291 Alternator	298
				☺ D2066LF04; 120A	8EL 738 212-291 Alternator	298
				06/05→; →09/06; ☺ D2066LF04; 120A	8EL 738 212-291 Alternator	298
26.310 FDAC 26.310 FDAK 26.310 FDAS	228 kW 228 kW 228 kW		01/04→ 01/04→ 01/04→	☺ D2066LF04; 120A	8EL 738 212-291 Alternator	298
26.310 FDAC, FDARC 26.310 FDAK 26.310 FDAS, FDARS	228 kW 228 kW 228 kW		02/02→ 02/02→ 02/02→		5DR 009 728-441 Alternator Regulator	298
				02/02→; →05/04; ☺ D2866LF26; 90A	8EL 737 985-001 Alternator	296
				02/02→; →05/04; ☺ D2866LF26; 55A	8EL 738 055-001 Alternator	297
26.310 FDC, FDLC, FDRC, FDLC/M, FDLRC 26.310 FDS, FDLS, FDLs/M, FDLRS	228 kW 228 kW 228 kW		01/01→ 01/01→		5DR 009 728-441 Alternator Regulator	298
				01/01→; →05/04; ☺ D2866LF26; 90A	8EL 737 985-001 Alternator	296
				01/01→; →05/04; ☺ D2866LF26; 55A	8EL 738 055-001 Alternator	297
26.310 FDK, FDLK, FDRK	228 kW		09/02→		5DR 009 728-441 Alternator Regulator	298
				09/02→; →05/04; ☺ D2866LF26; 90A	8EL 737 985-001 Alternator	296
				09/02→; →05/04; ☺ D2866LF26; 55A	8EL 738 055-001 Alternator	297
				09/02→; →05/04; ☺ D2866LF26; 80A	8EL 738 211-021 Alternator	297
26.310 FD-TM, FDR-TM	228 kW		10/00→		5DR 009 728-441 Alternator Regulator	298
				10/00→; →05/04; ☺ D2866LF26; 90A	8EL 737 985-001 Alternator	296
				10/00→; →05/04; ☺ D2866LF26; 55A	8EL 738 055-001 Alternator	297
26.310 FNLC, FNLLC, FVLC, FNLLW, FNLRC, FNLLRW	228 kW		09/00→		5DR 009 728-441 Alternator Regulator	298
				09/00→; →05/04; ☺ D2866LF26; 90A	8EL 737 985-001 Alternator	296
				09/00→; →09/01; ☺ D2866LF36; 90A	8EL 737 985-001 Alternator	296
				09/00→; →09/01; ☺ D2866LF36; 55A	8EL 738 055-001 Alternator	297
				09/00→; →05/04; ☺ D2866LF26; 55A	8EL 738 055-001 Alternator	297
				09/02→; →05/04; ☺ D2866LF26; 80A	8EL 738 211-021 Alternator	297
26.310 FPLS, FVLS, FNLS, FNLLS, FPLRS, FNLRS, FVLRs	228 kW		12/00→		5DR 009 728-441 Alternator Regulator	298
				12/00→; →05/04; ☺ D2866LF26; 90A	8EL 737 985-001 Alternator	296
				12/00→; →05/04; ☺ D2866LF26; 55A	8EL 738 055-001 Alternator	297
				09/02→; →05/04; ☺ D2866LF26; 80A	8EL 738 211-021 Alternator	297
26.310 FVL-KO	228 kW		12/00→		5DR 009 728-441 Alternator Regulator	298
				12/00→; →05/04; ☺ D2866LF26; 90A	8EL 737 985-001 Alternator	296
				12/00→; →09/01; ☺ D2866LF36; 90A	8EL 737 985-001 Alternator	296
				12/00→; →09/01; ☺ D2866LF36; 55A	8EL 738 055-001 Alternator	297
				12/00→; →05/04; ☺ D2866LF26; 55A	8EL 738 055-001 Alternator	297
26.320 FDAC 26.320 FDAK 26.320 FDAS 28.320 FNLC, FNLLC, FNLRC	235 kW 235 kW 235 kW 235 kW		04/06→ 04/06→ 04/06→ 06/04→	☺ D2066LF39; 110A	8EL 738 211-261 Alternator	298

Manufacturer - Model	Power	Displ.	Year of Constr.	Remark	Part Number	Page
MAN - TGA						04/00→
26.330 FNLC, FNLLC, FNLLW	240 kW		11/02→	03/03→; -02/05; ☉ D0836LF44; 80A	8EL 738 211-251 Alternator	297
				03/03→; -02/05; ☉ D0836LF44; 110A	8EL 738 211-261 Alternator	298
26.350, 26.360 FDHK, FDHLK	257 - 265 kW		05/04→	☉ D2066LF03; 80A	8EL 738 211-251 Alternator	297
				☉ D2066LF13; 80A	8EL 738 211-251 Alternator	297
26.350, 26.360 FDHS, FDHS/M, FDHLS	257 - 265 kW		05/04→	☉ D2066LF33; 80A	8EL 738 211-251 Alternator	297
				☉ D2066LF33; 110A	8EL 738 211-261 Alternator	298
26.350, 26.360 FDH-TM	257 - 265 kW		05/04→			
26.350, 26.360 FD-TM	257 - 265 kW		02/04→			
32.350, 32.360 FFDR	257 - 265 kW		05/04→			
32.350, 32.360 FFD-TM, FFDR-TM	257 - 265 kW		02/04→			
33.350, 33.360 FDAC, FDHC, FDHC/M	257 - 265 kW		06/05→			
33.350, 33.360 FDAK, FDHK	257 - 265 kW		06/05→			
33.350, 33.360 FDAS, FDHS, FDHS/M	257 - 265 kW		06/05→			
33.350, 33.360 FDC, FDC/M, FDLC, FDRC	257 - 265 kW		05/04→			
33.350, 33.360 FDK, FDLK, FDRK	257 - 265 kW		05/04→			
33.350, 33.360 FDS, FDLS, FDS/M, FDRS	257 - 265 kW		05/04→			
26.350, 26.360 FDK, FDLK, FDRK	257 - 265 kW		05/04→	☉ D2066LF33; 80A	8EL 738 211-251 Alternator	297
				☉ D2066LF13; 80A	8EL 738 211-251 Alternator	297
				05/04→; -07/06; ☉ D2066LF33; 80A	8EL 738 211-251 Alternator	297
				05/04→; -09/06; ☉ D2066LF03; 80A	8EL 738 211-251 Alternator	297
				05/04→; -09/06; ☉ D2066LF13; 80A	8EL 738 211-251 Alternator	297
				05/04→; -09/06; ☉ D2066LF03; 110A	8EL 738 211-261 Alternator	298
				05/04→; -07/06; ☉ D2066LF33; 110A	8EL 738 211-261 Alternator	298
				☉ D2066LF33; 110A	8EL 738 211-261 Alternator	298
				☉ D2066LF13; 110A	8EL 738 211-261 Alternator	298
				05/04→; -09/06; ☉ D2066LF13; 110A	8EL 738 211-261 Alternator	298
				☉ D2066LF33; 120A	8EL 738 212-291 Alternator	298
				☉ D2066LF03; 120A	8EL 738 212-291 Alternator	298
				☉ D2066LF13; 120A	8EL 738 212-291 Alternator	298
				05/04→; -09/06; ☉ D2066LF13; 120A	8EL 738 212-291 Alternator	298
				05/04→; -09/06; ☉ D2066LF03; 120A	8EL 738 212-291 Alternator	298
				26.350, 26.360 FNLS, FNLLS, FNLSR, FNLLSR, FPLS, FPLSR	257 - 265 kW	
☉ D2066LF13; 80A	8EL 738 211-251 Alternator	297				
05/04→; -09/06; ☉ D2066LF03; 80A	8EL 738 211-251 Alternator	297				
05/04→; -09/06; ☉ D2066LF13; 80A	8EL 738 211-251 Alternator	297				
05/04→; -09/06; ☉ D2066LF13; 110A	8EL 738 211-261 Alternator	298				
05/04→; -09/06; ☉ D2066LF03; 110A	8EL 738 211-261 Alternator	298				
☉ D2066LF33; 110A	8EL 738 211-261 Alternator	298				
☉ D2066LF13; 110A	8EL 738 211-261 Alternator	298				
☉ D2066LF13; 120A	8EL 738 212-291 Alternator	298				
☉ D2066LF33; 120A	8EL 738 212-291 Alternator	298				
05/04→; -09/06; ☉ D2066LF03; 120A	8EL 738 212-291 Alternator	298				
05/04→; -09/06; ☉ D2066LF13; 120A	8EL 738 212-291 Alternator	298				

Manufacturer - Model	Power	Displ.	Year of Constr.	Remark	Part Number	Page
MAN - TGA						04/00→
26.350, 26.360 FNLS, FNLLS, FNLS, FNLLRS, FPLS, FPLRS	257 - 265 kW		05/04→	☺ D2066LF03; 120A	8EL 738 212-291 Alternator	298
26.350, 26.360 FVHL-KO	257 - 265 kW		06/05→	☺ D2066LF13; 80A	8EL 738 211-251 Alternator	297
				☺ D2066LF33; 80A	8EL 738 211-251 Alternator	297
				06/05→; →09/06; ☺ D2066LF03; 80A	8EL 738 211-251 Alternator	297
				06/05→; →09/06; ☺ D2066LF03; 110A	8EL 738 211-261 Alternator	298
				☺ D2066LF33; 110A	8EL 738 211-261 Alternator	298
				☺ D2066LF13; 110A	8EL 738 211-261 Alternator	298
				☺ D2066LF33; 120A	8EL 738 212-291 Alternator	298
				☺ D2066LF13; 120A	8EL 738 212-291 Alternator	298
				06/05→; →09/06; ☺ D2066LF03; 120A	8EL 738 212-291 Alternator	298
26.350, 26.360 FVL-KO	257 - 265 kW		01/04→	06/05→; ☺ D2066LF13; 80A	8EL 738 211-251 Alternator	297
				06/05→; ☺ D2066LF33; 80A	8EL 738 211-251 Alternator	297
				06/05→; ☺ D2066LF03; 80A	8EL 738 211-251 Alternator	297
				06/05→; ☺ D2066LF03; 110A	8EL 738 211-261 Alternator	298
				06/05→; ☺ D2066LF33; 110A	8EL 738 211-261 Alternator	298
				06/05→; ☺ D2066LF13; 110A	8EL 738 211-261 Alternator	298
				06/05→; ☺ D2066LF03; 120A	8EL 738 212-291 Alternator	298
				06/05→; ☺ D2066LF13; 120A	8EL 738 212-291 Alternator	298
				06/05→; ☺ D2066LF33; 120A	8EL 738 212-291 Alternator	298
26.350 FDAC	257 kW		02/04→	☺ D2066LF13; 120A	8EL 738 212-291 Alternator	298
26.350 FVLC	257 kW		01/04→	☺ D2066LF03; 120A	8EL 738 212-291 Alternator	
26.350 FVLS, FVLS, FVLS	257 kW		07/05→			
28.350 FANLC	257 kW		07/06→			
28.350 FANLK	257 kW		07/06→			
35.350 FFDHK, FFDHLK	257 kW		07/06→			
35.350 FFDH-TM	257 kW		07/06→			
35.350 FFDH-TM	257 kW		07/06→			
35.350 FFDH-TM	257 kW		07/06→			
35.350 FFDH-TM	257 kW		07/06→			
26.350 FDHC, FDHC/M	257 kW		04/05→	☺ D2066LF03; 80A	8EL 738 211-251 Alternator	297
				☺ D2066LF03; 110A	8EL 738 211-261 Alternator	298
				☺ D2066LF03; 120A	8EL 738 212-291 Alternator	298
26.350 FVHLC	257 kW		06/05→	☺ D2066LF13; 120A	8EL 738 212-291 Alternator	
26.350 FVHLS	257 kW		07/05→			
26.360 FDAC, FDARC	265 kW		02/02→	☺ D2066LF38; 110A	8EL 738 211-261 Alternator	
26.360 FVLC	265 kW		02/02→			
26.360 FVLS, FVLS, FVLS	265 kW		02/02→			
26.360 FVLS, FVLS, FVLS	265 kW		02/02→			
26.360 FVLS, FVLS, FVLS	265 kW		02/02→			
26.360 FVLS, FVLS, FVLS	265 kW		02/02→			
26.360 FVLS, FVLS, FVLS	265 kW		02/02→			
26.360 FVLS, FVLS, FVLS	265 kW		02/02→			
26.360 FVLS, FVLS, FVLS	265 kW		02/02→			
26.360 FVLS, FVLS, FVLS	265 kW		02/02→			
26.360 FVLS, FVLS, FVLS	265 kW		02/02→	09/02→; →12/05; ☺ D2866LF27; 90A	8EL 737 985-001 Alternator	296
26.360 FVLS, FVLS, FVLS	265 kW		01/01→	09/02→; →12/05; ☺ D2866LF27; 55A	8EL 738 055-001 Alternator	297
26.360 FVLS, FVLS, FVLS	265 kW		09/02→			
26.360 FVLS, FVLS, FVLS	265 kW		01/01→			
26.360 FVLS, FVLS, FVLS	265 kW		06/04→			
26.360 FVLS, FVLS, FVLS	265 kW		06/04→			
26.360 FVLS, FVLS, FVLS	265 kW		06/04→			
26.360 FVLS, FVLS, FVLS	265 kW		05/04→			
26.360 FVLS, FVLS, FVLS	265 kW		04/06→			
26.360 FVLS, FVLS, FVLS	265 kW		04/06→			
26.360 FVLS, FVLS, FVLS	265 kW		04/06→			
26.360 FVLS, FVLS, FVLS	265 kW		04/06→			
26.360 FVLS, FVLS, FVLS	265 kW		04/06→			
26.360 FVLS, FVLS, FVLS	265 kW		04/06→			
26.360 FVLS, FVLS, FVLS	265 kW		07/06→			

Manufacturer - Model	Power	Displ.	Year of Constr.	Remark	Part Number	Page
MAN - TGA						04/00→
26.360 FDLs, FDLRS-WW, FNHLS	265 kW		05/04→	☺ D2066LF38; 80A	8EL 738 211-251 Alternator	297
				☺ D2066LF07; 80A	8EL 738 211-251 Alternator	297
26.360 FDLs, FDLs/M, FDLRS, FDLRS/M, FDLRS-WW, FDRS	265 kW		09/03→	☺ D2866LF27; 90A	8EL 737 985-001 Alternator	296
				☺ D2866LF27; 55A	8EL 738 055-001 Alternator	297
26.360 FDS, FDLS, FNLS, FNLLS, FPLS, FPLRS, FVLS, FVLRS	265 kW		12/00→		5DR 009 728-441 Alternator Regulator	298
				12/00→; →12/05; ☺ D2866LF27; 90A	8EL 737 985-001 Alternator	296
				12/00→; →12/05; ☺ D2866LF27; 55A	8EL 738 055-001 Alternator	297
26.360 FNLC, FNLLC, FNLLW, FNLLRC, FNLLRW, FVLC	265 kW		09/00→		5DR 009 728-441 Alternator Regulator	298
				09/00→; →12/05; ☺ D2866LF27; 90A	8EL 737 985-001 Alternator	296
				09/00→; →09/01; ☺ D2866LF37; 90A	8EL 737 985-001 Alternator	296
				09/00→; →09/01; ☺ D2866LF37; 55A	8EL 738 055-001 Alternator	297
				09/00→; →12/05; ☺ D2866LF27; 55A	8EL 738 055-001 Alternator	297
26.360 FVL-KO	265 kW		12/00→		5DR 009 728-441 Alternator Regulator	298
				12/00→; →12/05; ☺ D2866LF27; 90A	8EL 737 985-001 Alternator	296
				12/00→; →09/01; ☺ D2866LF37; 90A	8EL 737 985-001 Alternator	296
				12/00→; →12/05; ☺ D2866LF27; 55A	8EL 738 055-001 Alternator	297
				12/00→; →09/01; ☺ D2866LF37; 55A	8EL 738 055-001 Alternator	297
26.390, 26.400 FDC, FDRC, FDLRC, FDRC/M, FDLC, FNHLC, FVHLC 26.390, 26.400 FDK, FDLK 26.390, 26.400 FDS, FDS/M, FDLS, FDLRS, FNHLS, FPHLS, FVHLS 26.390, 26.400 FNLS, FNLLS, FNLRS, FNLLRS, FPLS, FPLRS	287 - 294 kW		05/04→	☺ D2066LF12; 80A	8EL 738 211-251 Alternator	297
				☺ D2066LF02; 80A	8EL 738 211-251 Alternator	297
				☺ D2066LF32; 80A	8EL 738 211-251 Alternator	297
				05/04→; →09/06; ☺ D2066LF02; 80A	8EL 738 211-251 Alternator	297
				05/04→; →09/06; ☺ D2066LF12; 80A	8EL 738 211-251 Alternator	297
				05/04→; →09/06; ☺ D2066LF12; 110A	8EL 738 211-261 Alternator	298
				05/04→; →09/06; ☺ D2066LF02; 110A	8EL 738 211-261 Alternator	298
				☺ D2066LF32; 110A	8EL 738 211-261 Alternator	298
				☺ D2066LF12; 110A	8EL 738 211-261 Alternator	298
				☺ D2066LF02; 110A	8EL 738 211-261 Alternator	298
				☺ D2066LF32; 120A	8EL 738 212-291 Alternator	298
				☺ D2066LF02; 120A	8EL 738 212-291 Alternator	298
				☺ D2066LF12; 120A	8EL 738 212-291 Alternator	298
26.390, 26.400 FNLC, FNLLC, FNLLW, FNLLRC, FNLLRC	287 - 294 kW		05/04→	☺ D2066LF24; 80A	8EL 738 211-251 Alternator	297
				☺ D2066LF12; 80A	8EL 738 211-251 Alternator	297
				☺ D2066LF02; 80A	8EL 738 211-251 Alternator	297
				05/04→; →09/06; ☺ D2066LF02; 80A	8EL 738 211-251 Alternator	297
				05/04→; →09/06; ☺ D2066LF12; 80A	8EL 738 211-251 Alternator	297
				☺ D2066LF32; 80A	8EL 738 211-251 Alternator	297
				05/04→; →09/06; ☺ D2066LF12; 110A	8EL 738 211-261 Alternator	298

Manufacturer - Model	Power	Displ.	Year of Constr.	Remark	Part Number	Page										
MAN - TGA						04/00→										
26.390, 26.400 FNLC, FNLLC, FNLLW, FNLRC, FNLLRC	287 - 294 kW		05/04→	05/04→; →09/06; ⚡ D2066LF02; 110A	8EL 738 211-261 Alternator	298										
				⚡ D2066LF32; 110A	8EL 738 211-261 Alternator	298										
				⚡ D2066LF24; 110A	8EL 738 211-261 Alternator	298										
				⚡ D2066LF02; 110A	8EL 738 211-261 Alternator	298										
				⚡ D2066LF12; 110A	8EL 738 211-261 Alternator	298										
				⚡ D2066LF32; 120A	8EL 738 212-291 Alternator	298										
				⚡ D2066LF24; 120A	8EL 738 212-291 Alternator	298										
				⚡ D2066LF12; 120A	8EL 738 212-291 Alternator	298										
				⚡ D2066LF02; 120A	8EL 738 212-291 Alternator	298										
26.390 FDAC, FDALC 26.390 FDAK, FDALK 26.390 FDAS, FDALS 26.390 FDH-TM 26.390 FVLC 26.390 FVLS, FVLRS 28.390 FANLC 28.390 FANLK 28.390 FNLS, FNLRS 35.390 FDNLC 35.390 FFDAK 35.390 FFDAK, FFDHK, FFDHLK 35.390 FFDH-TM 35.390 FFNLC	287 kW		01/04→ 02/04→ 02/04→ 06/05→ 02/04→ 07/05→ 07/06→ 07/06→ 05/04→ 07/06→ 02/04→ 07/06→ 07/06→ 07/06→	⚡ D2066LF12; 120A	8EL 738 212-291 Alternator	298										
				⚡ D2066LF02; 120A	8EL 738 212-291 Alternator	298										
				26.400 FDAC, FDALC 26.400 FDAK, FDALK 26.400 FVLC 28.400 FANLC 35.400 FDNLC 35.400 FFDAK 35.400 FFDAK, FFDHK, FFDHLK 35.400 FFDH-TM 35.400 FFNHLC	294 kW		01/04→ 01/04→ 04/06→ 07/06→ 07/06→ 02/04→ 07/06→ 07/06→ 11/06→	⚡ D2066LF37; 110A	8EL 738 211-261 Alternator	298						
								26.400 FDAS, FDALS 26.400 FDH-TM 26.400 FVLS, FVLRS 28.400 FANLK 35.400 FFNLC 39.400 FVNLC	294 kW	01/04→ 04/06→ 04/06→ 07/06→ 07/06→ 07/06→	⚡ D2066LF37; 80A	8EL 738 211-251 Alternator	297			
											26.410 FDAC, FDARC 26.410 FDAS, FDALS, FDARS 26.410 FDC, FDLC, FDLC/M, FDLC-WW; FDRC-WW, FDLRC- WW	301 kW	02/02→ 02/02→ 01/01→		5DR 009 728-441 Alternator Regulator	298
														09/02→; →12/05; ⚡ D2866LF28; 90A	8EL 737 985-001 Alternator	296
														09/02→; →12/05; ⚡ D2866LF28; 55A	8EL 738 055-001 Alternator	297
											26.410 FDK, FDRK, FDLK, FDLRK	301 kW	09/01→			
														26.410 FDS, FDLS, FDLS/M, FDLS-WW, FDRS-WW, FDLRS- WW	301 kW	06/01→
											26.410 FNLC, FNLLC, FNLLW, FNLRC, FNLLRC, FVLC	301 kW	04/00→			
														04/00→; →12/05; ⚡ D2866LF28; 90A	8EL 737 985-001 Alternator	296
														04/00→; →09/01; ⚡ D2866LF32; 90A	8EL 737 985-001 Alternator	296
														04/00→; →09/01; ⚡ D2866LF32; 55A	8EL 738 055-001 Alternator	297
														04/00→; →12/05; ⚡ D2866LF28; 55A	8EL 738 055-001 Alternator	297
											26.410 FPLS, FPLRS, FVLS, FNLS, FNLLS	301 kW	12/00→		5DR 009 728-441 Alternator Regulator	298
12/00→; →12/05; ⚡ D2866LF28; 90A	8EL 737 985-001 Alternator	296														
12/00→; →12/05; ⚡ D2866LF28; 55A	8EL 738 055-001 Alternator	297														

Manufacturer - Model	Power	Displ.	Year of Constr.	Remark	Part Number	Page
MAN - TGA						04/00→
26.410 FVL-KO	301 kW		12/00→		5DR 009 728-441 Alternator Regulator	298
				12/00→; →12/05; ⚙️ D2866LF28; 90A	8EL 737 985-001 Alternator	296
				12/00→; →09/01; ⚙️ D2866LF32; 90A	8EL 737 985-001 Alternator	296
				12/00→; →12/05; ⚙️ D2866LF28; 55A	8EL 738 055-001 Alternator	297
				12/00→; →09/01; ⚙️ D2866LF32; 55A	8EL 738 055-001 Alternator	297
26.430 FDAC, FDALC	316 kW		01/04→	⚙️ D2066LF01; 120A	8EL 738 212-291 Alternator	298
26.430 FDAK, FDALK	316 kW		01/04→			
26.430 FDAS, FDALS	316 kW		01/04→	⚙️ D2066LF11; 120A	8EL 738 212-291 Alternator	298
26.430 FVL-KO	316 kW		12/00→			
26.430 FVLS, FVLRS	316 kW		07/05→			
28.430 FANLC	316 kW		07/06→			
28.430 FANLK	316 kW		07/06→			
28.430 FNLS, FNLRS-WW	316 kW		05/04→			
35.430 FDNLC	316 kW		07/06→			
35.430 FFDK, FFDHK, FFDHLK	316 kW		07/06→			
35.430 FFDH-TM	316 kW		07/06→			
35.430 FFNLC	316 kW		07/06→			
39.430 FVNLC	316 kW		07/06→			
41.430 FFDK	316 kW		12/04→			
26.440 FDAC, FDALC	324 kW		09/05→	⚙️ D2066LF36; 80A	8EL 738 211-251 Alternator	297
26.440 FDAK, FDALK	324 kW		01/04→			
26.440 FVLS, FVLRS	324 kW		09/05→			
35.440 FFDH-TM	324 kW		07/06→			
35.440 FFNLC	324 kW		07/06→			
41.440 FFDK	324 kW		07/06→			
26.440 FDAS, FDALS	324 kW		01/04→	⚙️ D2066LF36; 110A	8EL 738 211-261 Alternator	298
26.440 FVL-KO	324 kW		09/05→			
28.440 FANLC	324 kW		07/06→			
28.440 FANLK	324 kW		07/06→			
35.440 FDNLC	324 kW		07/06→			
35.440 FFDK, FFDHK, FFDHLK	324 kW		07/06→			
35.440 FFNLC	324 kW		11/06→			
39.440 FVNLC	324 kW		07/06→			
26.460 FDC, FDLC, FDLC/M, FDLC-WW, FDRC, FDLRC-WW	338 kW		01/01→		5DR 009 728-441 Alternator Regulator	298
26.460 FDK, FDLK, FDLRK	338 kW		01/01→	09/02→; →06/05; ⚙️ D2876LF04; 90A	8EL 737 985-001 Alternator	296
				09/02→; →06/05; ⚙️ D2876LF04; 55A	8EL 738 055-001 Alternator	297
26.460 FDS, FDLS, FDLS/M, FDLS-WW, FDRS-WW, FDLRS- WW	338 kW		06/01→		5DR 009 728-441 Alternator Regulator	298
				06/01→; →09/01; ⚙️ D2876LF07; 90A	8EL 737 985-001 Alternator	296
				06/01→; →09/01; ⚙️ D2876LF07; 55A	8EL 738 055-001 Alternator	297
26.460 FD-TM, FDR-TM	338 kW		01/01→		5DR 009 728-441 Alternator Regulator	298
				01/01→; →09/01; ⚙️ D2876LF07; 90A	8EL 737 985-001 Alternator	296
				01/01→; →09/01; ⚙️ D2876LF07; 55A	8EL 738 055-001 Alternator	297
26.460 FNLC, FNLRC, FNLLC, FNLLRW, FNLLRC	338 kW		04/00→		5DR 009 728-441 Alternator Regulator	298
				04/00→; →09/01; ⚙️ D2876LF07; 90A	8EL 737 985-001 Alternator	296
				04/00→; →06/05; ⚙️ D2876LF04; 90A	8EL 737 985-001 Alternator	296
				04/00→; →09/01; ⚙️ D2876LF07; 55A	8EL 738 055-001 Alternator	297
				04/00→; →06/05; ⚙️ D2876LF04; 55A	8EL 738 055-001 Alternator	297
26.460 FPLS, FPLRS, FVLS, FVLRS, FNLS, FNLLS, FNLRS	338 kW		12/00→		5DR 009 728-441 Alternator Regulator	298
				12/00→; →06/05; ⚙️ D2876LF04; 90A	8EL 737 985-001 Alternator	296
				12/00→; →06/05; ⚙️ D2876LF04; 55A	8EL 738 055-001 Alternator	297

Manufacturer - Model	Power	Displ.	Year of Constr.	Remark	Part Number	Page
MAN - TGA						04/00→
26.460 FVLC	338 kW		02/01→		5DR 009 728-441 Alternator Regulator	298
				09/02→; →06/05; ⚡ D2876LF04; 90A	8EL 737 985-001 Alternator	296
				09/02→; ⚡ D2876LF07; 90A	8EL 738 055-001 Alternator	296
				09/02→; →06/05; ⚡ D2876LF04; 55A	8EL 738 055-001 Alternator	297
				09/02→; ⚡ D2876LF07; 55A	8EL 738 055-001 Alternator	297
26.460 FVL-KO	338 kW		12/00→		5DR 009 728-441 Alternator Regulator	298
				12/00→; →09/01; ⚡ D2876LF07; 90A	8EL 737 985-001 Alternator	296
				12/00→; →06/05; ⚡ D2876LF04; 90A	8EL 737 985-001 Alternator	296
				12/00→; →09/01; ⚡ D2876LF07; 55A	8EL 738 055-001 Alternator	297
				12/00→; →06/05; ⚡ D2876LF04; 55A	8EL 738 055-001 Alternator	297
26.480 FDAC, FDALC, FDARC	353 kW		09/02→		5DR 009 728-441 Alternator Regulator	298
				08/03→; →09/06; ⚡ D2876LF12; 80A	8EL 738 211-021 Alternator	297
26.480 FDK, FDLK, FDLRK 26.480 FD-TM	353 kW		09/02→		5DR 009 728-441 Alternator Regulator	298
				05/03→; →09/06; ⚡ D2876LF12; 80A	8EL 738 211-021 Alternator	297
26.480 FNLC, FNLLC, FVLC, FNLLRC, FVLLW	353 kW		09/02→			
26.480 FDS, FDLS, FDLS/M, FDLRS-WW, FDRS	353 kW		09/02→		5DR 009 728-441 Alternator Regulator	298
				06/03→; →09/06; ⚡ D2876LF12; 80A	8EL 738 211-021 Alternator	297
26.480 FNLS, FNLLS, FNLRS, FPLS, FVLS, FVLRS	353 kW		02/06→	07/06→; ⚡ D2676LF12; 80A	8EL 738 211-251 Alternator	297
				⚡ D2676LF01; 80A	8EL 738 211-251 Alternator	297
				07/06→; ⚡ D2676LF12; 110A	8EL 738 211-261 Alternator	298
				⚡ D2676LF01; 110A	8EL 738 211-261 Alternator	298
26.510 FDC, FDC/M, FDRC, FDLC, FDLC/M, FDLRC 26.510 FDS, FDLS, FDLS/M, FDRS, FDLRS	375 kW		01/01→		5DR 009 728-441 Alternator Regulator	298
				09/02→; →06/03; ⚡ D2876LF05; 90A	8EL 737 985-001 Alternator	296
				09/02→; →06/03; ⚡ D2876LF05; 55A	8EL 738 055-001 Alternator	297
33.510 FDC, FDC/M, FDLC, FDRC, FDLRC 33.510 FDS, FDLS/M, FDRS, FDLRS/M	375 kW		09/02→			
26.510 FNLC, FNLLC, FNLLW, FNLLRC, FVLC 26.510 FNLS, FNLLS, FNLRS, FPLS, FVLS	375 kW		12/00→		5DR 009 728-441 Alternator Regulator	298
				12/00→; →06/03; ⚡ D2876LF05; 90A	8EL 737 985-001 Alternator	296
				12/00→; →06/03; ⚡ D2876LF05; 55A	8EL 738 055-001 Alternator	297
26.530 FDAC, FDALC 26.530 FDAK, FDALK 26.530 FDAS, FDALS 28.530 FANLC 28.530 FANLK 33.530 FDAC, FDALC 35.530 FFDAK 41.530 FFDAK	390 kW		07/06→	⚡ D2876LF13; 80A	8EL 738 211-021 Alternator	297
				09/02→		
				07/06→		
				07/06→		
				07/06→		
				09/02→		
				07/06→		
				07/06→		
26.530 FDC, FDLC, FDC/M, FDLRC 26.530 FDS, FDLS, FDLS/M, FDLRS	390 kW		01/01→		5DR 009 728-441 Alternator Regulator	298
				10/02→; ⚡ D2876LF13; 80A	8EL 738 211-021 Alternator	297

Manufacturer - Model	Power	Displ.	Year of Constr.	Remark	Part Number	Page
MAN - TGA						04/00→
26.530 FDK, FDLK, FDLRK	390 kW		09/02→		5DR 009 728-441	298
26.530 FNLC, FNLLC, FNLLW, FNLLRC, FVLC, FVLCRC	390 kW		09/02→		Alternator Regulator	
26.530 FNLS, FNLLS, FNLRS, FPLS, FVLS, FVLRS	390 kW		09/02→	☞ D2876LF13 ; 80A	8EL 738 211-021	297
28.530 FNLC, FNLLC, FNLR	390 kW		09/02→		Alternator	
28.530 FNLS, FNLRS	390 kW		09/02→			
33.530 FDAS, FDALS	390 kW		09/02→			
33.530 FDC, FDC/M, FDLC, FDRC, FDLRC	390 kW		09/02→			
28.310, 28.320 FNLC, FNLLC, FNLL-LE, FNLLR-LE	228 - 235 kW		07/06→	☞ D2066LF14 ; 80A	8EL 738 211-251	297
				☞ D2066LF04 ; 80A	8EL 738 211-251	297
				☞ D2066LF39 ; 80A	8EL 738 211-251	297
				☞ D2066LF28 ; 80A	8EL 738 211-251	297
				☞ D2066LF28 ; 110A	8EL 738 211-261	298
				☞ D2066LF39 ; 110A	8EL 738 211-261	298
				☞ D2066LF04 ; 110A	8EL 738 211-261	298
				☞ D2066LF14 ; 110A	8EL 738 211-261	298
				☞ D2066LF14 ; 120A	8EL 738 212-291	298
				☞ D2066LF28 ; 120A	8EL 738 212-291	298
				☞ D2066LF04 ; 120A	8EL 738 212-291	298
				☞ D2066LF39 ; 120A	8EL 738 212-291	298
28.310, 28.320 FNLC, FNLLC, FNLLRC, FNLLR-LE	228 - 235 kW		07/06→	☞ D2066LF14 ; 80A	8EL 738 211-251	297
				☞ D2066LF04 ; 80A	8EL 738 211-251	297
				☞ D2066LF39 ; 80A	8EL 738 211-251	297
				☞ D2066LF28 ; 80A	8EL 738 211-251	297
				☞ D2066LF28 ; 110A	8EL 738 211-261	298
				☞ D2066LF39 ; 110A	8EL 738 211-261	298
				☞ D2066LF04 ; 110A	8EL 738 211-261	298
				☞ D2066LF14 ; 110A	8EL 738 211-261	298
28.310 FNLC, FNLLC	228 kW		09/02→	☞ D2866LF26 ; 90A	8EL 737 985-001	296
35.310 FFD-TM	228 kW		11/03→	☞ D2866LF26 ; 55A	8EL 738 055-001	297
				☞ D2866LF26 ; 80A	8EL 738 211-021	297
28.310 FNLC, FNLLC, FNLR	228 kW		09/02→		5DR 009 728-441	298
					Alternator Regulator	
				☞ D2866LF26 ; 90A	8EL 737 985-001	296
				☞ D2866LF26 ; 55A	8EL 738 055-001	297
				☞ D2866LF26 ; 80A	8EL 738 211-021	297
				☞ D2066LF04 ; 120A	8EL 738 212-291	298
28.310 FNLS, FNLRS	228 kW		09/02→		5DR 009 728-441	298
					Alternator Regulator	
				☞ D2866LF26 ; 90A	8EL 737 985-001	296
				☞ D2866LF26 ; 55A	8EL 738 055-001	297
				☞ D2866LF26 ; 80A	8EL 738 211-021	297

Manufacturer - Model	Power	Displ.	Year of Constr.	Remark	Part Number	Page
MAN - TGA						04/00→
28.310 FNLS, FNLRS	228 kW		06/04→	☺ D2066LF14; 120A	8EL 738 212-291 Alternator	298
				☺ D2066LF04; 120A	8EL 738 212-291 Alternator	298
28.320 FNLS, FNLRS	235 kW		06/04→	☺ D2066LF39; 80A	8EL 738 211-251 Alternator	297
				☺ D2066LF28; 80A	8EL 738 211-251 Alternator	297
28.350, 28.360 FNLC, FNLLC, FNLL-LE	257 - 265 kW		07/06→	☺ D2066LF03; 80A	8EL 738 211-251 Alternator	297
				☺ D2066LF13; 80A	8EL 738 211-251 Alternator	297
				☺ D2066LF13; 110A	8EL 738 211-261 Alternator	298
				☺ D2066LF03; 110A	8EL 738 211-261 Alternator	298
28.350, 28.360 FNLC, FNLLC, FNLR, FNLL-LE	257 - 265 kW		06/04→	☺ D2066LF13; 80A	8EL 738 211-251 Alternator	297
				☺ D2066LF03; 80A	8EL 738 211-251 Alternator	297
				☺ D2066LF38; 80A	8EL 738 211-251 Alternator	297
				☺ D2066LF27; 80A	8EL 738 211-251 Alternator	297
				☺ D2066LF27; 110A	8EL 738 211-261 Alternator	298
				☺ D2066LF38; 110A	8EL 738 211-261 Alternator	298
				☺ D2066LF03; 110A	8EL 738 211-261 Alternator	298
				☺ D2066LF13; 110A	8EL 738 211-261 Alternator	298
28.360 FANLC	265 kW		07/06→	☺ D2866LF27; 80A	8EL 738 211-251 Alternator	297
				☺ D2866LF27; 110A	8EL 738 211-261 Alternator	298
				☺ D2066LF38; 110A	8EL 738 211-261 Alternator	298
28.360 FANLK	265 kW		07/06→	☺ D2066LF38; 80A	8EL 738 211-251 Alternator	297
				☺ D2866LF27; 110A	8EL 738 211-261 Alternator	298
28.360 FNLC, FNLLC 28.360 FNLS, FNLRS	265 kW 265 kW		09/02→ 09/02→		5DR 009 728-441 Alternator Regulator	298
				☺ D2866LF27; 90A	8EL 737 985-001 Alternator	296
	☺ D2866LF27; 55A	8EL 738 055-001 Alternator	297			
	☺ D2866LF27; 80A	8EL 738 211-021 Alternator	297			
28.360 FNLS, FNLRS-VW 35.360 FFDH-TM 35.360 FFNHL 35.360 FFNLC	265 kW 265 kW 265 kW 265 kW		04/06→ 07/06→ 07/06→ 07/06→	☺ D2066LF38; 80A	8EL 738 211-251 Alternator	297
28.390, 28.400 FNLC, FNLLC, FNLR, FNLL-LE	287 - 294 kW		06/04→	☺ D2066LF12; 80A	8EL 738 211-251 Alternator	297
				☺ D2066LF02; 80A	8EL 738 211-251 Alternator	297
				☺ D2066LF37; 80A	8EL 738 211-251 Alternator	297
				☺ D2066LF26; 80A	8EL 738 211-251 Alternator	297
				☺ D2066LF26; 110A	8EL 738 211-261 Alternator	298
				☺ D2066LF37; 110A	8EL 738 211-261 Alternator	298
				☺ D2066LF02; 110A	8EL 738 211-261 Alternator	298
				☺ D2066LF12; 110A	8EL 738 211-261 Alternator	298
			☺ D2066LF37; 120A	8EL 738 212-291 Alternator	298	

Manufacturer - Model	Power	Displ.	Year of Constr.	Remark	Part Number	Page		
MAN - TGA						04/00→		
28.390 FNLLC	353 kW		07/06→	☞ D2876LF12; 80A	8EL 738 211-021 Alternator	297		
35.480 FFDK	353 kW		07/06→					
41.480 FFDC-WW, FFDR	353 kW		06/05→					
41.480 FFDK-WW	353 kW		06/05→					
41.530 FFDK	353 kW		07/06→					
28.400 FNLS, FNLRS	294 kW		04/06→	☞ D2066LF26; 110A	8EL 738 211-261 Alternator	298		
				☞ D2066LF37; 110A	8EL 738 211-261 Alternator	298		
28.410 FANLC	301 kW		07/06→	☞ D2866LF28; 80A	8EL 738 211-021 Alternator	297		
						28.410 FANLK	301 kW	07/06→
						35.410 FFDK	301 kW	07/06→
						41.410 FFDK	301 kW	07/06→
28.410 FNLC, FNLLC	301 kW		09/02→	☞ D2866LF28; 90A	8EL 737 985-001 Alternator	296		
				☞ D2866LF28; 55A	8EL 738 055-001 Alternator	297		
				☞ D2866LF28; 80A	8EL 738 211-021 Alternator	297		
28.410 FNLC, FNLLC, FNLRC	301 kW		09/02→	☞ D2866LF28; 90A	5DR 009 728-441 Alternator Regulator	298		
						28.410 FNLS, FNLRS	301 kW	09/02→
						☞ D2866LF28; 55A	8EL 738 055-001 Alternator	297
						☞ D2866LF28; 80A	8EL 738 211-021 Alternator	297
28.430, 28.440 FNLC, FNLLC, FNLRC-WW	316 - 324 kW		06/04→	☞ D2066LF11; 80A	8EL 738 211-251 Alternator	297		
				☞ D2066LF01; 80A	8EL 738 211-251 Alternator	297		
				☞ D2066LF36; 80A	8EL 738 211-251 Alternator	297		
				☞ D2066LF25; 80A	8EL 738 211-251 Alternator	297		
				☞ D2066LF25; 110A	8EL 738 211-261 Alternator	298		
				☞ D2066LF36; 110A	8EL 738 211-261 Alternator	298		
				☞ D2066LF01; 110A	8EL 738 211-261 Alternator	298		
				☞ D2066LF11; 110A	8EL 738 211-261 Alternator	298		
28.460 FNLC, FNLLC, FNLRC	338 kW		09/02→	☞ D2876LF04; 90A	5DR 009 728-441 Alternator Regulator	298		
						28.460 FNLS, FNLRS	338 kW	09/02→
						☞ D2876LF04; 55A	8EL 738 055-001 Alternator	297
						☞ D2876LF04; 80A	8EL 738 211-021 Alternator	297
28.480 FANLK	353 kW		07/06→	☞ D2876LF12; 80A	8EL 738 211-021 Alternator	297		
				☞ D2676LF05; 80A	8EL 738 211-251 Alternator	297		
28.480 FNLC, FNLRC-WW, FNLLC	353 kW		02/06→	☞ D2676LF02; 110A	8EL 738 211-261 Alternator	298		
						28.480 FNLS, FNLRS-WW	353 kW	02/06→
						☞ D2676LF05; 110A	8EL 738 211-261 Alternator	298
28.510 FNLC, FNLLC, FNLRC	375 kW		09/02→	☞ D2676LF14; 110A	8EL 738 211-261 Alternator	298		
						28.510 FNLS, FNLRS	375 kW	09/02→
						☞ D2876LF05; 90A	8EL 737 985-001 Alternator	296
						☞ D2876LF05; 55A	8EL 738 055-001 Alternator	297
28.540 FNLC, FNLLC	397 kW		08/06→	☞ D2876LF05; 80A	8EL 738 211-021 Alternator	297		
						☞ D2676LF13; 80A	8EL 738 211-251 Alternator	297

Manufacturer - Model	Power	Displ.	Year of Constr.	Remark	Part Number	Page
MAN - TGA						04/00→
32.310 FFDC, FFDLC, FFDLRC	228 kW		01/02→		5DR 009 728-441	298
32.310 FFDK, FFDLK	228 kW		01/02→		Alternator Regulator	
32.310 FFD-TM	228 kW		01/02→	☺ D2866LF26; 90A	8EL 737 985-001	296
					Alternator	
				☺ D2866LF26; 55A	8EL 738 055-001	297
					Alternator	
32.360 FFDC, FFDLC, FFDLRC	265 kW		01/02→		5DR 009 728-441	298
32.360 FFDK, FFDLK	265 kW		01/02→		Alternator Regulator	
32.360 FFD-TM	265 kW		01/02→	09/02→; ☺ D2866LF27; 90A	8EL 737 985-001	296
					Alternator	
				09/02→; ☺ D2866LF27; 55A	8EL 738 055-001	297
					Alternator	
32.410 FFDK, FFDLK	301 kW		01/02→		5DR 009 728-441	298
32.410 FFD-TM	301 kW		01/02→		Alternator Regulator	
				09/02→; →06/05; ☺ D2866LF28; 90A	8EL 737 985-001	296
					Alternator	
				09/02→; →06/05; ☺ D2866LF28; 55A	8EL 738 055-001	297
					Alternator	
32.460 FFDC, FFDLC, FFDLRC	338 kW		01/02→		5DR 009 728-441	298
32.460 FFDK, FFDLK	338 kW		01/02→		Alternator Regulator	
32.460 FFD-TM	338 kW		01/02→	09/02→; ☺ D2876LF04; 90A	8EL 737 985-001	296
					Alternator	
				09/02→; ☺ D2876LF04; 55A	8EL 738 055-001	297
					Alternator	
32.480 FFDC, FFDLC, FFDLRC	353 kW		09/02→		5DR 009 728-441	298
32.480 FFDK, FFDLK	353 kW		09/02→		Alternator Regulator	
32.480 FFD-TM	353 kW		09/02→	05/04→; →09/05; ☺ D2876LF12; 80A	8EL 738 211-021	297
					Alternator	
33.350 FDC-TM, FDRC-TM	257 kW		09/07→	☺ D2066LF03; 80A	8EL 738 211-251	297
					Alternator	
33.360 FDAC, FDARC, FDAC-WW	265 kW		09/02→	09/02→; →05/04; ☺ D2866LF37; 90A	8EL 737 985-001	296
					Alternator	
33.360 FDAK, FDAK-WW	265 kW		09/02→	09/02→; →05/04; ☺ D2866LF27; 90A	8EL 737 985-001	296
					Alternator	
				09/02→; →05/04; ☺ D2866LF37; 55A	8EL 738 055-001	297
					Alternator	
				09/02→; →05/04; ☺ D2866LF27; 55A	8EL 738 055-001	297
					Alternator	
				09/02→; →05/04; ☺ D2866LF37; 80A	8EL 738 211-021	297
					Alternator	
				09/02→; →05/04; ☺ D2866LF27; 80A	8EL 738 211-021	297
					Alternator	
33.360 FDAS, FDAS-WW	265 kW		09/02→		5DR 009 728-441	298
					Alternator Regulator	
				☺ D2866LF37; 90A	8EL 737 985-001	296
					Alternator	
				☺ D2866LF27; 90A	8EL 737 985-001	296
					Alternator	
				☺ D2866LF27; 55A	8EL 738 055-001	297
					Alternator	
				☺ D2866LF37; 55A	8EL 738 055-001	297
					Alternator	
33.360 FDC, FDC-WW, FDLRC/M, FDRC-WW, FDLRC	265 kW		10/00→		5DR 009 728-441	298
					Alternator Regulator	
				☺ D2866LF37; 90A	8EL 737 985-001	296
					Alternator	
				09/02→; ☺ D2866LF27; 90A	8EL 737 985-001	296
					Alternator	
				☺ D2866LF37; 55A	8EL 738 055-001	297
					Alternator	
				09/02→; ☺ D2866LF27; 55A	8EL 738 055-001	297
					Alternator	
33.360 FDC-TM, FDRC-TM	265 kW		09/07→	☺ D2066LF07; 110A	8EL 738 211-261	298
41.360 FFD	265 kW		12/08→		Alternator	

Manufacturer - Model	Power	Displ.	Year of Constr.	Remark	Part Number	Page
MAN - TGA						04/00→
33.360 FDK, FDK-WW, FDLK, FDRK-WW	265 kW		01/01→		5DR 009 728-441 Alternator Regulator	298
				09/02→; -05/04; ⚙️ D2866LF27; 90A	8EL 737 985-001 Alternator	296
				⚙️ D2866LF37; 90A	8EL 737 985-001 Alternator	296
				09/02→; -05/04; ⚙️ D2866LF37; 55A	8EL 738 055-001 Alternator	297
				09/02→; -05/04; ⚙️ D2866LF27; 55A	8EL 738 055-001 Alternator	297
				09/02→; -05/04; ⚙️ D2866LF27; 80A	8EL 738 211-021 Alternator	297
33.360 FDS, FDS-WW, FDLs, FDLRS, FDRS-WW	265 kW		10/00→		5DR 009 728-441 Alternator Regulator	298
				⚙️ D2866LF37; 90A	8EL 737 985-001 Alternator	296
				09/02→; -12/05; ⚙️ D2866LF27; 90A	8EL 737 985-001 Alternator	296
				⚙️ D2866LF37; 55A	8EL 738 055-001 Alternator	297
				09/02→; -12/05; ⚙️ D2866LF27; 55A	8EL 738 055-001 Alternator	297
33.360 FD-TM, FDR-TM	265 kW		01/01→		5DR 009 728-441 Alternator Regulator	298
				09/02→; -05/04; ⚙️ D2866LF27; 90A	8EL 737 985-001 Alternator	296
				09/02→; -05/04; ⚙️ D2866LF27; 55A	8EL 738 055-001 Alternator	297
				09/02→; -05/04; ⚙️ D2866LF27; 80A	8EL 738 211-021 Alternator	297
33.390, 33.400 FDC-TM, FDRC-TM	287 - 294 kW		09/07→	⚙️ D2066LF06; 110A	8EL 738 211-261 Alternator	298
				⚙️ D2066LF02; 110A	8EL 738 211-261 Alternator	298
33.410 FDAC, FDAC-WW, FDALC 33.410 FDAK, FDAK-WW, FDALK 33.410 FDAS, FDAS-WW, FDALS	301 kW		09/02→		5DR 009 728-441 Alternator Regulator	298
			09/02→	⚙️ D2866LF28; 90A	8EL 737 985-001 Alternator	296
			09/02→	⚙️ D2866LF28; 55A	8EL 738 055-001 Alternator	297
33.410 FDC, FDC-WW, FDLc, FDLRC, FDRC-WW	301 kW		10/00→	09/02→; -05/04; ⚙️ D2866LF32; 90A	8EL 737 985-001 Alternator	296
				09/02→; -05/04; ⚙️ D2866LF28; 90A	8EL 737 985-001 Alternator	296
				09/02→; -05/04; ⚙️ D2866LF32; 55A	8EL 738 055-001 Alternator	297
				09/02→; -05/04; ⚙️ D2866LF28; 55A	8EL 738 055-001 Alternator	297
				09/02→; -05/04; ⚙️ D2866LF32; 80A	8EL 738 211-021 Alternator	297
				09/02→; -05/04; ⚙️ D2866LF28; 80A	8EL 738 211-021 Alternator	297
33.410 FDK, FDK-WW, FDLK, FDRK-WW 33.410 FDS, FDS-WW, FDLs, FDLs/M, FDLRS, FDRS-WW	301 kW		10/00→		5DR 009 728-441 Alternator Regulator	298
				09/02→; -05/04; ⚙️ D2866LF28; 90A	8EL 737 985-001 Alternator	296
				⚙️ D2866LF32; 90A	8EL 737 985-001 Alternator	296
				09/02→; -05/04; ⚙️ D2866LF32; 55A	8EL 738 055-001 Alternator	297
				09/02→; -05/04; ⚙️ D2866LF28; 55A	8EL 738 055-001 Alternator	297
				09/02→; -05/04; ⚙️ D2866LF28; 80A	8EL 738 211-021 Alternator	297
33.410 FD-TM, FDR-TM	301 kW		10/00→		5DR 009 728-441 Alternator Regulator	298
				09/02→; -05/04; ⚙️ D2866LF28; 90A	8EL 737 985-001 Alternator	296
				09/02→; -05/04; ⚙️ D2866LF28; 55A	8EL 738 055-001 Alternator	297
				09/02→; -05/04; ⚙️ D2866LF28; 80A	8EL 738 211-021 Alternator	297

Manufacturer - Model	Power	Displ.	Year of Constr.	Remark	Part Number	Page
MAN - TGA						04/00→
33.460 FDAC-WW	338 kW		09/02→	☺ D2876LF07; 90A	8EL 737 985-001 Alternator	296
33.460 FDAK-WW	338 kW		09/02→			
33.460 FDAS-WW	338 kW		09/02→	☺ D2876LF07; 55A	8EL 738 055-001 Alternator	297
40.460 FDAK-WW	338 kW		04/04→			
40.460 FDAS-WW	338 kW		04/04→	☺ D2876LF07; 80A	8EL 738 211-021 Alternator	297
33.460 FDC, FDC-WW, FDLK, FDLRC, FDRC-WW	338 kW		09/02→		5DR 009 728-441 Alternator Regulator	298
33.460 FDS, FDLS, FDLRS/M, FDLRS, FDRS-WW	338 kW		09/02→	01/06→; ☺ D2876LF07; 90A	8EL 737 985-001 Alternator	296
				09/02→; →12/05; ☺ D2876LF04; 90A	8EL 737 985-001 Alternator	296
				01/06→; ☺ D2876LF07; 55A	8EL 738 055-001 Alternator	297
				09/02→; →12/05; ☺ D2876LF04; 55A	8EL 738 055-001 Alternator	297
				01/06→; ☺ D2876LF07; 80A	8EL 738 211-021 Alternator	297
				09/02→; →12/05; ☺ D2876LF04; 80A	8EL 738 211-021 Alternator	297
33.460 FDK, FDK-WW, FDLK, FDRK-WW	338 kW		09/02→		5DR 009 728-441 Alternator Regulator	298
				01/06→; ☺ D2876LF07; 90A	8EL 737 985-001 Alternator	296
				09/02→; →05/04; ☺ D2876LF04; 90A	8EL 737 985-001 Alternator	296
				01/06→; ☺ D2876LF07; 55A	8EL 738 055-001 Alternator	297
				09/02→; →05/04; ☺ D2876LF04; 55A	8EL 738 055-001 Alternator	297
				01/06→; ☺ D2876LF07; 80A	8EL 738 211-021 Alternator	297
				09/02→; →05/04; ☺ D2876LF04; 80A	8EL 738 211-021 Alternator	297
33.460 FD-TM, FDR-TM	338 kW		09/02→		5DR 009 728-441 Alternator Regulator	298
				☺ D2876LF04; 90A	8EL 737 985-001 Alternator	296
				☺ D2876LF04; 55A	8EL 738 055-001 Alternator	297
33.480 FDAK, FDAK-WW, FDALK	353 kW		09/02→		5DR 009 728-441 Alternator Regulator	298
				10/02→; ☺ D2876LF12; 80A	8EL 738 211-021 Alternator	297
33.480 FDAS, FDAS-WW, FDARS, FDALS	353 kW		09/02→		5DR 009 728-441 Alternator Regulator	298
				08/03→; ☺ D2876LF12; 80A	8EL 738 211-021 Alternator	297
33.480 FDC, FDC-WW, FDLK, FDRC-WW, FDLRC	353 kW		09/02→		5DR 009 728-441 Alternator Regulator	298
				☺ D2876LF25; 80A	8EL 738 211-021 Alternator	297
				08/03→; →09/06; ☺ D2876LF12; 80A	8EL 738 211-021 Alternator	297
33.480 FDC, FDLK, FDRC, FDC/M	353 kW		01/06→	02/06→; ☺ D2876LF01; 80A	8EL 738 211-251 Alternator	297
33.480 FDK, FDLK, FDRK	353 kW		01/06→			
33.480 FDS, FDRS, FDLS, FDS/M	353 kW		01/06→	02/06→; ☺ D2876LF01; 110A	8EL 738 211-261 Alternator	298
33.480 FDK, FDK-WW, FDLK, FDRK-WW	353 kW		09/02→		5DR 009 728-441 Alternator Regulator	298
				08/03→; ☺ D2876LF12; 80A	8EL 738 211-021 Alternator	297
				☺ D2876LF25; 80A	8EL 738 211-021 Alternator	297
33.480 FDS, FDS-WW, FDLS, FDLS/M, FDRS-WW, FDLRS	353 kW		09/02→		5DR 009 728-441 Alternator Regulator	298
				06/03→; ☺ D2876LF12; 80A	8EL 738 211-021 Alternator	297
				☺ D2876LF25; 80A	8EL 738 211-021 Alternator	297
33.530 FDAK, FDALK	390 kW		09/02→	10/02→; ☺ D2876LF13; 80A	8EL 738 211-021 Alternator	297

Manufacturer - Model	Power	Displ.	Year of Constr.	Remark	Part Number	Page
MAN - TGA						04/00→
33.530 FDK, FDLK 33.530 FDS, FDLS, FDLS/M, FDRS, FDLRS	390 kW		07/03→	☺ D2876LF13; 90A	8EL 737 985-001 Alternator	296
	390 kW		07/03→	☺ D2876LF13; 55A	8EL 738 055-001 Alternator	297
35.310 FFDC, FFDLC 35.310 FFDK, FFDLK	228 kW		06/03→	06/03→; →06/05; ☺ D2866LF26; 90A	8EL 737 985-001 Alternator	296
	228 kW		06/03→	06/03→; →06/05; ☺ D2866LF26; 55A	8EL 738 055-001 Alternator	297
				06/03→; →06/05; ☺ D2866LF26; 80A	8EL 738 211-021 Alternator	297
35.350, 35.360 FFDC, FFDC, FFDLC	257 - 265 kW		02/04→	☺ D2066LF33; 80A	8EL 738 211-251 Alternator	297
				☺ D2066LF13; 80A	8EL 738 211-251 Alternator	297
				02/04→; →09/06; ☺ D2066LF03; 80A	8EL 738 211-251 Alternator	297
				10/04→; →09/06; ☺ D2066LF13; 80A	8EL 738 211-251 Alternator	297
				10/04→; →09/06; ☺ D2066LF13; 110A	8EL 738 211-261 Alternator	298
				02/04→; →09/06; ☺ D2066LF03; 110A	8EL 738 211-261 Alternator	298
				☺ D2066LF33; 110A	8EL 738 211-261 Alternator	298
				☺ D2066LF13; 110A	8EL 738 211-261 Alternator	298
				☺ D2066LF33; 120A	8EL 738 212-291 Alternator	298
				10/04→; →09/06; ☺ D2066LF13; 120A	8EL 738 212-291 Alternator	298
				02/04→; →09/06; ☺ D2066LF03; 120A	8EL 738 212-291 Alternator	298
				35.350, 35.360 FFDC, FFDRK, FFDLK 35.350, 35.360 FFD-TM	257 - 265 kW	
☺ D2066LF13; 80A	8EL 738 211-251 Alternator	297				
02/04→; →09/06; ☺ D2066LF03; 80A	8EL 738 211-251 Alternator	297				
10/04→; →09/06; ☺ D2066LF13; 80A	8EL 738 211-251 Alternator	297				
10/04→; →09/06; ☺ D2066LF13; 110A	8EL 738 211-261 Alternator	298				
02/04→; →09/06; ☺ D2066LF03; 110A	8EL 738 211-261 Alternator	298				
☺ D2066LF33; 110A	8EL 738 211-261 Alternator	298				
☺ D2066LF13; 110A	8EL 738 211-261 Alternator	298				
☺ D2066LF33; 120A	8EL 738 212-291 Alternator	298				
☺ D2066LF13; 120A	8EL 738 212-291 Alternator	298				
10/04→; →09/06; ☺ D2066LF13; 120A	8EL 738 212-291 Alternator	298				
02/04→; →09/06; ☺ D2066LF03; 120A	8EL 738 212-291 Alternator	298				
35.360 FFDC, FFDLK	265 kW		10/03→	10/03→; →12/05; ☺ D2866LF27; 90A	8EL 737 985-001 Alternator	296
				10/03→; →12/05; ☺ D2866LF27; 55A	8EL 738 055-001 Alternator	297
				10/03→; →12/05; ☺ D2866LF27; 80A	8EL 738 211-021 Alternator	297
35.390, 35.400 FFDC, FFDC, FFDLC	287 - 294 kW		02/04→	☺ D2066LF12; 80A	8EL 738 211-251 Alternator	297
				☺ D2066LF02; 80A	8EL 738 211-251 Alternator	297
				☺ D2066LF32; 80A	8EL 738 211-251 Alternator	297
				06/04→; →09/06; ☺ D2066LF02; 80A	8EL 738 211-251 Alternator	297
				10/04→; →09/06; ☺ D2066LF12; 80A	8EL 738 211-251 Alternator	297
				06/04→; →09/06; ☺ D2066LF02; 110A	8EL 738 211-261 Alternator	298

Manufacturer - Model	Power	Displ.	Year of Constr.	Remark	Part Number	Page
MAN - TGA						04/00→
35.390, 35.400 FFDK, FFDRC, FFDLC	287 - 294 kW		02/04→	10/04→; →09/06; ⚙️ D2066LF12; 110A	8EL 738 211-261 Alternator	298
				⚙️ D2066LF02; 110A	8EL 738 211-261 Alternator	298
				⚙️ D2066LF32; 110A	8EL 738 211-261 Alternator	298
				⚙️ D2066LF12; 110A	8EL 738 211-261 Alternator	298
				⚙️ D2066LF02; 120A	8EL 738 212-291 Alternator	298
				⚙️ D2066LF32; 120A	8EL 738 212-291 Alternator	298
				⚙️ D2066LF12; 120A	8EL 738 212-291 Alternator	298
				10/04→; →09/06; ⚙️ D2066LF12; 120A	8EL 738 212-291 Alternator	298
				06/04→; →09/06; ⚙️ D2066LF02; 120A	8EL 738 212-291 Alternator	298
35.390, 35.400 FFDK, FFDRC, FFDLK	287 - 294 kW		02/04→	⚙️ D2066LF12; 80A	8EL 738 211-251 Alternator	297
				⚙️ D2066LF02; 80A	8EL 738 211-251 Alternator	297
				⚙️ D2066LF32; 80A	8EL 738 211-251 Alternator	297
				08/04→; →09/06; ⚙️ D2066LF02; 80A	8EL 738 211-251 Alternator	297
				10/04→; →09/06; ⚙️ D2066LF12; 80A	8EL 738 211-251 Alternator	297
				08/04→; →09/06; ⚙️ D2066LF02; 110A	8EL 738 211-261 Alternator	298
				10/04→; →09/06; ⚙️ D2066LF12; 110A	8EL 738 211-261 Alternator	298
				⚙️ D2066LF02; 110A	8EL 738 211-261 Alternator	298
				⚙️ D2066LF32; 110A	8EL 738 211-261 Alternator	298
				⚙️ D2066LF12; 110A	8EL 738 211-261 Alternator	298
				⚙️ D2066LF02; 120A	8EL 738 212-291 Alternator	298
				⚙️ D2066LF32; 120A	8EL 738 212-291 Alternator	298
				⚙️ D2066LF12; 120A	8EL 738 212-291 Alternator	298
				10/04→; →09/06; ⚙️ D2066LF12; 120A	8EL 738 212-291 Alternator	298
				08/04→; →09/06; ⚙️ D2066LF02; 120A	8EL 738 212-291 Alternator	298
				35.390, 35.400 FFD-TM	287 - 294 kW	
⚙️ D2066LF02; 80A	8EL 738 211-251 Alternator	297				
⚙️ D2066LF32; 80A	8EL 738 211-251 Alternator	297				
07/04→; →09/06; ⚙️ D2066LF02; 80A	8EL 738 211-251 Alternator	297				
10/04→; →09/06; ⚙️ D2066LF12; 80A	8EL 738 211-251 Alternator	297				
07/04→; →09/06; ⚙️ D2066LF02; 110A	8EL 738 211-261 Alternator	298				
10/04→; →09/06; ⚙️ D2066LF12; 110A	8EL 738 211-261 Alternator	298				
⚙️ D2066LF02; 110A	8EL 738 211-261 Alternator	298				
⚙️ D2066LF32; 110A	8EL 738 211-261 Alternator	298				
⚙️ D2066LF12; 110A	8EL 738 211-261 Alternator	298				
⚙️ D2066LF02; 120A	8EL 738 212-291 Alternator	298				
⚙️ D2066LF32; 120A	8EL 738 212-291 Alternator	298				
⚙️ D2066LF12; 120A	8EL 738 212-291 Alternator	298				

Manufacturer - Model	Power	Displ.	Year of Constr.	Remark	Part Number	Page
MAN - TGA						04/00→
35.390, 35.400 FFD-TM	287 - 294 kW		02/04→	10/04→; -09/06; ☺ D2066LF12; 120A	8EL 738 212-291 Alternator	298
				07/04→; -09/06; ☺ D2066LF02; 120A	8EL 738 212-291 Alternator	298
35.410 FFDC, FFDLC 35.410 FFDK, FFDLK	301 kW		10/03→	10/03→; -05/04; ☺ D2866LF28; 90A	8EL 737 985-001 Alternator	296
	301 kW		10/03→	10/03→; -05/04; ☺ D2866LF28; 55A	8EL 738 055-001 Alternator	297
				10/03→; -05/04; ☺ D2866LF28; 80A	8EL 738 211-021 Alternator	297
35.430, 35.440 FFDC, FFDRC, FFDLC	316 - 324 kW		02/04→	☺ D2066LF11; 80A	8EL 738 211-251 Alternator	297
				☺ D2066LF01; 80A	8EL 738 211-251 Alternator	297
				☺ D2066LF31; 80A	8EL 738 211-251 Alternator	297
				03/04→; -09/06; ☺ D2066LF01; 80A	8EL 738 211-251 Alternator	297
				10/04→; -09/06; ☺ D2066LF11; 80A	8EL 738 211-251 Alternator	297
				03/04→; -09/06; ☺ D2066LF01; 110A	8EL 738 211-261 Alternator	298
				10/04→; -09/06; ☺ D2066LF11; 110A	8EL 738 211-261 Alternator	298
				☺ D2066LF01; 110A	8EL 738 211-261 Alternator	298
				☺ D2066LF31; 110A	8EL 738 211-261 Alternator	298
				☺ D2066LF11; 110A	8EL 738 211-261 Alternator	298
				☺ D2066LF11; 120A	8EL 738 212-291 Alternator	298
				☺ D2066LF31; 120A	8EL 738 212-291 Alternator	298
				☺ D2066LF01; 120A	8EL 738 212-291 Alternator	298
				10/04→; -09/06; ☺ D2066LF11; 120A	8EL 738 212-291 Alternator	298
				02/04→; -09/06; ☺ D2066LF01; 120A	8EL 738 212-291 Alternator	298
35.430, 35.440 FFDK, FFDRC, FFDLK 35.430, 35.440 FFD-TM	316 - 324 kW		02/04→	☺ D2066LF11; 80A	8EL 738 211-251 Alternator	297
	316 - 324 kW		02/04→	☺ D2066LF01; 80A	8EL 738 211-251 Alternator	297
				☺ D2066LF31; 80A	8EL 738 211-251 Alternator	297
				08/04→; -09/06; ☺ D2066LF01; 80A	8EL 738 211-251 Alternator	297
				10/04→; -09/06; ☺ D2066LF11; 80A	8EL 738 211-251 Alternator	297
				08/04→; -09/06; ☺ D2066LF01; 110A	8EL 738 211-261 Alternator	298
				10/04→; -09/06; ☺ D2066LF11; 110A	8EL 738 211-261 Alternator	298
				☺ D2066LF01; 110A	8EL 738 211-261 Alternator	298
				☺ D2066LF31; 110A	8EL 738 211-261 Alternator	298
				☺ D2066LF11; 110A	8EL 738 211-261 Alternator	298
				☺ D2066LF11; 120A	8EL 738 212-291 Alternator	298
				☺ D2066LF31; 120A	8EL 738 212-291 Alternator	298
				☺ D2066LF01; 120A	8EL 738 212-291 Alternator	298
				10/04→; -09/06; ☺ D2066LF11; 120A	8EL 738 212-291 Alternator	298
				08/04→; -09/06; ☺ D2066LF01; 120A	8EL 738 212-291 Alternator	298

Manufacturer - Model	Power	Displ.	Year of Constr.	Remark	Part Number	Page
MAN - TGA						04/00→
35.480 FFDC, FFDLC	353 kW		10/03→	10/03→; →09/06; ☺ D2876LF12: 90A	8EL 737 985-001 Alternator	296
35.480 FFDK, FFDLK	353 kW		10/03→	10/03→; →09/06; ☺ D2876LF12: 55A	8EL 738 055-001 Alternator	297
				10/03→; →09/06; ☺ D2876LF12: 80A	8EL 738 211-021 Alternator	297
35.480 FFDC, FFDLC	353 kW		02/04→	07/06→; ☺ D2676LF01: 80A	8EL 738 211-251 Alternator	297
35.480 FFDK, FFDLK	353 kW		02/04→			
35.480 FFD-TM	353 kW		02/04→	07/06→; ☺ D2676LF01: 110A	8EL 738 211-261 Alternator	298
37.480 FFDC	353 kW		02/06→			
37.480 FFDK	353 kW		02/06→			
35.530 FFDC, FFDLC	390 kW		04/04→	06/04→; →03/06; ☺ D2876LF13: 90A	8EL 737 985-001 Alternator	296
35.530 FFDK, FFDLK	390 kW		04/04→	06/04→; →03/06; ☺ D2876LF13: 55A	8EL 738 055-001 Alternator	297
				06/04→; →03/06; ☺ D2876LF13: 80A	8EL 738 211-021 Alternator	297
37.350, 37.360 FFDC	257 - 265 kW		12/04→	☺ D2066LF33: 80A	8EL 738 211-251 Alternator	297
37.350, 37.360 FFDK	257 - 265 kW		12/04→			
37.350, 37.360 FFD-TM	257 - 265 kW		12/04→	☺ D2066LF13: 80A	8EL 738 211-251 Alternator	297
41.350, 41.360 FFDC, FFDC/M, FFDRC	257 - 265 kW		12/04→			
41.350, 41.360 FFDK, FFDRC	257 - 265 kW		12/04→	12/04→; →09/06; ☺ D2066LF13: 80A	8EL 738 211-251 Alternator	297
				12/04→; →09/06; ☺ D2066LF03: 80A	8EL 738 211-251 Alternator	297
				12/04→; →09/06; ☺ D2066LF13: 110A	8EL 738 211-261 Alternator	298
				☺ D2066LF13: 110A	8EL 738 211-261 Alternator	298
				12/04→; →09/06; ☺ D2066LF03: 110A	8EL 738 211-261 Alternator	298
				☺ D2066LF33: 110A	8EL 738 211-261 Alternator	298
				☺ D2066LF33: 120A	8EL 738 212-291 Alternator	298
				☺ D2066LF13: 120A	8EL 738 212-291 Alternator	298
				12/04→; →09/06; ☺ D2066LF13: 120A	8EL 738 212-291 Alternator	298
				12/04→; →09/06; ☺ D2066LF03: 120A	8EL 738 212-291 Alternator	298
37.390, 37.400 FFDC	287 - 294 kW		12/04→	☺ D2066LF12: 80A	8EL 738 211-251 Alternator	297
37.390, 37.400 FFDK	287 - 294 kW		12/04→			
37.390, 37.400 FFD-TM	287 - 294 kW		12/04→	☺ D2066LF02: 80A	8EL 738 211-251 Alternator	297
41.390, 41.400 FFDC, FFDC/M, FFDRC	287 - 294 kW		12/04→			
41.390, 41.400 FFDK, FFDRC	287 - 294 kW		12/04→	☺ D2066LF32: 80A	8EL 738 211-251 Alternator	297
41.390, 41.400 FFD-TM	287 - 294 kW		12/04→			
				12/04→; →09/06; ☺ D2066LF12: 80A	8EL 738 211-251 Alternator	297
				12/04→; →09/06; ☺ D2066LF02: 80A	8EL 738 211-251 Alternator	297
				12/04→; →09/06; ☺ D2066LF02: 110A	8EL 738 211-261 Alternator	298
				12/04→; →09/06; ☺ D2066LF12: 110A	8EL 738 211-261 Alternator	298
				☺ D2066LF12: 110A	8EL 738 211-261 Alternator	298
				☺ D2066LF32: 110A	8EL 738 211-261 Alternator	298
				☺ D2066LF02: 110A	8EL 738 211-261 Alternator	298
				☺ D2066LF02: 120A	8EL 738 212-291 Alternator	298
				☺ D2066LF32: 120A	8EL 738 212-291 Alternator	298
				☺ D2066LF12: 120A	8EL 738 212-291 Alternator	298
				12/04→; →09/06; ☺ D2066LF12: 120A	8EL 738 212-291 Alternator	298
				12/04→; →09/06; ☺ D2066LF02: 120A	8EL 738 212-291 Alternator	298
37.430, 37.440 FFDC	316 - 324 kW		12/04→	☺ D2066LF11: 80A	8EL 738 211-251 Alternator	297
37.430, 37.440 FFDK	316 - 324 kW		12/04→			
37.430, 37.440 FFD-TM	316 - 324 kW		12/04→			

Manufacturer - Model	Power	Displ.	Year of Constr.	Remark	Part Number	Page
MAN - TGA						04/00→
41.430, 41.440 FFDK, FFDRK	316 - 324 kW		12/04→	☺ D2066LF01; 80A	8EL 738 211-251 Alternator	297
				☺ D2066LF31; 80A	8EL 738 211-251 Alternator	297
				12/04→; →09/06; ☺ D2066LF11; 80A	8EL 738 211-251 Alternator	297
				12/04→; →09/06; ☺ D2066LF01; 80A	8EL 738 211-251 Alternator	297
				12/04→; →09/06; ☺ D2066LF01; 110A	8EL 738 211-261 Alternator	298
				12/04→; →09/06; ☺ D2066LF11; 110A	8EL 738 211-261 Alternator	298
				☺ D2066LF11; 110A	8EL 738 211-261 Alternator	298
				☺ D2066LF31; 110A	8EL 738 211-261 Alternator	298
				☺ D2066LF01; 110A	8EL 738 211-261 Alternator	298
				☺ D2066LF11; 120A	8EL 738 212-291 Alternator	298
				☺ D2066LF31; 120A	8EL 738 212-291 Alternator	298
				☺ D2066LF01; 120A	8EL 738 212-291 Alternator	298
				12/04→; →09/06; ☺ D2066LF11; 120A	8EL 738 212-291 Alternator	298
				12/04→; →09/06; ☺ D2066LF01; 120A	8EL 738 212-291 Alternator	298
37.480 FFD-TM	353 kW		02/06→	07/06→; ☺ D2676LF01; 80A	8EL 738 211-251 Alternator	297
				07/06→; ☺ D2676LF01; 110A	8EL 738 211-261 Alternator	298
				☺ D2676LF01; 120A	8EL 738 212-291 Alternator	298
39.390 FVNLC	287 kW		07/06→	☺ D2066LF12; 120A	8EL 738 212-291 Alternator	298
40.390, 40.400 FDAK-WW 40.390, 40.400 FDAS-WW	287 - 294 kW 287 - 294 kW		06/05→ 06/05→	☺ D2066LF02; 80A	8EL 738 211-251 Alternator	297
				☺ D2066LF06; 80A	8EL 738 211-251 Alternator	297
				☺ D2066LF37; 80A	8EL 738 211-251 Alternator	297
				☺ D2066LF06; 110A	8EL 738 211-261 Alternator	298
				☺ D2066LF37; 110A	8EL 738 211-261 Alternator	298
				☺ D2066LF02; 110A	8EL 738 211-261 Alternator	298
				☺ D2066LF37; 120A	8EL 738 212-291 Alternator	298
				☺ D2066LF06; 120A	8EL 738 212-291 Alternator	298
40.390, 40.400 FDK-WW, FDRK 40.390, 40.400 FDS-WW, FDRS	287 - 294 kW 287 - 294 kW		06/05→ 06/05→	☺ D2066LF02; 80A	8EL 738 211-251 Alternator	297
				06/05→; →09/06; ☺ D2066LF02; 80A	8EL 738 211-251 Alternator	297
				06/05→; →09/06; ☺ D2066LF02; 110A	8EL 738 211-261 Alternator	298
				☺ D2066LF02; 110A	8EL 738 211-261 Alternator	298
				06/05→; →09/06; ☺ D2066LF02; 120A	8EL 738 212-291 Alternator	298

Manufacturer - Model	Power	Displ.	Year of Constr.	Remark	Part Number	Page
MAN - TGA						04/00→
40.410 FDAK-WW 40.410 FDAS-WW	301 kW 301 kW		04/04→ 04/04→	☺ D2866LF28; 90A	8EL 737 985-001 Alternator	296
				☺ D2866LF32; 90A	8EL 737 985-001 Alternator	296
				☺ D2866LF28; 55A	8EL 738 055-001 Alternator	297
				☺ D2866LF32; 55A	8EL 738 055-001 Alternator	297
				☺ D2866LF28; 80A	8EL 738 211-021 Alternator	297
				☺ D2866LF32; 80A	8EL 738 211-021 Alternator	297
40.410 FDK-WW 40.410 FDS-WW	301 kW 301 kW		04/04→ 04/04→	04/04→; -12/05; ☺ D2866LF32; 90A	8EL 737 985-001 Alternator	296
				04/04→; -12/05; ☺ D2866LF28; 90A	8EL 737 985-001 Alternator	296
				04/04→; -12/05; ☺ D2866LF32; 55A	8EL 738 055-001 Alternator	297
				04/04→; -12/05; ☺ D2866LF28; 55A	8EL 738 055-001 Alternator	297
				04/04→; -12/05; ☺ D2866LF28; 80A	8EL 738 211-021 Alternator	297
				04/04→; -12/05; ☺ D2866LF32; 80A	8EL 738 211-021 Alternator	297
40.430, 40.440 FDAK-WW 40.430, 40.440 FDAS-WW	316 - 324 kW 316 - 324 kW		06/05→ 06/05→	☺ D2066LF01; 80A	8EL 738 211-251 Alternator	297
				☺ D2066LF36; 80A	8EL 738 211-251 Alternator	297
				☺ D2066LF01; 110A	8EL 738 211-261 Alternator	298
				☺ D2066LF36; 110A	8EL 738 211-261 Alternator	298
				☺ D2066LF36; 120A	8EL 738 212-291 Alternator	298
				☺ D2066LF01; 120A	8EL 738 212-291 Alternator	298
40.430 FDK-WW, FDRK 40.430 FDS-WW, FDRS	316 kW 316 kW		06/05→ 06/05→	06/05→; -09/06; ☺ D2066LF01; 80A	8EL 738 211-251 Alternator	297
				06/05→; -09/06; ☺ D2066LF01; 110A	8EL 738 211-261 Alternator	298
				06/05→; -09/06; ☺ D2066LF01; 120A	8EL 738 212-291 Alternator	298
40.460 FDK-WW 40.460 FDS-WW	338 kW 338 kW		04/04→ 04/04→	01/06→; ☺ D2876LF07; 90A	8EL 737 985-001 Alternator	296
				01/06→; ☺ D2876LF07; 55A	8EL 738 055-001 Alternator	297
				01/06→; ☺ D2876LF07; 80A	8EL 738 211-021 Alternator	297
40.480 FDAK-WW 40.480 FDAS-WW	353 kW 353 kW		04/04→ 04/04→	☺ D2876LF25; 80A	8EL 738 211-021 Alternator	297
				☺ D2876LF12; 80A	8EL 738 211-021 Alternator	297
40.480 FDAK-WW 40.480 FDAS-WW	353 kW 353 kW		06/05→ 06/05→	☺ D2676LF02; 80A	8EL 738 211-251 Alternator	297
				☺ D2676LF03; 80A	8EL 738 211-251 Alternator	297
				☺ D2676LF02; 110A	8EL 738 211-261 Alternator	298
				☺ D2676LF03; 110A	8EL 738 211-261 Alternator	298
				☺ D2676LF03; 120A	8EL 738 212-291 Alternator	298
				☺ D2676LF02; 120A	8EL 738 212-291 Alternator	298
40.480 FDK-WW 40.480 FDS-WW	353 kW 353 kW		04/04→ 04/04→	11/04→; -09/06; ☺ D2876LF12; 80A	8EL 738 211-021 Alternator	297
				11/04→; -09/06; ☺ D2876LF25; 80A	8EL 738 211-021 Alternator	297
40.480 FDS-WW; FDRS	353 kW		06/05→	☺ D2676LF03; 120A	8EL 738 212-291 Alternator	298
				☺ D2676LF02; 120A	8EL 738 212-291 Alternator	298
				☺ D2676LF12; 120A	8EL 738 212-291 Alternator	298

Manufacturer - Model	Power	Displ.	Year of Constr.	Remark	Part Number	Page
MAN - TGA						04/00→
41.350, 41.360 FFD-TM	257 - 265 kW		12/04→	☺ D2066LF13; 80A	8EL 738 211-251 Alternator	297
				☺ D2066LF33; 80A	8EL 738 211-251 Alternator	297
				12/04→; →09/06; ☺ D2066LF13; 80A	8EL 738 211-251 Alternator	297
				12/04→; →09/06; ☺ D2066LF03; 80A	8EL 738 211-251 Alternator	297
				12/04→; →09/06; ☺ D2066LF13; 110A	8EL 738 211-261 Alternator	298
				12/04→; →09/06; ☺ D2066LF03; 110A	8EL 738 211-261 Alternator	298
				☺ D2066LF33; 110A	8EL 738 211-261 Alternator	298
				☺ D2066LF13; 110A	8EL 738 211-261 Alternator	298
				☺ D2066LF33; 120A	8EL 738 212-291 Alternator	298
				☺ D2066LF13; 120A	8EL 738 212-291 Alternator	298
				☺ D2066LF03; 120A	8EL 738 212-291 Alternator	298
				12/04→; →09/06; ☺ D2066LF13; 120A	8EL 738 212-291 Alternator	298
				12/04→; →09/06; ☺ D2066LF03; 120A	8EL 738 212-291 Alternator	298
41.350 FFDC-TM, FFDC-TM	257 kW		09/07→	☺ D2066LF03; 110A	8EL 738 211-261 Alternator	298
41.360 FFDC, FFDC/M, FFDC/M-WW, FFDC	265 kW		01/03→		5DR 009 728-441 Alternator Regulator	298
				01/03→; →12/05; ☺ D2866LF37; 90A	8EL 737 985-001 Alternator	296
				01/03→; →12/05; ☺ D2866LF27; 90A	8EL 737 985-001 Alternator	296
				01/03→; →12/05; ☺ D2866LF37; 55A	8EL 738 055-001 Alternator	297
				01/03→; →12/05; ☺ D2866LF27; 55A	8EL 738 055-001 Alternator	297
41.360 FFDC-TM, FDRC-TM	265 kW		09/07→	☺ D2066LF07; 80A	8EL 738 211-251 Alternator	297
41.360 FFD-TM	265 kW		12/04→	☺ D2866LF27; 120A	8EL 738 212-291 Alternator	298
41.390 FFDC-TM, FDRC-TM	287 kW		09/07→	☺ D2066LF02; 110A	8EL 738 211-261 Alternator	298
41.400 FFD	294 kW		12/08→	☺ D2066LF06; 110A	8EL 738 211-261 Alternator	298
41.400 FFDC-TM, FDRC-TM	294 kW		09/07→			
41.410 FFDC-WW, FDRC 41.410 FFDK-WW	301 kW 301 kW		09/03→ 09/03→	☺ D2866LF32; 90A	8EL 737 985-001 Alternator	296
				☺ D2866LF28; 90A	8EL 737 985-001 Alternator	296
				☺ D2866LF28; 55A	8EL 738 055-001 Alternator	297
				☺ D2866LF32; 55A	8EL 738 055-001 Alternator	297
41.430, 41.440 FFDC, FFDC, FFDC/M	316 - 324 kW		12/04→	☺ D2066LF11; 80A	8EL 738 211-251 Alternator	297
				☺ D2066LF01; 80A	8EL 738 211-251 Alternator	297
				07/06→; ☺ D2066LF31; 80A	8EL 738 211-251 Alternator	297
				12/04→; →09/06; ☺ D2066LF11; 80A	8EL 738 211-251 Alternator	297
				12/04→; →09/06; ☺ D2066LF01; 80A	8EL 738 211-251 Alternator	297
				12/04→; →09/06; ☺ D2066LF01; 110A	8EL 738 211-261 Alternator	298
				12/04→; →09/06; ☺ D2066LF11; 110A	8EL 738 211-261 Alternator	298
				☺ D2066LF11; 110A	8EL 738 211-261 Alternator	298
				☺ D2066LF31; 110A	8EL 738 211-261 Alternator	298
				☺ D2066LF01; 110A	8EL 738 211-261 Alternator	298

Manufacturer - Model	Power	Displ.	Year of Constr.	Remark	Part Number	Page
MAN - TGA						04/00→
41.430, 41.440 FFDC, FFDC/M	316 - 324 kW		12/04→	☺ D2066LF11; 120A	8EL 738 212-291 Alternator	298
				☺ D2066LF31; 120A	8EL 738 212-291 Alternator	298
				☺ D2066LF01; 120A	8EL 738 212-291 Alternator	298
				12/04→; →09/06; ☺ D2066LF11; 120A	8EL 738 212-291 Alternator	298
				12/04→; →09/06; ☺ D2066LF01; 120A	8EL 738 212-291 Alternator	298
41.430, 41.440 FFD-TM	316 - 324 kW		12/04→	☺ D2066LF11; 80A	8EL 738 211-251 Alternator	297
				☺ D2066LF01; 80A	8EL 738 211-251 Alternator	297
				☺ D2066LF31; 80A	8EL 738 211-251 Alternator	297
				12/04→; →09/06; ☺ D2066LF11; 80A	8EL 738 211-251 Alternator	297
				12/04→; →09/06; ☺ D2066LF01; 80A	8EL 738 211-251 Alternator	297
				12/04→; →09/06; ☺ D2066LF01; 110A	8EL 738 211-261 Alternator	298
				12/04→; →09/06; ☺ D2066LF11; 110A	8EL 738 211-261 Alternator	298
				☺ D2066LF11; 110A	8EL 738 211-261 Alternator	298
				☺ D2066LF31; 110A	8EL 738 211-261 Alternator	298
				☺ D2066LF01; 110A	8EL 738 211-261 Alternator	298
				☺ D2066LF11; 120A	8EL 738 212-291 Alternator	298
				☺ D2066LF31; 120A	8EL 738 212-291 Alternator	298
				12/04→; →09/06; ☺ D2066LF01; 120A	8EL 738 212-291 Alternator	298
				☺ D2066LF01; 120A	8EL 738 212-291 Alternator	298
41.430 FFDAK	316 kW		07/06→	☺ D2066LF11; 120A	8EL 738 212-291 Alternator	298
41.430 FFDC-TM, FFDC	316 kW		09/07→	☺ D2066LF01; 80A	8EL 738 211-251 Alternator	297
41.480 FFD	353 kW		12/08→	☺ D2676LF03; 120A	8EL 738 212-291 Alternator	298
41.480 FFDAK	353 kW		07/06→	☺ D2876LF12; 80A	8EL 738 211-021 Alternator	297
				☺ D2676LF05; 80A	8EL 738 211-251 Alternator	297
				☺ D2676LF02; 120A	8EL 738 212-291 Alternator	298
				☺ D2676LF05; 120A	8EL 738 212-291 Alternator	298
41.530 FVDS, FVDLS	390 kW		09/02→		5DR 009 728-441 Alternator Regulator	298
				06/03→; ☺ D2876LF13; 80A	8EL 738 211-021 Alternator	297
41.540 FVDS, FVDLS	397 kW		11/06→	☺ D2676LF13; 120A	8EL 738 212-291 Alternator	298
41.660 FVDS, FVDLS	485 kW		09/02→	04/03→; ☺ D2840LF25; 110A	8EL 738 211-261 Alternator	298
MAN - TGL						04/05→
10.180 FC, FRC, FLC, FLRC 12.180 FC, FRC, FLC, FLRC 7.180 FC, FLC, FRC, FLRC	132 kW		04/05→ 04/05→ 04/05→	☺ D0834LFL41; 80A	8EL 738 211-251 Alternator	297
				☺ D0834LFL51; 80A	8EL 738 211-251 Alternator	297
				☺ D0834LFL51; 110A	8EL 738 211-261 Alternator	298
				☺ D0834LFL41; 110A	8EL 738 211-261 Alternator	298
10.180 FK, FRK 12.180 FK, FRK	132 kW		04/05→ 04/05→	☺ D0834LFL41; 80A	8EL 738 211-251 Alternator	297
				☺ D0834LFL41; 110A	8EL 738 211-261 Alternator	298

Manufacturer - Model	Power	Displ.	Year of Constr.	Remark	Part Number	Page
MAN - TGL						04/05→
10.210 FC, FRC, FLC, FLRC	151 kW		04/05→	☞ D0834LFL42; 80A	8EL 738 211-251 Alternator	297
10.210 FK, FRK	151 kW		04/05→			
12.210 FC, FRC, FLC, FLRC	151 kW		04/05→	☞ D0834LFL42; 110A	8EL 738 211-261 Alternator	298
12.210 FK, FRK	151 kW		04/05→			
8.210 FC, FRC, FLC, FLRC	151 kW		04/05→			
8.210 FK, FK-L, FRK, FRK-L	151 kW		04/05→			
10.220 FC, FLC, FRC, FLRC	162 kW		04/05→	☞ D0834LFL65; 110A	8EL 738 211-261 Alternator	298
12.220 FC, FRC, FLC, FLRC	162 kW		04/05→			
12.220 FK, FRK	162 kW		04/05→			
8.220 FK, FRK, FK-L, FRK-L	162 kW		04/05→			
10.220 FK, FRK	162 kW		04/05→	☞ D0834LFL65; 80A	8EL 738 211-251 Alternator	297
8.220 FC, FLC, FRC, FLRC	162 kW		04/05→			
10.240 FC, FRC, FLC, FLRC	176 kW		04/05→	☞ D0836LFL40; 80A	8EL 738 211-251 Alternator	297
10.240 FK, FRK	176 kW		04/05→			
12.240 FC, FRC, FLC, FLRC	176 kW		04/05→	☞ D0836LFL40; 110A	8EL 738 211-261 Alternator	298
12.240 FK, FRK	176 kW		04/05→			
8.240 FC, FRC, FLC, FLRC	176 kW		04/05→			
8.240 FK, FK-L, FRK, FRK-L	176 kW		04/05→			
10.250 FC, FLC, FRC, FLRC	184 kW		04/05→	☞ D0836LFL63; 80A	8EL 738 211-251 Alternator	297
8.250 FK, FK-L, FRK, FRK-L	184 kW		04/05→			
10.250 FK, FRK	184 kW		04/05→	☞ D0836LFL63; 110A	8EL 738 211-261 Alternator	298
12.250 FC, FLC, FRC, FLRC	184 kW		04/05→			
12.250 FK, FRK	184 kW		04/05→			
8.250 FC, FLC, FLRC, FRC	184 kW		04/05→			
7.150, 8.150 FC, FRC, FLC, FLRC	110 kW		04/05→	☞ D0834LFL40; 80A	8EL 738 211-251 Alternator	297
8.150 FK, FRK, FK-L, FRK-L	110 kW		10/06→	☞ D0834LFL50; 80A	8EL 738 211-251 Alternator	297
				☞ D0834LFL40; 110A	8EL 738 211-261 Alternator	298
				☞ D0834LFL50; 110A	8EL 738 211-261 Alternator	298
7.220 FC, FLC, FRC, FLRC	162 kW		04/05→	☞ D0834LFL65; 80A	8EL 738 211-251 Alternator	297
				☞ D0834LFL62; 80A	8EL 738 211-251 Alternator	297
				☞ D0834LFL62; 110A	8EL 738 211-261 Alternator	298
				☞ D0834LFL65; 110A	8EL 738 211-261 Alternator	298
8.180 FC, FRC, FLC, FLRC	132 kW		04/05→	04/05→; →09/06; ☞ D0834LFL41; 80A	8EL 738 211-251 Alternator	297
8.180 FK, FK-L, FRK, FRK-L	132 kW		04/05→	04/05→; →09/06; ☞ D0834LFL51; 80A	8EL 738 211-251 Alternator	297
				04/05→; →09/06; ☞ D0834LFL51; 110A	8EL 738 211-261 Alternator	298
				04/05→; →09/06; ☞ D0834LFL41; 110A	8EL 738 211-261 Alternator	298
MAN - TGM						10/05→
12.240 FLC, FLLC	176 kW		10/05→	12/05→; ☞ D0836LFL50; 80A	8EL 738 211-251 Alternator	297
				12/05→; ☞ D0836LFL50; 110A	8EL 738 211-261 Alternator	298
12.250 FLC, FLLC	184 kW		10/05→	☞ D0836LFL63; 80A	8EL 738 211-251 Alternator	297
13.250 FAEC, FAERC, FALC, FAL, FALRC, FALR	184 kW		10/05→			
22.250 FNLLC	184 kW		10/05→			
12.280 FC, FLC, FLLC	206 kW		10/05→	12/05→; ☞ D0836LFL51; 80A	8EL 738 211-251 Alternator	297
				12/05→; ☞ D0836LFL51; 110A	8EL 738 211-261 Alternator	298
12.290 FLC, FLLC	213 kW		10/05→	☞ D0836LFL64; 80A	8EL 738 211-251 Alternator	297
15.290 FLK, FLRK	213 kW		10/05→			
18.290 FAK, FARK, FAK-L, FARK-L	213 kW		10/05→			
18.290 FC, FLC, FRC, FLRC, FLLC, FLLRC	213 kW		10/05→			
18.290 FK, FLK, FRK, FLRK	213 kW		10/05→			
22.290 FNL, 22.290 FNLLC	213 kW		10/05→			
26.290 FD, FDR	213 kW		10/05→			
26.290 FDK-HK, FDRK-HK	213 kW		10/05→			
26.290 FD-TM, FDR-TM	213 kW		07/08→			
26.290 FNLC, FNLLC, FNLRC, FNLLRC, FVL	213 kW		10/05→			

Manufacturer - Model	Power	Displ.	Year of Constr.	Remark	Part Number	Page
MAN - TGM						10/05→
13.240 FAL, FALC, FALRC, FAEC, FAERC, FALR	176 kW		04/06→	05/06→; ☉ D0836LFL50; 80A	8EL 738 211-251 Alternator	297
13.240 FALK, FALRK, FALK-L, FALRK-L	176 kW		04/06→	05/06→; ☉ D0836LFL40; 80A	8EL 738 211-251 Alternator	297
				05/06→; ☉ D0836LFL50; 110A	8EL 738 211-261 Alternator	298
				05/06→; ☉ D0836LFL40; 110A	8EL 738 211-261 Alternator	298
13.250 FALK, FALRK, FALK-L, FALRK-L	184 kW		10/05→	☉ D0836LFL63; 110A	8EL 738 211-261 Alternator	298
15.250 FC, FLC, FLRC, FLLC, FLLRC	184 kW		10/05→			
15.250 FLK, FLRK	184 kW		10/05→			
18.250 FAC, FARC	184 kW		10/05→			
18.250 FAK, FARK, FAK-L, FARK-L	184 kW		10/05→			
18.250 FC, FLC, FLLC, FRC, FLRC, FLLRC	184 kW		10/05→			
18.250 FK, FLK, FRK, FLRK	184 kW		10/05→			
13.280 FAEC, FAERC, FAL, FALC, FALRC	206 kW		04/06→	05/06→; ☉ D0836LFL51; 80A	8EL 738 211-251 Alternator	297
13.280 FALK, FALRK, FALK-L, FALRK-L	206 kW		04/06→	05/06→; ☉ D0836LFL41; 80A	8EL 738 211-251 Alternator	297
				05/06→; ☉ D0836LFL51; 110A	8EL 738 211-261 Alternator	298
				05/06→; ☉ D0836LFL41; 110A	8EL 738 211-261 Alternator	298
13.290 FAEC, FAERC, FAL, FALR, FALC, FALRC	213 kW		10/05→	☉ D0836LFL64; 110A	8EL 738 211-261 Alternator	298
13.290 FALK, FALRK, FALK-L, FALRK-L	213 kW		10/05→			
15.290 FC, FLC, FLRC, FLLC, FLLRC	213 kW		10/05→			
18.290 FAC, FARC	213 kW		10/05→			
15.240 FC, FLC, FLLC, FLRC, FLLRC	176 kW		10/05→	☉ D0836LFL50; 80A	8EL 738 211-251 Alternator	297
				☉ D0836LFL50; 110A	8EL 738 211-261 Alternator	298
15.240 FLK, FLRK	176 kW		10/05→	☉ D0836LFL40; 110A	8EL 738 211-261 Alternator	298
18.240 FAK, FARK, FAK-L, FARK-L	176 kW		05/06→	☉ D0836LFL53; 110A	8EL 738 211-261 Alternator	298
15.280 FC, FLC, FLLC, FLRC, FLLRC	206 kW		10/05→	☉ D0836LFL51; 80A	8EL 738 211-251 Alternator	297
26.280 FDK-HK, FDRK-HK	206 kW		04/06→	☉ D0836LFL51; 110A	8EL 738 211-261 Alternator	298
26.280 FD-TM, FDR-TM	206 kW		04/06→			
15.280 FLK, FLRK	206 kW		10/05→	☉ D0836LFL41; 110A	8EL 738 211-261 Alternator	298
				☉ D0836LFL54; 110A	8EL 738 211-261 Alternator	298
15.330 FC, FLC, FRC, FLRC	240 kW		10/05→	☉ D0836LFL55; 80A	8EL 738 211-251 Alternator	297
15.330 FLK, FLRK	240 kW		10/05→			
18.330 FAK, FARK, FAK-L, FARK, L	240 kW		10/05→	☉ D0836LFL44; 80A	8EL 738 211-251 Alternator	297
15.340 FC, FLC, FLRC	250 kW		10/05→	☉ D0836LFL65; 110A	8EL 738 211-261 Alternator	298
18.340 FAC, FARC	250 kW		10/05→			
18.340 FAK, FARK, FAK-L, FARK-L	250 kW		10/05→			
18.340 FC, FLC, FLRC, FLLC, FLLRC, FRC	250 kW		10/05→			
26.340 FDK-HK, FDRK-HK	250 kW		10/05→			
15.340 FLK, FLRK	250 kW		10/05→	☉ D0836LFL65; 80A	8EL 738 211-251 Alternator	297
18.340 FK, FRK, FLK, FLRK	250 kW		10/05→			
26.340 FD, FDR	250 kW		10/05→			
26.340 FD-TM, FDR-TM	250 kW		07/08→			
26.340 FNLC, FNLLC, FNLR, FNLLRC	250 kW		10/05→			
18.240 FAC, FARC	176 kW		10/05→	☉ D0836LFL40; 80A	8EL 738 211-251 Alternator	297
18.240 FC, FRC, FLC, FLRC, FLLC, FLLRC	176 kW		10/05→	☉ D0836LFL40; 110A	8EL 738 211-261 Alternator	298
18.240 FK, FRK, FLK, FK-L, FLRK	176 kW		10/05→			

Manufacturer - Model	Power	Displ.	Year of Constr.	Remark	Part Number	Page
MAN - TGM						10/05→
18.280 FAC, FARC	206 kW		10/05→	☞ D0836LFL51; 80A	8EL 738 211-251 Alternator	297
				☞ D0836LFL41; 80A	8EL 738 211-251 Alternator	297
				☞ D0836LFL51; 110A	8EL 738 211-261 Alternator	298
				☞ D0836LFL41; 110A	8EL 738 211-261 Alternator	298
18.280 FAK, FARK, FAK-L, FARK-L	206 kW		10/05→	☞ D0836LFL54; 80A	8EL 738 211-251 Alternator	297
				☞ D0836LFL41; 80A	8EL 738 211-251 Alternator	297
18.280 FC, FRC, FLC, FLRC, FLLC, FLLRC	206 kW		10/05→	☞ D0836LFL41; 80A	8EL 738 211-251 Alternator	297
18.280 FK, FLK, FRK, FLRK, FK-L	206 kW		10/05→	☞ D0836LFL41; 110A	8EL 738 211-261 Alternator	298
18.330 FAC, FARC	240 kW		10/05→	☞ D0836LFL52; 80A	8EL 738 211-251 Alternator	297
				☞ D0836LFL44; 80A	8EL 738 211-251 Alternator	297
				☞ D0836LFL52; 110A	8EL 738 211-261 Alternator	298
				☞ D0836LFL44; 110A	8EL 738 211-261 Alternator	298
18.330 FC, FRC, FLC, FLRC, FLLC, FLLRC	240 kW		10/05→	☞ D0836LFL44; 80A	8EL 738 211-251 Alternator	297
18.330 FK, FLK, FRK, FLRK, FK-L	240 kW		10/05→	☞ D0836LFL44; 110A	8EL 738 211-261 Alternator	298
22.240 FNLLC	176 kW		10/05→	☞ D0836LFL53; 80A	8EL 738 211-251 Alternator	297
22.280 FNL, 22.280 FNLLC	206 kW		10/05→	☞ D0836LFL54; 80A	8EL 738 211-251 Alternator	297
26.280 FD	206 kW		10/05→	☞ D0836LFL54; 110A	8EL 738 211-261 Alternator	298
26.280 FNLC, FNLLC, FNLRC, FNLLRC	206 kW		10/05→			
26.330 FD, FDR	240 kW		10/05→	☞ D0836LFL55; 80A	8EL 738 211-251 Alternator	297
26.330 FDK-HK, FDRK-HK 26.330 FD-TM, FDR-TM	240 kW 240 kW		04/06→	☞ D0836LFL52; 80A	8EL 738 211-251 Alternator	297
			04/06→	☞ D0836LFL52; 110A	8EL 738 211-261 Alternator	298
26.330 FNLC, FNLLC, FNLRC, FNLLRC, FVL	240 kW		10/05→	☞ D0836LFL55; 110A	8EL 738 211-261 Alternator	298
MAN - TGS						09/07→
18.320 FAC, FHLC	235 kW		10/07→	☞ D2066LF39; 80A	8EL 738 211-251 Alternator	297
				☞ D2066LF39; 110A	8EL 738 211-261 Alternator	298
				☞ D2066LF39; 120A	8EL 738 212-291 Alternator	298
18.320 FAK, FAK-L, FALK, FALK-L, FHLK, FHLK/M	235 kW		10/07→	☞ D2066LF28; 80A	8EL 738 211-251 Alternator	297
				☞ D2066LF39; 80A	8EL 738 211-251 Alternator	297
				☞ D2066LF28; 110A	8EL 738 211-261 Alternator	298
				☞ D2066LF39; 110A	8EL 738 211-261 Alternator	298
				☞ D2066LF39; 120A	8EL 738 212-291 Alternator	298
18.320 FAS, FHLS, FHLS/M 18.320 FC, FLC, FLRC, FLLC, FLLRC, FLLW, FLLW/N	235 kW 235 kW		10/07→ 10/07→	☞ D2066LF28; 80A	8EL 738 211-251 Alternator	297
				☞ D2066LF39; 80A	8EL 738 211-251 Alternator	297
				☞ D2066LF39; 110A	8EL 738 211-261 Alternator	298
				☞ D2066LF28; 110A	8EL 738 211-261 Alternator	298
18.320 FK, FK-L, FLK, FLK/M 18.320 FLS, FLS/M, FLS-TS, FLRS, FLRS/M, FLLS, FLLS/N, FLLRS	235 kW 235 kW		10/07→ 10/07→	☞ D2066LF39; 80A	8EL 738 211-251 Alternator	297
				☞ D2066LF39; 110A	8EL 738 211-261 Alternator	298

Manufacturer - Model	Power	Displ.	Year of Constr.	Remark	Part Number	Page
MAN - TGS						09/07→
18.360 FAC, FHLC	265 kW		10/07→	☪ D2066LF38; 80A	8EL 738 211-251 Alternator	297
				☪ D2066LF27; 80A	8EL 738 211-251 Alternator	297
				☪ D2066LF27; 110A	8EL 738 211-261 Alternator	298
18.360 FAK, FAK-L, FALK, FALK-L, FHLK, FHLK/M 18.360 FAS, FALS, FHLS, FHLS/M 18.360 FC, FLC, FLRC, FLLC, FLLRC, FLLW, FLLW/N 24.360 FNLLW/N 24.360 FPLS, FPLRS	265 kW		10/07→	☪ D2066LF27; 80A	8EL 738 211-251 Alternator	297
	265 kW		10/07→	☪ D2066LF38; 80A	8EL 738 211-251 Alternator	297
	265 kW		10/07→	☪ D2066LF38; 110A	8EL 738 211-261 Alternator	298
	265 kW		10/07→	☪ D2066LF27; 110A	8EL 738 211-261 Alternator	298
18.360 FK, FK-L, FLK, FLK/M 18.360 FLS, FLS/M, FLS-TS, FLRS, FLRS/M, FLLS, FLLS/N, FLLRS	265 kW		10/07→	☪ D2066LF38; 80A	8EL 738 211-251 Alternator	297
	265 kW		10/07→	☪ D2066LF38; 110A	8EL 738 211-261 Alternator	298
18.400 FAC, FHLC 18.400 FAK, FAK-L, FALK, FALK-L, FHLK, FHLK/M 18.400 FAS, FALS, FHLS, FHLS/M 18.400 FC, FLC, FLRC, FLLC, FLLRC, FLLW, FLLW/N 18.400 FK, FK-L, FLK, FLK/M 18.400 FLS, FLS/M, FLS-TS, FLRS, FLRS/M, FLLS, FLLS/N, FLLRS 24.400 FNLLW/N 24.400 FPLS, FPLRS	294 kW		10/07→	☪ D2066LF26; 80A	8EL 738 211-251 Alternator	297
	294 kW		10/07→	☪ D2066LF37; 80A	8EL 738 211-251 Alternator	297
	294 kW		10/07→	☪ D2066LF26; 110A	8EL 738 211-261 Alternator	298
	294 kW		10/07→	☪ D2066LF37; 110A	8EL 738 211-261 Alternator	298
	294 kW		10/07→	☪ D2066LF37; 120A	8EL 738 212-291 Alternator	298
	294 kW		10/07→			
	294 kW		10/07→			
18.440 FAC, FHLC 18.440 FAK, FAK-L, FALK, FALK-L, FHLK, FHLK/M 18.440 FAS, FALS, FHLS, FHLS/M 18.440 FC, FLC, FLRC, FLLC, FLLRC, FLLW, FLLW/N 18.440 FK, FK-L, FLK, FLK/M 18.440 FLS, FLS/M, FLS-TS, FLRS, FLRS/M, FLLS, FLLS/N, FLLRS 24.440 FNLLW/N 24.440 FPLS, FPLRS	324 kW		10/07→	☪ D2066LF25; 80A	8EL 738 211-251 Alternator	297
	324 kW		10/07→	☪ D2066LF36; 80A	8EL 738 211-251 Alternator	297
	324 kW		10/07→	☪ D2066LF36; 110A	8EL 738 211-261 Alternator	298
	324 kW		10/07→	☪ D2066LF25; 110A	8EL 738 211-261 Alternator	298
	324 kW		10/07→			
18.480 FAC, FHLC 18.480 FAK, FAK-L, FALK, FALK-L, FHLK, FHLK/M 18.480 FAS, FALS, FHLS 26.480 FDAC, FDALC, FDHLC, FDHLC/M 26.480 FDAK, FDALK, FDHK, FDHLK 26.480 FDAS, FDALS, FDHS, FDHLS 26.480 FDC, FDC/M, FDLC, FDLC/M, FDRC, FDRC/M, FDLRC, FNLHC 26.480 FDS, FDS/M, FDLS, FDLS/M, FDRS, FDLRS, FDRS/M, FNHLS 26.480 FNLS, FNLLS, FNLRS, FPLS, FPLRS, FVLS 28.480 FNLC 28.480 FNLS 32.480 FFD-TM 33.480 FDAC, FDALC 33.480 FDC, FDC/M, FDLC, FDLC/M 33.480 FDK, FDLK 33.480 FDS, FDLS, FDLS/M 35.480 FDNLC, FFDC, FFDLC 35.480 FFDAK 35.480 FFDK, FFDLK, FFDK 35.480 FFNLC 37.480 FFDC 37.480 FFDK 41.480 FFDAK 41.480 FFDC	353 kW		10/07→	☪ D2676LF07; 120A	8EL 738 212-291 Alternator	298
	353 kW		10/07→	☪ D2676LF05; 120A	8EL 738 212-291 Alternator	298
	353 kW		10/07→			
	353 kW		02/09→			
	353 kW		02/09→			
	353 kW		02/09→			
	353 kW		02/09→			
	353 kW		02/09→			
	353 kW		02/09→			
	353 kW		08/08→			
	353 kW		08/08→			
	353 kW		08/08→			
	353 kW		08/08→			
	353 kW		08/08→			
	353 kW		07/08→			
	353 kW		07/08→			
	353 kW		06/08→			
	353 kW		06/08→			
	353 kW		06/08→			
	353 kW		06/08→			
	353 kW		06/08→			
	353 kW		06/08→			
	353 kW		06/08→			
	353 kW		07/08→			
	353 kW		07/08→			
	353 kW		06/08→			
	353 kW		07/08→			

Manufacturer - Model	Power	Displ.	Year of Constr.	Remark	Part Number	Page
MAN - TGS						09/07→
41.480 FFDK	353 kW		07/08→	☺ D2676LF07; 120A	8EL 738 212-291 Alternator	298
				☺ D2676LF05; 120A	8EL 738 212-291 Alternator	298
18.480 FC, FLC, FLRC, FLLC, FLLRC, FLLW, FLLW/N	353 kW		10/07→	☺ D2676LF05; 80A	8EL 738 211-251 Alternator	297
18.480 FK, FK-L, FLK, FLK/M	353 kW		10/07→	☺ D2676LF14; 80A	8EL 738 211-251 Alternator	297
18.480 FLS, FLS/M, FLS-TS, FLRS, FLRS/M, FLLS, FLLS/N, FLLRS	353 kW		10/07→	☺ D2676LF05; 110A	8EL 738 211-261 Alternator	298
24.480 FPLS, FPLRS	353 kW		10/07→	☺ D2676LF14; 110A	8EL 738 211-261 Alternator	298
18.540 FAC, FHLC	397 kW		10/07→	☺ D2676LF13; 80A	8EL 738 211-251 Alternator	297
18.540 FAK, FAK-L, FALK, FALK-L, FHLK, FHLK/M	397 kW		10/07→	☺ D2676LF13; 110A	8EL 738 211-261 Alternator	298
18.540 FAS, FALS, FHLS, FHLS/M	397 kW		10/07→			
18.540 FC, FLC, FLRC, FLLC, FLLRC, FLLW, FLLW/N	397 kW		10/07→			
18.540 FLS, FLS/M, FLRS, FLRS/M, FLLS, FLLS/N, FLLRS	397 kW		10/07→			
24.540 FPLS, FPLRS	397 kW		10/07→			
18.540 FK, FK-L, FLK, FLK/M	397 kW		10/07→	☺ D2676LF13; 80A	8EL 738 211-251 Alternator	297
19.360 FS/M-WW, FLS/M-WW, FRS/M-WW, FLRS/M-WW	265 kW		02/11→	☺ D2066LF48; 80A	8EL 738 211-251 Alternator	297
				☺ D2066LF64; 80A	8EL 738 211-251 Alternator	297
				☺ D2066LF07; 80A	8EL 738 211-251 Alternator	297
				☺ D2066LF48; 110A	8EL 738 211-261 Alternator	298
				☺ D2066LF07; 110A	8EL 738 211-261 Alternator	298
				☺ D2066LF64; 110A	8EL 738 211-261 Alternator	298
				☺ D2066LF07; 120A	8EL 738 212-291 Alternator	298
				☺ D2066LF48; 120A	8EL 738 212-291 Alternator	298
☺ D2066LF64; 120A	8EL 738 212-291 Alternator	298				
19.400 FS/M-WW, FLS/M-WW, FRS/M-WW, FLRS/M-WW 40.400 FDAK-WW, FDARK-WW 40.400 FDAS-WW, FDARS-WW	294 kW 294 kW 294 kW		02/11→ 02/11→ 02/11→	☺ D2066LF49; 80A	8EL 738 211-251 Alternator	297
				☺ D2066LF63; 80A	8EL 738 211-251 Alternator	297
				☺ D2066LF06; 80A	8EL 738 211-251 Alternator	297
				☺ D2066LF49; 110A	8EL 738 211-261 Alternator	298
				☺ D2066LF06; 110A	8EL 738 211-261 Alternator	298
				☺ D2066LF63; 110A	8EL 738 211-261 Alternator	298
				☺ D2066LF06; 120A	8EL 738 212-291 Alternator	298
				☺ D2066LF49; 120A	8EL 738 212-291 Alternator	298
				☺ D2066LF63; 120A	8EL 738 212-291 Alternator	298
				☺ D2066LF50; 80A	8EL 738 211-251 Alternator	297
				☺ D2676LF04; 80A	8EL 738 211-251 Alternator	297
				☺ D2066LF62; 80A	8EL 738 211-251 Alternator	297
☺ D2066LF50; 110A	8EL 738 211-261 Alternator	298				
☺ D2066LF62; 110A	8EL 738 211-261 Alternator	298				
☺ D2676LF04; 110A	8EL 738 211-261 Alternator	298				
☺ D2676LF04; 120A	8EL 738 212-291 Alternator	298				

Manufacturer - Model	Power	Displ.	Year of Constr.	Remark	Part Number	Page
MAN - TGS						09/07→
19.440 FS-WW, FRS-WW, FLS-WW, FLRS-WW	324 kW		02/11→	☺ D2066LF50; 120A	8EL 738 212-291 Alternator	298
40.440 FDAK-WW, FDARK-WW	324 kW		02/11→	☺ D2066LF62; 120A	8EL 738 212-291 Alternator	298
40.440 FDAS-WW, FDARS-WW	324 kW		02/11→			
19.480 FS/M-WW, FRS/M-WW, FLS/M-WW, FLRS/M-WW	353 kW		02/11→	☺ D2676LF31; 80A	8EL 738 211-251 Alternator	297
				☺ D2676LF20; 80A	8EL 738 211-251 Alternator	297
				☺ D2676LF02; 80A	8EL 738 211-251 Alternator	297
				☺ D2676LF03; 80A	8EL 738 211-251 Alternator	297
				☺ D2676LF03; 110A	8EL 738 211-261 Alternator	298
				☺ D2676LF02; 110A	8EL 738 211-261 Alternator	298
				☺ D2676LF31; 110A	8EL 738 211-261 Alternator	298
				☺ D2676LF20; 110A	8EL 738 211-261 Alternator	298
				☺ D2676LF03; 120A	8EL 738 212-291 Alternator	298
				☺ D2676LF02; 120A	8EL 738 212-291 Alternator	298
				☺ D2676LF31; 120A	8EL 738 212-291 Alternator	298
				☺ D2676LF20; 120A	8EL 738 212-291 Alternator	298
24.320 FNLLW/N	235 kW		10/07→	☺ D2066LF28; 80A	8EL 738 211-251 Alternator	297
				☺ D2066LF28; 110A	8EL 738 211-261 Alternator	298
26.320 FDAC, FDALC, FDHLC, FDHLC/M	235 kW		07/08→	☺ D2066LF43; 110A	8EL 738 211-261 Alternator	298
26.320 FDK, FDLK	235 kW		07/08→	☺ D2066LF39; 110A	8EL 738 211-261 Alternator	298
26.320 FDS, FDLS, FDLRS/M, FDRS, FDLRS, FDLRS/M, FNHLS	235 kW		07/08→			
28.320 FNHLC	235 kW		07/08→			
28.320 FNLC	235 kW		07/08→			
35.320 FFDAK	235 kW		06/08→			
35.320 FFDK, FFDLK	235 kW		08/08→			
37.320 FFDC	235 kW		07/08→			
26.320 FDAK, FDALK, FDHK, FDHLK	235 kW		07/08→	☺ D2066LF43; 80A	8EL 738 211-251 Alternator	297
26.320 FDC, FDRC, FDLC, FDLC/M, FDLRC, FDLRC/M, FNHLC	235 kW		07/08→	☺ D2066LF39; 80A	8EL 738 211-251 Alternator	297
26.320 FD-TM	235 kW		07/08→			
26.320 FNLS, FNLRS, FNLLS, FPLS, FVLS	235 kW		07/08→			
35.320 FFDAK, FFDHLK	235 kW		06/08→			
35.320 FFDC, FFDLC, FDNLC	235 kW		06/08→			
35.320 FFNLC	235 kW		01/09→			
37.320 FFDK	235 kW		07/08→			
26.320 FNLC, FNLRC, FNLLC, FNLLRC, FNLLW, FVLC, FVL-KO	235 kW		10/07→	07/08→; ☺ D2066LF43; 80A	8EL 738 211-251 Alternator	297
				07/08→; ☺ D2066LF39; 80A	8EL 738 211-251 Alternator	297
				07/08→; ☺ D2066LF28; 80A	8EL 738 211-251 Alternator	297
26.320 FVHLC	235 kW		10/07→	☺ D2066LF39; 110A	8EL 738 211-261 Alternator	298
28.320 FNLS	235 kW		07/08→			
26.360 FDAC, FDALC, FDHLC, FDHLC/M	265 kW		08/08→	☺ D2066LF42; 110A	8EL 738 211-261 Alternator	298
26.360 FDC, FDRC, FDRC/M, FDLC, FDLRC, FNHLC	265 kW		08/08→	☺ D2066LF38; 110A	8EL 738 211-261 Alternator	298
26.360 FDK, FDLK, FDRK	265 kW		08/08→			
26.360 FDS, FDRS, FDRS/M, FDLS, FDLRS, FNHLS	265 kW		08/08→			
26.360 FNLLW	265 kW		04/08→			
28.360 FANLC, FNHLC	265 kW		08/08→			
28.360 FNLC	265 kW		08/08→			
28.360 FNLS	265 kW		08/08→			
33.360 FDK, FDLK	265 kW		02/09→			
35.360 FFDK, FFDLK, FFDRK	265 kW		08/08→			

Manufacturer - Model	Power	Displ.	Year of Constr.	Remark	Part Number	Page
MAN - TGS						09/07→
37.360 FFDC	265 kW		07/08→	☞ D2066LF42; 110A	8EL 738 211-261 Alternator	298
37.360 FFDC	265 kW		07/08→			
41.360 FFDC	265 kW		07/08→	☞ D2066LF38; 110A	8EL 738 211-261 Alternator	298
26.360 FDAK, FDALK, FDHK, FDHLK	265 kW		08/08→	☞ D2066LF42; 80A	8EL 738 211-251 Alternator	297
26.360 FDAS, FDALS, FDHS, FDHLS, FDHLS/M	265 kW		08/08→	☞ D2066LF38; 80A	8EL 738 211-251 Alternator	297
26.360 FD-TM	265 kW		07/08→			
26.360 FNLS, FNLLS, FNLRs, FPLS, FPLRS, FVLS	265 kW		08/08→			
33.360 FDAC, FDALC	265 kW		06/08→			
33.360 FDC, FDLC	265 kW		06/08→			
35.360 FFDAK	265 kW		06/08→			
35.360 FFDAK, FFHDLK	265 kW		06/08→			
35.360 FFDC, FFDLC, FDNLC	265 kW		06/08→			
35.360 FFNLC	265 kW		06/08→			
41.360 FFDAK	265 kW		06/08→			
26.360 FNLC, FNLRc, FNLLc, FNLLRC, FVLC, FVL-KO	265 kW		10/07→	08/08→; ☞ D2066LF42; 110A	8EL 738 211-261 Alternator	298
				08/08→; ☞ D2066LF27; 110A	8EL 738 211-261 Alternator	298
				08/08→; ☞ D2066LF38; 110A	8EL 738 211-261 Alternator	298
26.360 FPHLS	265 kW		05/08→	☞ D2066LF38; 80A	8EL 738 211-251 Alternator	297
26.360 FVHLC	265 kW		10/07→	☞ D2066LF38; 110A	8EL 738 211-261 Alternator	298
26.360 FVHLS	265 kW		05/08→			
28.360 FANLK	265 kW		08/08→			
32.360 FFDRc	265 kW		08/08→			
41.360 FFDC	265 kW		07/08→			
26.400 FDAC, FDALC, FDHLC, FDHLC/M	294 kW		02/09→	☞ D2066LF41; 80A	8EL 738 211-251 Alternator	297
26.400 FNLS, FNLRs, FNLLS, FNLLRS, FPLS, FPLRS, FVLS	294 kW		02/09→	☞ D2066LF37; 80A	8EL 738 211-251 Alternator	297
28.400 FANLC, FNHLC	294 kW		08/08→			
28.400 FNLC	294 kW		08/08→			
33.400 FDAC, FDALC	294 kW		07/08→			
33.400 FDAK, FDALK, FDHK	294 kW		07/08→			
33.400 FDC, FDLC	294 kW		06/08→			
33.400 FDK, FDLK	294 kW		07/08→			
35.400 FFDAK	294 kW		06/08→			
35.400 FFNLC	294 kW		06/08→			
37.400 FFDC	294 kW		07/08→			
41.400 FFDC	294 kW		07/08→			
41.400 FFDC	294 kW		07/08→			
26.400 FDAK, FDALK, FDHK, FDHLK	294 kW		11/07→	02/09→; ☞ D2066LF26; 110A	8EL 738 211-261 Alternator	298
26.400 FNLC, FNLRc, FNLLc, FNLLRC, FVLC, FVL-KO, FNLLW	294 kW		10/07→	02/09→; ☞ D2066LF37; 110A	8EL 738 211-261 Alternator	298
				02/09→; ☞ D2066LF41; 110A	8EL 738 211-261 Alternator	298
26.400 FDAS, FDALS, FDHS, FDHLS, FDHLS/M	294 kW		09/07→	02/09→; ☞ D2066LF37; 110A	8EL 738 211-261 Alternator	298
26.400 FDC, FDRc, FDC/M, FDLC, FDLC/M, FDLRC, FDLRC/M, FNHLC	294 kW		08/08→	02/09→; ☞ D2066LF41; 110A	8EL 738 211-261 Alternator	298
33.400 FDS, FDLS	294 kW		07/08→			
26.400 FDK, FDLK	294 kW		02/09→	☞ D2066LF41; 110A	8EL 738 211-261 Alternator	298
26.400 FDS, FDS/M, FDLS, FDLS/M, FDRS, FDLRS, FNHLS	294 kW		02/09→	☞ D2066LF37; 110A	8EL 738 211-261 Alternator	298
26.400 FD-TM	294 kW		07/08→			
28.400 FNLS	294 kW		08/08→			
35.400 FFDAK, FFHDLK	294 kW		06/08→			
35.400 FFDC, FFDLC, FDNLC	294 kW		06/08→			
35.400 FFDC, FFDLC, FDNLC	294 kW		06/08→			
35.400 FFDC, FFDLC, FDNLC	294 kW		08/08→			
37.400 FFDC	294 kW		07/08→			
26.400 FPHLS	294 kW		05/08→	☞ D2066LF37; 110A	8EL 738 211-261 Alternator	298
26.400 FVHLC	294 kW		10/07→			
26.400 FVHLS	294 kW		05/08→			
28.400 FANLK	294 kW		08/08→			
32.400 FFDRc	294 kW		08/08→			

Manufacturer - Model	Power	Displ.	Year of Constr.	Remark	Part Number	Page
MAN - TGS						09/07→
26.440 FDAC, FDALC, FDHLC, FDHLC/M	324 kW		02/09→	☺ D2066LF40; 80A	8EL 738 211-251 Alternator	297
26.440 FDC, FDR, FDC/M, FDLC, FDLC/M, FDLRC, FNHLC	324 kW		02/09→	☺ D2066LF36; 80A	8EL 738 211-251 Alternator	297
26.440 FD-TM	324 kW		07/08→			
28.440 FANLC, FNHLC	324 kW		08/08→			
37.440 FFDK	324 kW		07/08→			
41.440 FFDK	324 kW		06/08→			
41.440 FFDK	324 kW		07/08→			
26.440 FDAK, FDALK, FDHK, FDHLK	324 kW		11/07→	02/09→; ☺ D2066LF36; 110A	8EL 738 211-261 Alternator	298
				02/09→; ☺ D2066LF40; 110A	8EL 738 211-261 Alternator	298
26.440 FDAS, FDALS, FDHLS, FDHLS/M	324 kW		02/09→	☺ D2066LF40; 110A	8EL 738 211-261 Alternator	298
26.440 FDS, FDRS, FDS/M, FDLS, FDLRS, FNHLS	324 kW		02/09→	☺ D2066LF36; 110A	8EL 738 211-261 Alternator	298
26.440 FNLS, FNLLS, FNLRS, FPLS, FPLRS, FVLS	324 kW		02/09→			
28.440 FNLC	324 kW		08/08→			
28.440 FNLS	324 kW		08/08→			
37.440 FFDC	324 kW		07/08→			
41.440 FFDC	324 kW		07/08→			
26.440 FDK, FDLK	324 kW		07/08→	02/09→; ☺ D2066LF40; 80A	8EL 738 211-251 Alternator	297
				02/09→; ☺ D2066LF36; 80A	8EL 738 211-251 Alternator	297
26.440 FNLC, FNLLC, FNLLW, FNLR, FNLLRC, FVLC, FVL-KO	324 kW		10/07→	02/09→; ☺ D2066LF25; 110A	8EL 738 211-261 Alternator	298
				02/09→; ☺ D2066LF36; 110A	8EL 738 211-261 Alternator	298
				02/09→; ☺ D2066LF40; 110A	8EL 738 211-261 Alternator	298
26.440 FPHLS	324 kW		05/08→	☺ D2066LF36; 80A	8EL 738 211-251 Alternator	297
26.440 FVHLS	324 kW		05/08→			
28.440 FANLK	324 kW		08/08→			
26.440 FVHLC	324 kW		10/07→	☺ D2066LF36; 110A	8EL 738 211-261 Alternator	298
32.440 FFDRC	324 kW		08/08→			
26.480 FDK, FDLK	353 kW		07/08→	02/09→; ☺ D2676LF05; 120A	8EL 738 212-291 Alternator	298
				02/09→; ☺ D2676LF07; 120A	8EL 738 212-291 Alternator	298
26.480 FNLC, FNLR, FNLLC, FNLLRC, FNLLW, FVLC, FVL-KO	353 kW		10/07→	02/09→; ☺ D2676LF14; 120A	8EL 738 212-291 Alternator	298
				02/09→; ☺ D2676LF05; 120A	8EL 738 212-291 Alternator	298
				02/09→; ☺ D2676LF07; 120A	8EL 738 212-291 Alternator	298
26.480 FPHLS	353 kW		05/08→	☺ D2676LF05; 120A	8EL 738 212-291 Alternator	298
26.480 FVHLC	353 kW		10/07→			
26.480 FVHLS	353 kW		05/08→			
28.480 FANLC, FNHLC	353 kW		08/08→			
28.480 FANLK	353 kW		08/08→			
35.480 FFDK, FFDHLK	353 kW		06/08→			
41.480 FFDARC	353 kW		06/08→			
26.540 FDAC, FDALC, FDHLC, FDHLC/M	397 kW		02/09→	☺ D2676LF06; 120A	8EL 738 212-291 Alternator	298
26.540 FDAS, FDALS, FDHLS	397 kW		02/09→			
26.540 FDC, FDC/M, FDLC, FDLC/M, FDLRC, FDLRC/M, FNHLC	397 kW		02/09→			
26.540 FDK, FDLK	397 kW		02/09→			
26.540 FDS, FDS/M, FDLS, FDRS, FDLRS, FDLS/M, FNHLS	397 kW		02/09→			
26.540 FNLS, FNLLS, FPLS, FPLRS, FVLS	397 kW		02/09→			
28.540 FNHLC	397 kW		06/08→			
28.540 FNLC	397 kW		02/09→			
28.540 FNLS	397 kW		02/09→			
33.540 FDAC, FDALC	397 kW		02/09→			
33.540 FDAS, FDALS	397 kW		02/09→			
33.540 FDC, FDLC, FDLC/M	397 kW		02/09→			
33.540 FDK, FDLK	397 kW		02/09→			
33.540 FDS, FDLS, FDLS/M	397 kW		02/09→			
35.540 FDNLC, FFDC, FFDLC	397 kW		06/08→			
35.540 FFDK	397 kW		02/09→			
35.540 FFDK, FFDHLK	397 kW		02/09→			

Manufacturer - Model	Power	Displ.	Year of Constr.	Remark	Part Number	Page			
MAN - TGS						09/07→			
35.540 FFDK, FFDLK, FFDRK	397 kW		02/09→	☞ D2676LF06; 120A	8EL 738 212-291 Alternator	298			
35.540 FFNLC	397 kW		02/09→						
37.540 FFDC	397 kW		02/09→						
37.540 FFDK	397 kW		02/09→						
41.540 FFDAK	397 kW		02/09→						
41.540 FFDC	397 kW		02/09→						
41.540 FFDK	397 kW		02/09→						
26.540 FDAK, FDALK, FDHLK	397 kW		11/07→	02/09→; ☞ D2676LF13; 120A	8EL 738 212-291 Alternator	298			
26.540 FNLC, FNLRC, FNLLC, FNLLRC, FNLLW, FVLC, FVLKO	397 kW		10/07→	02/09→; ☞ D2676LF06; 120A	8EL 738 212-291 Alternator	298			
32.320 FFD-TM	235 kW		02/09→	☞ D2066LF43; 80A	8EL 738 211-251 Alternator	297			
41.320 FFDAK	235 kW		06/08→						
32.360 FFD-TM, FFDR-TM	265 kW		10/07→	☞ D2066LF42; 80A	8EL 738 211-251 Alternator	297			
41.360 FFD-TM	265 kW		10/07→						
				☞ D2066LF38; 80A	8EL 738 211-251 Alternator	297			
				☞ D2066LF27; 80A	8EL 738 211-251 Alternator	297			
32.400 FFD-TM, FFDR-TM	294 kW		10/07→	☞ D2066LF26; 110A	8EL 738 211-261 Alternator	298			
35.400 FFD-TM	294 kW		10/07→						
				☞ D2066LF41; 110A	8EL 738 211-261 Alternator	298			
				☞ D2066LF37; 110A	8EL 738 211-261 Alternator	298			
32.440 FFD-TM, FFDR-TM	324 kW		10/07→	☞ D2066LF40; 80A	8EL 738 211-251 Alternator	297			
37.440 FFD-TM	324 kW		10/07→						
				☞ D2066LF36; 80A	8EL 738 211-251 Alternator	297			
				☞ D2066LF25; 80A	8EL 738 211-251 Alternator	297			
33.360 FDAK, FDALK, FDHK	265 kW		10/07→	02/09→; ☞ D2066LF42; 80A	8EL 738 211-251 Alternator	297			
				02/09→; ☞ D2066LF27; 80A	8EL 738 211-251 Alternator	297			
33.360 FDAS, FDALS, FDHS	265 kW		10/07→	06/08→; ☞ D2066LF42; 80A	8EL 738 211-251 Alternator	297			
				06/08→; ☞ D2066LF38; 80A	8EL 738 211-251 Alternator	297			
33.360 FDS, FDLS	265 kW		06/08→	02/09→; ☞ D2066LF38; 110A	8EL 738 211-261 Alternator	298			
				02/09→; ☞ D2066LF42; 110A	8EL 738 211-261 Alternator	298			
33.440 FDAC, FDALC	324 kW		07/08→	☞ D2066LF36; 120A	8EL 738 212-291 Alternator	298			
33.440 FDC, FDLC	324 kW		06/08→						
33.440 FDK, FDLK	324 kW		06/08→						
33.440 FDS, FDLS, FDLS/M	324 kW		06/08→						
35.440 FDNLC, FFDC, FFDLC, FFNLC	324 kW		06/08→						
35.440 FFDAK	324 kW		06/08→						
35.440 FFDAK, FFDHLK	324 kW		06/08→						
35.440 FFDK, FFDLK, FFDRK	324 kW		08/08→						
35.440 FFNLC	324 kW		06/08→						
33.440 FDAK, FDALK, FDHK	324 kW		11/07→				07/08→; ☞ D2066LF25; 120A	8EL 738 212-291 Alternator	298
							07/08→; ☞ D2066LF40; 120A	8EL 738 212-291 Alternator	298
							07/08→; ☞ D2066LF36; 120A	8EL 738 212-291 Alternator	298
33.440 FDAS, FDALS, FDHS	324 kW		10/07→				06/08→; ☞ D2066LF40; 120A	8EL 738 212-291 Alternator	298
				06/08→; ☞ D2066LF36; 120A	8EL 738 212-291 Alternator	298			
33.480 FDAK, FDALK	353 kW		08/08→	☞ D2676LF07; 120A	8EL 738 212-291 Alternator	298			
35.480 FFD-TM	353 kW		10/07→						
37.480 FFD-TM	353 kW		10/07→						
41.480 FFD-TM	353 kW		10/07→						
				☞ D2676LF05; 120A	8EL 738 212-291 Alternator	298			
				☞ D2676LF14; 120A	8EL 738 212-291 Alternator	298			
33.480 FDAS, FDALS, FDHS	353 kW		10/07→	08/08→; ☞ D2676LF07; 120A	8EL 738 212-291 Alternator	298			
				08/08→; ☞ D2676LF05; 120A	8EL 738 212-291 Alternator	298			

Manufacturer - Model	Power	Displ.	Year of Constr.	Remark	Part Number	Page
MAN - TGS						09/07→
33.540 FDAK, FDALK	397 kW		02/09→	☞ D2676LF06; 120A	8EL 738 212-291	298
35.540 FFD-TM	397 kW		10/07→		Alternator	
37.540 FFD-TM	397 kW		10/07→	☞ D2676LF13; 120A	8EL 738 212-291	298
41.540 FFD-TM	397 kW		10/07→		Alternator	
35.320 FFD-TM	235 kW		10/07→	☞ D2066LF28; 110A	8EL 738 211-261	298
37.320 FFD-TM	235 kW		10/07→		Alternator	
				☞ D2066LF43; 110A	8EL 738 211-261	298
					Alternator	
				☞ D2066LF39; 110A	8EL 738 211-261	298
					Alternator	
35.360 FFD-TM	265 kW		10/07→	☞ D2066LF27; 110A	8EL 738 211-261	298
37.360 FFD-TM	265 kW		10/07→		Alternator	
				☞ D2066LF42; 110A	8EL 738 211-261	298
					Alternator	
				☞ D2066LF38; 110A	8EL 738 211-261	298
					Alternator	
35.400 FFNHLC	294 kW		10/07→	☞ D2066LF26; 110A	8EL 738 211-261	298
					Alternator	
				☞ D2066LF37; 110A	8EL 738 211-261	298
					Alternator	
35.440 FFD-TM	324 kW		10/07→	☞ D2066LF25; 120A	8EL 738 212-291	298
					Alternator	
				☞ D2066LF36; 120A	8EL 738 212-291	298
					Alternator	
				☞ D2066LF40; 120A	8EL 738 212-291	298
					Alternator	
35.440 FFNHLC	324 kW		10/07→	☞ D2066LF25; 120A	8EL 738 212-291	298
					Alternator	
				☞ D2066LF36; 120A	8EL 738 212-291	298
					Alternator	
35.480 FFNHLC	353 kW		10/07→	☞ D2676LF05; 120A	8EL 738 212-291	298
					Alternator	
				☞ D2676LF14; 120A	8EL 738 212-291	298
					Alternator	
37.400 FFD-TM	294 kW		10/07→	☞ D2066LF41; 80A	8EL 738 211-251	297
41.400 FFD-TM	294 kW		10/07→		Alternator	
				☞ D2066LF37; 80A	8EL 738 211-251	297
					Alternator	
				☞ D2066LF26; 80A	8EL 738 211-251	297
					Alternator	
41.440 FFD-TM	324 kW		10/07→	☞ D2066LF25; 110A	8EL 738 211-261	298
					Alternator	
				☞ D2066LF40; 110A	8EL 738 211-261	298
					Alternator	
				☞ D2066LF36; 110A	8EL 738 211-261	298
					Alternator	
MAN - TGX						09/07→
18.360 FHLC	265 kW		10/07→	☞ 939B5.000; 80A	8EL 738 211-251	297
					Alternator	
				☞ D2066LF27; 80A	8EL 738 211-251	297
					Alternator	
				☞ D2066LF27; 110A	8EL 738 211-261	298
					Alternator	
				☞ 939B5.000; 110A	8EL 738 211-261	298
					Alternator	
18.360 FHLS, FHLS/M	265 kW		10/07→	☞ D2066LF27; 80A	8EL 738 211-251	297
18.360 FLC, FLRC, FLLC,	265 kW		10/07→		Alternator	
FLLRC, FLLW, FLLW/N				☞ D2066LF38; 80A	8EL 738 211-251	297
18.360 FLS, FLS/M, FLRS,	265 kW		10/07→		Alternator	
FLRS/N, FLLS, FLLS/N,				☞ D2066LF27; 110A	8EL 738 211-261	298
FLLRS, FLLRS/N					Alternator	
24.360 FNLLW/N	265 kW		10/07→			
24.360 FPLS, FPLRS	265 kW		10/07→	☞ D2066LF38; 110A	8EL 738 211-261	298
26.360 FNLC, FNLRC, FNLLC,	265 kW		10/07→		Alternator	
FNLLRC, FNLLW						
26.360 FNLS, FNLLS, FNLRs,	265 kW		10/07→			
FNLLRS, FPLS, FPLRS, FVLS						
28.360 FNLC	265 kW		10/07→			
28.360 FNLS	265 kW		10/07→			
33.360 FDC, FDC/M, FDLC	265 kW		10/07→			
33.360 FDS, FDS/M, FDLS,	265 kW		10/07→			
FDLS/M						
35.360 FDNLC	265 kW		06/08→			

Manufacturer - Model	Power	Displ.	Year of Constr.	Remark	Part Number	Page
MAN - TGX						09/07→
18.400 FHLC	294 kW		10/07→	☞ D2066LF26; 80A	8EL 738 211-251	297
18.400 FHLS, FHLS/M	294 kW		10/07→		Alternator	
18.400 FLC, FLRC, FLLC, FLLRC, FLLW, FLLW/N	294 kW		10/07→	☞ D2066LF37; 80A	8EL 738 211-251	297
					Alternator	
18.400 FLS, FLS/M, FLRS, FLRS/N, FLLS, FLLS/N, FLLRS, FLLRS/N	294 kW		10/07→	☞ D2066LF37; 110A	8EL 738 211-261	298
					Alternator	
24.400 FNLLW/N	294 kW		10/07→	☞ D2066LF26; 110A	8EL 738 211-261	298
24.400 FPLS, FPLRS	294 kW		10/07→		Alternator	
26.400 FNLC, FNLC, FNLLC, FNLLRC, FNLLW	294 kW		10/07→	☞ D2066LF37; 120A	8EL 738 212-291	298
					Alternator	
26.400 FNLS, FNLLS, FNLRs, FNLLRS, FPLS, FPLRS, FVLS	294 kW		10/07→			
28.400 FNLC	294 kW		10/07→			
28.400 FNLS	294 kW		10/07→			
33.400 FDC, FDC/M, FDLC	294 kW		10/07→			
33.400 FDS, FDS/M, FDLS, FDLS/M	294 kW		10/07→			
18.440 FHLC	324 kW		10/07→	☞ D2066LF25; 80A	8EL 738 211-251	297
18.440 FHLS, FHLS/M	324 kW		10/07→		Alternator	
18.440 FLC, FLRC, FLLC, FLLRC, FLLW, FLLW/N	324 kW		10/07→	☞ D2066LF36; 80A	8EL 738 211-251	297
					Alternator	
18.440 FLS, FLS/M, FLRS, FLRS/M, FLLS, FLLS/N, FLLRS, FLLRS/	324 kW		10/07→	☞ D2066LF25; 110A	8EL 738 211-261	298
					Alternator	
24.440 FNLLW/N	324 kW		10/07→	☞ D2066LF36; 110A	8EL 738 211-261	298
24.440 FPLS, FPLRS	324 kW		10/07→		Alternator	
26.440 FNLC, FNLC, FNLLC, FNLLRC, FNLLW	324 kW		10/07→			
26.440 FNLS, FNLLS, FNLRs, FNLLRS, FPLS, FPLRS, FVLS	324 kW		10/07→			
28.440 FNLC	324 kW		10/07→			
28.440 FNLS	324 kW		10/07→			
33.440 FDC, FDC/M, FDLC	324 kW		10/07→			
33.440 FDS, FDS/M, FDLS, FDLS/M	324 kW		10/07→			
35.440 FDNLC	324 kW		06/08→			
18.440 FLRC	324 kW		10/07→	☞ D2676LF22; 120A	8EL 738 212-291	298
18.440 FLRS	324 kW		10/07→		Alternator	
24.440 FPLRS	324 kW		10/07→			
26.440 FPLRS	324 kW		07/08→			
18.480 FHLC	353 kW		10/07→	☞ D2676LF05; 80A	8EL 738 211-251	297
18.480 FHLS, FHLS/M	353 kW		10/07→		Alternator	
18.480 FLC, FLRC, FLLC, FLLRC, FLLW, FLLW/N	353 kW		10/07→	☞ D2676LF14; 80A	8EL 738 211-251	297
					Alternator	
18.480 FLS, FLS/M, FLRS, FLRS/N, FLLS, FLLS/N, FLLRS, FLLRS/N	353 kW		10/07→	☞ D2676LF05; 110A	8EL 738 211-261	298
					Alternator	
24.480 FNLLW/N	353 kW		10/07→	☞ D2676LF14; 110A	8EL 738 211-261	298
24.480 FPLS, FPLRS	353 kW		10/07→		Alternator	
26.480 FNLC, FNLC, FNLLC, FNLLRC, FNLLW	353 kW		10/07→			
26.480 FNLS, FNLLS, FNLRs, FNLLRS, FPLS, FPLRS, FVLS	353 kW		10/07→			
28.480 FNLC	353 kW		10/07→			
28.480 FNLS	353 kW		10/07→			
33.480 FDC, FDC/M, FDLC	353 kW		10/07→			
33.480 FDS, FDS/M, FDLS, FDLS/M	353 kW		10/07→			
35.480 FDNLC	353 kW		06/08→			
18.540 FHLC	397 kW		10/07→	☞ D2676LF13; 80A	8EL 738 211-251	297
18.540 FHLS, FHLS/M	397 kW		10/07→		Alternator	
18.540 FLC, FLRC, FLLC, FLLRC, FLLW, FLLW/N	397 kW		10/07→	☞ D2676LF13; 110A	8EL 738 211-261	298
					Alternator	
18.540 FLS, FLS/M, FLRS, FLRS/N, FLLS, FLLS/ N, FLLRS, FLLRS/N	397 kW		10/07→			
24.540 FPLS, FPLRS	397 kW		10/07→			
26.540 FNLC, FNLC, FNLLC, FNLLRC, FNLLW	397 kW		10/07→			
28.540 FNLC	397 kW		10/07→			
33.540 FDC, FDC/M, FDLC	397 kW		10/07→			
33.540 FDS, FDS/M, FDLS, FDLS/M	397 kW		10/07→			
35.540 FDNLC	397 kW		06/08→			
41.540 FVDS, FVDLS	397 kW		06/08→			

Manufacturer - Model	Power	Displ.	Year of Constr.	Remark	Part Number	Page
MAN - TGX						09/07→
18.680 FLS	500 kW		10/07→	☞ D2868LF03; 80A	8EL 738 211-251 Alternator	297
				☞ D2868LF02; 80A	8EL 738 211-251 Alternator	297
				☞ D2868LF02; 110A	8EL 738 211-261 Alternator	298
				☞ D2868LF03; 110A	8EL 738 211-261 Alternator	298
				☞ D2868LF03; 120A	8EL 738 212-291 Alternator	298
				☞ D2868LF02; 120A	8EL 738 212-291 Alternator	298
24.540 FNLLW/N	397 kW		02/09→	☞ D2676LF06; 120A	8EL 738 212-291 Alternator	298
26.540 FDC, FDLC, FDRC, FDLRC	397 kW		02/09→			
26.540 FDS, FDLS, FDRS, FDLRS	397 kW		02/09→			
28.540 FNLS	397 kW		02/09→			
26.320 FNLS, FNLLS	235 kW		10/07→	☞ D2066LF28; 80A	8EL 738 211-251 Alternator	297
				☞ D2066LF28; 110A	8EL 738 211-261 Alternator	298
26.360 FDC, FDLC, FDRC, FDLRC	265 kW		07/08→	☞ D2066LF42; 110A	8EL 738 211-261 Alternator	298
				☞ D2066LF38; 110A	8EL 738 211-261 Alternator	298
26.360 FDHLC	265 kW		10/07→	☞ D2066LF38; 110A	8EL 738 211-261 Alternator	298
26.360 FDHLS	265 kW		10/07→	☞ D2066LF38; 80A	8EL 738 211-251 Alternator	297
26.360 FNHLC	265 kW		10/07→			
26.360 FNHLS	265 kW		12/07→			
26.360 FVHLS	265 kW		05/08→			
26.360 FDS, FDLS, FDRS, FDLRS	265 kW		07/08→	☞ D2066LF42; 80A	8EL 738 211-251 Alternator	297
				☞ D2066LF38; 80A	8EL 738 211-251 Alternator	297
26.400 FDC, FDLC, FDRC, FDLRC	294 kW		07/08→	☞ D2066LF37; 80A	8EL 738 211-251 Alternator	297
26.400 FDHLC	294 kW		10/07→			
26.400 FDHLS	294 kW		10/07→			
26.400 FNHLC	294 kW		12/07→			
26.400 FNHLS	294 kW		12/07→			
26.400 FPHLS	294 kW		05/08→			
26.400 FVHLS	294 kW		05/08→			
26.400 FDS, FDLS, FDRS, FDLRS	294 kW		07/08→			
26.440 FDC, FDLC, FDRC, FDLRC	324 kW		07/08→	☞ D2066LF40; 80A	8EL 738 211-251 Alternator	297
26.440 FDS, FDLS, FDRS, FDLRS	324 kW		07/08→	☞ D2066LF36; 80A	8EL 738 211-251 Alternator	297
26.440 FDHLC	324 kW		09/07→	☞ D2066LF36; 80A	8EL 738 211-251 Alternator	297
26.440 FDHLS	324 kW		10/07→			
26.440 FNHLC	324 kW		12/07→			
26.440 FNHLS	324 kW		12/07→	☞ D2066LF36; 110A	8EL 738 211-261 Alternator	298
26.440 FPHLS	324 kW		05/08→			
26.440 FVHLS	324 kW		05/08→			
26.480 FDC, FDLC, FDRC, FDLRC	353 kW		07/08→	☞ D2676LF07; 120A	8EL 738 212-291 Alternator	298
26.480 FDS, FDLS, FDRS, FDLRS	353 kW		07/08→	☞ D2676LF05; 120A	8EL 738 212-291 Alternator	298
26.480 FDHLC	353 kW		09/07→	☞ D2676LF05; 120A	8EL 738 212-291 Alternator	298
26.480 FDHLS	353 kW		10/07→			
26.480 FNHLC	353 kW		12/07→			
26.480 FNHLS	353 kW		12/07→			
26.480 FPHLS	353 kW		05/08→			
26.480 FVHLS	353 kW		05/08→			
26.540 FNLS, FNLRS, FNLLS, FPLS, FPLRS, FVLS	397 kW		10/07→	☞ D2676LF13; 120A	8EL 738 212-291 Alternator	298

Manufacturer - Model	Power	Displ.	Year of Constr.	Remark	Part Number	Page
MAN - TGX						09/07→
33.680 FDLC 33.680 FDLS	500 kW 500 kW		10/07→ 10/07→	☺ D2868LF02; 80A	8EL 738 211-251 Alternator	297
				☺ D2868LF02; 110A	8EL 738 211-261 Alternator	298
				☺ D2868LF02; 120A	8EL 738 212-291 Alternator	298
35.400 FDNLC	294 kW		06/08→	☺ D2066LF26; 80A	8EL 738 211-251 Alternator	297
				☺ D2066LF37; 80A	8EL 738 211-251 Alternator	297
				☺ D2066LF26; 110A	8EL 738 211-261 Alternator	298
				☺ D2066LF37; 110A	8EL 738 211-261 Alternator	298
41.680 FVDS, FVDLS	500 kW		10/07→	☺ D2868LF03; 80A	8EL 738 211-251 Alternator	297
				☺ D2868LF03; 110A	8EL 738 211-261 Alternator	298
				☺ D2868LF03; 120A	8EL 738 212-291 Alternator	298
MAN - ÜL						09/89→
ÜL 242	177 kW		09/89→03/93	11/92→; →03/93; ☺ D2866UH/240; 140A	8EL 737 365-001 Alternator	296
ÜL 272	198 kW		03/93→	03/93→; →07/94; ☺ D2865LUH02; 140A	8EL 737 365-001 Alternator	296
				03/93→; →09/95; ☺ D2865LUH05; 140A	8EL 737 365-001 Alternator	296
ÜL 292	213 - 222 kW		09/89→03/93	☺ D2866TUH01; 55A	8EL 725 736-001 Alternator	294
				11/92→; →03/93; ☺ D2866TUH01; 140A	8EL 737 365-001 Alternator	296
ÜL 312, ÜL 322	228 - 235 kW		04/92→09/96	☺ D2865LUH07; 140A	8EL 737 365-001 Alternator	296
				☺ D2865LUH08; 140A	8EL 737 365-001 Alternator	296
ÜL 313	228 kW		09/96→	09/96→; →09/01; ☺ D2866LUH26; 140A	8EL 737 365-001 Alternator	296
				09/96→; →09/01; ☺ D2866LUH20; 140A	8EL 737 365-001 Alternator	296
ÜL 353	257 kW		06/97→	06/97→; →12/01; ☺ D2866LUH21; 140A	8EL 737 365-001 Alternator	296

CUMMINS	HELLA	MERCEDES- BENZ	HELLA
3255439	8EL 725 736-001	A 000 154 24 06	5DR 009 728-441
DAF	HELLA	A 000 154 26 05	5DR 009 728-441
127 4480	8EL 725 736-001	A 000 154 27 05	5DR 009 728-441
129 8995	8EL 732 707-001	A 000 154 38 05	5DR 009 728-441
1357591	8EL 725 736-001	A 003 154 26 06	5DR 009 728-441
135 7592	8EL 725 736-001	A 005 154 33 02	8EL 725 625-001
135 7593	8EL 732 707-001	A 005 154 34 02	8EL 725 736-001
DEUTZ-FAHR	HELLA	A 005 154 52 02	8EL 725 625-001
117 8511	8EL 732 707-001	A 005 154 60 02	8EL 725 625-001
FORD	HELLA	A 006 154 24 02	8EL 725 625-001
1 021 198	8EL 731 715-001	A 007 154 23 02	8EL 725 625-001
1 612 497	8EL 725 663-001	A 007 154 27 02	8EL 725 736-001
5 008 758	8EL 725 663-001	A 007 154 92 02	8EL 732 707-001
IVECO	HELLA	A 007 154 92 02 80	8EL 732 707-001
5003 32014	8EL 737 365-001	A 007 154 99 02	8EL 732 707-001
5 003 320 14 4	8EL 737 365-001	A 009 154 06 02	8EL 731 715-001
LOMBARDINI	HELLA	A 009 154 07 02	8EL 725 736-001
SA369	8EL 737 052-001	A 009 154 15 02	8EL 731 715-001
SA707	8EL 725 625-001	A 009 154 15 02 80	8EL 731 715-001
MAN	HELLA	A 009 154 34 02	8EL 731 715-001
51.26101.6084	8EL 737 365-001	A 009 154 97 02	8EL 732 707-001
51.26101.7133	8EL 725 644-001	A 009 154 98 02	8EL 732 707-001
51.26101.7138	8EL 725 729-001	A 009 154 98 02 80	8EL 732 707-001
51.26101.7144	8EL 725 736-001	A 010 154 20 02	8EL 725 736-001
51.26101.7145	8EL 725 625-001	A 010 154 90 02	8EL 732 707-001
51.26101.7156	8EL 725 663-001	A 010 154 91 02 87	8EL 732 707-001
51.26101.7159	8EL 730 008-001	A 012 154 04 02	5DR 009 728-441
51.26101.7184	8EL 725 729-001	A 012 154 05 02	5DR 009 728-441
51.26101.7184	8EL 730 008-001	A 012 154 10 02	5DR 009 728-441
51.26101.7185	8EL 725 736-001	A 012 154 11 02	5DR 009 728-441
51.26101.7190	8EL 725 663-001	A 012 154 67 02	5DR 009 728-441
51.26101.7200	8EL 725 729-001	A 013 154 43 02	5DR 009 728-441
51.26101.7201	8EL 725 736-001	A 366 150 23 50	8EL 731 715-001
51.26101.7242	8EL 737 985-001	MERCEDES- BENZ (BBDC)	HELLA
51.26101.7247	8EL 737 985-001	0121541002	5DR 009 728-441
51.26101.9144	8EL 725 736-001	RENAULT	HELLA
51.26101.9185	8EL 725 736-001	50 01 837 972	8EL 732 707-001
51.26101-7278	8EL 738 212-291	50 10 217 961	8EL 732 707-001
51.26101-7283	8EL 738 212-291	77 00 855 154	8EL 737 052-001
51 26101 7232	8EL 737 985-001	VW	HELLA
51 26101 7234	8EL 737 985-001	2TB 903 803 A	5DR 009 728-441
51 26101 7241	8EL 738 055-001		
51 26101 7246	8EL 738 211-261		
51 26101 7249	8EL 738 211-251		
51 26101 7265	8EL 737 985-001		
51 26101 7269	8EL 738 211-021		
51 26101 9133	8EL 725 644-001		
51 26101 9197	8EL 725 644-001		
81.26101.6079	8EL 737 365-001		
81.26101.6081	8EL 737 365-001		
81.26101.6086	8EL 737 365-001		
81 26101 6084	8EL 737 365-001		
MERCEDES- BENZ	HELLA		
000 154 24 05	5DR 009 728-441		
000 154 24 06	5DR 009 728-441		
000 154 26 05	5DR 009 728-441		
000 154 27 05	5DR 009 728-441		
000 154 38 05	5DR 009 728-441		
003 154 26 06	5DR 009 728-441		
005 154 33 02	8EL 725 625-001		
005 154 34 02	8EL 725 736-001		
005 154 52 02	8EL 725 625-001		
005 154 60 02	8EL 725 625-001		
006 154 24 02	8EL 725 625-001		
007 154 23 02	8EL 725 625-001		
007 154 23 02 80	8EL 725 625-001		
007 154 27 02	8EL 725 736-001		
007 154 92 02	8EL 732 707-001		
007 154 92 02 80	8EL 732 707-001		
007 154 99 02	8EL 732 707-001		
009 154 06 02	8EL 731 715-001		
009 154 07 02	8EL 725 736-001		
009 154 15 02	8EL 731 715-001		
009 154 15 02 80	8EL 731 715-001		
009 154 34 02	8EL 731 715-001		
009 154 97 02	8EL 732 707-001		
009 154 98 02	8EL 732 707-001		
009 154 98 02 80	8EL 732 707-001		
010 154 20 02	8EL 725 736-001		
010 154 90 02	8EL 732 707-001		
010 154 91 02 87	8EL 732 707-001		
012 154 04 02	5DR 009 728-441		
012 154 05 02	5DR 009 728-441		
012 154 10 02	5DR 009 728-441		
012 154 11 02	5DR 009 728-441		
012 154 67 02	5DR 009 728-441		
013 154 43 02	5DR 009 728-441		
366 150 23 50	8EL 731 715-001		
A 000 154 24 05	5DR 009 728-441		

**5DR ...**

5DR 009 728-441	298
-----------------	-----

8EL ...

8EL 725 625-001	292
8EL 725 644-001	292
8EL 725 663-001	293
8EL 725 729-001	293
8EL 725 736-001	294
8EL 730 008-001	294
8EL 731 715-001	295
8EL 732 707-001	295
8EL 737 052-001	296
8EL 737 365-001	296
8EL 737 985-001	296
8EL 738 055-001	297
8EL 738 211-021	297
8EL 738 211-251	297
8EL 738 211-261	298
8EL 738 212-291	298



Compressor, air conditioning.....	401
Condenser, air conditioning.....	404
Dryer, air conditioning.....	408
Evaporator, air conditioning.....	409
Expansion Valve, air conditioning.....	410

Compressor, air conditioning

8FK 351 119-361
BEHR HELLA SERVICE

IMPORTANT: OBSERVE FITTING INSTRUCTIONS



Belt Pulley Ø [mm]	132
Compressor ID	SD7H15
Compressor Oil	PAG 46
Cylinder Head ID (Compressor)	KH
New Part	1
Number of Ribs	2
Pulleys	with double pulley
Rated Voltage [V]	24
Refrigerant	R 134a

8FK 351 126-201
BEHR HELLA SERVICE

IMPORTANT: OBSERVE FITTING INSTRUCTIONS



Belt Pulley Ø [mm]	132
Compressor ID	SD7H15
Compressor Oil	PAG 46
Cylinder Head ID (Compressor)	JE
New Part	1
Number of Ribs	2
Port Type	V/OR
Pulleys	with double pulley
Rated Voltage [V]	24
Refrigerant	R 134a

Compressor, air conditioning

8FK 351 135-141
BEHR HELLA SERVICE

IMPORTANT: OBSERVE FITTING INSTRUCTIONS

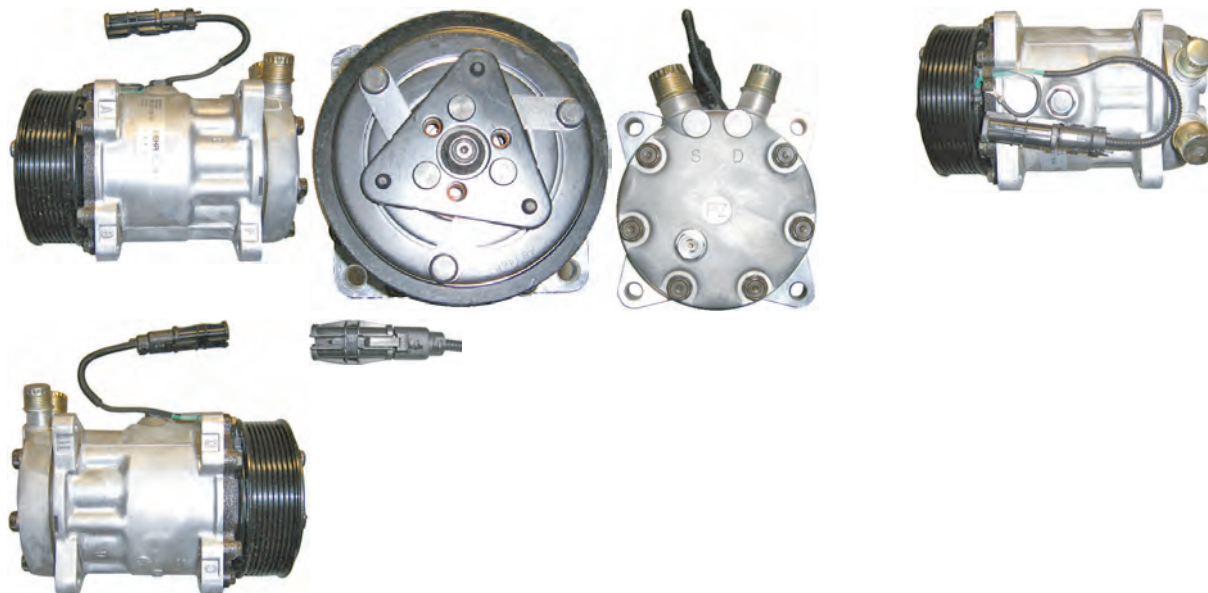

Belt Pulley Ø [mm]	119
Compressor ID	SD7H15
Compressor Oil	PAG 46
Cylinder Head ID (Compressor)	FZ
New Part	1
Number of Ribs	8
Port Type	TO
Pulleys	with v-ribbed belt pulley
Rated Voltage [V]	24
Refrigerant	R 134a

8FK 351 135-231
BEHR HELLA SERVICE

IMPORTANT: OBSERVE FITTING INSTRUCTIONS



Belt Pulley Ø [mm]	119	Port Type	H/PAD
Compressor ID	SD7H15	Pulleys	with v-ribbed belt pulley
Compressor Oil	PAG 46	Rated Voltage [V]	24
Cylinder Head ID (Compressor)	KH	Refrigerant	R 134a
New Part	1		
Number of Ribs	8		

Compressor, air conditioning

8FK 351 135-641
BEHR HELLA SERVICE

- BEHR HELLA SERVICE Version ALTERNATIVE - The alternative for repairs in relation to the current value of the car
IMPORTANT: OBSERVE FITTING INSTRUCTIONS

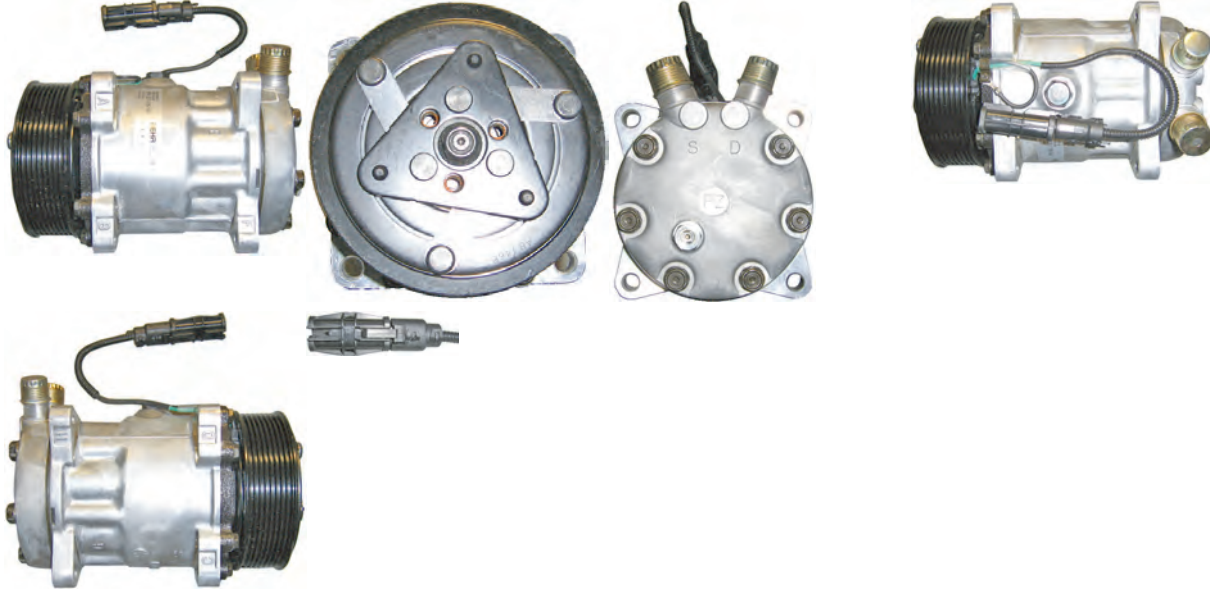

additional article information	BEHR HELLA SERVICE Version ALTERNATIVE
Belt Pulley Ø [mm]	119
Compressor ID	SD7H15
Compressor Oil	PAG 46
Cylinder Head ID (Compressor)	FZ
Number of Ribs	8
Port Type	TO
Pulleys	with v-ribbed belt pulley
Rated Voltage [V]	24
Refrigerant	R 134a

Condenser, air conditioning

8FC 351 029-371
BEHR HELLA SERVICE

KOMO (Condenser Module)



Depth [mm]	16
Length [mm]	590
Supplementary Article/Supplementary Info 2	with dryer
Version	produced by BEHR
Width [mm]	479

8FC 351 300-061
BEHR HELLA SERVICE

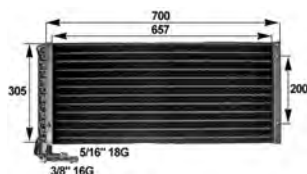

Depth [mm]	33
Length [mm]	678
Supplementary Article/Supplementary Info 2	without dehumidifier
Version	produced by BEHR
Width [mm]	304

Condenser, air conditioning

8FC 351 300-071
BEHR HELLA SERVICE

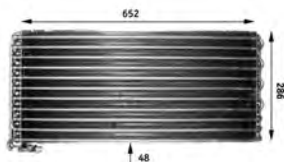

Depth [mm]	48
Length [mm]	652
Supplementary Article/Supplementary Info 2	without dehumidifier
Version	produced by BEHR
Width [mm]	286

8FC 351 300-121
BEHR HELLA SERVICE

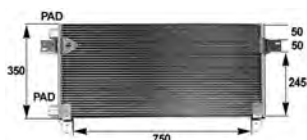

Depth [mm]	16
Length [mm]	750
Supplementary Article/Supplementary Info 2	without dehumidifier
Version	produced by BEHR
Width [mm]	351

8FC 351 301-021
BEHR HELLA SERVICE

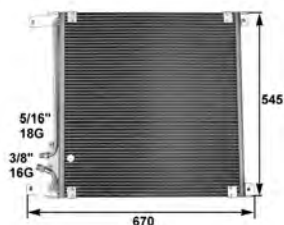

Depth [mm]	16
Length [mm]	545
Supplementary Article/Supplementary Info 2	without dehumidifier
Width [mm]	520

Condenser, air conditioning

8FC 351 306-061
BEHR HELLA SERVICE

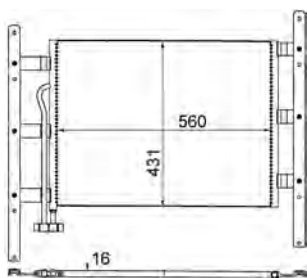

Depth [mm]	16
for OE number	81619200017
Length [mm]	560
Supplementary Article/Supplementary Info 2	without dehumidifier
Width [mm]	431

8FC 351 306-071
BEHR HELLA SERVICE

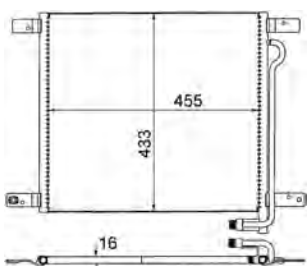

Depth [mm]	16
for OE number	81619206028
Length [mm]	455
Supplementary Article/Supplementary Info 2	without dehumidifier
Width [mm]	433

8FC 351 317-611
BEHR HELLA SERVICE

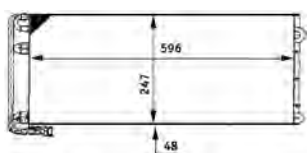

Depth [mm]	48	Version	produced by BEHR
Length [mm]	596	Width [mm]	247
Supplementary Article/Supplementary Info 2	without dehumidifier		

Condenser, air conditioning

8FC 351 319-471
 BEHR HELLA SERVICE



Depth [mm]	16
Inner Diameter 1 [mm]	14.35
Inner Diameter 2 [mm]	11.05
Length [mm]	765
Supplementary Article/Supplementary Info 2	with dryer
Version	produced by BEHR
Width [mm]	351

Dehumidifier - Dryer, air conditioning

8FT 351 193-201
BEHR HELLA SERVICE



Diameter [mm]	37.1
Length [mm]	400

8FT 351 197-481
BEHR HELLA SERVICE



Diameter [mm]	45
Length [mm]	405

8FT 351 198-481
BEHR HELLA SERVICE



Filter Type	Filter Insert
-------------	---------------

Evaporator, air conditioning

8FV 351 330-111
BEHR HELLA SERVICE

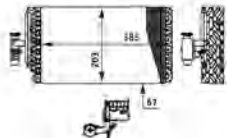

Depth [mm]	67
Length [mm]	385
Supplementary Article/Supplementary Info 2	with expansion valve
Version	produced by BEHR
Width [mm]	203

Spare Parts

	1 x 8UW 351 239-381 Expansion Valve, air conditioning
	1 x 8UW 351 336-161 Expansion Valve, air conditioning

8FV 351 336-111
BEHR HELLA SERVICE

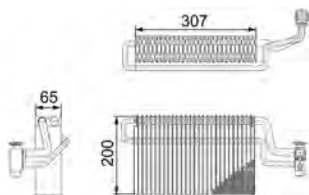

Depth [mm]	65
Length [mm]	307
Supplementary Article/Supplementary Info 2	with expansion valve
Version	produced by BEHR
Width [mm]	200

Spare Parts

	1 x 8UW 351 239-381 Expansion Valve, air conditioning
	1 x 8UW 351 336-161 Expansion Valve, air conditioning

Valve - Expansion Valve, air conditioning

8UW 351 234-041
BEHR HELLA SERVICE

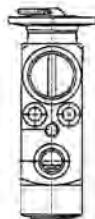

Diameter 1 [mm]	11.1
Diameter 2 [mm]	14
Diameter 3 [mm]	17.2
Diameter 4 [mm]	7.65
Refrigerant	R 134a

8UW 351 239-381
BEHR HELLA SERVICE



Diameter 1 [mm]	18
Diameter 2 [mm]	15
Diameter 3 [mm]	10
Diameter 4 [mm]	12
Refrigerant	R 134a

8UW 351 336-161
BEHR HELLA SERVICE

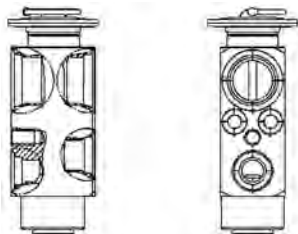

Diameter 1 [mm]	18
Diameter 2 [mm]	18
Diameter 3 [mm]	10
Diameter 4 [mm]	12
for OE number	81.61967.0020
Refrigerant	R 134a



MAN.....412

Manufacturer - Model	Power	Displ.	Year of Constr.	Remark	Part Number	Page
MAN - Cab-over Trucks						07/86→02/90
19.332 U, 19.322 UL, 19.322 ULL	243 kW		07/86→02/90	Diameter 1 [mm]: 11.1; Diameter 2 [mm]: 14; Diameter 3 [mm]: 17.2; Diameter 4 [mm]: 7.65; R 134a	8UW 351 234-041	410
24.332 UNL, 24.332 UNLL	243 kW		10/86→02/90		Expansion Valve, air	
24.362 UNL, 24.362 UNLL	265 kW		10/86→02/90		conditioning	
MAN - E 2000						05/00→
19.310 FALK	228 kW		05/00→	+ OE 81619200017; without dehumidifier	8FC 351 306-061	406
19.310 FALS	228 kW		05/00→		Condenser, air	
19.310 FLK	228 kW		05/00→	Compressor ID: SD7H15; Manufacturer Restriction: Sanden; New Part: 1; Number of Ribs: 2	8FK 351 119-361	401
19.310 FLS	228 kW		05/00→		Compressor, air	
19.360 FALK	265 kW		05/00→			
19.360 FALS	265 kW		05/00→			
19.360 FLK	265 kW		05/00→			
19.360 FLS	265 kW		05/00→			
19.410 FALK	301 kW		05/00→			
19.410 FALS	301 kW		05/00→			
19.410 FLK	301 kW		05/00→			
19.410 FLS	301 kW		05/00→			
19.460 FALK	338 kW		05/00→			
19.460 FALS	338 kW		05/00→			
19.460 FLK	338 kW		05/00→			
19.460 FLS	338 kW		05/00→			
26.310 FAVLC	228 kW		05/00→			
26.310 FAVLK	228 kW		05/00→			
26.360 FAVLC	265 kW		05/00→			
26.360 FAVLK	265 kW		05/00→			
26.410 DFARC	301 kW		05/00→			
26.410 DFRC, FAVLC	301 kW		05/00→			
26.410 FAVLK	301 kW		05/00→			
26.460 DFARC	338 kW		05/00→			
26.460 DFLRS	338 kW		05/00→			
26.460 FAVLC	338 kW		05/00→			
26.460 FAVLK	338 kW		05/00→			
28.310 FNLC	228 kW		05/00→			
28.360 FANLC	265 kW		05/00→			
28.360 FANLK	265 kW		05/00→			
28.360 FANLC	265 kW		05/00→			
28.360 FNLC	265 kW		05/00→			
28.410 FANLC	301 kW		05/00→			
28.410 FANLK	301 kW		05/00→			
28.410 FNLC	301 kW		05/00→			
28.460 FANLC	338 kW		05/00→			
28.460 FANLK	338 kW		05/00→			
28.460 FNLC	338 kW		05/00→			
29.460 FVAS	338 kW		05/00→			
30.310 FNLC	228 kW		05/00→			
30.360 FANLC	265 kW		05/00→			
30.360 FANLK	265 kW		05/00→			
30.360 FNLC	265 kW		05/00→			
30.410 FANLC	301 kW		05/00→			
30.410 FANLK	301 kW		05/00→			
30.410 FNLC	301 kW		05/00→			
30.460 FANLC	338 kW		05/00→			
30.460 FANLK	338 kW		05/00→			
30.460 FNLC	338 kW		05/00→			
32.310 VFCL	228 kW		05/00→			
32.310 VFNLC	228 kW		05/00→			
32.360 VFCL	265 kW		05/00→			
32.360 VFNLC	265 kW		05/00→			
32.410 VFARK	301 kW		05/00→			
32.410 VFCL, VFRC, VFRLC	301 kW		05/00→			
32.410 VFNLC	301 kW		05/00→			
32.460 VFCL, VFRLC	338 kW		05/00→			
32.460 VFNLC	338 kW		05/00→			
33.360 DFAK, DFALK	265 kW		05/00→			
33.360 DFALC	265 kW		05/00→			
33.360 DFALS	265 kW		04/01→			
33.360 DFCL	265 kW		05/00→			
33.360 DFLK	265 kW		05/00→			
33.360 DFSL	265 kW		05/00→			
33.410 DFAK, DFALK	301 kW		05/00→			
33.410 DFALC	301 kW		05/00→			
33.410 DFALS	301 kW		04/01→			
33.410 DFCL	301 kW		05/00→			
33.410 DFLK	301 kW		05/00→			
33.410 DFSL	301 kW		05/00→			
33.460 DFAK, DFALK	338 kW		05/00→			
33.460 DFALC	338 kW		05/00→			
33.460 DFALS	338 kW		04/01→			
33.460 DFCL	338 kW		05/00→			
33.460 DFLK	338 kW		05/00→			

Manufacturer - Model	Power	Displ.	Year of Constr.	Remark	Part Number	Page			
MAN - E 2000						05/00→			
33.460 DFLS	338 kW		05/00→	+ OE 81619200017; without dehumidifier Compressor ID: SD7H15; Manufacturer Restriction: Sanden; New Part: 1; Number of Ribs: 2	8FC 351 306-061 Condenser, air conditioning	406			
35.360 VFAK	265 kW		05/00→						
35.410 FVNLC	301 kW		05/00→						
35.410 VFAK	301 kW		05/00→						
35.460 FVNLC	338 kW		05/00→						
35.460 VFAK	338 kW		05/00→						
41.360 VFAK	265 kW		05/00→						
41.410 VFAK	301 kW		05/00→						
41.460 DFVS, DFVLS	338 kW		06/00→						
41.460 VFAK	338 kW		05/00→						
50.410 VFAK	301 kW		05/00→						
50.410 VFAVK, VFAV-G	301 kW		03/01→						
50.410 VFK	301 kW		05/00→						
50.410 VFKV, VFKV-G	301 kW		10/00→						
50.460 VFAK	338 kW		05/00→						
50.460 VFAVK, VFAV-G	338 kW		03/01→						
50.460 VFK	338 kW		05/00→						
50.460 VFKV, VFKV-G	338 kW		10/00→						
28.230 FNLC	170 kW		05/00→				+ OE 81619200017; without dehumidifier	8FC 351 306-061	406
33.600 DFALS, DFAS	441 kW		06/00→					Condenser, air conditioning	
33.600 DFLS	441 kW		06/00→						
40.600 DFAS	441 kW		06/00→						
41.600 DFVS, DFVLS	441 kW		06/00→						
50.600 VFAS	441 kW		05/00→						
MAN - F 90						07/86→12/97			
19.272 F, 19.272 FL, 19.272 FLL	198 kW		02/90→05/95	Diameter 1 [mm]: 11.1; Diameter 2 [mm]: 14; Diameter 3 [mm]: 17.2; Diameter 4 [mm]: 7.65; R 134a	8UW 351 234-041 Expansion Valve, air conditioning	410			
19.272 FA	198 kW		02/90→05/95						
19.272 FAK	198 kW		02/90→05/95						
19.272 FAS	198 kW		02/90→05/95						
19.272 FS, 19.272 FLS, 19.272 FLLS	198 kW		02/90→05/95						
19.292 F, 19.292 FL, 19.292 FLL	213 kW		07/86→02/90						
19.292 FS, 19.292 FLS, 19.292 FLLS	213 kW		07/86→02/90						
19.322 FA	235 kW		02/90→06/96						
19.322 FAK	235 kW		02/90→06/96						
19.322 FAS	235 kW		02/90→06/96						
19.322 FS, 19.322 FLS, 19.322 FLLS	235 kW		02/90→05/95						
19.332 F, 19.332 FL, 19.332 FLL	243 kW		07/86→02/90						
19.332 FS, 19.332 FLS, 19.332 FLLS	243 kW		07/86→02/90						
19.362 F, 19.362 FL, 19.362 FLL	265 kW		07/86→02/90						
19.362 FS, 19.362 FLS, 19.362 FLLS	265 kW		07/86→02/90						
19.372 F, 19.372 FL, 19.372 FLL	272 kW		02/90→05/95						
19.372 FA	272 kW		02/90→06/96						
19.372 FAK	272 kW		02/90→06/96						
19.372 FAS	272 kW		02/90→06/96						
19.372 FS, 19.372 FLS, 19.372 FLLS	272 kW		02/90→05/95						
19.422 FA	309 kW		02/90→06/96						
19.422 FAK	309 kW		02/90→06/96						
19.422 FAS	309 kW		02/90→06/96						
19.462 F, 19.462 FL	338 kW		05/87→02/90						
19.462 FS, 19.462 FLS	338 kW		05/87→02/90						
24.272 DF	198 kW		02/90→12/90						
24.272 DFS, 24.272 DFLS	198 kW		02/90→04/95						
24.272 FNL, 24.272 FNLL, 24.272 FVL	198 kW		02/90→05/95						
24.272 FNLS, 24.272 FVLS	198 kW		02/90→05/95						
24.292 DF	213 kW		04/87→02/90						
24.292 DFK	213 kW		04/87→02/90						
24.292 DFS, 24.292 DFLS	213 kW		04/87→02/90						
24.292 FNL, 24.292 FNLL, 24.292 FVL	213 kW		10/86→02/90						
24.292 FNLS, 24.292 FVLS	213 kW		10/86→02/90						
24.302 DF	220 kW		05/90→12/90						
24.302 DFK	220 kW		05/90→12/90						
24.302 DFS, 24.302 DFLS	220 kW		05/90→04/95						
24.302 FNL, 24.302 FNLL, 24.302 FVL	220 kW		05/90→10/90						
24.322 DF	235 kW		02/90→12/90						
24.322 FNL, 24.322 FNLL, 24.322 FVL	235 kW		02/90→05/95						
24.322 FNLS, 24.322 FVLS	235 kW		02/90→05/95						
24.332 DF	243 kW		04/87→02/90						
24.332 DFK	243 kW		04/87→02/90						
24.332 DFS, 24.332 DFLS	243 kW		04/87→02/90						

Manufacturer - Model	Power	Displ.	Year of Constr.	Remark	Part Number	Page
MAN - F 90						07/86→12/97
24.332 FNL,24.332 FNLL,24.332 FVL	243 kW		10/86→02/90	Diameter 1 [mm]: 11.1; Diameter 2 [mm]: 14; Diameter 3 [mm]: 17.2; Diameter 4 [mm]: 7.65; R 134a	8UW 351 234-041 Expansion Valve, air conditioning	410
24.332 FNLS,24.332 FVLS	243 kW		10/86→02/90			
24.362 DF	265 kW		04/87→02/90			
24.362 DFK	265 kW		04/87→02/90			
24.362 DFS,24.362 DFLS	265 kW		04/87→02/90			
24.362 FNL,24.362 FNLL,24.362 FVL	265 kW		10/86→02/90			
24.362 FNLS,24.362 FVLS	265 kW		10/86→02/90			
24.372 FNL,24.372 FNLL,24.372 FVL	272 kW		02/90→05/95			
25.272 DF	198 kW		09/90→12/92			
25.272 DFK	198 kW		09/90→12/92			
25.272 DFS,25.272 DFLS	198 kW		09/90→12/92			
25.272 FNL,25.272 FNLL,25.272 FVL	198 kW		09/90→10/93			
25.302 DF	220 kW		09/90→12/91			
25.302 DFK	220 kW		09/90→12/91			
25.302 DFS, 25.302 DFLS	220 kW		09/90→12/91			
25.302 FNL, 25.302 FNLL, 25.302 FVL	220 kW		09/90→12/91			
25.302 FNLS, 25.302 FVLS	220 kW		09/90→12/91			
25.322 DF, 25.322 DFL	235 kW		09/90→12/92			
25.322 DFK	235 kW		09/90→12/92			
25.322 DFS, 25.322 DFLS	235 kW		09/90→12/92			
25.322 FNL, 25.322 FNLL, 25.322 FVL	235 kW		09/90→12/92			
25.322 FNLS,25.322 FVLS	235 kW		09/90→12/92			
25.372 DF	272 kW		09/90→12/92			
25.372 DFK	272 kW		09/90→12/92			
25.372 DFS,25.372 DFLS	272 kW		09/90→12/92			
25.372 FNL, 25.372 FNLL, 25.372 FVL	272 kW		09/90→12/92			
25.372 FNLS,25.372 FVLS	272 kW		09/90→10/93			
25.422 DF	309 kW		09/90→12/92			
25.422 DFS,25.422 DFLS	309 kW		09/90→12/92			
25.422 FNL,25.422 FNLL	309 kW		09/90→12/92			
25.422 FNLS,25.422 FVLS	309 kW		09/90→12/92			
26.272 DF	198 kW		02/90→06/96			
26.272 DFA	198 kW		02/90→12/92			
26.272 DFAK	198 kW		02/90→12/92			
26.272 DFAS	198 kW		02/90→12/92			
26.272 DFK	198 kW		02/90→06/96			
26.272 DFS,26.272 DFLS	198 kW		02/90→06/96			
26.272 FNL,26.272 FNLL	198 kW		03/91→05/95			
26.272 FNLS,26.272 FVLS	198 kW		09/90→12/95			
26.292 DFA	213 kW		05/88→02/90			
26.292 DFAK	213 kW		05/88→02/90			
26.292 DFAS	213 kW		05/88→02/90			
26.302 DFA	220 kW		05/90→12/91			
26.302 DFAK	220 kW		05/90→12/91			
26.302 DFAS	220 kW		05/90→12/91			
26.302 FNL, 26.302 FNLL, 26.302 FVL	220 kW		03/91→12/91			
26.302 FNLS,26.302 FVLS	220 kW		09/90→12/91			
26.322 DF	235 kW		02/90→06/96			
26.322 DFA	235 kW		02/90→12/92			
26.322 DFAK	235 kW		02/90→12/92			
26.322 DFAS	235 kW		02/90→12/92			
26.322 DFK	235 kW		02/92→06/96			
26.322 DFS,26.322 DFLS	235 kW		02/90→06/96			
26.322 FNL,26.322 FNLL	235 kW		03/91→05/95			
26.322 FNLS,26.322 FVLS	235 kW		09/90→12/95			
26.332 DFA	243 kW		05/88→02/90			
26.332 DFAK	243 kW		05/88→02/90			
26.332 DFAS	243 kW		05/88→02/90			
26.372 DF,26.372 DFL	272 kW		02/90→06/96			
26.372 DFA	272 kW		02/90→12/92			
26.372 DFAK	272 kW		01/92→06/96			
26.372 DFAS	272 kW		02/90→12/92			
26.372 DFK	272 kW		01/92→06/96			
26.372 DFS	272 kW		02/90→06/96			
26.372 FNL,26.372 FNLL,26.372 FVL	272 kW		09/90→12/95			
26.372 FNLS,26.372 FVLS	272 kW		01/92→06/96			
26.422 DF,26.422 DFL	309 kW		02/90→06/96			
26.422 DFA	309 kW		02/90→12/92			
26.422 DFAK	309 kW		02/90→12/92			
26.422 DFAS	309 kW		02/90→12/92			
26.422 DFK	309 kW		02/90→12/95			
26.422 DFS	309 kW		02/90→12/95			

Manufacturer - Model	Power	Displ.	Year of Constr.	Remark	Part Number	Page
MAN - F 90						07/86→12/97
26.422 FNL,26.422 FNLL,26.422 FVL	309 kW		09/90→12/95	Diameter 1 [mm]: 11.1; Diameter 2 [mm]: 14; Diameter 3 [mm]: 17.2; Diameter 4 [mm]: 7.65; R 134a	8UW 351 234-041 Expansion Valve, air conditioning	410
32.272 VF	198 kW		02/90→04/95			
32.272 VFK	198 kW		02/90→04/95			
32.302 VF	220 kW		05/90→09/91			
32.302 VFK	220 kW		05/90→09/91			
32.322 VF	235 kW		02/90→06/96			
32.322 VFK	235 kW		02/90→06/96			
32.372 VF	249 kW		02/90→06/96			
32.372 VFK	272 kW		02/90→06/96			
32.372 VFK	249 kW		05/90→04/95			
32.372 VFK	272 kW		02/90→06/96			
32.422 VF	309 kW		02/90→06/96			
33.272 DF	198 kW		10/92→04/95			
33.272 DFA	198 kW		10/92→04/95			
33.292 DFK	213 kW		09/87→02/90			
33.292 DFS	213 kW		09/87→02/90			
33.322 DF	235 kW		09/91→06/96			
33.322 DFA	235 kW		09/91→06/96			
33.372 DF	272 kW		09/91→06/96			
33.372 DFA	272 kW		09/91→06/96			
33.372 DFAK	272 kW		01/91→06/96			
33.372 DFK	272 kW		01/91→06/96			
33.372 DFS	272 kW		09/91→06/96			
33.422 DFA	309 kW		09/91→06/96			
33.422 DFAK	309 kW		01/94→06/96			
35.302 VF	220 kW		05/90→09/91			
35.302 VFK	220 kW		05/90→09/91			
35.322 VFK	235 kW		02/90→06/96			
35.322 VK	235 kW		02/90→06/96			
35.372 VF	272 kW		02/90→06/96			
35.372 VFK	272 kW		02/90→06/96			
35.422 VF	309 kW		02/90→06/96			
35.422 VF	309 kW		02/90→12/97			
35.422 VFK	309 kW		02/90→06/96			
35.422 VFK	309 kW		02/90→12/97			
40.372 DF	272 kW		12/91→06/96			
40.372 DFA	272 kW		12/91→06/96			
40.422 DF	309 kW		12/91→06/96			
40.422 DFA	309 kW		12/91→06/96			
41.272 VF	198 kW		02/90→12/91			
41.322 VF	235 kW		02/90→06/96			
41.372 VF	272 kW		02/90→06/96			
41.422 VF	309 kW		02/90→06/96			
MAN - F 2000						01/94→
19.233 FCNG	170 kW		09/96→	+ OE 81619200012; Depth [mm]: 33; L 678 mm; without dehumidifier; Vers. produced by BEHR; W 304 mm	8FC 351 300-061 Condenser, air conditioning	404
26.233 FVL CNG	170 kW					
19.233 FKNG	170 kW		03/00→	Depth [mm]: 33; L 678 mm; without dehumidifier; Vers. produced by BEHR; W 304 mm	8FC 351 300-061 Condenser, air conditioning	404
26.233 FVL-KO	170 kW					
27.314 FVL	228 kW		06/98→	+ OE 81619200017; without dehumidifier	8FC 351 306-061 Condenser, air conditioning	406
27.364 FVL	265 kW		06/98→			
27.414 FVL	301 kW		06/98→			
27.464 FVL	338 kW		06/98→			
37.414 VFA	301 kW		06/98→			
37.464 VFA	338 kW		06/98→			
19.273 F, FL, FLL	198 kW		01/94→			
19.273 FA	198 kW		01/94→			
19.273 FAK	198 kW		01/94→	+ OE 81619200017; without dehumidifier	8FC 351 306-061 Condenser, air conditioning	406
19.273 FK	198 kW		01/94→			
19.273 FS,19.273 FLS	198 kW		01/94→12/95			
19.314 FAS	228 kW		06/98→			
19.314 FK, FLK, F-KI, FL-KI	228 kW		06/98→			
19.314 FS, FLS, FLLS, FRS, FLRS, FLLRS	228 kW		06/98→			
19.364 FAC	265 kW		06/98→			
19.364 FAK, FA-KI	265 kW		06/98→			
19.364 FAS	265 kW		06/98→			
19.364 FK, FLK, F-KI, FL-KI	265 kW		06/98→			
19.364 FS, FLS, FLLS, FRS, FLRS, FLLRS	265 kW		06/98→			
19.373 FAC	272 kW		01/94→	Compressor ID: SD7H15; Manufacturer Restriction: Sanden; New Part: 1; Number of Ribs: 2	8FK 351 126-201 Compressor, air conditioning	401
19.373 FAK, FA-KI	272 kW		01/94→			
19.373 FAS	272 kW		01/94→			
19.373 FK, FLK, F-KI, FL-KI	272 kW		01/94→			

Manufacturer - Model	Power	Displ.	Year of Constr.	Remark	Part Number	Page
MAN - F 2000						01/94→
19.373 FS, FLS, FLLS, FRS, FLRS, FLLRS	272 kW		01/94→	+ OE 81619200012; Depth [mm]: 33; L 678 mm; without dehumidifier; Vers. produced by BEHR; W 304 mm	8FC 351 300-061	404
19.414 FAC	301 kW		06/98→		Condenser, air conditioning	
19.414 FAK, FA-KI	301 kW		06/98→	+ OE 81619200017; without dehumidifier	8FC 351 306-061	406
19.414 FAS	301 kW		06/98→		Condenser, air conditioning	
19.414 FK, FLK, F-KI, FL-KI	301 kW		06/98→	Compressor ID: SD7H15; Manufacturer Restriction: Sanden; New Part: 1; Number of Ribs: 2	8FK 351 126-201	401
19.414 FS, FLS, FLLS, FRS, FLRS, FLLRS	301 kW		06/98→		Compressor, air conditioning	
19.423 FAC	309 kW		01/94→12/95			
19.423 FAK, FA-KI	309 kW		01/94→			
19.423 FAS	309 kW		01/94→12/95			
19.423 FK, FLK, F-KI, FL-KI	309 kW		01/94→			
19.423 FS, FLS, FLLS	309 kW		01/94→			
24.273 FNLLC	198 kW		01/94→12/95			
24.373 FNLLC	272 kW		01/94→12/95			
24.423 FNLLC	309 kW		01/94→12/95			
26.273 DFC,26.273 DFLC	198 kW		01/94→12/95			
26.273 DFK,26.273 DFLK	198 kW		01/94→12/95			
26.273 DFS,26.273 DFSL	198 kW		01/94→12/95			
26.273 FNLC,26.273 FNLLC,	198 kW		01/94→12/95			
26.273 FVLC						
26.273 FNLS,26.273 FVLS	198 kW		01/94→12/95			
26.373 DFC,26.373 DFLC	272 kW		01/94→12/95			
26.373 DFK,26.373 DFLK	272 kW		01/94→12/95			
26.373 DFS,26.373 DFSL	272 kW		01/94→12/95			
26.373 FNLS,26.373 FVLS	272 kW		01/94→12/95			
26.423 DFC,26.423 DFLC	309 kW		01/94→12/95			
26.423 DFK,26.423 DFLK	309 kW		01/94→12/95			
26.423 DFS,26.423 DFSL	309 kW		01/94→12/95			
26.423 FNLS,26.423 FVLS	309 kW		01/94→12/95			
27.273 DFAC	198 kW		01/94→12/95			
27.273 DFAK	198 kW		01/94→12/95			
27.273 DFAS	198 kW		01/94→12/95			
27.273 DFC	198 kW		01/94→12/95			
27.273 DFK	198 kW		01/94→12/95			
27.273 DFS	198 kW		01/94→12/95			
27.373 DFAC	272 kW		01/94→			
27.373 DFAK, DFA-KI	272 kW		01/94→			
27.373 DFAS	272 kW		01/94→			
27.373 DFC	272 kW		01/94→			
27.373 DFK, DF-KI	272 kW		01/94→			
27.373 DFS	272 kW		01/94→			
27.423 DFAC	309 kW		01/94→			
27.423 DFAK, DFA-KI	309 kW		01/94→			
27.423 DFAS	309 kW		01/94→12/95			
27.423 DFC	309 kW		01/94→			
27.423 DFK, DF-KI	309 kW		01/94→			
27.423 DFS	309 kW		01/94→			
33.323 DFAC	235 kW		01/94→12/95			
33.323 DFAK	235 kW		01/94→12/95			
33.323 DFAS	235 kW		01/94→12/95			
33.323 DFC	235 kW		01/94→12/95			
33.323 DFK	235 kW		01/94→12/95			
33.323 DFS	235 kW		01/94→12/95			
33.373 DFAC	272 kW		01/94→			
33.373 DFAK, DFA-KI	272 kW		01/94→			
33.373 DFAS	272 kW		01/94→			
33.373 DFC	272 kW		01/94→			
33.373 DFK, DF-KI	272 kW		01/94→			
33.373 DFS, DFRS	272 kW		01/94→			
33.423 DFAC	309 kW		01/94→			
33.423 DFAK, DFA-KI	309 kW		01/94→			
33.423 DFAS	309 kW		01/94→			
33.423 DFC	309 kW		01/94→			
33.423 DFK, DF-KI	309 kW		01/94→			
33.423 DFS, DFRS	309 kW		01/94→			
19.293 FAC	213 kW		01/94→	Depth [mm]: 33; L 678 mm; without dehumidifier; Vers. produced by BEHR; W 304 mm	8FC 351 300-061	404
19.293 FAK	213 kW		01/94→		Condenser, air conditioning	
19.293 FAS	213 kW		01/94→	+ OE 81619200017; without dehumidifier	8FC 351 306-061	406
19.293 FC,19.293 FLC,19.293 FLLC	213 kW		01/94→		Condenser, air conditioning	
19.293 FK,19.293 FLK	213 kW		01/94→	Compressor ID: SD7H15; Manufacturer Restriction: Sanden; New Part: 1; Number of Ribs: 2	8FK 351 126-201	401
19.293 FS,19.293 FLS,19.293 FLLS	213 kW		01/94→		Compressor, air conditioning	
19.323 FAC	235 kW		01/94→12/95			
19.323 FAK	235 kW		01/94→12/95			
19.323 FAS	235 kW		01/94→12/95	Diameter 1 [mm]: 11.1; Diameter 2 [mm]: 14; Diameter 3 [mm]: 17.2; Diameter 4 [mm]: 7.65; R 134a	8UW 351 234-041	410
19.323 FC,19.323 FLC,19.323 FLLC	235 kW		01/94→12/95		Expansion Valve, air conditioning	
19.323 FK,19.323 FLK	235 kW		01/94→12/95			

Manufacturer - Model	Power	Displ.	Year of Constr.	Remark	Part Number	Page
MAN - F 2000						01/94→
19.323 FS,19.323 FLS,19.323 FLLS	235 kW		01/94→12/95	Depth [mm]: 33; L 678 mm; without dehumidifier; Vers. produced by BEHR; W 304 mm	8FC 351 300-061	404
19.343 FAC	250 kW		01/94→		Condenser, air conditioning	
19.343 FAK	250 kW		01/94→	+ OE 81619200017; without dehumidifier	8FC 351 306-061	406
19.343 FAS	250 kW		01/94→		Condenser, air conditioning	
19.343 FC,19.343 FLC,19.343 FLLC	250 kW		01/94→	Compressor ID: SD7H15; Manufacturer Restriction: Sanden; New Part: 1; Number of Ribs: 2	8FK 351 126-201	401
19.343 FK,19.343 FLK	250 kW		01/94→		Compressor, air conditioning	
19.343 FS,19.343 FLS,19.343 FLLS	250 kW		01/94→	Diameter 1 [mm]: 11.1; Diameter 2 [mm]: 14; Diameter 3 [mm]: 17.2; Diameter 4 [mm]: 7.65; R 134a	8UW 351 234-041	410
19.603 FLS, 19604 FLS	441 kW		04/96→		Expansion Valve, air conditioning	
23.293 FNLLC	213 kW		01/94→			
23.343 FNLLC	250 kW		01/94→			
24.293 FNLLC	213 kW		01/94→			
24.323 FNLLC	235 kW		01/94→12/95			
24.343 FNLLC	250 kW		01/94→			
26.293 DFC,26.293 DFCL	213 kW		01/94→			
26.293 DFK,26.293 DFLK	213 kW		01/94→			
26.293 DFS,26.293 DFSL	213 kW		01/94→			
26.293 FNLC,26.293 FNLLC,	213 kW		01/94→			
26.293 FVLC						
26.293 FNLS,26.293 FVLS	213 kW		01/94→			
26.323 DFC,26.323 DFCL	235 kW		01/94→12/95			
26.323 DFK,26.323 DFLK	235 kW		01/94→12/95			
26.323 DFS,26.323 DFSL	235 kW		01/94→12/95			
26.323 FNLC,26.323 FNLLC,	235 kW		01/94→12/95			
26.323 FVLC						
26.323 FNLS,26.323 FVLS	235 kW		01/94→12/95			
26.343 DFC,26.343 DFCL	250 kW		01/94→			
26.343 DFK,26.343 DFLK	250 kW		01/94→			
26.343 DFS,26.343 DFSL	250 kW		01/94→			
26.343 FNLC,26.343 FNLLC,	250 kW		01/94→			
26.343 FVLC						
26.343 FNLS,26.343 FVLS	250 kW		01/94→			
26.603 DFC, DFCL	441 kW		06/96→			
26.603 DFK, DFLK	441 kW		06/96→			
26.603 DFS, DFSL	441 kW		06/96→			
26.604 DFSL	441 kW		04/00→			
27.293 DFAC	213 kW		01/94→			
27.293 DFAK	213 kW		01/94→			
27.293 DFAS	213 kW		01/94→			
27.293 DFC	213 kW		01/94→			
27.293 DFK	213 kW		01/94→			
27.293 DFS	213 kW		01/94→			
27.323 DFAC	235 kW		01/94→12/95			
27.323 DFAK, DFA-KI	235 kW		01/94→			
27.323 DFAS	235 kW		01/94→12/95			
27.323 DFC	235 kW		01/94→12/95			
27.323 DFK, DF-KI	235 kW		01/94→			
27.323 DFS	235 kW		01/94→12/95			
27.343 DFAC	250 kW		01/94→			
27.343 DFAK	250 kW		01/94→			
27.343 DFAS	250 kW		01/94→			
27.343 DFC	250 kW		01/94→			
27.343 DFK	250 kW		01/94→			
27.343 DFS	250 kW		01/94→			
27.603 DFAS	441 kW		01/96→			
27.603 DFS	441 kW		01/96→			
32.293 VFC	213 kW		08/95→			
32.343 VFC	250 kW		08/95→			
32.343 VFK	250 kW		08/95→			
33.343 DFAC	250 kW		01/94→			
33.343 DFAK	250 kW		01/94→			
33.343 DFAS	250 kW		01/94→			
33.343 DFC	250 kW		01/94→			
33.343 DFK	250 kW		01/94→			
33.343 DFS	250 kW		01/94→			
33.603 DFAC	441 kW		06/96→			
33.603 DFAS	441 kW		06/96→			
33.603 DFC	441 kW		06/96→			
33.603 DFS	441 kW		06/96→			
35.343 VFC	250 kW		08/95→			
35.343 VFK	250 kW		08/95→			
41.343 VFC	250 kW		08/95→			
41.343 VFK	250 kW		08/95→			
19.314 FAC	228 kW		05/01→	+ OE 81619200012; Depth [mm]: 33; L 678 mm; without dehumidifier; Vers. produced by BEHR; W 304 mm	8FC 351 300-061	404
19.314 FAK, FA-KI	228 kW		05/01→		Condenser, air conditioning	
19.314 FC, FLC, FLLC, FLLW, FRC, FLRC, FLLRC, FLL, FLLR, F-N	228 kW		06/98→	+ OE 81619200017; without dehumidifier	8FC 351 306-061	406
					Condenser, air conditioning	

Manufacturer - Model	Power	Displ.	Year of Constr.	Remark	Part Number	Page
MAN - F 2000						01/94→
19.364 FC, FLC, FLLC, FLLW, FRC, FLRC, FLLRC, FLL, FLLR, F-N	265 kW		06/98→	Compressor ID: SD7H15; Manufacturer Restriction: Sanden; New Part: 1; Number of Ribs: 2	8FK 351 119-361 Compressor, air conditioning	401
19.373 FC, FLC, FLLC, FRC, FLRC, F-NL	272 kW		01/94→	Compressor ID: SD7H15; Manufacturer Restriction: Sanden; New Part: 1; Number of Ribs: 2	8FK 351 126-201 Compressor, air conditioning	401
19.414 FC, FLC, FLLC, FRC, FLRC, FLLRC, FLL, FLLR, F-NL	301 kW		06/98→			
19.423 FC, FLC, FLLC, F-NL	309 kW		01/94→			
23.314 FNLLC	228 kW		05/01→			
23.364 FNLLC	265 kW		05/01→			
23.414 FNLLC	301 kW		05/01→			
24.314 FNLLRC	228 kW		05/01→			
24.364 FNLLRC	265 kW		05/01→			
24.414 FNLLRC	301 kW		05/01→			
26.314 DFC, DFCL	228 kW		05/01→			
26.314 DFK, DFLK	228 kW		05/01→			
26.314 DFS, DFSL	228 kW		05/01→			
26.314 DF-TM	228 kW		05/01→			
26.314 FNLC, FNLLC, FNLLRC, FNLLW, FVLC	228 kW		05/01→			
26.314 FNLS	228 kW		05/01→			
26.314 FVL-KO	228 kW		05/01→			
26.314 FVLS, FVLRS	228 kW		05/01→			
26.364 DFC, DFCL	265 kW		05/01→			
26.364 DFK, DFLK	265 kW		05/01→			
26.364 DFS, DFSL	265 kW		05/01→			
26.364 DF-TM	265 kW		05/01→			
26.364 FNLC, FNLLC, FNLLRC, FNLLW, FVLC	265 kW		05/01→			
26.364 FNLS	265 kW		05/01→			
26.364 FVL-KO	265 kW		05/01→			
26.364 FVLS, FVLRS	265 kW		05/01→			
26.414 DFC, DFCL	301 kW		05/01→			
26.414 DFK, DFLK	301 kW		05/01→			
26.414 DFS, DFSL	301 kW		05/01→			
26.414 DF-TM	301 kW		05/01→			
26.414 FNLC, FNLLC, FNLLRC, FNLLW, FVLC	301 kW		05/01→			
26.414 FNLS	301 kW		05/01→			
26.414 FVL-KO	301 kW		05/01→			
26.414 FVLS, FVLRS	301 kW		05/01→			
27.314 DFAC	228 kW		05/01→			
27.314 DFAK, DFA-KI	228 kW		05/01→			
27.314 DFAS	228 kW		05/01→			
27.314 DFC	228 kW		05/01→			
27.314 DFK, DF-KI	228 kW		05/01→			
27.314 DFS	228 kW		05/01→			
27.314 DF-TM	228 kW		05/01→			
27.364 DFAC	265 kW		05/01→			
27.364 DFAK, DFA-KI	265 kW		05/01→			
27.364 DFAS	265 kW		05/01→			
27.364 DFC	265 kW		05/01→			
27.364 DFK, DF-KI	265 kW		05/01→			
27.364 DFS	265 kW		05/01→			
27.364 DF-TM	265 kW		05/01→			
27.373 DF-TM	272 kW		07/00→			
27.414 DFAC	301 kW		05/01→			
27.414 DFAK, DFA-KI	301 kW		05/01→			
27.414 DFAS	301 kW		05/01→			
27.414 DFC	301 kW		05/01→			
27.414 DFK, DF-KI	301 kW		05/01→			
27.414 DFS	301 kW		05/01→			
27.414 DF-TM	301 kW		05/01→			
27.423 DF-TM	309 kW		07/00→			
32.314 VF, VFC	228 kW		05/01→			
32.314 VFK, VF-HK	228 kW		05/01→			
32.314 VF-TM	228 kW		05/01→			
32.364 VF, VFC	265 kW		05/01→			
32.364 VFK, VF-HK	265 kW		05/01→			
32.364 VF-TM	265 kW		05/01→			
32.414 VF, VFC	301 kW		05/01→			
32.414 VFK, VF-HK	301 kW		05/01→			
32.414 VF-TM	301 kW		05/01→			
33.364 DFAC	265 kW		05/01→			
33.364 DFAK, DFA-KI	265 kW		05/01→			
33.364 DFAS	265 kW		05/01→			
33.364 DFC	265 kW		05/01→			
33.364 DFK, DF-KI	265 kW		05/01→			
33.364 DFS, DFSL	265 kW		05/01→			
33.414 DFAC	301 kW		05/01→			
33.414 DFAK, DFA-KI	301 kW		05/01→			

Manufacturer - Model	Power	Displ.	Year of Constr.	Remark	Part Number	Page
MAN - F 2000						01/94→
33.414 DFAS	301 kW		05/01→			
33.414 DFC	301 kW		05/01→			
33.414 DFK, DF-KI	301 kW		05/01→			
33.414 DFS, DFRS	301 kW		05/01→			
35.314 VF-TM	228 kW		03/02→			
35.364 VF, VFC, VFRC	265 kW		05/01→			
35.364 VFK, VF-HK, VF-KI	265 kW		03/02→			
35.364 VF-TM	265 kW		03/02→			
35.373 VF, VFC, VFRC	272 kW		05/01→			
35.373 VFK, VF-HK, VF-KI	272 kW		03/02→			
35.414 VF, VFC, VFRC	301 kW		05/01→			
35.414 VFK, VF-HK, VF-KI	301 kW		03/02→			
35.414 VF-TM	301 kW		03/02→			
35.423 VF, VFC	309 kW		05/01→			
35.423 VFK, VF-HK, VF-KI	309 kW		03/02→			
40.373 DFAK	272 kW		05/01→			
40.373 DFK	272 kW		05/01→			
40.414 DFAK	301 kW		05/01→			
40.414 DFK	301 kW		05/01→			
40.423 DFAK	309 kW		05/01→			
40.423 DFK	309 kW		05/01→			
41.364 VF, VFC, VFRC	265 kW		05/01→			
41.364 VFK, VF-HK, VF-KI	265 kW		03/02→			
41.373 VF, VFC, VFRC	272 kW		05/01→			
41.373 VFK, VF-HK, VF-KI	272 kW		03/02→			
41.414 VF, VFC, VFRC	301 kW		05/01→			
41.414 VFK, VF-HK, VF-KI	301 kW		03/02→			
41.423 VF, VFC, VFRC	309 kW		05/01→			
41.423 VFK, VF-HK, VF-KI	309 kW		03/02→			
19.403 FAC	294 kW		01/94→	Depth [mm]: 33; L 678 mm; without dehumidifier; Vers. produced by BEHR; W 304 mm	8FC 351 300-061	404
19.403 FAK, FA-KI	294 kW		01/94→		Condenser, air conditioning	
19.403 FAS	294 kW		01/94→	+ OE 81619200017; without dehumidifier	8FC 351 306-061	406
19.403 FC, FLC, FLLC, FRC, FLRC, F-NL	294 kW		01/94→		Condenser, air conditioning	
19.403 FK, FLK, F-KI, FL-KI	294 kW		01/94→	Compressor ID: SD7H15; Manufacturer Restriction: Sanden; New Part: 1; Number of Ribs: 2	8FK 351 119-361	401
19.403 FS, FLS, FLLS, FRS, FLRS, FLLRS	294 kW		01/94→		Compressor, air conditioning	
23.403 FNLLC	294 kW		01/94→	Compressor ID: SD7H15; Manufacturer Restriction: Sanden; New Part: 1; Number of Ribs: 2	8FK 351 126-201	401
24.403 FNLLC	294 kW		01/94→		Compressor, air conditioning	
26.403 DFC,26.403 DFLC	294 kW		01/94→	Diameter 1 [mm]: 11.1; Diameter 2 [mm]: 14; Diameter 3 [mm]: 17.2; Diameter 4 [mm]: 7.65; R 134a	8UW 351 234-041	410
26.403 DFK,26.403 DFLK	294 kW		01/94→		Expansion Valve, air conditioning	
26.403 DFS,26.403 DFLS	294 kW		01/94→			
26.403 FNLC,26.403 FNLLC, 26.403 FVLC	294 kW		01/94→			
26.403 FNLS,26.403 FVLS	294 kW		01/94→			
27.403 DFAC	294 kW		01/94→			
27.403 DFAK, DFA-KI	294 kW		01/94→			
27.403 DFAS	294 kW		01/94→			
27.403 DFC	294 kW		01/94→			
27.403 DFK, DF-KI	294 kW		01/94→			
27.403 DFS	294 kW		01/94→			
27.403 DF-TM	294 kW		07/00→			
32.403 VFC	294 kW		08/95→			
32.403 VFK	294 kW		08/95→			
33.403 DFAC	294 kW		01/94→			
33.403 DFAK, DFA-KI	294 kW		01/94→			
33.403 DFAS	294 kW		01/94→			
33.403 DFC	294 kW		01/94→			
33.403 DFK, DF-KI	294 kW		01/94→			
33.403 DFS, DFRS	294 kW		01/94→			
35.403 VF, VFC, VFRC	294 kW		08/95→			
35.403 VFK, VF-HK, VF-KI	294 kW		03/02→			
40.403 DFAK	294 kW		01/94→			
40.403 DFK	294 kW		01/94→			
41.403 VF, VFC, VFRC	294 kW		08/95→			
41.403 VFK, VF-HK, VF-KI	294 kW		08/95→			
19.463 FAC	338 kW		01/94→	Depth [mm]: 33; L 678 mm; without dehumidifier; Vers. produced by BEHR; W 304 mm	8FC 351 300-061	404
19.463 FAK, FA-KI	338 kW		01/94→		Condenser, air conditioning	
19.463 FAS	338 kW		01/94→	+ OE 81619200017; without dehumidifier	8FC 351 306-061	406
19.463 FC, FLC, FLLC, FRC, FLRC, F-NL	338 kW		01/94→		Condenser, air conditioning	
19.463 FK, FLK, F-KI, FL-KI	338 kW		01/94→	+ OE 51779707011 / + OE 51779707014; Compressor ID: SD7H15; Manufacturer Restriction: Sanden; New Part: 1; Number of Ribs: 2	8FK 351 119-361	401
19.463 FS, FLS, FLLS, FRS, FLRS, FLLRS	338 kW		01/94→		Compressor, air conditioning	
19.464 FAC	338 kW		06/98→	Compressor ID: SD7H15; Manufacturer Restriction: Sanden; New Part: 1; Number of Ribs: 2	8FK 351 126-201	401
23.463 FNLLC	338 kW		01/94→		Compressor, air conditioning	
23.464 FNLLC	338 kW		05/01→			
24.464 FNLLRC	338 kW		05/01→			
26.463 DFC, DFLC	338 kW		01/94→			
26.463 DFK,26.463 DFLK	338 kW		01/94→			
26.463 DFS,26.463 DFLS	338 kW		01/94→			

Manufacturer - Model	Power	Displ.	Year of Constr.	Remark	Part Number	Page
MAN - F 2000						01/94→
26.463 FNLC, FNLLC, FVLC	338 kW		01/94→	Diameter 1 [mm]: 11.1; Diameter 2 [mm]: 14; Diameter 3 [mm]: 17.2; Diameter 4 [mm]: 7.65; R 134a	8UW 351 234-041 Expansion Valve, air conditioning	410
26.463 FNLS, 26.463 FVLS	338 kW		01/94→			
26.464 DFC, DFLC	338 kW		05/01→			
26.464 DFK, DFLK	338 kW		05/01→			
26.464 DFS, DFSL	338 kW		05/01→			
26.464 DF-TM	338 kW		05/01→			
26.464 FNLC, FNLLC, FNLLW, FVLC	338 kW		05/01→			
26.464 FNLS	338 kW		05/01→			
26.464 FVL-KO	338 kW		05/01→			
26.464 FVLS, FVLRS	338 kW		05/01→			
27.463 DFAC	338 kW		01/94→			
27.463 DFAK, DFA-KI	338 kW		01/94→			
27.463 DFAS	338 kW		01/94→			
27.463 DFC	338 kW		01/94→			
27.463 DFK, DF-KI	338 kW		01/94→			
27.463 DFS	338 kW		01/94→			
27.463 DF-TM	338 kW		07/00→			
27.464 DFAC	338 kW		05/01→			
27.464 DFAK, DFA-KI	338 kW		05/01→			
27.464 DFAS	338 kW		05/01→			
27.464 DFC	338 kW		01/94→			
27.464 DFK, DF-KI	338 kW		05/01→			
27.464 DFS	338 kW		01/94→			
27.464 DF-TM	338 kW		05/01→			
32.463 VFC	338 kW		08/95→			
32.463 VFK	338 kW		08/95→			
32.464 VF, VFC	338 kW		05/01→			
32.464 VFK, VF-HK	338 kW		05/01→			
32.464 VF-TM	338 kW		05/01→			
33.463 DFAC	338 kW		01/94→			
33.463 DFAK, DFA-KI	338 kW		01/94→			
33.463 DFAS	338 kW		01/94→			
33.463 DFC	338 kW		01/94→			
33.463 DFK, DF-KI	338 kW		01/94→			
33.463 DFS, DFRS	338 kW		01/94→			
33.464 DFAC	338 kW		05/01→			
33.464 DFAK, DFA-KI	338 kW		05/01→			
33.464 DFAS	338 kW		05/01→			
33.464 DFC	338 kW		05/01→			
33.464 DFK, DF-KI	338 kW		05/01→			
33.464 DFS, DFRS	338 kW		05/01→			
35.463 VF, VFC, VFRC	338 kW		08/95→			
35.463 VFK, VF-HK, VF-KI	338 kW		08/95→			
35.464 VF, VFC, VFRC	338 kW		05/01→			
35.464 VFK, VF-HK, VF-KI	338 kW		03/02→			
35.464 VF-TM	338 kW		03/02→			
41.463 VFK, VF-HK, VF-KI	338 kW		08/95→			
41.464 VF, VFC, VFRC	338 kW		06/98→			
41.464 VFK, VF-HK, VF-KI	338 kW		03/02→			
19.464 FAK, FA-KI	338 kW		06/98→	+ OE 81619200012; Depth [mm]: 33; L 678 mm; without dehumidifier; Vers. produced by BEHR; W 304 mm 8FC 351 300-061 404 Condenser, air conditioning + OE 81619200017; without dehumidifier 8FC 351 306-061 406 Condenser, air conditioning + OE 51779707011 / + OE 51779707014; Compressor ID: SD7H15; Manufacturer Restriction: Sanden; New Part: 1; Number of Ribs: 2 8FK 351 119-361 401 Compressor, air conditioning Compressor ID: SD7H15; Manufacturer Restriction: Sanden; New Part: 1; Number of Ribs: 2 8FK 351 126-201 401 Compressor, air conditioning		
19.464 FAS	338 kW		06/98→			
19.464 FC, FLC, FLLC, FLL, FRC, FLLR, FLLRC, FLLW, F-NL	338 kW		06/98→			
19.464 FK, FLK, F-KI, FL-KI	338 kW		06/98→			
19.464 FS, FLS, FLLS, FRS, FLRS, FLLRS	338 kW		06/98→			
24.463 FNLLC	338 kW		01/94→	Depth [mm]: 33; L 678 mm; without dehumidifier; Vers. produced by BEHR; W 304 mm 8FC 351 300-061 404 Condenser, air conditioning + OE 81619200017; without dehumidifier 8FC 351 306-061 406 Condenser, air conditioning + OE 51779707011 / + OE 51779707014; Compressor ID: SD7H15; Manufacturer Restriction: Sanden; New Part: 1; Number of Ribs: 2 8FK 351 119-361 401 Compressor, air conditioning Compressor ID: SD7H15; Manufacturer Restriction: Sanden; New Part: 1; Number of Ribs: 2 8FK 351 126-201 401 Compressor, air conditioning		

Manufacturer - Model	Power	Displ.	Year of Constr.	Remark	Part Number	Page
MAN - F 2000						01/94→
26.373 FNLC,26.373 FNLLC, 26.373 FVLC	272 kW		01/94→12/95	Depth [mm]: 33; L 678 mm; without dehumidifier; Vers. produced by BEHR; W 304 mm + OE 81619200017; without dehumidifier Compressor ID: SD7H15; Manufacturer Restriction: Sanden; New Part: 1; Number of Ribs: 2	8FC 351 300-061 Condenser, air conditioning	404
26.423 FNLC,26.423 FNLLC, 26.423 FVLC	309 kW		01/94→12/95		8FC 351 306-061 Condenser, air conditioning	406
					8FK 351 126-201 Compressor, air conditioning	401
40.273 DFAK 40.273 DFK 40.463 DFAK 40.463 DFAS 40.463 DFK	198 kW 198 kW 338 kW 338 kW 338 kW		01/94→ 01/94→ 01/94→ 01/94→ 01/94→	+ OE 81619200017; without dehumidifier	8FC 351 306-061 Condenser, air conditioning	406
41.463 VF, VFC, VFRC	338 kW		08/95→	Depth [mm]: 33; L 678 mm; without dehumidifier; Vers. produced by BEHR; W 304 mm + OE 51779707011 / + OE 51779707014; Compressor ID: SD7H15; Manufacturer Restriction: Sanden; New Part: 1; Number of Ribs: 2 Compressor ID: SD7H15; Manufacturer Restriction: Sanden; New Part: 1; Number of Ribs: 2 Diameter 1 [mm]: 11.1; Diameter 2 [mm]: 14; Diameter 3 [mm]: 17.2; Diameter 4 [mm]: 7.65; R 134a	8FC 351 300-061 Condenser, air conditioning	404
					8FK 351 119-361 Compressor, air conditioning	401
					8FK 351 126-201 Compressor, air conditioning	401
					8UW 351 234-041 Expansion Valve, air conditioning	410
MAN - L 2000						10/93→
10.145 LC,10.145 LLC, LRC, LLRC (LE140C)	103 kW		09/00→	+ OE 81619206028; without dehumidifier + OE 51779707011 / + OE 51779707014; Compressor ID: SD7H15; Manufacturer Restriction: Sanden; New Part: 1; Number of Ribs: 2	8FC 351 306-071 Condenser, air conditioning	406
10.145 LK, LRK, L-KI, LR-KI (LE140C)	103 kW		09/00→		8FK 351 119-361 Compressor, air conditioning	401
10.145 LLS, LLRS (LE140C)	103 kW		09/00→			
9.185 LC,9.185 LLC, LRC, LLRC (LE180C)	132 kW		09/00→			
9.185 LK, LRK, L-KI, LR-KI (LE180C)	132 kW		09/00→			
9.185 LLS, LLRS (LE 180C)	132 kW		09/00→			
9.225 LC,9.225 LLC, LRC, LLRC (LE220C)	162 kW		09/00→			
9.225 LK, LRK, L-KI, LR-KI (LE220C)	162 kW		09/00→			
9.225 LLS, LLRS (LE220C)	162 kW		09/00→			
10.150 FOC 10.163 LAK, LAEK, LARK, LAERK	114 - 118 kW 114 - 118 kW		02/95→01/96 01/95→	Depth [mm]: 48; L 596 mm; without dehumidifier; Vers. produced by BEHR; W 247 mm	8FC 351 317-611 Condenser, air conditioning	406
10.153 LAEK 10.153 LC,10.153 LLC 10.153 LK 10.153 LLS 10.163 LAC, LAEC, LARC, LAERC	114 kW 114 kW 114 kW 114 kW 114 - 118 kW		10/93→06/96 10/93→06/96 10/93→06/96 10/93→06/96 05/94→	+ OE 81619206028; without dehumidifier	8FC 351 306-071 Condenser, air conditioning	406
10.163 LC,10.163 LLC 10.163 LC,10.163 LLC, LRC, LLRC (LE160C)	114 - 118 kW 114 kW		05/94→ 09/00→	Depth [mm]: 48; L 596 mm; without dehumidifier; Vers. produced by BEHR; W 247 mm	8FC 351 317-611 Condenser, air conditioning	406
10.163 LK, LRK, L-KI, LR-KI 10.163 LLS, LLRS	114 - 118 kW 114 - 118 kW		05/94→ 05/94→			
8.103 LK 8.113 LC, 8.113 LLC 8.113 LC,8.113 LLC, LRC, LLRC, (LE110C)	75 kW 81 kW 83 kW		10/93→06/96 08/95→ 09/00→			
8.113 LK, LRK, L-KI, LR-KI 8.145, LA-LF LAE-LF 8.153 LAEC 8.153 LAEK 8.153 LC,8.153 LLC 8.153 LK 8.163 LAC, LAEC, LARC, LAERC, LA-LF, LAE-LF	81 kW 103 kW 114 kW 114 kW 114 kW 114 kW 114 - 118 kW		08/95→ 07/00→ 01/95→06/96 01/95→09/96 10/93→07/97 10/93→07/97 01/95→			
8.163 LAEC 8.163 LC,8.163 LLC 8.163 LC,8.163 LLC, LRC, LLRC, L-LF 8.163 LC, 8.163 LLC (LE160C)	104 kW 114 - 118 kW 104 kW		08/95→03/97 05/94→ 08/95→			
8.163 LK, LRK, L-KI, LR-KI 8.163 LLS, LLRS 9.153 LC,9.153 LLC 9.153 LK	114 kW 114 - 118 kW 114 kW 114 kW		09/00→ 05/94→ 05/94→ 10/93→06/96 10/93→06/96			

Manufacturer - Model	Power	Displ.	Year of Constr.	Remark	Part Number	Page
MAN - L 2000						10/93→
9.163 LC	104 kW		08/95→03/97	+ OE 81619206028; without dehumidifier	8FC 351 306-071	406
9.163 LC,9.163 LLC, LRC, LLRC	114 - 118 kW		05/94→		Condenser, air conditioning	
9.163 LK	104 kW		08/95→03/97			
9.163 LK, LRK, L-KI, LR-KI	114 - 118 kW		05/94→	Depth [mm]: 48; L 596 mm; without dehumidifier; Vers. produced by BEHR; W 247 mm	8FC 351 317-611	406
9.163 LLS, LLRS	114 - 118 kW		05/94→		Condenser, air conditioning	
10.155 LK, LRK	114 kW		02/04→	+ OE 81619206028; without dehumidifier	8FC 351 306-071	406
8.103 LC, 8.103 LLC	75 kW		10/93→06/96		Condenser, air conditioning	
8.155 L, LR, LC, LLC, LRC, LLRC, L-LF	114 kW		02/04→			
8.155 LK, LRK	114 kW		02/04→	Depth [mm]: 48; L 596 mm; without dehumidifier; Vers. produced by BEHR; W 247 mm	8FC 351 317-611	406
8.155 LLS, LLRS	114 kW		02/04→		Condenser, air conditioning	
8.163 LAK, LARK, LAEK, LAERK	104 kW		04/00→	Compressor ID: SD7H15; Manufacturer Restriction: Sanden; New Part: 1; Number of Ribs: 2	8FK 351 119-361	401
9.155 L, LC, LLC, LRC, LLRC	114 kW		02/04→		Compressor, air conditioning	
9.155 LK, LRK	114 kW		02/04→			
9.155 LLS, LLRS	114 kW		02/04→			
10.185 LAC, LAEC, LARC, LAERC, LA-LA, LAE-LF (LE180C)	132 kW		09/00→	+ OE 81619206028; without dehumidifier	8FC 351 306-071	406
10.185 LAK, LAEK, LARK, LAERK (LE180C)	132 kW		09/00→	Depth [mm]: 48; L 596 mm; without dehumidifier; Vers. produced by BEHR; W 247 mm	8FC 351 317-611	406
10.185 LC,10.185 LLC, LRC, LLRC (LE180C)	132 kW		09/00→		Condenser, air conditioning	
10.185 LK, LRK, L-KI, LR-KI (LE180C)	132 kW		09/00→	+ OE 51779707011 / + OE 51779707014; Compressor ID: SD7H15; Manufacturer Restriction: Sanden; New Part: 1; Number of Ribs: 2	8FK 351 119-361	401
10.185 LLS, LLRS (LE180C)	132 kW		09/00→		Compressor, air conditioning	
10.220 FOC,10.220 FOCL	162 kW		02/95→			
10.223 LAEC	162 kW		01/95→06/96			
10.223 LC,10.223 LLC	162 - 169 kW		10/93→06/96			
10.223 LK	162 - 169 kW		10/93→06/96			
10.223 LLS	162 - 169 kW		10/93→06/96			
10.224 LAC, LAEC, LARC, LAERC	162 kW		01/95→			
10.224 LAK, LAEK, LARK, LAERK	162 kW		01/95→			
10.224 LC,10.224 LLC, LRC, LLRC	162 kW		05/94→			
10.224 LK, LRK, L-KI, LR-KI	162 kW		05/94→			
10.224 LLS, LLRS	162 kW		05/94→			
10.225 LAC, LAEC, LARC, LAERC, LA-LF, LAE-LF (LE220C)	162 kW		09/00→			
10.225 LAK, LAEK, LARK, LAERK (LE220C)	162 kW		09/00→			
10.225 LC, 10.225 LLC, LRC, LLRC (LE220C)	162 kW		09/00→			
10.225 LK, LRK, L-KI, LR-KI(LE220C)	162 kW		09/00→			
10.225 LLS, LLRS (LE220C)	162 kW		09/00→			
12.185 LC, LLC (LE180C)	132 kW		09/99→			
12.225 LC, LLC (LE220C)	162 kW		09/99→			
8.145 LC,8.145 LLC, L-LF (LE140C)	103 kW		09/00→			
8.145 LLS, LLRS (LE140C)	103 kW		09/00→			
8.145 LRK, L-KI, LR-KILK (LE140C)	103 kW		09/00→			
8.185 LAC, LAEC, LARC, LAERC, LA-LF, LAE-LF (LE180C)	132 kW		09/00→			
8.185 LAK, LAEK, LARK, LAERK (LE180C)	132 kW		09/00→			
8.185 LC,8.185 LLC, LRC, LLRC, L-LF (LE180C)	132 kW		09/00→			
8.185 LK, LRK, L-KI, LR-KI (LE180C)	132 kW		09/00→			
8.185 LLS, LLRS (LE180C)	132 kW		09/00→			
8.220 FOC,8.220 FOCL	162 kW		04/95→			
8.223 LAEC	162 kW		01/95→06/96			
8.223 LC,8.223 LLC	162 - 169 kW		10/93→06/96			
8.223 LK	162 - 169 kW		10/93→06/96			
8.223 LLS	162 - 169 kW		10/93→06/96			
8.224 LAC, LAEC, LARC, LAERC	162 kW		01/95→			
8.224 LAK, LAEK, LARK, LAERK	162 kW		01/95→			
8.224 LC,8.224 LLC, LRC, LLRC	162 kW		05/94→			
8.224 LK, LRK, L-KI, LR-KI	162 kW		05/94→			
8.224 LLS, LLRS	162 kW		05/94→			
8.225 LAC, LAEC, LARC, LAERC (LE220C)	162 kW		09/00→			
8.225 LAK, LAEK, LARK, LAERK (LE220C)	162 kW		09/00→			

Manufacturer - Model	Power	Displ.	Year of Constr.	Remark	Part Number	Page
MAN - L 2000						10/93→
8.225 LC,8.225 LLC, LRC, LLRC (LE220C)	162 kW		09/00→	+ OE 81619206028; without dehumidifier	8FC 351 306-071	406
8.225 LK, LRK, L-KI, LR-KI (LE220C)	162 kW		09/00→		Condenser, air conditioning	
8.225 LLS, LLRS (LE220C)	162 kW		09/00→	Depth [mm]: 48; L 596 mm; without dehumidifier; Vers. produced by BEHR; W 247 mm	8FC 351 317-611	406
9.145 LC,9.145 LLC, LRC, LLRC (LE140C)	103 kW		09/00→		Condenser, air conditioning	
9.145 LK, LRK, L-KI, LR-KI (LE140C)	103 kW		09/00→	+ OE 51779707011 / + OE 51779707014; Compressor ID: SD7H15; Manufacturer Restriction: Sanden; New Part: 1; Number of Ribs: 2	8FK 351 119-361	401
9.145 LLS, LLRS (LE140C)	103 kW		09/00→		Compressor, air conditioning	
9.223 LC,9.223 LLC	162 - 169 kW		10/93→06/96			
9.223 LK	162 - 169 kW		10/93→06/96			
9.223 LLS	162 - 169 kW		10/93→06/96			
9.224 LC,9.224 LLC, LRC, LLRC	162 kW		05/94→			
9.224 LK, LRK, L-KI, LR-KI	162 kW		05/94→			
9.224 LLS, LLRS	162 kW		05/94→			
10.225 LC, 10.225 LLC, LRC, LLRC	162 kW		09/00→	+ OE 81619206028; without dehumidifier	8FC 351 306-071	406
8.153 LLS	114 kW		10/93→06/96		Condenser, air conditioning	
9.153 LLS	114 kW		10/93→12/95			
MAN - M 90						08/88→06/96
12.152 F,12.152 FL	110 - 114 kW		12/88→05/94	Depth [mm]: 48; L 652 mm; without dehumidifier; Vers. produced by BEHR; W 286 mm	8FC 351 300-071	405
12.152 FK	110 - 114 kW		12/88→05/94		Condenser, air conditioning	
12.152 FS,12.152 FLS	110 - 114 kW		12/88→05/94			
12.192 F,12.192 FL	140 kW		07/90→06/96			
12.192 FA	140 kW		10/92→06/96		8UW 351 234-041	410
12.192 FAK	140 kW		10/92→06/96		Expansion Valve, air conditioning	
12.192 FK	140 kW		07/90→06/96			
12.192 FS,12.192 FLS	140 kW		07/90→06/96			
12.232 F,12.232 FL	169 kW		08/88→06/96			
12.232 FA	169 kW		05/90→06/96			
12.232 FAK	169 kW		05/90→06/96			
12.232 FK	169 kW		08/88→06/96			
12.232 FS,12.232 FLS	169 kW		08/88→06/96			
12.272 F,12.272 FL	198 kW		09/91→10/92			
12.272 F,12.272 FL	198 kW		10/92→06/96			
12.272 FK	198 kW		09/91→10/92			
12.272 FK	198 kW		10/92→06/96			
12.272 FS,12.272 FLS	198 kW		09/91→10/92			
12.272 FS,12.272 FLS	198 kW		10/92→06/96			
14.152 F,14.152 FL	110 - 114 kW		12/88→04/94			
14.152 FK	110 - 114 kW		12/88→05/94			
14.152 FS,14.152 FLS	110 - 114 kW		12/88→05/94			
14.232 F,14.232 FL	169 kW		08/88→06/96			
14.232 FK	169 kW		08/88→06/96			
14.232 FS,14.232 FLS	169 kW		08/88→06/96			
14.272 F,14.272 FL	198 kW		10/92→06/96			
14.272 FK	198 kW		10/92→06/96			
14.272 FS,14.272 FLS	198 kW		12/92→06/96			
17.192 F,17.192 FL	140 kW		07/90→04/95			
17.192 FA	140 kW		07/90→06/96			
17.192 FAK	140 kW		07/90→06/96			
17.192 FS,17.192 FLS	140 kW		07/90→04/95			
17.232 F,17.232 FL	169 kW		08/88→04/95			
17.232 FA	169 kW		02/89→06/96			
17.232 FAK	169 kW		02/89→06/96			
17.232 FS,17.232 FLS	169 kW		08/88→04/95			
18.192 F,18.192 FL,18.192 FLL	140 kW		09/90→06/96			
18.232 F,18.232 FL,18.232 FLL	169 kW		09/90→06/96			
18.232 FK	169 kW		09/90→06/96			
18.272 F,18.272 FL,18.272 FLL	198 kW		10/92→06/96			
24.192 FNL,24.192 FNLL,24.192 FVL	140 kW		07/89→06/96			
24.232 FNL,24.232 FNLL,24.232 FVL	169 kW		07/89→06/96			
24.272 FNL,24.272 FNLL,24.272 FVL	198 kW		10/92→06/96			
12.272 FA	198 kW		10/93→04/95	Depth [mm]: 48; L 652 mm; without dehumidifier; Vers. produced by BEHR; W 286 mm	8FC 351 300-071	405
12.272 FAK	198 kW		10/93→04/95		Condenser, air conditioning	
14.192 F,14.192 FL	140 kW		07/90→06/96			
14.192 FK	140 kW		07/90→06/96			
14.192 FS,14.192 FLS	140 kW		07/90→06/96			
18.272 FK	198 kW		10/92→06/96			
MAN - M 2000 L						08/95→
12.145 LC, LLC, LRC, LLRC	107 kW		05/01→	+ OE 81619206028; without dehumidifier	8FC 351 306-071	406
12.145 LK, LRK	107 kW		05/01→		Condenser, air conditioning	
12.185 LC, LLC, LRC, LLRC	132 - 136 kW		05/01→			
12.185 LK, LRK	132 - 136 kW		05/01→			

Manufacturer - Model	Power	Displ.	Year of Constr.	Remark	Part Number	Page
MAN - M 2000 L						08/95→
12.225 LC, LLC, LLLC, LRC, LLRC	162 kW		05/01→	+ OE 81619206028; without dehumidifier	8FC 351 306-071 Condenser, air conditioning	406
12.255 LC, LLC, LLLC	180 kW		08/02→			
12.255 LK	180 kW		10/03→			
12.285 LC, LLC, LLLC	206 kW		08/02→			
12.285 LK	206 kW		10/03→			
14.185 LC, LLC, LRC, LLRC	132 - 136 kW		05/01→			
14.185 LK, LRK	132 - 136 kW		05/01→			
14.224, 14.225, LA-LF	162 kW		07/03→			
14.255 LAC, LARC	180 kW		11/02→			
14.255 LAK, LARK	180 kW		11/02→			
14.255 LA-LF	180 kW		07/03→			
14.255 LK, LRK	180 kW		11/02→			
14.264 LA-LF	191 kW		07/03→			
15.185 LC, LRC	132 - 136 kW		05/01→			
15.185 LK, LRK	132 - 136 kW		11/02→			
18.224, 18.225, L-KO, LR-KO	162 kW		05/01→			
18.255 LAC, LARC	180 kW		05/01→			
18.255 LAK, LARK	180 kW		05/01→			
18.255 LK, LK, LRK, LLRK	180 kW		11/02→			
18.255 L-KO, LR-KO	180 kW		05/01→			
18.263, 18.264, L-KO, LR-KO	191 kW		05/01→			
19.224, 19.225, LLC	162 kW		05/01→			
19.255 LLC	180 kW		05/01→			
19.264 LLC	191 kW		05/01→			
19.284, 19.285, LLC	206 kW		05/01→			
20.224 LNLC, LNLLC	162 kW		05/01→			
20.255 LNLC, LNLLC	180 kW		05/01→			
20.264 LNLC, LNLLC	191 kW		05/01→			
20.284, 20.285, LNLC, LNLLC	206 kW		05/01→			
26.224, 26.225, DL-HK, DLR-HK	180 kW		11/02→			
26.255 DL-HK, DLR-HK	180 kW		11/02→			
26.284, 26.285, DL-HK, DLR-HK	206 kW		11/02→			
26.284 DL-TM, DLR-TM	206 kW		05/01→			
12.163 LC, LLC, LRC, LLRC	114 kW		08/95→	+ OE 81619206028; without dehumidifier	8FC 351 306-071 Condenser, air conditioning	406
12.163 LK, LRK	114 kW		08/95→			
14.163 LC, LLC, LRC, LLRC	114 kW		08/95→			
14.163 LK, LRK	114 kW		08/95→	Depth [mm]: 48; L 596 mm; without dehumidifier; Vers. produced by BEHR; W 247 mm	8FC 351 317-611 Condenser, air conditioning	406
15.163 LC, LLC, LRC	114 kW		08/95→			
15.163 LK, LRK	114 kW		08/95→			
12.224, 12.225, LK, LRK	162 kW		08/95→	+ OE 81619206028; without dehumidifier	8FC 351 306-071 Condenser, air conditioning	406
12.224 LC, LLC, LRC, LLRC	162 kW		08/95→			
				Depth [mm]: 48; L 596 mm; without dehumidifier; Vers. produced by BEHR; W 247 mm	8FC 351 317-611 Condenser, air conditioning	406
				+ OE 51779707011 / + OE 51779707014; Compressor ID: SD7H15; Manufacturer Restriction: Sanden; New Part: 1; Number of Ribs: 2	8FK 351 119-361 Compressor, air conditioning	401
14.224 LAC, LARC	162 kW		08/95→	Depth [mm]: 16; L 545 mm; without dehumidifier; W 520 mm	8FC 351 301-021 Condenser, air conditioning	405
14.224 LAK, LARK	162 kW		08/95→			
14.224 LC, LLC, LLLC, LRC, LLRC, LLLRC	162 kW		08/95→			
14.224 LK, LRK	162 kW		08/95→	+ OE 81619206028; without dehumidifier	8FC 351 306-071 Condenser, air conditioning	406
14.225 LAC, LARC, (LE220B)	162 kW		09/00→			
14.225 LAK, LARK, (LE220B)	162 kW		09/00→			
14.225 LC, LLC, LLLC, LRC, LLRC, LLLRC, (LE220B)	162 kW		09/00→	Depth [mm]: 48; L 596 mm; without dehumidifier; Vers. produced by BEHR; W 247 mm	8FC 351 317-611 Condenser, air conditioning	406
14.225 LK, LRK (LE220B)	162 kW		09/00→			
14.255 LC, LLC, LLLC, LRC, LLRC, LLLRC, (LE250B)	180 kW		09/00→			
14.263, 14.264 LAC, LARC	191 kW		08/95→			
14.263, 14.264 LAK, LARK	191 kW		08/95→			
14.263, 14.264 LC, LLC, LLLC, LRC, LLRC, LLLRC	191 kW		08/95→			
14.263, 14.264 LK, LRK	191 kW		08/95→			
14.285 LC, LLC, LLLC, LRC, LLRC, LLLRC, (LE280B)	206 kW		09/00→			
15.224 LC, LLC, LLLC, LRC, LLRC, LLLRC	162 kW		08/95→			
15.224 LK, LRK	162 kW		08/95→			
15.225 LC, LLC, LLLC, LRC, LLRC, LLLRC, (LE220B)	162 kW		09/99→			
15.225 LK, LRK, (LE220B)	162 kW		09/99→			
15.255 LC, LLC, LLLC, LRC, LLRC, LLLRC, (LE250B)	180 kW		09/99→			
15.255 LK, LRK, (LE250B)	180 kW		09/99→			
15.263, 15.264 LC, LLC, LLLC, LRC, LLRC, LLLRC	191 kW		08/95→			
15.263, 15.264 LK, LRK	191 kW		08/95→			

Manufacturer - Model	Power	Displ.	Year of Constr.	Remark	Part Number	Page			
MAN - M 2000 L						08/95→			
15.285 LC, LLC, LLLC, LRC, LLRC, LLLRC, (LE280B)	206 kW		09/99→	Depth [mm]: 16; L 545 mm; without dehumidifier; W 520 mm	8FC 351 301-021 Condenser, air conditioning	405			
15.285 LK, LRK, (LE280B)	206 kW		09/99→	+ OE 81619206028; without dehumidifier	8FC 351 306-071 Condenser, air conditioning	406			
18.224, 18.225, LAC, LARC	162 kW		08/95→						
18.224, 18.225, LAK, LARK	162 kW		08/95→						
18.224, 18.225, LC, LLC, LLLC, LRC, LLRC, LLLRC	162 kW		08/95→						
18.224, 18.225, LK, LLK, LRK, LLRK	162 kW		08/95→	Depth [mm]: 48; L 596 mm; without dehumidifier; Vers. produced by BEHR; W 247 mm	8FC 351 317-611 Condenser, air conditioning	406			
18.255 LC, LLC, LLLC, LRC, LLRC, LLLRC, (LE250B)	180 kW		09/99→	+ OE 51779707011 / + OE 51779707014; Compressor ID: SD7H15; Manufacturer Restriction: Sanden; New Part: 1; Number of Ribs: 2	8FK 351 119-361 Compressor, air conditioning	401			
18.263, 18.264, LAC, LARC	191 kW		08/95→						
18.263, 18.264, LAK, LARK	191 kW		08/95→						
18.263, 18.264, LC, LLC, LLLC, LRC, LLRC, LLLRC	191 kW		08/95→						
18.263, 18.264, LK, LLK, LRK, LLRK	191 kW		08/95→						
18.285 LAC, LARC (LE280B)	206 kW		09/99→						
18.285 LC, LLC, LLLC, LRC, LLRC, LLLRC, (LE280B)	206 kW		09/99→						
18.285 LAK, LARK, (LE280B)	206 kW		09/99→	Depth [mm]: 16; L 545 mm; without dehumidifier; W 520 mm	8FC 351 301-021 Condenser, air conditioning	405			
				Depth [mm]: 48; L 596 mm; without dehumidifier; Vers. produced by BEHR; W 247 mm	8FC 351 317-611 Condenser, air conditioning	406			
				+ OE 51779707011 / + OE 51779707014; Compressor ID: SD7H15; Manufacturer Restriction: Sanden; New Part: 1; Number of Ribs: 2	8FK 351 119-361 Compressor, air conditioning	401			
MAN - M 2000 M						08/95→			
12.224 MC, MLC	162 kW		02/03→	+ OE 81619206028; without dehumidifier	8FC 351 306-071 Condenser, air conditioning	406			
12.224 MLS	162 kW		02/03→						
12.255 MC, MLC	180 kW		02/03→						
12.255 MLS	180 kW		02/03→						
12.264 MC, MLC	191 kW		02/03→						
12.264 MLS	191 kW		02/03→						
12.284 MC, MLC	206 kW		02/00→						
12.284 MLS	206 kW		02/00→						
14.224 MA-KO, MA-LF	162 kW		11/02→						
14.255 MAK	180 kW		11/02→						
14.255 MA-KO, MA-LF	180 kW		11/02→						
14.264 MAK	191 kW		11/02→						
14.264 MA-KO, MA-LF	191 kW		11/02→						
18.224 M-KO, MR-KO	162 kW		02/00→						
18.255 MAK, MARK	180 kW		10/00→						
18.255 MK, MLK, MRK, MLRK	180 kW		11/02→						
18.255 M-KO, MR-KO	180 kW		10/00→						
18.264 M-KO, MR-KO	191 kW		02/00→						
18.284 M-KO, MR-KO	206 kW		02/00→						
14.224 MAK	162 kW		08/95→12/05				Depth [mm]: 48; L 652 mm; without dehumidifier; Vers. produced by BEHR; W 286 mm	8FC 351 300-071 Condenser, air conditioning	405
14.224 MC, MLC, MLLC	162 kW		08/95→12/05						
14.264 MC, MLC, MLLC	191 kW		08/95→12/05	Compressor ID: SD7H15; Manufacturer Restriction: Sanden; New Part: 1; Number of Ribs: 2	8FK 351 119-361 Compressor, air conditioning	401			
14.264 MLS, MLRS	191 kW		08/95→12/05						
18.224 MAC, MARC	162 kW		08/95→12/05	Diameter 1 [mm]: 11.1; Diameter 2 [mm]: 14; Diameter 3 [mm]: 17.2; Diameter 4 [mm]: 7.65; R 134a	8UW 351 234-041 Expansion Valve, air conditioning	410			
18.224 MAK, MARK	162 kW		08/95→12/05						
18.224 MC, MLC, MLLC, MRC, MLRC, MLLRC	162 kW		08/95→12/05						
18.224 MK, 18.224 MLK, MRK, MLRK	162 kW		08/95→12/05						
18.264 MAC, MARC	191 kW		08/95→12/05						
18.264 MAK, MARK	191 kW		08/95→12/05						
18.264 MC, MLC, MLLC, MRC, MLRC, MLLRC	191 kW		08/95→12/05						
18.264 MK, 18.264 MLK, MRK, MLRK	191 kW		08/95→12/05						
25.224 MNL, MNLLC, MNLRC, MNLLRC, MVLC	162 kW		08/95→12/05						
25.264 MNL, MNLLC, MNLRC, MNLLRC, MVLC	191 kW		08/95→12/05						
14.224 MK	162 kW		08/95→12/05				Depth [mm]: 48; L 652 mm; without dehumidifier; Vers. produced by BEHR; W 286 mm	8FC 351 300-071 Condenser, air conditioning	405
14.224 MLS, MLRS	162 kW		08/95→12/05						
18.264 MLS, MLRS	191 kW		08/95→12/05						
				Compressor ID: SD7H15; Manufacturer Restriction: Sanden; New Part: 1; Number of Ribs: 2	8FK 351 119-361 Compressor, air conditioning	401			
14.225 MC, MLC, MLLC	162 kW		10/00→	+ OE 81619206028; without dehumidifier	8FC 351 306-071 Condenser, air conditioning	406			
14.225 MLS, MLRS	162 kW		02/03→						
14.255 MC, MLC, MLLC	180 kW		10/00→						

Manufacturer - Model	Power	Displ.	Year of Constr.	Remark	Part Number	Page			
MAN - M 2000 M						08/95→			
14.255 MLS, MLRS	180 kW		10/00→	Compressor ID: SD7H15; Manufacturer Restriction: Sanden; New Part: 1; Number of Ribs: 2	8FK 351 119-361 Compressor, air conditioning	401			
14.285 MLS, MLRS	206 kW		02/03→						
18.225 MAC, MARC	162 kW		02/03→						
18.225 MC, MLC, MLLC, MRC, MLRC, MLLRC	162 kW		10/00→						
18.255 MAC, MARC	180 kW		10/00→						
18.255 MC, MLC, MLLC, MLRC, MLLRC	180 kW		10/00→						
18.255 MLS, MLRS	180 kW		10/00→						
18.285 MAC, MARC	206 kW		02/03→						
18.285 MC, MLC, MLLC	206 kW		06/98→12/05						
18.285 MLS, MLRS	206 kW		02/03→						
25.225 MNLC, MNLLC, MNLRC, MNLLRC, MVLC	162 kW		02/03→						
25.255 MNLC, MNLLC, MNLRC, MNLLRC, MVLC	180 kW		10/00→						
25.284 MNLC, MNLLC, MNLRC, MNLLRC, MVLC	206 kW		02/00→						
25.285 MNLC, MNLLC, MNLRC, MNLLRC, MVLC	206 kW		02/03→						
14.284 MAK	206 kW		06/98→12/05				Compressor ID: SD7H15; Manufacturer Restriction: Sanden; New Part: 1; Number of Ribs: 2	8FK 351 119-361 Compressor, air conditioning	401
14.284 MA-KO, MA-LF	206 kW		06/98→12/05						
14.284 MC, MLC, MLLC	206 kW		06/98→12/05						
14.284 MLS, MLRS	206 kW		06/98→12/05						
18.224 MLS, MLRS	162 kW		08/95→12/05						
18.284 MAC, MARC	206 kW		06/98→12/05						
18.284 MAK, MARK	206 kW		06/98→12/05						
18.284 MC, MLC, MLLC, MRC, MLRC, LLRC	206 kW		06/98→12/05						
18.284 MK, 18.284 MLK, MRK, MLRK	206 kW		06/98→12/05						
18.284 MLS, MLRS	206 kW		06/98→12/05						
14.285 MLC, MLLC (ME280C)	206 kW		09/99→12/05	+ OE 81619206028; without dehumidifier	8FC 351 306-071 Condenser, air conditioning	406			
				Compressor ID: SD7H15; Manufacturer Restriction: Sanden; New Part: 1; Number of Ribs: 2	8FK 351 119-361 Compressor, air conditioning	401			
				+ OE 51779707011 / + OE 51779707014; Compressor ID: SD7H15; Manufacturer Restriction: Sanden; New Part: 1; Number of Ribs: 2	8FK 351 119-361 Compressor, air conditioning	401			
MAN - TGA						04/00→			
18.310, 18.320 FAC, FHLC	228 - 235 kW		05/04→	Depth [mm]: 16; L 750 mm; without dehumidifier; Vers. produced by BEHR; W 351 mm	8FC 351 300-121 Condenser, air conditioning	405			
18.310, 18.320 FAK, FAK-L, FALK, FALK-L, FHLK, FHLK/M	228 - 235 kW		05/04→						
18.310, 18.320 FAS, FALS, FHLS, FHLS/M	228 - 235 kW		05/04→	Compressor ID: SD7H15; Manufacturer Restriction: Sanden; New Part: 1; Number of Ribs: 8	8FK 351 135-141 Compressor, air conditioning	402			
18.310, 18.320 FC, FLC, FLLC, FLLC/N, FLLW, FLLW/N	228 - 235 kW		05/04→	Compressor ID: SD7H15; Manufacturer Restriction: Sanden; Number of Ribs: 8	8FK 351 135-641 Compressor, air conditioning BEHR HELLA SERVICE Version ALTERNATIVE	403			
18.310, 18.320 FK, FK-L, FLK, FLK/M	228 - 235 kW		05/04→		8FT 351 197-481 Dryer, air conditioning	408			
18.310, 18.320 FLS, FLRS, FLLS, FLLRS	228 - 235 kW		05/04→		8FV 351 336-111 Evaporator, air conditioning	409			
18.350, 18.360 FAC, FHLC	257 - 265 kW		05/04→	Depth [mm]: 65; L 307 mm; with expansion valve; Vers. produced by BEHR; W 200 mm	8UW 351 336-161 Expansion Valve, air conditioning	410			
18.350, 18.360 FAK, FAK-L, FALK, FALK-L, FHLK, FHLK/M	257 - 265 kW		05/04→						
18.350, 18.360 FAS, FALS, FHLS, FHLS/M	257 - 265 kW		05/04→						
18.350, 18.360 FC, FLC, FLLC, FLLRC, FLLC/N, FLLW, FLLW/N	257 - 265 kW		05/04→						
18.350, 18.360 FK, FK-L, FLK, FLK/M	257 - 265 kW		05/04→	Diameter 1 [mm]: 18; Diameter 2 [mm]: 18; Diameter 3 [mm]: 10; Diameter 4 [mm]: 12; + OE 81.61967.0020; R 134a					
18.350 FLS, FLS/N, FLS/M, FLS-TS, FLLS, FLLS/N, FLLRS	257 kW		05/04→						
18.390, 18.400 FAC, FHLC	287 - 294 kW		05/04→						
18.390, 18.400 FAK, FAK-L, FALK, FALK-L, FHLK, FHLK/M	287 - 294 kW		05/04→						
18.390, 18.400 FAS, FALS, FHLS, FHLS/M	287 - 294 kW		05/04→						
18.390, 18.400 FC, FLC, FLLC, FLLC/N, FLLW, FLLW/N	287 - 294 kW		05/04→						
18.390, 18.400 FK, FK-L, FLK, FLK/M	287 - 294 kW		05/04→						
18.390 FLS, FLS-TS, FLS/M, FLLS, FLLS/N, FLLS/M, FLLRS	287 kW		05/04→						
18.430, 18.440 FAC, FHLC	316 - 324 kW		05/04→						
18.430, 18.440 FAK, FALK, FALK-L, FHLK, FHLK/M	316 - 324 kW		05/04→						

Manufacturer - Model	Power	Displ.	Year of Constr.	Remark	Part Number	Page
MAN - TGA						04/00→
18.430, 18.440 FAS, FALS, FHLS, FHLS/M	316 - 324 kW		05/04→	Depth [mm]: 16; L 750 mm; without dehumidifier; Vers. produced by BEHR; W 351 mm	8FC 351 300-121	405
18.430, 18.440 FC, FLC, FLLC, FLLW, FLLW/N, FLLRC, FLLRW	316 - 324 kW		05/04→		Compressor ID: SD7H15; Manufacturer Restriction: Sanden; New Part: 1; Number of Ribs: 8	8FK 351 135-141
18.430, 18.440 FK, FK-L, FLK, FLK/M	316 - 324 kW		05/04→	Compressor ID: SD7H15; Manufacturer Restriction: Sanden; Number of Ribs: 8	8FK 351 135-641	403
18.430 FLS, FLS/M, FLS-TS, FLLS, FLLS/N, FLLRS, FLRS	316 kW		05/04→		Compressor, air conditioning BEHR	
18.480 FC, FLC, FLLC, FLLRC, FLLW, FLRC	353 kW		01/06→		HELLA SERVICE	
18.480 FHLC	353 kW		04/06→		Version ALTERNATIVE	
18.480 FHLK, FHLK/M	353 kW		04/06→			
19.360 FS/M-WW, FRS/M-WW	265 kW		05/04→		8FT 351 197-481	408
19.410 FS/M-WW, FRS/M-WW	301 kW		05/04→		air conditioning	
19.460 FS/M-WW, FRS/M-WW	338 kW		05/04→	Depth [mm]: 65; L 307 mm; with expansion valve; Vers. produced by BEHR; W 200 mm	8FV 351 336-111	409
19.480 FS/M-WW, FRS/M-WW	353 kW		05/04→		Evaporator, air conditioning	
24.350, 24.360 FNLLC, FNLLW/N, FNLLRW	257 - 265 kW		05/04→	Diameter 1 [mm]: 18; Diameter 2 [mm]: 18; Diameter 3 [mm]: 10; Diameter 4 [mm]: 12; + OE 81.61967.0020; R 134a	8UW 351 336-161	410
24.350, 24.360 FPLS, FPLRS	257 - 265 kW		02/04→		Expansion Valve, air conditioning	
24.390, 24.400 FNLLC/N, FNLLW/N, FNLLRC, FNLLRW	287 - 294 kW		05/04→			
24.390, 24.400 FPLS, FPLRS	287 - 294 kW		05/04→			
24.430, 24.440 FNLLC/N, FNLRC, FNLLW	316 - 324 kW		05/04→			
24.430, 24.440 FPLS, FPLRS	316 - 324 kW		05/04→			
26.310, 26.320 FDC, FDRC, FDC/M, FDRC/M, FDLC, FNHLC, FVHLC	228 - 235 kW		05/04→			
26.310, 26.320 FDH, FDHC, FDHC/M	228 - 235 kW		06/05→			
26.310, 26.320 FDHK	228 - 235 kW		06/05→			
26.310, 26.320 FDHS, FDHS/M	228 - 235 kW		06/05→			
26.310, 26.320 FDH-TM	228 - 235 kW		06/05→			
26.310, 26.320 FDK, FDLK	228 - 235 kW		05/04→			
26.310, 26.320 FDS, FDS/M, FDLs, FDRS, FDRS/M, FNHLS, FDLRS	228 - 235 kW		05/04→			
26.310, 26.320 FD-TM	228 - 235 kW		06/05→			
26.310, 26.320 FNLC, FNLLC, FNLRC, FNLLRC, FNLLW	228 - 235 kW		05/04→			
26.310, 26.320 FNLS, FNLLS, FNLRS, FNLLRS	228 - 235 kW		05/04→			
26.310, 26.320 FVHL-KO	228 - 235 kW		06/05→			
26.310, 26.320 FVLC	228 - 235 kW		02/04→			
26.310, 26.320 FVL-KO	228 - 235 kW		02/04→			
26.350, 26.360 FDC, FDRC, FDC/M, FDRC/M, FDLC, FDLRC, FNHLC	257 - 265 kW		05/04→			
26.350, 26.360 FDHK, FDHLK	257 - 265 kW		05/04→			
26.350, 26.360 FDHS, FDHS/M, FDHLS	257 - 265 kW		05/04→			
26.350, 26.360 FDH-TM	257 - 265 kW		05/04→			
26.350, 26.360 FDK, FDLK, FDRK	257 - 265 kW		05/04→			
26.350, 26.360 FDS, FDS/M, FDLs, FDRS, FNHLS, FPHLS	257 - 265 kW		05/04→			
26.350, 26.360 FD-TM	257 - 265 kW		02/04→			
26.350, 26.360 FNLC, FNLLC, FNLLW, FNLRC, FNLLRC	257 - 265 kW		05/04→			
26.350, 26.360 FNLS, FNLLS, FNLRS, FNLLRS, FPLS, FPLRS	257 - 265 kW		05/04→			
26.350, 26.360 FVHL-KO	257 - 265 kW		06/05→			
26.350, 26.360 FVL-KO	257 - 265 kW		01/04→			
26.350 FDHC, FDHC/M	257 kW		04/05→			
26.360 FDLs, FDLs/M, FDLRS, FDLRS/M, FDLRS-WW, FDRS	265 kW		09/03→			
26.390, 26.400 FDC, FDRC, FDLRC, FDRC/M, FDLC, FNHLC, FVHLC	287 - 294 kW		05/04→			
26.390, 26.400 FDHC, FDHC/M, FDHLC	287 - 294 kW		06/05→			
26.390, 26.400 FDHK, FDHLK	287 - 294 kW		06/05→			
26.390, 26.400 FDHS, FDHS/M, FDHLS	287 - 294 kW		06/05→			
26.390, 26.400 FDK, FDLK	287 - 294 kW		05/04→			
26.390, 26.400 FDS, FDS/M, FDLs, FDLRS, FNHLS, FPHLS, FVHLS	287 - 294 kW		05/04→			
26.390, 26.400 FD-TM	287 - 294 kW		05/04→			
26.390, 26.400 FNLC, FNLLC, FNLLW, FNLRC, FNLLRC	287 - 294 kW		05/04→			

Manufacturer - Model	Power	Displ.	Year of Constr.	Remark	Part Number	Page
MAN - TGA						04/00→
26.390, 26.400 FNLS, FNLLS, FNLRs, FNLLRS, FPLS, FPLRS	287 - 294 kW		05/04→	Depth [mm]: 16; L 750 mm; without dehumidifier; Vers. produced by BEHR; W 351 mm	8FC 351 300-121 Condenser, air conditioning	405
26.390, 26.400 FVHL-KO	287 - 294 kW		06/05→			
26.390, 26.400 FVL-KO	287 - 294 kW		02/04→			
26.430, 26.440, FNLC, FNLLC, FNLLW, FNLRc, FNLLRc, FVLC	316 - 324 kW		05/04→	Compressor ID: SD7H15; Manufacturer Restriction: Sanden; New Part: 1; Number of Ribs: 8	8FK 351 135-141 Compressor, air conditioning	402
26.430, 26.440, FNLS, FNLLS, FNLRs, FNLLRS, FPLS, FPLRS	316 - 324 kW		05/04→	Compressor ID: SD7H15; Manufacturer Restriction: Sanden; Number of Ribs: 8	8FK 351 135-641 Compressor, air conditioning BEHR HELLA SERVICE Version ALTERNATIVE	403
26.430, 26.440 FDC, FDRC, FDLC, FDLRC, FDLc/M, FNHLc, FVHLc	316 - 324 kW		05/04→			
26.430, 26.440 FDHC, FDHC/M, FDHLc	316 - 324 kW		06/05→		8FT 351 197-481 Dryer, 408 air conditioning	408
26.430, 26.440 FDHK, FDHLK	316 - 324 kW		06/05→			
26.430, 26.440 FDHS, FDHS/M, FDHLS	316 - 324 kW		06/05→	Depth [mm]: 65; L 307 mm; with expansion valve; Vers. produced by BEHR; W 200 mm	8FV 351 336-111 Evaporator, air conditioning	409
26.430, 26.440 FDH-TM	316 - 324 kW		06/05→			
26.430, 26.440 FDK, FDLK	316 - 324 kW		05/04→			
26.430, 26.440 FDS, FDLS, FDRS, FDLRS, FNHLS, FPHLS, FVHLS	316 - 324 kW		02/04→	Diameter 1 [mm]: 18; Diameter 2 [mm]: 18; Diameter 3 [mm]: 10; Diameter 4 [mm]: 12; + OE 81.61967.0020; R 134a	8UW 351 336-161 Expansion Valve, air conditioning	410
26.430, 26.440 FD-TM	316 - 324 kW		05/04→			
26.430, 26.440 FVLH-KO	316 - 324 kW		06/05→			
26.480 FDC, FDC/M, FDLC, FDLRC, FDRC, FNHLc, FVHLc, FDLRC-WW	353 kW		02/06→			
26.480 FDHK, FDHLK	353 kW		02/06→			
26.480 FDS, FDLS, FDLRS, FNHLS, FPHLS, FVHLS	353 kW		02/06→			
26.530 FDAC, FDALC	390 kW		07/06→			
26.530 FDAK, FDALK	390 kW		09/02→			
26.530 FDAS, FDALS	390 kW		07/06→			
28.310, 28.320 FNLC, FNLLC, FNLL-LE, FNLLR-LE	228 - 235 kW		07/06→			
28.310, 28.320 FNLC, FNLLC, FNLLRC, FNLLR-LE	228 - 235 kW		07/06→			
28.350, 28.360 FNLC, FNLLC, FNLL-LE	257 - 265 kW		07/06→			
28.350, 28.360 FNLC, FNLLC, FNLRc, FNLL-LE	257 - 265 kW		06/04→			
28.360 FANLC	265 kW		07/06→			
28.390, 28.400 FNLC, FNLLC, FNLRc-WW	287 - 294 kW		06/04→			
28.390 FNLLC	353 kW		07/06→			
28.410 FANLC	301 kW		07/06→			
28.410 FANLK	301 kW		07/06→			
28.430, 28.440 FNLC, FNLLC, FNLRc-WW	316 - 324 kW		06/04→			
28.480 FANLK	353 kW		07/06→			
28.530 FANLC	390 kW		07/06→			
28.530 FANLK	390 kW		07/06→			
32.350, 32.360 FFDRC	257 - 265 kW		05/04→			
32.350, 32.360 FFD-TM, FFDRC-TM	257 - 265 kW		02/04→			
32.390, 32.400 FFDRC	287 - 294 kW		05/04→			
32.390, 32.400 FFD-TM, FFDRC-TM	287 - 294 kW		05/04→			
32.430, 32.440 FFDRC	316 - 324 kW		05/04→			
32.430, 32.440 FFD-TM, FFDRC-TM	316 - 324 kW		05/04→			
33.350, 33.360 FDAC, FDHC, FDHC/M	257 - 265 kW		06/05→			
33.350, 33.360 FDAK, FDHK	257 - 265 kW		06/05→			
33.350, 33.360 FDAS, FDHS, FDHS/M	257 - 265 kW		06/05→			
33.350, 33.360 FDC, FDC/M, FDLC, FDRC	257 - 265 kW		05/04→			
33.350, 33.360 FDK, FDLK, FDRK	257 - 265 kW		05/04→			
33.350, 33.360 FDS, FDLS, FDS/M, FDRS	257 - 265 kW		05/04→			
33.390, 33.400 FDAC, FDHC, FDHC/M	287 - 295 kW		06/05→			
33.390, 33.400 FDAK, FDHK	287 - 295 kW		06/05→			
33.390, 33.400 FDAS, FDHS, FDHS/M	287 - 295 kW		06/05→			
33.390, 33.400 FDC, FDLC, FDRC, FDC/M	287 - 294 kW		05/04→			
33.390, 33.400 FDK, FDLK, FDRK	287 - 294 kW		05/04→			

Manufacturer - Model	Power	Displ.	Year of Constr.	Remark	Part Number	Page
MAN - TGA						04/00→
33.390, 33.400 FDS, FDLs, FDLRS, FDRS, FDS/M	287 - 294 kW		05/04→	Depth [mm]: 16; L 750 mm; without dehumidifier; Vers. produced by BEHR; W 351 mm	8FC 351 300-121	405
33.430, 33.440 FDAC, FDALC, FDHC, FDHC/M	316 - 324 kW		06/05→		Compressor ID: SD7H15; Manufacturer Restriction: Sanden; New Part: 1; Number of Ribs: 8	8FK 351 135-141
33.430, 33.440 FDAK, FDALK, FDHK	316 - 324 kW		06/05→	Compressor ID: SD7H15; Manufacturer Restriction: Sanden; Number of Ribs: 8	8FK 351 135-641	403
33.430, 33.440 FDAS, FDALS, FDHS	316 - 324 kW		05/04→		Compressor, air conditioning BEHR	
33.430, 33.440 FDC, FDLC, FDRC, FDLRC, FDC/M	316 - 324 kW		05/04→		HELLA SERVICE	
33.430, 33.440 FDK, FDLK, FDRK	316 - 324 kW		05/04→		Version ALTERNATIVE	
33.430, 33.440 FDS, FDLs, FDRS, FDLRS, FDS/M	316 - 324 kW		05/04→		8FT 351 197-481	408
33.460 FDAC-WW	338 kW		09/02→	Depth [mm]: 65; L 307 mm; with expansion valve; Vers. produced by BEHR; W 200 mm	8FV 351 336-111	409
33.460 FDAK-WW	338 kW		09/02→		Evaporator, air conditioning	
33.460 FDAS-WW	338 kW		09/02→			
33.480 FDAC, FDALC, FDHC, FDHC/M	353 kW		02/06→	Diameter 1 [mm]: 18; Diameter 2 [mm]: 18; Diameter 3 [mm]: 10; Diameter 4 [mm]: 12; + OE 81.61967.0020; R 134a	8UW 351 336-161	410
33.480 FDAK, FDALK, FDHK	353 kW		02/06→		Expansion Valve, air conditioning	
33.480 FDAS, FDALS, FDHS	353 kW		02/06→			
33.480 FDC, FDLC, FDRC, FDC/M	353 kW		01/06→			
33.480 FDK, FDLK, FDRK	353 kW		01/06→			
33.480 FDS, FDRS, FDLs, FDS/M	353 kW		01/06→			
33.530 FDK, FDLK	390 kW		07/03→			
33.530 FDS, FDLs, FDLs/M, FDRS, FDLRS	390 kW		07/03→			
35.310, 35.320 FFDC, FFDLC	228 - 235 kW		02/04→			
35.310, 35.320 FFDK, FFDLK	228 - 235 kW		02/04→			
35.310, 35.320 FFD-TM	228 - 235 kW		02/04→			
35.310 FFDC, FFDLC	228 kW		06/03→			
35.310 FFDK, FFDLK	228 kW		06/03→			
35.350, 35.360 FFDC, FFDRC, FFDLC	257 - 265 kW		02/04→			
35.350, 35.360 FFDK, FFDRC, FFDLK	257 - 265 kW		02/04→			
35.350, 35.360 FFD-TM	257 - 265 kW		02/04→			
35.360 FFDC, FFDLC	265 kW		10/03→			
35.360 FFDK, FFDLK	265 kW		10/03→			
35.390, 35.400 FFDC, FFDRC, FFDLC	287 - 294 kW		02/04→			
35.390, 35.400 FFDK, FFDRC, FFDLK	287 - 294 kW		02/04→			
35.390, 35.400 FFD-TM	287 - 294 kW		02/04→			
35.410 FFDAK	301 kW		07/06→			
35.410 FFDC, FFDLC	301 kW		10/03→			
35.410 FFDK, FFDLK	301 kW		10/03→			
35.430, 35.440 FFDC, FFDRC, FFDLC	316 - 324 kW		02/04→			
35.430, 35.440 FFDK, FFDRC, FFDLK	316 - 324 kW		02/04→			
35.430, 35.440 FFD-TM	316 - 324 kW		02/04→			
35.460 FFDC, FFDLC	338 kW		10/03→			
35.460 FFDK, FFDLK	338 kW		10/03→			
35.480 FFDAK	353 kW		07/06→			
35.480 FFDC, FFDLC	353 kW		10/03→			
35.480 FFDK, FFDLK	353 kW		10/03→			
35.530 FFDAK	390 kW		07/06→			
35.530 FFDC, FFDLC	390 kW		04/04→			
35.530 FFDK, FFDLK	390 kW		04/04→			
37.310, 37.320 FFDC	228 - 235 kW		12/04→			
37.310, 37.320 FFDK	228 - 235 kW		12/04→			
37.310, 37.320 FFD-TM	228 - 235 kW		12/04→			
37.350, 37.360 FFDC	257 - 265 kW		12/04→			
37.350, 37.360 FFDK	257 - 265 kW		12/04→			
37.350, 37.360 FFD-TM	257 - 265 kW		12/04→			
37.390, 37.400 FFDC	287 - 294 kW		12/04→			
37.390, 37.400 FFDK	287 - 294 kW		12/04→			
37.390, 37.400 FFD-TM	287 - 294 kW		12/04→			
37.430, 37.440 FFDC	316 - 324 kW		12/04→			
37.430, 37.440 FFDK	316 - 324 kW		12/04→			
37.430, 37.440 FFD-TM	316 - 324 kW		12/04→			
40.390, 40.400 FDAK-WW	287 - 294 kW		06/05→			
40.390, 40.400 FDAS-WW	287 - 294 kW		06/05→			
40.410 FDAK-WW	301 kW		04/04→			
40.410 FDAS-WW	301 kW		04/04→			
40.410 FDK-WW	301 kW		04/04→			
40.410 FDS-WW	301 kW		04/04→			
40.430, 40.440 FDAK-WW	316 - 324 kW		06/05→			

Manufacturer - Model	Power	Displ.	Year of Constr.	Remark	Part Number	Page
MAN - TGA						04/00→
40.430, 40.440 FDAS-WW	316 - 324 kW		06/05→	Depth [mm]: 16; L 750 mm; without dehumidifier; Vers. produced by BEHR; W 351 mm	8FC 351 300-121	405
40.430 FDK-WW, FDRK	316 kW		06/05→		Condenser, air conditioning	
40.430 FDS-WW, FDRS	316 kW		06/05→	Compressor ID: SD7H15; Manufacturer Restriction: Sanden; New Part: 1; Number of Ribs: 8	8FK 351 135-141	402
40.460 FDAK-WW	338 kW		04/04→		Compressor, air conditioning	
40.460 FDAS-WW	338 kW		04/04→	Compressor ID: SD7H15; Manufacturer Restriction: Sanden; Number of Ribs: 8	8FK 351 135-641	403
40.460 FDK-WW	338 kW		04/04→		Compressor, air conditioning BEHR	
40.460 FDS-WW	338 kW		04/04→	HELLA SERVICE Version ALTERNATIVE		
40.480 FDAK-WW	353 kW		04/04→			
40.480 FDK-WW	353 kW		06/05→	HELLA SERVICE Version ALTERNATIVE		
40.480 FDAS-WW	353 kW		04/04→			
40.480 FDK-WW	353 kW		06/05→	HELLA SERVICE Version ALTERNATIVE		
40.480 FDS-WW	353 kW		04/04→			
41.350, 41.360 FFDC, FFDC/M, FFDRK	257 - 265 kW		12/04→	Depth [mm]: 65; L 307 mm; with expansion valve; Vers. produced by BEHR; W 200 mm	8FT 351 197-481	408
41.350, 41.360 FFDK, FFDRK	257 - 265 kW		12/04→		air conditioning	
41.350, 41.360 FFD-TM	257 - 265 kW		12/04→	Diameter 1 [mm]: 18; Diameter 2 [mm]: 18; Diameter 3 [mm]: 10; Diameter 4 [mm]: 12; + OE 81.61967.0020; R 134a	8FV 351 336-111	409
41.360 FFDK-WW	265 kW		09/03→		Evaporator, air conditioning	
41.390, 41.400 FFDC, FFDRK, FFDC/M	287 - 294 kW		12/04→	Diameter 1 [mm]: 18; Diameter 2 [mm]: 18; Diameter 3 [mm]: 10; Diameter 4 [mm]: 12; + OE 81.61967.0020; R 134a	8UW 351 336-161	410
41.390, 41.400 FFD-TM	287 - 294 kW		12/04→		Expansion Valve, air conditioning	
41.410 FFDK	301 kW		07/06→	Diameter 1 [mm]: 18; Diameter 2 [mm]: 18; Diameter 3 [mm]: 10; Diameter 4 [mm]: 12; + OE 81.61967.0020; R 134a		
41.410 FFDC-WW, FDRK	301 kW		09/03→			
41.410 FFDK-WW	301 kW		09/03→	Diameter 1 [mm]: 18; Diameter 2 [mm]: 18; Diameter 3 [mm]: 10; Diameter 4 [mm]: 12; + OE 81.61967.0020; R 134a		
41.430, 41.440 FFDC, FFDRK, FFDC/M	316 - 324 kW		12/04→			
41.430, 41.440 FFDK, FFDRK	316 - 324 kW		12/04→	Diameter 1 [mm]: 18; Diameter 2 [mm]: 18; Diameter 3 [mm]: 10; Diameter 4 [mm]: 12; + OE 81.61967.0020; R 134a		
41.430, 41.440 FFD-TM	316 - 324 kW		12/04→			
41.460 FFDC-WW, FFDRK	338 kW		09/03→	Diameter 1 [mm]: 18; Diameter 2 [mm]: 18; Diameter 3 [mm]: 10; Diameter 4 [mm]: 12; + OE 81.61967.0020; R 134a		
41.460 FFDK-WW	338 kW		09/03→			
41.480 FFDK	353 kW		07/06→	Diameter 1 [mm]: 18; Diameter 2 [mm]: 18; Diameter 3 [mm]: 10; Diameter 4 [mm]: 12; + OE 81.61967.0020; R 134a		
41.480 FFDC, FFDRK, FFDC/M	353 kW		02/06→			
41.480 FFDC-WW, FFDRK	353 kW		06/05→	Diameter 1 [mm]: 18; Diameter 2 [mm]: 18; Diameter 3 [mm]: 10; Diameter 4 [mm]: 12; + OE 81.61967.0020; R 134a		
41.480 FFDK, FFDRK	353 kW		02/06→			
41.480 FFDK-WW	353 kW		06/05→	Diameter 1 [mm]: 18; Diameter 2 [mm]: 18; Diameter 3 [mm]: 10; Diameter 4 [mm]: 12; + OE 81.61967.0020; R 134a		
41.480 FFD-TM	353 kW		02/06→			
41.530 FFDK	353 kW		07/06→	Diameter 1 [mm]: 18; Diameter 2 [mm]: 18; Diameter 3 [mm]: 10; Diameter 4 [mm]: 12; + OE 81.61967.0020; R 134a		
41.530 FFDK	390 kW		07/06→			
18.310, 18320 FC, FLC, FRC, FLLC, FLLC/N, FLLW, FLLRC, FLLRW	228 - 235 kW		04/00→	Depth [mm]: 16; L 750 mm; without dehumidifier; Vers. produced by BEHR; W 351 mm	8FC 351 300-121	405
18.310, 18320 FK, FLK, FK-L, FLRK	228 - 235 kW		12/00→		Condenser, air conditioning	
18.310 FAK, FAK-L, FALK	228 kW		09/02→	+ OE 51779707011 / + OE 51779707014; Compressor ID: SD7H15; Manufacturer Restriction: Sanden; New Part: 1; Number of Ribs: 2	8FK 351 119-361	401
18.310 FAS, FARS	228 kW		09/02→		Compressor, air conditioning	
18.310 FLS, FLLS, FLLS/N, FLS-TS, FLRS, FLLRS	228 kW		04/00→	Compressor ID: SD7H15; Manufacturer Restriction: Sanden; New Part: 1; Number of Ribs: 8	8FK 351 135-141	402
18.360 FAC, FARC	265 kW		09/02→		Compressor, air conditioning	
18.360 FAK, FALK, FAK-L, FALK-L	265 kW		09/02→	Compressor ID: SD7H15; Manufacturer Restriction: Sanden; Number of Ribs: 8	8FK 351 135-641	403
18.360 FAS, FALS, FARS	265 kW		09/02→		Compressor, air conditioning BEHR	
18.360 FC, FLC, FRC, FLLC, FLLC/N, FLLW, FLLRW	265 kW		04/00→	HELLA SERVICE Version ALTERNATIVE		
18.360 FK, FLK, FK-L, FLRK	265 kW		12/00→			
18.360 FLS, FLLS, FLLS/N, FLS-TS, FLRS, FLLRS	265 kW		04/00→	HELLA SERVICE Version ALTERNATIVE	8FT 351 197-481	408
18.410, 18420 FAK, FAK-L, FALK	301 - 309 kW		09/02→		air conditioning	
18.410, 18420 FC, FRC, FLC, FLRC, FLLC, FLLC/N, FLLW, FLLRC	301 - 309 kW		04/00→	Depth [mm]: 65; L 307 mm; with expansion valve; Vers. produced by BEHR; W 200 mm	8FV 351 336-111	409
18.410, 18420 FK, FK-L, FLK, FLRK	301 - 309 kW		12/00→		Evaporator, air conditioning	
18.410 FAC, FARC	301 kW		09/02→	-03/04; Diameter 1 [mm]: 18; Diameter 2 [mm]: 15; Diameter 3 [mm]: 10; Diameter 4 [mm]: 12; R 134a	8UW 351 239-381	410
18.410 FAS, FALS, FARS	301 kW		09/02→		Expansion Valve, air conditioning	
18.410 FLS, FLLS, FLLS/N, FLS-TS, FLRS, FLLRS	301 kW		04/00→	Diameter 1 [mm]: 18; Diameter 2 [mm]: 18; Diameter 3 [mm]: 10; Diameter 4 [mm]: 12; + OE 81.61967.0020; R 134a	8UW 351 336-161	410
18.460 FC, FLC, FRC, FLLC, FLLC/N, FLLW, FLLRC, FLLRW	338 kW		04/00→		Expansion Valve, air conditioning	
18.460 FK, FK-L, FLK, FLRK	338 kW		12/00→	Diameter 1 [mm]: 18; Diameter 2 [mm]: 18; Diameter 3 [mm]: 10; Diameter 4 [mm]: 12; + OE 81.61967.0020; R 134a		
18.460 FLS, FLLS, FLLS/N, FLS-TS, FLRS, FLLRS	338 kW		04/00→			
18.480 FAC, FARC	353 kW		09/02→	Diameter 1 [mm]: 18; Diameter 2 [mm]: 18; Diameter 3 [mm]: 10; Diameter 4 [mm]: 12; + OE 81.61967.0020; R 134a		
18.480 FAK, FAK-L, FALK	353 kW		09/02→			
18.480 FC, FLC, FLLC, FLLW, FLLRW, FLLRC	353 kW		09/02→	Diameter 1 [mm]: 18; Diameter 2 [mm]: 18; Diameter 3 [mm]: 10; Diameter 4 [mm]: 12; + OE 81.61967.0020; R 134a		
18.480 FK, FLK, FK-L	353 kW		09/02→			
18.480 FLS, FLLS, FLLS/N, FLS-TS, FLRS-WW	353 kW		09/02→	Diameter 1 [mm]: 18; Diameter 2 [mm]: 18; Diameter 3 [mm]: 10; Diameter 4 [mm]: 12; + OE 81.61967.0020; R 134a		
18.510 FC, FLC, FRC, FLLC, FLLC/N, FLLW, FLLRC, FLLRW	375 kW		09/00→			

Manufacturer - Model	Power	Displ.	Year of Constr.	Remark	Part Number	Page
MAN - TGA						04/00→
18.510 FLS, FLLS, FLLS/N, FLRS, FLLRS	375 kW		04/00→	Depth [mm]: 16; L 750 mm; without dehumidifier; Vers. produced by BEHR; W 351 mm	8FC 351 300-121 Condenser, air conditioning	405
18.530 FC, FLC, FLLC, FLLC/N, FLLW, FLLRC, FLLRW	390 kW		09/02→		+ OE 51779707011 / + OE 51779707014 ; Compressor ID: SD7H15; Manufacturer Restriction: Sanden; New Part: 1; Number of Ribs: 2	401
18.530 FLS, FLLS, FLLS/N	390 kW		09/02→		8FK 351 119-361 Compressor, air conditioning	
24.360 FNLLC/N, FNLLW, FNLLRW, FNLLRC	265 kW		09/01→		Compressor ID: SD7H15; Manufacturer Restriction: Sanden; New Part: 1; Number of Ribs: 8	402
24.410 FNLLC/N, FNLLW, FNLLRW	301 kW		09/01→		8FK 351 135-141 Compressor, air conditioning	
24.460 FNLLC/N, FNLLW, FNLLRC, FNLLRW	338 kW		09/01→		Compressor ID: SD7H15; Manufacturer Restriction: Sanden; Number of Ribs: 8	403
24.480 FNLLC/N, FNLLW, FNLLRC, FNLLRW	353 kW		09/02→		8FK 351 135-641 Compressor, air conditioning BEHR HELLA SERVICE Version ALTERNATIVE	
24.510 FNLLC/N, FNLLW, FNLLRW	375 kW		09/01→			
24.530 FNLLC/N, FNLLW, FNLLRW	390 kW		09/01→		8FT 351 197-481 Dryer, air conditioning	408
26.310 FDAC, FDARC	228 kW		02/02→	Depth [mm]: 65; L 307 mm; with expansion valve; Vers. produced by BEHR; W 200 mm	8FV 351 336-111 Evaporator, air conditioning	409
26.310 FDAK	228 kW		02/02→			
26.310 FDK, FDLK, FDRK	228 kW		09/02→			
26.310 FD-TM, FDR-TM	228 kW		10/00→			
26.310 FNLC, FNLLC, FVLC, FNLLW, FNLRC, FNLLRW	228 kW		09/00→		->03/04 ; Diameter 1 [mm]: 18; Diameter 2 [mm]: 15; Diameter 3 [mm]: 10; Diameter 4 [mm]: 12; R 134a	410
26.310 FPLS, FVLS, FNLS, FNLLS, FPLRS, FNLRS, FVLRS	228 kW		12/00→		8UW 351 239-381 Expansion Valve, air conditioning	
26.310 FVL-KO	228 kW		12/00→		8UW 351 336-161 Expansion Valve, air conditioning	410
26.360 FDAC, FDARC	265 kW		02/02→			
26.360 FDAK, FDALK	265 kW		02/02→			
26.360 FDAS, FDARS	265 kW		02/02→			
26.360 FDK, FDLK, FDRK, FDLRK	265 kW		09/02→			
26.360 FDS, FDLS, FNLS, FNLLS, FPLS, FPLRS, FVLS, FVLRS	265 kW		12/00→			
26.360 FNLC, FNLLC, FNLLW, FNLLRC, FNLLRW, FVLC	265 kW		09/00→			
26.360 FVL-KO	265 kW		12/00→			
26.410 FDAC, FDARC	301 kW		02/02→			
26.410 FDAS, FDALS, FDARS	301 kW		02/02→			
26.410 FDK, FDRK, FDLK, FDLRK	301 kW		09/01→			
26.410 FDS, FDLS, FDLRS, FDLRS-WW	301 kW		06/01→			
26.410 FNLC, FNLLC, FNLLW, FNLLRC, FNLLRW, FVLC	301 kW		04/00→			
26.410 FPLS, FPLRS, FVLS, FNLS, FNLLS	301 kW		12/00→			
26.410 FVL-KO	301 kW		12/00→			
26.460 FDS, FDLS, FDLRS, FDLRS-WW, FDLRS-WW	338 kW		06/01→			
26.460 FNLC, FNLRC, FNLLC, FNLLRW, FNLLRC	338 kW		04/00→			
26.460 FPLS, FPLRS, FVLS, FVLRS, FNLS, FNLLS, FNLRS	338 kW		12/00→			
26.460 FVLC	338 kW		02/01→			
26.460 FVL-KO	338 kW		12/00→			
26.480 FDAC, FDALC, FDARC	353 kW		09/02→			
26.480 FDAK, FDALK	353 kW		09/02→			
26.480 FDAS, FDALS, FDARS	353 kW		09/02→			
26.480 FDC, FDLC, FDRC, FDLRC, FDLRC-WW	353 kW		09/02→			
26.480 FDK, FDLK, FDLRK	353 kW		09/02→			
26.480 FDS, FDLS, FDLRS, FDLRS-WW, FDRS	353 kW		09/02→			
26.480 FD-TM	353 kW		09/02→			
26.480 FNLC, FNLLC, FVLC, FNLLRC, FVLLW	353 kW		09/02→			
26.480 FNLS, FNLLS, FNLRS, FPLS, FVLS	353 kW		09/02→			
26.480 FVL-KO	353 kW		09/02→			
26.510 FNLC, FNLLC, FNLLW, FNLLRC, FVLC	375 kW		12/00→			
26.510 FNLS, FNLLS, FNLRS, FPLS, FVLS	375 kW		12/00→			
26.530 FDK, FDLK, FDLRK	390 kW		09/02→			
26.530 FNLC, FNLLC, FNLLW, FNLLRC, FVLC, FVLRC	390 kW		09/02→			
26.530 FNLS, FNLLS, FNLRS, FPLS, FVLS, FVLRS	390 kW		09/02→			

Manufacturer - Model	Power	Displ.	Year of Constr.	Remark	Part Number	Page
MAN - TGA						04/00→
32.310 FFDK, FFDLK	228 kW		01/02→	Depth [mm]: 16; L 750 mm; without dehumidifier; Vers. produced by BEHR; W 351 mm	8FC 351 300-121	405
32.480 FFDK, FFDLK	353 kW		09/02→		Condenser, air conditioning	
32.480 FFD-TM	353 kW		09/02→	+ OE 51779707011 / + OE 51779707014; Compressor ID: SD7H15; Manufacturer Restriction: Sanden; New Part: 1; Number of Ribs: 2	8FK 351 119-361	401
33.360 FDAC, FDARC, FDAC-WW	265 kW		09/02→		Compressor, air conditioning	
33.360 FDAK, FDAK-WW	265 kW		09/02→	Compressor ID: SD7H15; Manufacturer Restriction: Sanden; New Part: 1; Number of Ribs: 8	8FK 351 135-141	402
33.360 FDAS, FDAS-WW	265 kW		09/02→		Compressor, air conditioning	
33.360 FDC, FDC-WW, FDLK/M, FDLRC	265 kW		10/00→	Compressor ID: SD7H15; Manufacturer Restriction: Sanden; Number of Ribs: 8	8FK 351 135-641	403
33.360 FDS, FDS-WW, FDLRS, FDLRS-WW	265 kW		10/00→		Compressor, air conditioning BEHR HELLA SERVICE Version ALTERNATIVE	
33.410 FDAC, FDAC-WW, FDALC	301 kW		09/02→		8FT 351 197-481	408
33.410 FDAK, FDAK-WW, FDALK	301 kW		09/02→		Dryer, air conditioning	
33.410 FDAS, FDAS-WW, FDALS	301 kW		09/02→	Depth [mm]: 65; L 307 mm; with expansion valve; Vers. produced by BEHR; W 200 mm	8FV 351 336-111	409
33.410 FDC, FDC-WW, FDLK, FDLRC, FDRK-WW	301 kW		10/00→		Evaporator, air conditioning	
33.410 FDK, FDK-WW, FDLK, FDRK-WW	301 kW		10/00→	→03/04; Diameter 1 [mm]: 18; Diameter 2 [mm]: 15; Diameter 3 [mm]: 10; Diameter 4 [mm]: 12; R 134a	8UW 351 239-381	410
33.410 FDS, FDS-WW, FDLRS, FDLRS-WW	301 kW		10/00→		Expansion Valve, air conditioning	
33.410 FD-TM, FDR-TM	301 kW		10/00→	Diameter 1 [mm]: 18; Diameter 2 [mm]: 18; Diameter 3 [mm]: 10; Diameter 4 [mm]: 12; + OE 81.61967.0020; R 134a	8UW 351 336-161	410
33.460 FDC, FDC-WW, FDLK, FDLRC, FDRK-WW	338 kW		09/02→		Expansion Valve, air conditioning	
33.460 FDK, FDK-WW, FDLK, FDRK-WW	338 kW		09/02→			
33.460 FDS, FDLRS, FDLRS-WW	338 kW		09/02→			
33.460 FD-TM, FDR-TM	338 kW		09/02→			
33.480 FDAC, FDAC-WW, FDALC, FDARC	353 kW		09/02→			
33.480 FDAK, FDAK-WW, FDALK	353 kW		09/02→			
33.480 FDAS, FDAS-WW, FDARS, FDALS	353 kW		09/02→			
33.480 FDC, FDC-WW, FDLK, FDLRC	353 kW		09/02→			
33.480 FDK, FDK-WW, FDLK, FDRK-WW	353 kW		09/02→			
33.480 FDS, FDS-WW, FDLRS, FDLRS-WW	353 kW		09/02→			
33.480 FD-TM	353 kW		09/02→			
33.510 FDC, FDC/M, FDLK, FDLRC	375 kW		09/02→			
33.510 FDS, FDLRS/M, FDLRS, FDLRS/M	375 kW		09/02→			
33.530 FDAK, FDALK	390 kW		09/02→			
33.530 FDAS, FDALS	390 kW		09/02→			
33.530 FDC, FDC/M, FDLK, FDLRC	390 kW		09/02→			
18.310 FAC, FARC	228 kW		09/02→	+ OE 51779707011 / + OE 51779707014; Compressor ID: SD7H15; Manufacturer Restriction: Sanden; New Part: 1; Number of Ribs: 2	8FK 351 119-361	401
				→03/04; Diameter 1 [mm]: 18; Diameter 2 [mm]: 15; Diameter 3 [mm]: 10; Diameter 4 [mm]: 12; R 134a	8UW 351 239-381	410
					Expansion Valve, air conditioning	
				Diameter 1 [mm]: 18; Diameter 2 [mm]: 18; Diameter 3 [mm]: 10; Diameter 4 [mm]: 12; + OE 81.61967.0020; R 134a	8UW 351 336-161	410
					Expansion Valve, air conditioning	
18.360 FLS, FLLS, FLRS, FLLRS	265 kW		01/06→	Depth [mm]: 16; L 750 mm; without dehumidifier; Vers. produced by BEHR; W 351 mm	8FC 351 300-121	405
18.400 FLS, FLLS, FLRS, FLLRS	294 kW		10/05→		Condenser, air conditioning	
18.440 FLS, FLLS, FLRS, FLLRS	324 kW		09/05→	Compressor ID: SD7H15; Manufacturer Restriction: Sanden; New Part: 1; Number of Ribs: 8	8FK 351 135-141	402
18.480 FAC	353 kW		02/06→		Compressor, air conditioning	
18.480 FAK, FALK	353 kW		02/06→	Compressor ID: SD7H15; Manufacturer Restriction: Sanden; Number of Ribs: 8	8FK 351 135-641	403
18.480 FAS, FALS	353 kW		02/06→		Compressor, air conditioning BEHR HELLA SERVICE Version ALTERNATIVE	
18.480 FLS, FLLS, FLRS, FLLRS	353 kW		01/06→			
18.530 FAC	390 kW		04/04→			
18.530 FAK, FALK	390 kW		04/04→			
18.530 FAS, FALS	390 kW		04/04→			
18.540 FLC, FLRC, FLLC, FLLRC, FLLW	397 kW		08/06→			
18.540 FLS, FLRS, FLLS, FLLRS	397 kW		05/04→			
19.350 FS, FRS, FLS, FLRS-WW	257 kW		05/04→	Depth [mm]: 65; L 307 mm; with expansion valve; Vers. produced by BEHR; W 200 mm	8FV 351 336-111	409
19.360 FS, FRS, FLS, FLRS-WW	265 kW		05/04→		Evaporator, air conditioning	
19.390 FS, FRS, FLS, FLRS-WW	287 kW		05/04→			
19.430 FS/M-WW, FLS, FRS, FLRS	316 kW		05/04→			

Manufacturer - Model	Power	Displ.	Year of Constr.	Remark	Part Number	Page
MAN - TGA						04/00→
19.440 FRS, FS/M-WW, FLS, FLRS	324 kW		02/06→	Depth [mm]: 16; L 750 mm; without dehumidifier; Vers. produced by BEHR; W 351 mm	8FC 351 300-121	405
19.480 FLS, FRS, FLRS-WW	353 kW		02/06→		Condenser, air conditioning	
19.480 FS/M, FRS/M-WW	353 kW		02/06→	Compressor ID: SD7H15; Manufacturer Restriction: Sanden; New Part: 1; Number of Ribs: 8	8FK 351 135-141	402
24.480 FPLS, FPLRS	353 kW		07/05→		Compressor, air conditioning	
24.530 FPLS, FPLRS	390 kW		07/05→	Compressor ID: SD7H15; Manufacturer Restriction: Sanden; Number of Ribs: 8	8FK 351 135-641	403
26.310 FDAC	228 kW		01/04→		Compressor, air conditioning BEHR	
26.310 FDAK	228 kW		01/04→	HELLA SERVICE		
26.310 FDAS	228 kW		01/04→		Version ALTERNATIVE	
26.320 FDAC	235 kW		04/06→	HELLA SERVICE		
26.320 FDAK	235 kW		04/06→		Version ALTERNATIVE	
26.320 FDAS	235 kW		04/06→	HELLA SERVICE		
26.350 FDAC	257 kW		02/04→		8FT 351 197-481	Dryer, 408
26.350 FDAK	257 kW		02/04→	air conditioning		
26.350 FDAS	257 kW		02/04→		8FV 351 336-111	409
26.350 FDLRC-WW	257 kW		05/04→	Depth [mm]: 65; L 307 mm; with expansion valve; Vers. produced by BEHR; W 200 mm	Evaporator, air conditioning	
26.350 FDLRS, FDLRS/M, FDLRS-WW	257 kW		05/04→			
26.350 FVHLC	257 kW		06/05→			
26.350 FVHLS	257 kW		07/05→			
26.350 FVLC	257 kW		01/04→			
26.350 FVLS, FVLRS	257 kW		07/05→			
26.360 FDAC, FDARC	265 kW		06/04→			
26.360 FDAK, FDARK	265 kW		06/04→			
26.360 FDAS, FDARS	265 kW		06/04→			
26.360 FDHC, FDHLC	265 kW		05/04→			
26.360 FDLRC-WW, FDLRC	265 kW		05/04→			
26.360 FDLRS, FDLRS-WW, FNHLS	265 kW		05/04→			
26.360 FVHLC	265 kW		04/06→			
26.360 FVHLS	265 kW		04/06→			
26.360 FVLC	265 kW		04/06→			
26.360 FVLS, FVLRS	265 kW		04/06→			
26.390 FDAC, FDALC	287 kW		01/04→			
26.390 FDAK, FDALK	287 kW		02/04→			
26.390 FDAS, FDALS	287 kW		02/04→			
26.390 FDH-TM	287 kW		06/05→			
26.390 FVLC	287 kW		02/04→			
26.390 FVLS, FVLRS	287 kW		07/05→			
26.400 FDAC, FDALC	294 kW		01/04→			
26.400 FDAK, FDALK	294 kW		01/04→			
26.400 FDAS, FDALS	294 kW		01/04→			
26.400 FDH-TM	294 kW		04/06→			
26.400 FVLC	294 kW		04/06→			
26.400 FVLS, FVLRS	294 kW		04/06→			
26.430 FDAC, FDALC	316 kW		01/04→			
26.430 FDAK, FDALK	316 kW		01/04→			
26.430 FDAS, FDALS	316 kW		01/04→			
26.430 FDLRS, FDLRS/M, FDLRS-WW	316 - 324 kW		02/04→			
26.430 FVL-KO	316 kW		12/00→			
26.430 FVLS, FVLRS	316 kW		07/05→			
26.440 FDAC, FDALC	324 kW		09/05→			
26.440 FDAK, FDALK	324 kW		01/04→			
26.440 FDAS, FDALS	324 kW		01/04→			
26.440 FDLRC-WW, FDLRC-WW	324 kW		02/06→			
26.440 FDS, FDLRS, FDLRS-WW, FDLRS-WW	324 kW		02/06→			
26.440 FVL-KO	324 kW		09/05→			
26.440 FVLS, FVLRS	324 kW		09/05→			
26.480 FDAC, FDALC	353 kW		02/06→			
26.480 FDAK, FDALK	353 kW		02/06→			
26.480 FDAS, FDALS	353 kW		02/06→			
26.480 FVL-KO	353 kW		01/06→			
26.540 FNLC, FNLLC, FNLLRC, FNLLW	397 kW		08/06→			
28.310 FNLS, FNLRS	228 kW		06/04→			
28.320 FNLC, FNLLC, FNLRC	235 kW		06/04→			
28.320 FNLS, FNLRS	235 kW		06/04→			
28.350 FANLC	257 kW		07/06→			
28.350 FANLK	257 kW		07/06→			
28.350 FNLS, FNLRS-WW	257 kW		02/04→			
28.360 FNLS, FNLRS-WW	265 kW		04/06→			
28.390 FANLC	287 kW		07/06→			
28.390 FANLK	287 kW		07/06→			
28.390 FNLS, FNLRS	287 kW		05/04→			
28.400 FANLC	294 kW		07/06→			
28.400 FANLK	294 kW		07/06→			
28.400 FNLS, FNLRS	294 kW		04/06→			
28.430 FANLC	316 kW		07/06→			
28.430 FANLK	316 kW		07/06→			

Manufacturer - Model	Power	Displ.	Year of Constr.	Remark	Part Number	Page
MAN - TGA						04/00→
28.430 FNLS, FNLRW-WW	316 kW		05/04→	Depth [mm]: 16; L 750 mm; without dehumidifier; Vers. produced by BEHR; W 351 mm	8FC 351 300-121	405
28.440 FANLC	324 kW		07/06→		Condenser, air conditioning	
28.440 FANLK	324 kW		07/06→	Compressor ID: SD7H15; Manufacturer Restriction: Sanden; New Part: 1; Number of Ribs: 8	8FK 351 135-141	402
28.440 FNLS, FNLRW-WW	324 kW		09/05→		Compressor, air conditioning	
28.480 FANLC	353 kW		07/06→	Compressor ID: SD7H15; Manufacturer Restriction: Sanden; Number of Ribs: 8	8FK 351 135-641	403
28.480 FNLC, FNLRW-WW, FNLLC	353 kW		02/06→		Compressor, air conditioning BEHR	
28.480 FNLS, FNLRW-WW	353 kW		02/06→	Compressor ID: SD7H15; Manufacturer Restriction: Sanden; Number of Ribs: 8	8FK 351 135-641	403
28.540 FNLC, FNLLC	397 kW		08/06→		HELLA SERVICE	
28.540 FNLS	397 kW		08/06→	Version ALTERNATIVE	8FT 351 197-481	408
33.350 FDC-TM, FDRW-TM	257 kW		09/07→		Dryer, air conditioning	
33.360 FDC-TM, FDRW-TM	265 kW		09/07→	Depth [mm]: 65; L 307 mm; with expansion valve; Vers. produced by BEHR; W 200 mm	8FV 351 336-111	409
33.390, 33.400 FDC-TM, FDRW-TM	287 - 294 kW		09/07→		Evaporator, air conditioning	
33.440 FDAC, FDHC	324 kW		06/05→	Depth [mm]: 65; L 307 mm; with expansion valve; Vers. produced by BEHR; W 200 mm	8FV 351 336-111	409
33.440 FDAK, FDHK	324 kW		06/05→		Evaporator, air conditioning	
33.440 FDAS, FDHS	324 kW		06/05→			
33.440 FDC, FDRW	324 kW		06/05→			
33.440 FDC-TM, FDRW-TM	324 kW		09/07→			
33.440 FDK, FDRK	324 kW		06/05→			
33.440 FDS, FDRS	324 kW		06/05→			
33.480 FDC-TM, FDRW-TM	353 kW		09/07→			
33.530 FDAC, FDALC	390 kW		09/02→			
35.350 FFDHK, FFDHLK	257 kW		07/06→			
35.350 FFDH-TM	257 kW		07/06→			
35.350 FFNLC	257 kW		07/06→			
35.360 FFDHK, FFDHLK	265 kW		07/06→			
35.360 FFDH-TM	265 kW		07/06→			
35.360 FFNHLC	265 kW		07/06→			
35.390 FDNLC	287 kW		07/06→			
35.390 FFDAK	287 kW		02/04→			
35.390 FFDAK, FFDHK, FFDHLK	287 kW		07/06→			
35.390 FFDH-TM	287 kW		07/06→			
35.400 FDNLC	294 kW		07/06→			
35.400 FFDAK	294 kW		02/04→			
35.400 FFDAK, FFDHK, FFDHLK	294 kW		07/06→			
35.400 FFDH-TM	294 kW		07/06→			
35.400 FFNHLC	294 kW		11/06→			
35.400 FFNLC	294 kW		07/06→			
35.430 FDNLC	316 kW		07/06→			
35.430 FFDAK, FFDHK, FFDHLK	316 kW		07/06→			
35.430 FFDH-TM	316 kW		07/06→			
35.430 FFNLC	316 kW		07/06→			
35.440 FDNLC	324 kW		07/06→			
35.440 FFDAK, FFDHK, FFDHLK	324 kW		07/06→			
35.440 FFDH-TM	324 kW		07/06→			
35.440 FFNHLC	324 kW		11/06→			
35.440 FFNLC	324 kW		07/06→			
35.480 FDNLC	353 kW		07/06→			
35.480 FFDAK, FFDHK, FFDHLK	353 kW		07/06→			
35.480 FFDARS	353 kW		07/06→			
35.480 FFDH-TM	353 kW		07/06→			
35.480 FFD-TM	353 kW		11/03→			
35.480 FFNHLC	353 kW		11/06→			
35.480 FFNLC	353 kW		07/06→			
35.530 FDNLC	390 kW		04/04→			
35.530 FFD-TM	390 kW		04/04→			
35.530 FFNLC	390 kW		07/06→			
37.480 FFDC	353 kW		12/04→			
37.480 FFDK	353 kW		12/04→			
37.480 FFD-TM	353 kW		12/04→			
37.530 FFDC	390 kW		12/04→			
37.530 FFDK	390 kW		12/04→			
37.530 FFD-TM	390 kW		12/04→			
37.530 FVDS, FVDLS	390 kW		07/06→			
39.390 FVNLC	287 kW		07/06→			
39.400 FVNLC	294 kW		07/06→			
39.430 FVNLC	316 kW		07/06→			
39.440 FVNLC	324 kW		07/06→			
39.480 FVNLC	353 kW		07/06→			
40.440 FDAK-WW	324 kW		06/05→			
40.440 FDAS-WW	324 kW		06/05→			
40.440 FDK-WW, FDRK	324 kW		06/05→			
40.440 FDS-WW, FDRS	324 kW		06/05→			
40.480 FDK-WW, FDRK	353 kW		06/05→			
40.480 FDS-WW; FDRS	353 kW		06/05→			
41.350 FFDC-TM, FFDRC-TM	257 kW		09/07→			
41.360 FFD	265 kW		12/08→			
41.360 FFDC-TM, FDRW-TM	265 kW		09/07→			
41.390 FFDAK	287 kW		12/04→			
41.390 FFDC-TM, FDRW-TM	287 kW		09/07→			

Manufacturer - Model	Power	Displ.	Year of Constr.	Remark	Part Number	Page		
MAN - TGA						04/00→		
41.430 FFDAK	316 kW		12/04→	Depth [mm]: 16; L 750 mm; without dehumidifier; Vers. produced by BEHR; W 351 mm	8FC 351 300-121	405		
41.430 FFDAK	316 kW		07/06→		Compressor ID: SD7H15; Manufacturer Restriction: Sanden; New Part: 1; Number of Ribs: 8	Condenser, air conditioning		
41.430 FFDC-TM, FFDRC	316 kW		09/07→			8FK 351 135-141	402	
41.440 FFD/M	324 kW		12/04→		Compressor ID: SD7H15; Manufacturer Restriction: Sanden; Number of Ribs: 8	Compressor, air conditioning		
41.440 FFDAK	324 kW		07/06→			8FK 351 135-641	403	
41.440 FFDC, FFDRC	324 kW		12/04→			Compressor, air conditioning BEHR HELLA SERVICE Version ALTERNATIVE		
41.440 FFDC-TM, FFDRC-TM	324 kW		09/07→		Depth [mm]: 65; L 307 mm; with expansion valve; Vers. produced by BEHR; W 200 mm	8FT 351 197-481	408	
41.440 FFDK, FFDRK	324 kW		12/04→			air conditioning		
41.480 FFD	353 kW		12/08→			8FV 351 336-111	409	
41.480 FFDARC	353 kW		07/06→			Evaporator, air conditioning		
41.480 FFDC-TM, FFDRC-TM	353 kW		09/07→			--03/04; Diameter 1 [mm]: 18; Diameter 2 [mm]: 15; Diameter 3 [mm]: 10; Diameter 4 [mm]: 12; R 134a	8UW 351 239-381	410
41.480 FFD-TM	353 kW		12/04→				Expansion Valve, air conditioning	
41.480 FVDS, FVDLS	353 kW		07/06→				8UW 351 336-161	410
41.530 FFDC	390 kW		12/04→				Expansion Valve, air conditioning	
41.530 FFDK	390 kW		12/04→		Diameter 1 [mm]: 18; Diameter 2 [mm]: 18; Diameter 3 [mm]: 10; Diameter 4 [mm]: 12; + OE 81.61967.0020; R 134a		8UW 351 336-161	410
41.540 FVDS, FVDLS	397 kW		11/06→				Expansion Valve, air conditioning	
18.480 FAS, FALS, FARS	353 kW		09/02→		Diameter 1 [mm]: 18; Diameter 2 [mm]: 18; Diameter 3 [mm]: 10; Diameter 4 [mm]: 12; + OE 81.61967.0020; R 134a	8FC 351 300-121	405	
26.410 FDAK, FDALK	301 kW		02/02→	Condenser, air conditioning				
				Compressor ID: SD7H15; Manufacturer Restriction: Sanden; New Part: 1; Number of Ribs: 8		8FK 351 135-141	402	
						Compressor, air conditioning		
				Compressor ID: SD7H15; Manufacturer Restriction: Sanden; Number of Ribs: 8		8FK 351 135-641	403	
						Compressor, air conditioning BEHR HELLA SERVICE Version ALTERNATIVE		
						8FT 351 197-481	408	
				Dryer, air conditioning				
				Depth [mm]: 65; L 307 mm; with expansion valve; Vers. produced by BEHR; W 200 mm		8FV 351 336-111	409	
						Evaporator, air conditioning		
				Diameter 1 [mm]: 18; Diameter 2 [mm]: 18; Diameter 3 [mm]: 10; Diameter 4 [mm]: 12; + OE 81.61967.0020; R 134a		8UW 351 239-381	410	
						Expansion Valve, air conditioning		
				Diameter 1 [mm]: 18; Diameter 2 [mm]: 18; Diameter 3 [mm]: 10; Diameter 4 [mm]: 12; + OE 81.61967.0020; R 134a		8UW 351 336-161	410	
						Expansion Valve, air conditioning		
18.480 FHLS, FHLS/M	353 kW		04/06→	Diameter 1 [mm]: 18; Diameter 2 [mm]: 18; Diameter 3 [mm]: 10; Diameter 4 [mm]: 12; + OE 81.61967.0020; R 134a		8UW 351 336-161	410	
18.480 FK, FK-L, FLK	353 kW		01/06→			Expansion Valve, air conditioning		
24.480 FNLLC/N, FNLLW/N	353 kW		01/06→					
24.480 FPLS, FPLRS	353 kW		01/06→					
24.540 FNLLC/N, FLLCW/N	397 kW		01/06→					
26.480 FDHC, FDHC/M, FDHLC	353 kW		02/06→					
26.480 FDHS, FDHS/M, FDHLS	353 kW		02/06→					
26.480 FDH-TM	353 kW		02/06→					
26.480 FDK, FDLK	353 kW		02/06→					
26.480 FD-TM	353 kW		02/06→					
26.480 FNLC, FNLC-WW, FNLLC, FNLLRC, FNLLW, FVLC	353 kW		02/06→					
26.480 FNLS, FNLLS, FNLS, FPLS, FVLS, FVLS	353 kW		02/06→					
26.480 FVHL-KO	353 kW		02/06→					
32.480 FFDRC	353 kW		02/06→					
32.480 FFD-TM, FFDR-TM	353 kW		02/06→					
35.480 FFDC, FFDLC	353 kW		02/04→					
35.480 FFDK, FFDLK	353 kW		02/04→					
35.480 FFD-TM	353 kW		02/04→					
37.480 FFDC	353 kW		02/06→					
37.480 FFDK	353 kW		02/06→					
37.480 FFD-TM	353 kW		02/06→					
40.390, 40.400 FDK-WW, FDRK	287 - 294 kW		06/05→					
40.390, 40.400 FDS-WW, FDRS	287 - 294 kW		06/05→					
41.660 FVDS, FVDLS	485 kW		09/02→					
26.280 FNLC, FNLLC, FNLLW	206 kW		11/02→		Depth [mm]: 16; L 750 mm; without dehumidifier; Vers. produced by BEHR; W 351 mm	8FC 351 300-121	405	
						Condenser, air conditioning		
						Compressor ID: SD7H15; Manufacturer Restriction: Sanden; New Part: 1; Number of Ribs: 8	8FK 351 135-141	402
							Compressor, air conditioning	
					Compressor ID: SD7H15; Manufacturer Restriction: Sanden; New Part: 1; Number of Ribs: 8	8FK 351 135-231	402	
						Compressor, air conditioning		
					Compressor ID: SD7H15; Manufacturer Restriction: Sanden; Number of Ribs: 8	8FK 351 135-641	403	
						Compressor, air conditioning BEHR HELLA SERVICE Version ALTERNATIVE		

Manufacturer - Model	Power	Displ.	Year of Constr.	Remark	Part Number	Page
MAN - TGA						04/00→
26.280 FNLC, FNLLC, FNLLW	206 kW		11/02→		8FT 351 197-481 Dryer, 408 air conditioning	408
				Depth [mm]: 65; L 307 mm; with expansion valve; Vers. produced by BEHR; W 200 mm	8FV 351 336-111 Evaporator, air conditioning	409
				Diameter 1 [mm]: 18; Diameter 2 [mm]: 18; Diameter 3 [mm]: 10; Diameter 4 [mm]: 12; + OE 81.61967.0020; R 134a	8UW 351 336-161 Expansion Valve, air conditioning	410
26.310 FDAS, FDARS	228 kW		02/02→	Depth [mm]: 16; L 750 mm; without dehumidifier; Vers. produced by BEHR; W 351 mm	8FC 351 300-121 Condenser, air conditioning	405
				+ OE 51779707011 / + OE 51779707014; Compressor ID: SD7H15; Manufacturer Restriction: Sanden; New Part: 1; Number of Ribs: 2	8FK 351 119-361 Compressor, air conditioning	401
				Compressor ID: SD7H15; Manufacturer Restriction: Sanden; New Part: 1; Number of Ribs: 8	8FK 351 135-141 Compressor, air conditioning	402
				Compressor ID: SD7H15; Manufacturer Restriction: Sanden; Number of Ribs: 8	8FK 351 135-641 Compressor, air conditioning BEHR HELLA SERVICE Version ALTERNATIVE	403
					8FT 351 197-481 Dryer, 408 air conditioning	408
				Depth [mm]: 65; L 307 mm; with expansion valve; Vers. produced by BEHR; W 200 mm	8FV 351 336-111 Evaporator, air conditioning	409
				→03/04; Diameter 1 [mm]: 18; Diameter 2 [mm]: 15; Diameter 3 [mm]: 10; Diameter 4 [mm]: 12; R 134a	8UW 351 239-381 Expansion Valve, air conditioning	410
26.310 FDC, FDLC, FDRC, FDLC/M, FDLRC	228 kW		01/01→	Depth [mm]: 16; L 750 mm; without dehumidifier; Vers. produced by BEHR; W 351 mm	8FC 351 300-121 Condenser, air conditioning	405
26.310 FDS, FDLS, FDLS/M, FDLRS	228 kW		01/01→		+ OE 51779707011 / + OE 51779707014; Compressor ID: SD7H15; Manufacturer Restriction: Sanden; New Part: 1; Number of Ribs: 2	401
26.360 FDC, FDLC, FDLC/M, FDRC, FDLRC-WW	265 kW		01/01→		Compressor ID: SD7H15; Manufacturer Restriction: Sanden; New Part: 1; Number of Ribs: 8	402
26.360 FD-TM, FDR-TM	265 kW		01/01→		Compressor ID: SD7H15; Manufacturer Restriction: Sanden; Number of Ribs: 8	403
26.410 FDC, FDLC, FDLC/M, FDLC-WW; FDRC-WW, FDLRC-WW	301 kW		01/01→			408
26.410 FD-TM, FDR-TM	301 kW		01/01→			409
26.460 FDC, FDLC, FDLC/M, FDLC-WW, FDRC, FDLRC-WW	338 kW		01/01→			409
26.460 FDK, FDLK, FDLRK	338 kW		01/01→			408
26.460 FD-TM, FDR-TM	338 kW		01/01→			409
26.510 FDC, FDC/M, FDRC, FDLC, FDLC/M, FDLRC	375 kW		01/01→			409
26.510 FDS, FDLS, FDLS/M, FDRS, FDLRS	375 kW		01/01→	Depth [mm]: 67; L 385 mm; with expansion valve; Vers. produced by BEHR; W 203 mm	8FV 351 330-111 Evaporator, air conditioning	409
26.530 FDC, FDLC, FDC/M, FDLRC	390 kW		01/01→			409
26.530 FDS, FDLS, FDLS/M, FDLRS	390 kW		01/01→			410
32.310 FFDLC, FFDLRC	228 kW		01/02→			410
32.310 FFD-TM	228 kW		01/02→			410
32.360 FFDLC, FFDLRC	265 kW		01/02→			410
32.360 FFDK, FFDLK	265 kW		01/02→			410
32.360 FFD-TM	265 kW		01/02→			410
32.410 FFDK, FFDLK	301 kW		01/02→			410
32.410 FFD-TM	301 kW		01/02→			410
32.460 FFDLC, FFDLRC	338 kW		01/02→			410
32.460 FFDK, FFDLK	338 kW		01/02→			410
32.460 FFD-TM	338 kW		01/02→			410
33.360 FDK, FDK-WW, FDLK, FDRK-WW	265 kW		01/01→			410
33.360 FD-TM, FDR-TM	265 kW		01/01→			410
41.360 FFDLC, FFDLC/M, FFDLC-WW, FFDLRC	265 kW		01/03→			410
26.310 FVLC	228 kW		09/03→	Depth [mm]: 16; L 750 mm; without dehumidifier; Vers. produced by BEHR; W 351 mm	8FC 351 300-121 Condenser, air conditioning	405
26.410 FVLC	301 kW		09/03→			401
26.410 FVLS, FVLR	301 kW		07/05→			401
28.310 FNLC, FNLLC	228 kW		09/02→			401
28.410 FNLC, FNLLC	301 kW		09/02→	Compressor ID: SD7H15; Manufacturer Restriction: Sanden; New Part: 1; Number of Ribs: 2	8FK 351 119-361 Compressor, air conditioning	401
35.310 FFD-TM	228 kW		11/03→			402
35.360 FFD-TM	265 kW		11/03→			402
35.360 FFNLC	265 kW		07/06→	Compressor ID: SD7H15; Manufacturer Restriction: Sanden; New Part: 1; Number of Ribs: 8	8FK 351 135-141 Compressor, air conditioning	402
35.410 FDNLC	301 kW		07/06→			
35.410 FFD-TM	301 kW		11/03→			
35.410 FFNLC	301 kW		07/06→			

Manufacturer - Model	Power	Displ.	Year of Constr.	Remark	Part Number	Page
MAN - TGA						04/00→
35.460 FFD-TM	338 kW		11/03→	Compressor ID: SD7H15; Manufacturer Restriction: Sanden; Number of Ribs: 8	8FK 351 135-641	403
35.460 FFNLC	338 kW		07/06→		Compressor, air conditioning BEHR	
37.310 FFDC	228 kW		12/04→		HELLA SERVICE	
37.310 FFDK	228 kW		12/04→		Version ALTERNATIVE	
37.310 FFD-TM	228 kW		12/04→			
37.360 FFDC	265 kW		12/04→		8FT 351 197-481 Dryer, 408	
37.360 FFDK	265 kW		12/04→		air conditioning	
37.360 FFD-TM	265 kW		12/04→			
37.410 FFDC	301 kW		12/04→		Depth [mm]: 65; L 307 mm; with expansion valve; Vers. produced by BEHR; W 200 mm	
37.410 FFDK	301 kW		12/04→		8FV 351 336-111	409
37.410 FFD-TM	301 kW		12/04→		Evaporator, air conditioning	
37.460 FFDC	338 kW		12/04→			
37.460 FFDK	338 kW		12/04→			
37.460 FFD-TM	338 kW		12/04→			
41.360 FFD-TM	265 kW		12/04→			
41.410 FFD-TM	301 kW		12/04→			
41.460 FFD-TM	338 kW		12/04→			
26.330 FNLC, FNLLC, FNLLW	240 kW		11/02→	Compressor ID: SD7H15; Manufacturer Restriction: Sanden; New Part: 1; Number of Ribs: 8	8FK 351 135-141	402
				Compressor, air conditioning		
				Compressor ID: SD7H15; Manufacturer Restriction: Sanden; New Part: 1; Number of Ribs: 8	8FK 351 135-231	402
				Compressor, air conditioning		
				Compressor ID: SD7H15; Manufacturer Restriction: Sanden; Number of Ribs: 8	8FK 351 135-641	403
				Compressor, air conditioning BEHR		
				HELLA SERVICE		
				Version ALTERNATIVE		
				Depth [mm]: 65; L 307 mm; with expansion valve; Vers. produced by BEHR; W 200 mm	8FV 351 336-111	409
				Evaporator, air conditioning		
				Diameter 1 [mm]: 18; Diameter 2 [mm]: 18; Diameter 3 [mm]: 10; Diameter 4 [mm]: 12; + OE 81.61967.0020; R 134a	8UW 351 336-161	410
				Expansion Valve, air conditioning		
28.310 FNLC, FNLLC, FNLR	228 kW		09/02→	Depth [mm]: 16; L 750 mm; without dehumidifier; Vers. produced by BEHR; W 351 mm	8FC 351 300-121	405
28.310 FNLS, FNLR	228 kW		09/02→	Condenser, air conditioning		
28.360 FNLS, FNLR	265 kW		09/02→			
28.410 FNLC, FNLLC, FNLR	301 kW		09/02→	+ OE 51779707011 / + OE 51779707014; Compressor ID: SD7H15; Manufacturer Restriction: Sanden; New Part: 1; Number of Ribs: 2	8FK 351 119-361	401
28.410 FNLS, FNLR	301 kW		09/02→	Compressor, air conditioning		
28.460 FNLC, FNLLC, FNLR	338 kW		09/02→	Compressor ID: SD7H15; Manufacturer Restriction: Sanden; New Part: 1; Number of Ribs: 8	8FK 351 135-141	402
28.460 FNLS, FNLR	338 kW		09/02→	Compressor, air conditioning		
28.480 FNLC, FNLLC, FNLR	353 kW		09/02→	Compressor ID: SD7H15; Manufacturer Restriction: Sanden; Number of Ribs: 8	8FK 351 135-641	403
28.480 FNLS, FNLR	353 kW		09/02→	Compressor, air conditioning BEHR		
28.510 FNLC, FNLLC, FNLR	375 kW		09/02→	HELLA SERVICE		
28.510 FNLS, FNLR	375 kW		09/02→	Version ALTERNATIVE		
28.530 FNLC, FNLLC, FNLR	390 kW		09/02→			
28.530 FNLS, FNLR	390 kW		09/02→			
32.480 FFDC, FFDLC, FFDLRC	353 kW		09/02→			
41.530 FVDS, FVDLS	390 kW		09/02→			
					8FT 351 197-481 Dryer, 408	air conditioning
				Depth [mm]: 65; L 307 mm; with expansion valve; Vers. produced by BEHR; W 200 mm	8FV 351 336-111	409
				Evaporator, air conditioning		
				Diameter 1 [mm]: 18; Diameter 2 [mm]: 18; Diameter 3 [mm]: 10; Diameter 4 [mm]: 12; + OE 81.61967.0020; R 134a	8UW 351 336-161	410
				Expansion Valve, air conditioning		
28.360 FANLK	265 kW		07/06→	Depth [mm]: 16; L 750 mm; without dehumidifier; Vers. produced by BEHR; W 351 mm	8FC 351 300-121	405
				Condenser, air conditioning		
				Compressor ID: SD7H15; Manufacturer Restriction: Sanden; New Part: 1; Number of Ribs: 2	8FK 351 119-361	401
				Compressor, air conditioning		
				Compressor ID: SD7H15; Manufacturer Restriction: Sanden; New Part: 1; Number of Ribs: 8	8FK 351 135-141	402
				Compressor, air conditioning		
				Compressor ID: SD7H15; Manufacturer Restriction: Sanden; Number of Ribs: 8	8FK 351 135-641	403
				Compressor, air conditioning BEHR		
				HELLA SERVICE		
				Version ALTERNATIVE		
					8FT 351 197-481 Dryer, 408	air conditioning
				Depth [mm]: 65; L 307 mm; with expansion valve; Vers. produced by BEHR; W 200 mm	8FV 351 336-111	409
				Evaporator, air conditioning		

Manufacturer - Model	Power	Displ.	Year of Constr.	Remark	Part Number	Page							
MAN - TGA						04/00→							
28.360 FANLK	265 kW		07/06→	Diameter 1 [mm]: 18; Diameter 2 [mm]: 18; Diameter 3 [mm]: 10; Diameter 4 [mm]: 12; + OE 81.61967.0020; R 134a	8UW 351 336-161 Expansion Valve, air conditioning	410							
28.360 FNLC, FNLLC	265 kW		09/02→	Depth [mm]: 16; L 750 mm; without dehumidifier; Vers. produced by BEHR; W 351 mm	8FC 351 300-121 Condenser, air conditioning	405							
				+ OE 51779707011 / + OE 51779707014; Compressor ID: SD7H15; Manufacturer Restriction: Sanden; New Part: 1; Number of Ribs: 2	8FK 351 119-361 Compressor, air conditioning	401							
				Compressor ID: SD7H15; Manufacturer Restriction: Sanden; New Part: 1; Number of Ribs: 2	8FK 351 119-361 Compressor, air conditioning	401							
				Compressor ID: SD7H15; Manufacturer Restriction: Sanden; New Part: 1; Number of Ribs: 8	8FK 351 135-141 Compressor, air conditioning	402							
				Compressor ID: SD7H15; Manufacturer Restriction: Sanden; Number of Ribs: 8	8FK 351 135-641 Compressor, air conditioning BEHR HELLA SERVICE Version ALTERNATIVE	403							
					8FT 351 197-481 Dryer, air conditioning	408							
				Depth [mm]: 65; L 307 mm; with expansion valve; Vers. produced by BEHR; W 200 mm	8FV 351 336-111 Evaporator, air conditioning	409							
				Diameter 1 [mm]: 18; Diameter 2 [mm]: 18; Diameter 3 [mm]: 10; Diameter 4 [mm]: 12; + OE 81.61967.0020; R 134a	8UW 351 336-161 Expansion Valve, air conditioning	410							
32.410 FFDLC, FFDLC, FFDRC, FFDLRC	301 kW		01/02→	Depth [mm]: 16; L 750 mm; without dehumidifier; Vers. produced by BEHR; W 351 mm	8FC 351 300-121 Condenser, air conditioning	405							
				Compressor ID: SD7H15; Manufacturer Restriction: Sanden; New Part: 1; Number of Ribs: 8	8FK 351 135-141 Compressor, air conditioning	402							
				Compressor ID: SD7H15; Manufacturer Restriction: Sanden; Number of Ribs: 8	8FK 351 135-641 Compressor, air conditioning BEHR HELLA SERVICE Version ALTERNATIVE	403							
					8FT 351 197-481 Dryer, air conditioning	408							
				Depth [mm]: 67; L 385 mm; with expansion valve; Vers. produced by BEHR; W 203 mm	8FV 351 330-111 Evaporator, air conditioning	409							
				Depth [mm]: 65; L 307 mm; with expansion valve; Vers. produced by BEHR; W 200 mm	8FV 351 336-111 Evaporator, air conditioning	409							
				-03/04; Diameter 1 [mm]: 18; Diameter 2 [mm]: 15; Diameter 3 [mm]: 10; Diameter 4 [mm]: 12; R 134a	8UW 351 239-381 Expansion Valve, air conditioning	410							
				Diameter 1 [mm]: 18; Diameter 2 [mm]: 18; Diameter 3 [mm]: 10; Diameter 4 [mm]: 12; + OE 81.61967.0020; R 134a	8UW 351 336-161 Expansion Valve, air conditioning	410							
MAN - TGL						04/05→							
10.180 FC, FRC, FLC, FLRC 10.180 FK, FRK 10.210 FC, FRC, FLC, FLRC 10.210 FK, FRK 10.220 FC, FLC, FRC, FLRC 10.220 FK, FRK 10.240 FC, FRC, FLC, FLRC 10.240 FK, FRK 10.250 FC, FLC, FRC, FLRC 10.250 FK, FRK	132 kW 132 kW 151 kW 151 kW 162 kW 162 kW 176 kW 176 kW 184 kW 184 kW		04/05→ 04/05→ 04/05→ 04/05→ 04/05→ 04/05→ 04/05→ 04/05→ 04/05→ 04/05→	Depth [mm]: 16; L 590 mm; with dryer; Vers. produced by BEHR; W 479 mm	8FC 351 029-371 Condenser, air conditioning	404							
				Depth [mm]: 16; L 750 mm; without dehumidifier; Vers. produced by BEHR; W 351 mm	8FC 351 300-121 Condenser, air conditioning	405							
				Compressor ID: SD7H15; Manufacturer Restriction: Sanden; New Part: 1; Number of Ribs: 8	8FK 351 135-231 Compressor, air conditioning	402							
					8FT 351 197-481 Dryer, air conditioning	408							
				Depth [mm]: 65; L 307 mm; with expansion valve; Vers. produced by BEHR; W 200 mm	8FV 351 336-111 Evaporator, air conditioning	409							
				12.180 FC, FRC, FLC, FLRC 12.180 FK, FRK 12.210 FC, FRC, FLC, FLRC 12.210 FK, FRK 12.240 FC, FRC, FLC, FLRC 12.240 FK, FRK	132 kW 132 kW 151 kW 151 kW 176 kW 176 kW		04/05→ 04/05→ 04/05→ 04/05→ 04/05→ 04/05→	Depth [mm]: 16; L 590 mm; with dryer; Vers. produced by BEHR; W 479 mm	8FC 351 029-371 Condenser, air conditioning	404			
								Depth [mm]: 16; L 750 mm; without dehumidifier; Vers. produced by BEHR; W 351 mm	8FC 351 300-121 Condenser, air conditioning	405			

Manufacturer - Model	Power	Displ.	Year of Constr.	Remark	Part Number	Page	
MAN - TGL						04/05→	
12.180 FC, FRC, FLC, FLRC	132 kW		04/05→	Compressor ID: SD7H15; Manufacturer Restriction: Sanden; New Part: 1; Number of Ribs: 8	8FK 351 135-231	402	
12.180 FK, FRK	132 kW		04/05→		Compressor, air conditioning		
12.210 FC, FRC, FLC, FLRC	151 kW		04/05→		8FT 351 197-481 Dryer, 408	air conditioning	
12.210 FK, FRK	151 kW		04/05→			air conditioning	
12.240 FC, FRC, FLC, FLRC	176 kW		04/05→		Depth [mm]: 67; L 385 mm; with expansion valve; Vers. produced by BEHR; W 203 mm	8FV 351 330-111	409
12.240 FK, FRK	176 kW		04/05→		Depth [mm]: 65; L 307 mm; with expansion valve; Vers. produced by BEHR; W 200 mm	8FV 351 336-111	409
					Diameter 1 [mm]: 18; Diameter 2 [mm]: 15; Diameter 3 [mm]: 10; Diameter 4 [mm]: 12; R 134a	8UW 351 239-381	410
				Diameter 1 [mm]: 18; Diameter 2 [mm]: 18; Diameter 3 [mm]: 10; Diameter 4 [mm]: 12; + OE 81.61967.0020; R 134a	8UW 351 336-161	410	
12.220 FC, FRC, FLC, FLRC	162 kW		04/05→	Depth [mm]: 16; L 590 mm; with dryer; Vers. produced by BEHR; W 479 mm	8FC 351 029-371	404	
12.220 FK, FRK	162 kW		04/05→		Condenser, air conditioning		
12.250 FC, FLC, FRC, FLRC	184 kW		04/05→	Depth [mm]: 16; L 750 mm; without dehumidifier; Vers. produced by BEHR; W 351 mm	8FC 351 300-121	405	
12.250 FK, FRK	184 kW		04/05→		Condenser, air conditioning		
8.180 FC, FRC, FLC, FLRC	132 kW		04/05→	Compressor ID: SD7H15; Manufacturer Restriction: Sanden; New Part: 1; Number of Ribs: 8	8FK 351 135-231	402	
8.180 FK, FK-L, FRK, FRK-L	132 kW		04/05→		Compressor, air conditioning		
8.210 FC, FRC, FLC, FLRC	151 kW		04/05→		8FT 351 197-481 Dryer, 408	air conditioning	
8.210 FK, FK-L, FRK, FRK-L	151 kW		04/05→		air conditioning		
8.220 FC, FLC, FRC, FLRC	162 kW		04/05→	Filter Insert	8FT 351 198-481 Dryer, 408	air conditioning	
8.220 FK, FRK, FK-L, FRK-L	162 kW		04/05→		air conditioning		
8.240 FC, FRC, FLC, FLRC	176 kW		04/05→	Depth [mm]: 67; L 385 mm; with expansion valve; Vers. produced by BEHR; W 203 mm	8FV 351 330-111	409	
8.240 FK, FK-L, FRK, FRK-L	176 kW		04/05→		Evaporator, air conditioning		
8.250 FC, FLC, FLRC, FRC	184 kW		04/05→	Depth [mm]: 65; L 307 mm; with expansion valve; Vers. produced by BEHR; W 200 mm	8FV 351 336-111	409	
8.250 FK, FK-L, FRK, FRK-L	184 kW		04/05→		Evaporator, air conditioning		
				Diameter 1 [mm]: 18; Diameter 2 [mm]: 15; Diameter 3 [mm]: 10; Diameter 4 [mm]: 12; R 134a	8UW 351 239-381	410	
				Diameter 1 [mm]: 18; Diameter 2 [mm]: 18; Diameter 3 [mm]: 10; Diameter 4 [mm]: 12; + OE 81.61967.0020; R 134a	8UW 351 336-161	410	
7.150, 8.150 FC, FRC, FLC, FLRC	110 kW		04/05→	Depth [mm]: 16; L 590 mm; with dryer; Vers. produced by BEHR; W 479 mm	8FC 351 029-371	404	
7.180 FC, FLC, FRC, FLRC	132 kW		04/05→		Condenser, air conditioning		
7.220 FC, FLC, FRC, FLRC	162 kW		04/05→	Depth [mm]: 16; L 750 mm; without dehumidifier; Vers. produced by BEHR; W 351 mm	8FC 351 300-121	405	
7.250 FC, FLC, FRC, FLRC	184 kW		04/05→		Condenser, air conditioning		
				Compressor ID: SD7H15; Manufacturer Restriction: Sanden; New Part: 1; Number of Ribs: 8	8FK 351 135-231	402	
					Compressor, air conditioning		
					8FT 351 197-481 Dryer, 408	air conditioning	
				Filter Insert	8FT 351 198-481 Dryer, 408	air conditioning	
				Depth [mm]: 65; L 307 mm; with expansion valve; Vers. produced by BEHR; W 200 mm	8FV 351 336-111	409	
					Evaporator, air conditioning		
				Diameter 1 [mm]: 18; Diameter 2 [mm]: 18; Diameter 3 [mm]: 10; Diameter 4 [mm]: 12; + OE 81.61967.0020; R 134a	8UW 351 336-161	410	
					Expansion Valve, air conditioning		

Manufacturer - Model	Power	Displ.	Year of Constr.	Remark	Part Number	Page
MAN - TGL						04/05→
8.150 FK, FRK, FK-L, FRK-L	110 kW		10/06→	Depth [mm]: 16; L 590 mm; with dryer; Vers. produced by BEHR; W 479 mm	8FC 351 029-371 Condenser, air conditioning	404
				Depth [mm]: 16; L 750 mm; without dehumidifier; Vers. produced by BEHR; W 351 mm	8FC 351 300-121 Condenser, air conditioning	405
					8FT 351 197-481 Dryer, air conditioning	408
				Filter Insert	8FT 351 198-481 Dryer, air conditioning	408
				Depth [mm]: 65; L 307 mm; with expansion valve; Vers. produced by BEHR; W 200 mm	8FV 351 336-111 Evaporator, air conditioning	409
				Diameter 1 [mm]: 18; Diameter 2 [mm]: 18; Diameter 3 [mm]: 10; Diameter 4 [mm]: 12; + OE 81.61967.0020; R 134a	8UW 351 336-161 Expansion Valve, air conditioning	410
MAN - TGM						10/05→
12.240 FLC, FLLC 12.280 FC, FLC, FLLC	176 kW 206 kW		10/05→ 10/05→		8FT 351 197-481 Dryer, air conditioning	408
				Depth [mm]: 65; L 307 mm; with expansion valve; Vers. produced by BEHR; W 200 mm	8FV 351 336-111 Evaporator, air conditioning	409
				Diameter 1 [mm]: 18; Diameter 2 [mm]: 18; Diameter 3 [mm]: 10; Diameter 4 [mm]: 12; + OE 81.61967.0020; R 134a	8UW 351 336-161 Expansion Valve, air conditioning	410
12.250 FLC, FLLC 12.290 FLC, FLLC 22.240 FNLLC 22.250 FNLLC 22.280 FNL, 22.280 FNLLC 22.290 FNL, 22.290 FNLLC	184 kW 213 kW 176 kW 184 kW 206 kW 213 kW		10/05→ 10/05→ 10/05→ 10/05→ 10/05→ 10/05→	Depth [mm]: 16; L 590 mm; with dryer; Vers. produced by BEHR; W 479 mm	8FC 351 029-371 Condenser, air conditioning	404
				Compressor ID: SD7H15; Manufacturer Restriction: Sanden; New Part: 1; Number of Ribs: 8	8FK 351 135-231 Compressor, air conditioning	402
					8FT 351 197-481 Dryer, air conditioning	408
				Depth [mm]: 65; L 307 mm; with expansion valve; Vers. produced by BEHR; W 200 mm	8FV 351 336-111 Evaporator, air conditioning	409
				Diameter 1 [mm]: 18; Diameter 2 [mm]: 18; Diameter 3 [mm]: 10; Diameter 4 [mm]: 12; + OE 81.61967.0020; R 134a	8UW 351 336-161 Expansion Valve, air conditioning	410
13.240 FAL, FALC, FALRC, FAEC, FAERC, FALR 13.240 FALK, FALRK, FALK-L, FALRK-L 13.280 FAEC, FAERC, FAL, FALC, FALRC 13.280 FALK, FALRK, FALK-L, FALRK-L 18.240 FAC, FARC 18.280 FAC, FARC 18.330 FAC, FARC	176 kW 176 kW 206 kW 206 kW 176 kW 206 kW 240 kW		04/06→ 04/06→ 04/06→ 04/06→ 10/05→ 10/05→ 10/05→	Depth [mm]: 16; L 590 mm; with dryer; Vers. produced by BEHR; W 479 mm	8FC 351 029-371 Condenser, air conditioning	404
				Filter Insert	8FT 351 198-481 Dryer, air conditioning	408
				Depth [mm]: 65; L 307 mm; with expansion valve; Vers. produced by BEHR; W 200 mm	8FV 351 336-111 Evaporator, air conditioning	409
				Diameter 1 [mm]: 18; Diameter 2 [mm]: 18; Diameter 3 [mm]: 10; Diameter 4 [mm]: 12; + OE 81.61967.0020; R 134a	8UW 351 336-161 Expansion Valve, air conditioning	410
13.250 FAEC, FAERC, FALC, FAL, FALRC, FALR 13.250 FALK, FALRK, FALK-L, FALRK-L 13.290 FAEC, FAERC, FAL, FALR, FALC, FALRC 13.290 FALK, FALRK, FALK-L, FALRK-L 15.240 FLK, FLRK 15.250 FC, FLC, FLRC, FLLC, FLLRC 15.250 FLK, FLRK 15.280 FLK, FLRK 15.290 FC, FLC, FLRC, FLLC, FLLRC 15.290 FLK, FLRK 15.330 FC, FLC, FRC, FLRC 15.330 FLK, FLRK 15.340 FC, FLC, FLRC 15.340 FLK, FLRK 18.240 FAK, FARK, FAK-L, FARK-L 18.250 FAC, FARC 18.250 FAK, FARK, FAK-L, FARK-L	184 kW 184 kW 213 kW 213 kW 176 kW 184 kW 184 kW 206 kW 213 kW 213 kW 240 kW 240 kW 250 kW 250 kW 176 kW 184 kW 184 kW		10/05→ 10/05→ 10/05→ 10/05→ 10/05→ 10/05→ 10/05→ 10/05→ 10/05→ 10/05→ 10/05→ 10/05→ 10/05→ 10/05→ 10/05→ 10/05→ 10/05→ 10/05→ 10/05→	Depth [mm]: 16; L 590 mm; with dryer; Vers. produced by BEHR; W 479 mm	8FC 351 029-371 Condenser, air conditioning	404
				Compressor ID: SD7H15; Manufacturer Restriction: Sanden; New Part: 1; Number of Ribs: 8	8FK 351 135-231 Compressor, air conditioning	402
					8FT 351 197-481 Dryer, air conditioning	408
				Filter Insert	8FT 351 198-481 Dryer, air conditioning	408
				Depth [mm]: 65; L 307 mm; with expansion valve; Vers. produced by BEHR; W 200 mm	8FV 351 336-111 Evaporator, air conditioning	409
				Diameter 1 [mm]: 18; Diameter 2 [mm]: 18; Diameter 3 [mm]: 10; Diameter 4 [mm]: 12; + OE 81.61967.0020; R 134a	8UW 351 336-161 Expansion Valve, air conditioning	410

Manufacturer - Model	Power	Displ.	Year of Constr.	Remark	Part Number	Page
MAN - TGM						10/05→
18.280 FAK, FARK, FAK-L, FARK-L	206 kW		10/05→	Depth [mm]: 16; L 590 mm; with dryer; Vers. produced by BEHR; W 479 mm	8FC 351 029-371 Condenser, air conditioning	404
18.290 FAC, FARC	213 kW		10/05→			
18.290 FAK, FARK, FAK-L, FARK-L	213 kW		10/05→	Compressor ID: SD7H15; Manufacturer Restriction: Sanden; New Part: 1; Number of Ribs: 8	8FK 351 135-231 Compressor, air conditioning	402
18.330 FAK, FARK, FAK-L, FARK, L	240 kW		10/05→			
18.340 FAC, FARC	250 kW		10/05→		8FT 351 197-481 Dryer, air conditioning	408
18.340 FAK, FARK, FAK-L, FARK-L	250 kW		10/05→			
26.280 FD	206 kW		10/05→			
26.280 FNLC, FNLLC, FNLC, FNLLRC	206 kW		10/05→	Depth [mm]: 65; L 307 mm; with expansion valve; Vers. produced by BEHR; W 200 mm	8FV 351 336-111 Evaporator, air conditioning	409
26.290 FD, FDR	213 kW		10/05→			
26.290 FDK-HK, FDRK-HK	213 kW		10/05→			
26.290 FD-TM, FDR-TM	213 kW		07/08→			
26.290 FNLC, FNLLC, FNLC, FNLLRC, FVL	213 kW		10/05→	Diameter 1 [mm]: 18; Diameter 2 [mm]: 18; Diameter 3 [mm]: 10; Diameter 4 [mm]: 12; + OE 81.61967.0020; R 134a	8UW 351 336-161 Expansion Valve, air conditioning	410
26.330 FD, FDR	240 kW		10/05→			
26.330 FNLC, FNLLC, FNLC, FNLLRC, FVL	240 kW		10/05→			
26.340 FD, FDR	250 kW		10/05→			
26.340 FDK-HK, FDRK-HK	250 kW		10/05→			
26.340 FD-TM, FDR-TM	250 kW		07/08→			
26.340 FNLC, FNLLC, FNLC, FNLLRC	250 kW		10/05→			
15.240 FC, FLC, FLLC, FLRC, FLLRC	176 kW		10/05→	Depth [mm]: 16; L 590 mm; with dryer; Vers. produced by BEHR; W 479 mm	8FC 351 029-371 Condenser, air conditioning	404
					8FT 351 197-481 Dryer, air conditioning	408
					8FT 351 198-481 Dryer, air conditioning	408
				Depth [mm]: 65; L 307 mm; with expansion valve; Vers. produced by BEHR; W 200 mm	8FV 351 336-111 Evaporator, air conditioning	409
				Diameter 1 [mm]: 18; Diameter 2 [mm]: 18; Diameter 3 [mm]: 10; Diameter 4 [mm]: 12; + OE 81.61967.0020; R 134a	8UW 351 336-161 Expansion Valve, air conditioning	410
15.280 FC, FRC, FLC, FLRC, FLLRC	206 kW		10/05→		8FT 351 197-481 Dryer, air conditioning	408
					8FT 351 198-481 Dryer, air conditioning	408
				Depth [mm]: 65; L 307 mm; with expansion valve; Vers. produced by BEHR; W 200 mm	8FV 351 336-111 Evaporator, air conditioning	409
				Diameter 1 [mm]: 18; Diameter 2 [mm]: 18; Diameter 3 [mm]: 10; Diameter 4 [mm]: 12; + OE 81.61967.0020; R 134a	8UW 351 336-161 Expansion Valve, air conditioning	410
18.240 FC, FRC, FLC, FLRC, FLLC, FLLRC	176 kW		10/05→	Depth [mm]: 16; L 590 mm; with dryer; Vers. produced by BEHR; W 479 mm	8FC 351 029-371 Condenser, air conditioning	404
18.240 FK, FRK, FLK, FK-L, FLRK	176 kW		10/05→			
18.250 FC, FRC, FLLC, FRC, FLRC, FLLRC	184 kW		10/05→	Compressor ID: SD7H15; Manufacturer Restriction: Sanden; New Part: 1; Number of Ribs: 8	8FK 351 135-231 Compressor, air conditioning	402
18.250 FK, FLK, FRK, FLRK	184 kW		10/05→			
18.280 FC, FRC, FLC, FLRC, FLLC, FLLRC	206 kW		10/05→		8FT 351 197-481 Dryer, air conditioning	408
18.280 FK, FLK, FRK, FLRK, FK-L	206 kW		10/05→			
18.290 FC, FLC, FRC, FLRC, FLLC, FLLRC	213 kW		10/05→	Depth [mm]: 67; L 385 mm; with expansion valve; Vers. produced by BEHR; W 203 mm	8FV 351 330-111 Evaporator, air conditioning	409
18.290 FK, FLK, FRK, FLRK	213 kW		10/05→			
18.330 FC, FRC, FLC, FLRC, FLLC, FLLRC	240 kW		10/05→	Depth [mm]: 65; L 307 mm; with expansion valve; Vers. produced by BEHR; W 200 mm	8FV 351 336-111 Evaporator, air conditioning	409
18.330 FK, FLK, FRK, FLRK, FK-L	240 kW		10/05→			
18.340 FC, FLC, FLRC, FLLC, FLLRC, FRC	250 kW		10/05→	Diameter 1 [mm]: 18; Diameter 2 [mm]: 15; Diameter 3 [mm]: 10; Diameter 4 [mm]: 12; R 134a	8UW 351 239-381 Expansion Valve, air conditioning	410
18.340 FK, FRK, FLK, FLRK	250 kW		10/05→	Diameter 1 [mm]: 18; Diameter 2 [mm]: 18; Diameter 3 [mm]: 10; Diameter 4 [mm]: 12; + OE 81.61967.0020; R 134a	8UW 351 336-161 Expansion Valve, air conditioning	410

Manufacturer - Model	Power	Displ.	Year of Constr.	Remark	Part Number	Page
MAN - TGM						10/05→
26.280 FDK-HK, FDRK-HK	206 kW		04/06→	Filter Insert	8FT 351 198-481	Dryer, 408 air conditioning
26.280 FD-TM, FDR-TM	206 kW		04/06→			
26.330 FDK-HK, FDRK-HK	240 kW		04/06→	Depth [mm]: 65; L 307 mm; with expansion valve; Vers. produced by BEHR; W 200 mm	8FV 351 336-111	409 Evaporator, air conditioning
26.330 FD-TM, FDR-TM	240 kW		04/06→	Diameter 1 [mm]: 18; Diameter 2 [mm]: 18; Diameter 3 [mm]: 10; Diameter 4 [mm]: 12; + OE 81.61967.0020; R 134a	8UW 351 336-161	410 Expansion Valve, air conditioning
MAN - TGS						09/07→
18.320 FAC, FHLC	235 kW		10/07→	Depth [mm]: 16; L 750 mm; without dehumidifier; Vers. produced by BEHR; W 351 mm	8FC 351 300-121	405 Condenser, air conditioning
18.320 FAK, FAK-L, FALK, FALK-L, FHLK, FHLK/M	235 kW		10/07→			
18.320 FAS, FHLS, FHLS/M	235 kW		10/07→	Depth [mm]: 16; Inner Diameter 1 [mm]: 14.35; Inner Diameter 2 [mm]: 11.05; L 765 mm; with dryer; Vers. produced by BEHR; W 351 mm	8FC 351 319-471	407 Condenser, air conditioning
18.320 FC, FLC, FLRC, FLLC, FLLRC, FLLW, FLLW/N	235 kW		10/07→			
18.320 FK, FK-L, FLK, FLK/M	235 kW		10/07→	Compressor ID: SD7H15; Manufacturer Restriction: Sanden; New Part: 1; Number of Ribs: 8	8FK 351 135-141	402 Compressor, air conditioning
18.320 FLS, FLS/M, FLS-TS, FLRS, FLRS/M, FLLS, FLLS/N, FLLRS	235 kW		10/07→			
18.360 FAC, FHLC	265 kW		10/07→	Compressor ID: SD7H15; Manufacturer Restriction: Sanden; Number of Ribs: 8	8FK 351 135-641	403 Compressor, air conditioning BEHR HELLA SERVICE Version ALTERNATIVE
18.360 FAK, FAK-L, FALK, FALK-L, FHLK, FHLK/M	265 kW		10/07→			
18.360 FAS, FALS, FHLS, FHLS/M	265 kW		10/07→			
18.360 FC, FLC, FLRC, FLLC, FLLRC, FLLW, FLLW/N	265 kW		10/07→	Ø 37.1 mm; L 400 mm	8FT 351 193-201	408 Dryer, air conditioning
18.360 FK, FK-L, FLK, FLK/M	265 kW		10/07→			
18.360 FLS, FLS/M, FLS-TS, FLRS, FLRS/M, FLLS, FLLS/N, FLLRS	265 kW		10/07→	Depth [mm]: 65; L 307 mm; with expansion valve; Vers. produced by BEHR; W 200 mm	8FV 351 336-111	409 Evaporator, air conditioning
18.400 FAC, FHLC	294 kW		10/07→	Diameter 1 [mm]: 18; Diameter 2 [mm]: 18; Diameter 3 [mm]: 10; Diameter 4 [mm]: 12; + OE 81.61967.0020; R 134a	8UW 351 336-161	410 Expansion Valve, air conditioning
18.400 FAK, FAK-L, FALK, FALK-L, FHLK, FHLK/M	294 kW		10/07→			
18.400 FAS, FALS, FHLS, FHLS/M	294 kW		10/07→			
18.400 FC, FLC, FLRC, FLLC, FLLRC, FLLW, FLLW/N	294 kW		10/07→			
18.400 FK, FK-L, FLK, FLK/M	294 kW		10/07→			
18.400 FLS, FLS/M, FLS-TS, FLRS, FLRS/M, FLLS, FLLS/N, FLLRS	294 kW		10/07→			
18.440 FAC, FHLC	324 kW		10/07→			
18.440 FAK, FAK-L, FALK, FALK-L, FHLK, FHLK/M	324 kW		10/07→			
18.440 FAS, FALS, FHLS, FHLS/M	324 kW		10/07→			
18.440 FC, FLC, FLRC, FLLC, FLLRC, FLLW, FLLW/N	324 kW		10/07→			
18.440 FK, FK-L, FLK, FLK/M	324 kW		10/07→			
18.440 FLS, FLS/M, FLS-TS, FLRS, FLRS/M, FLLS, FLLS/N, FLLRS	324 kW		10/07→			
18.480 FAC, FHLC	353 kW		10/07→			
18.480 FAK, FAK-L, FALK, FALK-L, FHLK, FHLK/M	353 kW		10/07→			
18.480 FAS, FALS, FHLS, FHLS/M	353 kW		10/07→			
18.480 FC, FLC, FLRC, FLLC, FLLRC, FLLW, FLLW/N	353 kW		10/07→			
18.480 FK, FK-L, FLK, FLK/M	353 kW		10/07→			
18.480 FLS, FLS/M, FLS-TS, FLRS, FLRS/M, FLLS, FLLS/N, FLLRS	353 kW		10/07→			
18.540 FAC, FHLC	397 kW		10/07→			
18.540 FAK, FAK-L, FALK, FALK-L, FHLK, FHLK/M	397 kW		10/07→			
18.540 FAS, FALS, FHLS, FHLS/M	397 kW		10/07→			
18.540 FC, FLC, FLRC, FLLC, FLLRC, FLLW, FLLW/N	397 kW		10/07→			
18.540 FK, FK-L, FLK, FLK/M	397 kW		10/07→			
18.540 FLS, FLS/M, FLRS, FLRS/M, FLLS, FLLS/N, FLLRS	397 kW		10/07→			
26.320 FDAC, FDALC, FDHLC, FDHLC/M	235 kW		07/08→			
26.320 FDAK, FDALK, FDHK, FDHLK	235 kW		07/08→			
26.320 FDAS, FDALS, FDHS, FDHLS, FDHLS/M	235 kW		07/08→			

Manufacturer - Model	Power	Displ.	Year of Constr.	Remark	Part Number	Page
MAN - TGS						09/07→
26.320 FDC, FDRC, FDLC, FDLC/M, FDLRC, FDLRC/M, FNHLC	235 kW		07/08→	Depth [mm]: 16; L 750 mm; without dehumidifier; Vers. produced by BEHR; W 351 mm	8FC 351 300-121 Condenser, air conditioning	405
26.320 FDK, FDLK	235 kW		07/08→	Depth [mm]: 16; Inner Diameter 1 [mm]: 14.35; Inner Diameter 2 [mm]: 11.05; L 765 mm; with dryer; Vers. produced by BEHR; W 351 mm	8FC 351 319-471 Condenser, air conditioning	407
26.320 FDS, FDLS, FDLS/M, FDRS, FDLRS, FDLRS/M, FNHLS	235 kW		07/08→			
26.320 FD-TM	235 kW		07/08→	Compressor ID: SD7H15; Manufacturer Restriction: Sanden; New Part: 1; Number of Ribs: 8	8FK 351 135-141 Compressor, air conditioning	402
26.320 FNLC, FNLRC, FNLLC, FNLLRC, FNLLW, FVLC, FVL-KO	235 kW		10/07→			
26.320 FNLS, FNLRS, FNLLS, FPLS, FVLS	235 kW		07/08→	Compressor ID: SD7H15; Manufacturer Restriction: Sanden; Number of Ribs: 8	8FK 351 135-641 Compressor, air conditioning BEHR HELLA SERVICE Version ALTERNATIVE	403
26.320 FVHLC	235 kW		10/07→			
26.360 FDAC, FDALC, FDHLC, FDHLC/M	265 kW		08/08→	Ø 37.1 mm; L 400 mm	8FT 351 193-201 Dryer, air conditioning	408
26.360 FDAK, FDALK, FDHK, FDHLK	265 kW		08/08→		8FT 351 197-481 Dryer, air conditioning	408
26.360 FDAS, FDALS, FDHS, FDHLS, FDHLS/M	265 kW		08/08→	Depth [mm]: 65; L 307 mm; with expansion valve; Vers. produced by BEHR; W 200 mm	8FV 351 336-111 Evaporator, air conditioning	409
26.360 FDC, FDRC, FDRC/M, FDLC, FDLRC, FNHLC	265 kW		08/08→	Diameter 1 [mm]: 18; Diameter 2 [mm]: 18; Diameter 3 [mm]: 10; Diameter 4 [mm]: 12; + OE 81.61967.0020; R 134a	8UW 351 336-161 Expansion Valve, air conditioning	410
26.360 FDK, FDLK, FDRK	265 kW		08/08→			
26.360 FDS, FDRS, FDRS/M, FDLS, FDLRS, FNHLS	265 kW		08/08→			
26.360 FD-TM	265 kW		07/08→			
26.360 FNLC, FNLRC, FNLLC, FNLLRC, FVLC, FVL-KO	265 kW		10/07→			
26.360 FNLLW	265 kW		04/08→			
26.360 FNLS, FNLLS, FNLRS, FPLS, FPLRS, FVLS	265 kW		08/08→			
26.360 FPHLS	265 kW		05/08→			
26.360 FVHLC	265 kW		10/07→			
26.360 FVHLS	265 kW		05/08→			
26.400 FDAC, FDALC, FDHLC, FDHLC/M	294 kW		02/09→			
26.400 FDAK, FDALK, FDHK, FDHLK	294 kW		11/07→			
26.400 FDAS, FDALS, FDHS, FDHLS, FDHLS/M	294 kW		09/07→			
26.400 FDC, FDRC, FDC/M, FDLC, FDLC/M, FDLRC, FDLRC/M, FNHLC	294 kW		08/08→			
26.400 FDK, FDLK	294 kW		02/09→			
26.400 FDS, FDS/M, FDLS, FDLS/M, FDRS, FDLRS, FNHLS	294 kW		02/09→			
26.400 FD-TM	294 kW		07/08→			
26.400 FNLC, FNLRC, FNLLC, FNLLRC, FVLC, FVL-KO, FNLLW	294 kW		10/07→			
26.400 FNLS, FNLRS, FNLLS, FNLLRS, FPLS, FPLRS, FVLS	294 kW		02/09→			
26.400 FPHLS	294 kW		05/08→			
26.400 FVHLC	294 kW		10/07→			
26.400 FVHLS	294 kW		05/08→			
26.440 FDAC, FDALC, FDHLC, FDHLC/M	324 kW		02/09→			
26.440 FDAK, FDALK, FDHK, FDHLK	324 kW		11/07→			
26.440 FDAS, FDALS, FDHLS, FDHLS/M	324 kW		02/09→			
26.440 FDC, FDRC, FDC/M, FDLC, FDLC/M, FDLRC, FNHLC	324 kW		02/09→			
26.440 FDK, FDLK	324 kW		07/08→			
26.440 FDS, FDRS, FDS/M, FDLS, FDLRS, FNHLS	324 kW		02/09→			
26.440 FD-TM	324 kW		07/08→			
26.440 FNLC, FNLLC, FNLLW, FNLRC, FNLLRC, FVLC, FVL-KO	324 kW		10/07→			
26.440 FNLS, FNLLS, FNLRS, FPLS, FPLRS, FVLS	324 kW		02/09→			
26.440 FPHLS	324 kW		05/08→			
26.440 FVHLC	324 kW		10/07→			
26.440 FVHLS	324 kW		05/08→			
26.480 FDAC, FDALC, FDHLC, FDHLC/M	353 kW		02/09→			
26.480 FDAK, FDALK, FDHK, FDHLK	353 kW		02/09→			
26.480 FDAS, FDALS, FDHS, FDHLS	353 kW		02/09→			

Manufacturer - Model	Power	Displ.	Year of Constr.	Remark	Part Number	Page
MAN - TGS						09/07→
26.480 FDC, FDC/M, FDLC, FDLC/M, FDRC, FDRC/M, FDLRC, FNLHC	353 kW		02/09→	Depth [mm]: 16; L 750 mm; without dehumidifier; Vers. produced by BEHR; W 351 mm	8FC 351 300-121 Condenser, air conditioning	405
26.480 FDK, FDLK	353 kW		07/08→	Depth [mm]: 16; Inner Diameter 1 [mm]: 14.35; Inner Diameter 2 [mm]: 11.05; L 765 mm; with dryer; Vers. produced by BEHR; W 351 mm	8FC 351 319-471 Condenser, air conditioning	407
26.480 FDS, FDS/M, FDLS, FDLS/M, FDRS, FDLRS, FDRS/M, FNHLS	353 kW		02/09→			
26.480 FNLC, FNLRC, FNLLC, FNLLRC, FNLLW, FVLC, FVL-KO	353 kW		10/07→	Compressor ID: SD7H15; Manufacturer Restriction: Sanden; New Part: 1; Number of Ribs: 8	8FK 351 135-141 Compressor, air conditioning	402
26.480 FNLS, FNLLS, FNLRS, FPLS, FPLRS, FVLS	353 kW		02/09→	Compressor ID: SD7H15; Manufacturer Restriction: Sanden; Number of Ribs: 8	8FK 351 135-641 Compressor, air conditioning BEHR HELLA SERVICE Version ALTERNATIVE	403
26.480 FPHLS	353 kW		05/08→			
26.480 FVHLC	353 kW		10/07→			
26.480 FVHLS	353 kW		05/08→			
26.540 FDAC, FDALC, FDHLC, FDHLC/M	397 kW		02/09→			
26.540 FDAK, FDALK, FDHLK	397 kW		11/07→	Ø 37.1 mm; L 400 mm	8FT 351 193-201 Dryer, 408 air conditioning	
26.540 FDAS, FDALS, FDHLS	397 kW		02/09→			
26.540 FDC, FDC/M, FDLC, FDLC/M, FDLRC, FDLRC/M, FNHLC	397 kW		02/09→	Depth [mm]: 65; L 307 mm; with expansion valve; Vers. produced by BEHR; W 200 mm	8FV 351 336-111 Evaporator, air conditioning	409
26.540 FDK, FDLK	397 kW		02/09→	Diameter 1 [mm]: 18; Diameter 2 [mm]: 18; Diameter 3 [mm]: 10; Diameter 4 [mm]: 12; + OE 81.61967.0020; R 134a	8UW 351 336-161 Expansion Valve, air conditioning	410
26.540 FDS, FDS/M, FDLS, FDRS, FDLRS, FDLS/M, FNHLS	397 kW		02/09→			
26.540 FNLC, FNLRC, FNLLC, FNLLRC, FNLLW, FVLC, FVL-KO	397 kW		10/07→			
26.540 FNLS, FNLLS, FPLS, FPLRS, FVLS	397 kW		02/09→			
32.320 FFD-TM	235 kW		02/09→			
32.360 FFDRC	265 kW		08/08→			
32.360 FFD-TM, FFDRC-TM	265 kW		10/07→			
32.400 FFDRC	294 kW		08/08→			
32.400 FFD-TM, FFDRC-TM	294 kW		10/07→			
32.440 FFDRC	324 kW		08/08→			
32.440 FFD-TM, FFDRC-TM	324 kW		10/07→			
32.480 FFD-TM	353 kW		08/08→			
35.320 FFDAK	235 kW		06/08→			
35.320 FFDAK, FFDHLK	235 kW		06/08→			
35.320 FFDC, FFDLC, FDNLC	235 kW		06/08→			
35.320 FFDK, FFDLK	235 kW		08/08→			
35.320 FFD-TM	235 kW		10/07→			
35.320 FFNLC	235 kW		01/09→			
35.360 FFDAK	265 kW		06/08→			
35.360 FFDAK, FFHDLK	265 kW		06/08→			
35.360 FFDC, FFDLC, FDNLC	265 kW		06/08→			
35.360 FFDK, FFDLK, FFDRC	265 kW		08/08→			
35.360 FFD-TM	265 kW		10/07→			
35.360 FFNLC	265 kW		06/08→			
35.400 FFDAK	294 kW		06/08→			
35.400 FFDAK, FFDHLK	294 kW		06/08→			
35.400 FFDC, FFDLC, FDNLC	294 kW		06/08→			
35.400 FFDK, FFDLK, FFDRC	294 kW		08/08→			
35.400 FFD-TM	294 kW		10/07→			
35.400 FFNHLC	294 kW		10/07→			
35.400 FFNLC	294 kW		06/08→			
35.440 FDNLC, FFDC, FFDLC, FFNLC	324 kW		06/08→			
35.440 FFDAK	324 kW		06/08→			
35.440 FFDAK, FFDHLK	324 kW		06/08→			
35.440 FFDK, FFDLK, FFDRC	324 kW		08/08→			
35.440 FFD-TM	324 kW		10/07→			
35.440 FFNHLC	324 kW		10/07→			
35.440 FFNLC	324 kW		06/08→			
35.480 FDNLC, FFDC, FFDLC	353 kW		06/08→			
35.480 FFDAK	353 kW		06/08→			
35.480 FFDAK, FFDHLK	353 kW		06/08→			
35.480 FFDK, FFDLK, FFDRC	353 kW		08/08→			
35.480 FFD-TM	353 kW		10/07→			
35.480 FFNHLC	353 kW		10/07→			
35.480 FFNLC	353 kW		06/08→			
35.540 FDNLC, FFDC, FFDLC	397 kW		06/08→			
35.540 FFDAK	397 kW		02/09→			
35.540 FFDAK, FFDHLK	397 kW		02/09→			
35.540 FFDK, FFDLK, FFDRC	397 kW		02/09→			
35.540 FFD-TM	397 kW		10/07→			
35.540 FFNLC	397 kW		02/09→			

Manufacturer - Model	Power	Displ.	Year of Constr.	Remark	Part Number	Page
MAN - TGS						09/07→
19.360 FS/M-WW, FLS/M-WW, FRS/M-WW, FLRS/M-WW	265 kW		02/11→	Depth [mm]: 65; L 307 mm; with expansion valve; Vers. produced by BEHR; W 200 mm Diameter 1 [mm]: 18; Diameter 2 [mm]: 18; Diameter 3 [mm]: 10; Diameter 4 [mm]: 12; + OE 81.61967.0020; R 134a	8FV 351 336-111	409
19.400 FS/M-WW, FLS/M-WW, FRS/M-WW, FLRS/M-WW	294 kW		02/11→		Evaporator, air conditioning	
19.440 FS-WW, FRS-WW, FLS-WW, FLRS-WW	324 kW		02/11→		8UW 351 336-161	410
19.480 FS/M-WW, FRS/M-WW, FLS/M-WW, FLRS/M-WW	353 kW		02/11→		Expansion Valve, air conditioning	
40.400 FDAK-WW, FDARK-WW	294 kW		02/11→			
40.400 FDAS-WW, FDARS-WW	294 kW		02/11→			
40.440 FDAK-WW, FDARK-WW	324 kW		02/11→			
40.440 FDAS-WW, FDARS-WW	324 kW		02/11→			
24.320 FNLLW/N	235 kW		10/07→		Depth [mm]: 16; L 750 mm; without dehumidifier; Vers. produced by BEHR; W 351 mm	8FC 351 300-121
24.360 FNLLW/N	265 kW		10/07→	Condenser, air conditioning		
24.360 FPLS, FPLRS	265 kW		10/07→	Compressor ID: SD7H15; Manufacturer Restriction: Sanden; New Part: 1; Number of Ribs: 8	8FK 351 135-141	402
24.400 FNLLW/N	294 kW		10/07→		Compressor, air conditioning	
24.400 FPLS, FPLRS	294 kW		10/07→	Compressor ID: SD7H15; Manufacturer Restriction: Sanden; Number of Ribs: 8	8FK 351 135-641	403
24.440 FNLLW/N	324 kW		10/07→		Compressor, air conditioning BEHR	
24.440 FPLS, FPLRS	324 kW		10/07→		HELLA SERVICE	
24.480 FPLS, FPLRS	353 kW		10/07→		Version ALTERNATIVE	
24.540 FPLS, FPLRS	397 kW		10/07→		8FT 351 197-481	408
28.320 FNHLC	235 kW		07/08→	Depth [mm]: 65; L 307 mm; with expansion valve; Vers. produced by BEHR; W 200 mm		
28.320 FNLC	235 kW		07/08→		Evaporator, air conditioning	
28.320 FNLS	235 kW		07/08→	Diameter 1 [mm]: 18; Diameter 2 [mm]: 18; Diameter 3 [mm]: 10; Diameter 4 [mm]: 12; + OE 81.61967.0020; R 134a	8FV 351 336-111	409
28.360 FANLC, FNHLC	265 kW		08/08→		Expansion Valve, air conditioning	
28.360 FANLK	265 kW		08/08→			
28.360 FNLC	265 kW		08/08→			
28.360 FNLS	265 kW		08/08→			
28.400 FANLC, FNHLC	294 kW		08/08→			
28.400 FANLK	294 kW		08/08→			
28.400 FNLC	294 kW		08/08→			
28.400 FNLS	294 kW		08/08→			
28.440 FANLC, FNHLC	324 kW		08/08→			
28.440 FANLK	324 kW		08/08→			
28.440 FNLC	324 kW		08/08→			
28.440 FNLS	324 kW		08/08→			
28.480 FANLC, FNHLC	353 kW		08/08→			
28.480 FANLK	353 kW		08/08→			
28.480 FNLC	353 kW		08/08→			
28.480 FNLS	353 kW		08/08→			
28.540 FNHLC	397 kW		06/08→			
28.540 FNLC	397 kW		02/09→			
28.540 FNLS	397 kW		02/09→			
33.360 FDAC, FDALC	265 kW		06/08→			
33.360 FDAK, FDALK, FDHK	265 kW		10/07→			
33.360 FDAS, FDALS, FDHS	265 kW		10/07→			
33.360 FDC, FDLC	265 kW		06/08→			
33.360 FDK, FDLK	265 kW		02/09→			
33.360 FDS, FDLS	265 kW		06/08→			
33.400 FDAC, FDALC	294 kW		07/08→			
33.400 FDAK, FDALK, FDHK	294 kW		07/08→			
33.400 FDAS, FDALS, FDHS	294 kW		07/08→			
33.400 FDC, FDLC	294 kW		06/08→			
33.400 FDK, FDLK	294 kW		07/08→			
33.400 FDS, FDLS	294 kW		07/08→			
33.440 FDAC, FDALC	324 kW		07/08→			
33.440 FDAK, FDALK, FDHK	324 kW		11/07→			
33.440 FDAS, FDALS, FDHS	324 kW		10/07→			
33.440 FDC, FDLC	324 kW		06/08→			
33.440 FDK, FDLK	324 kW		06/08→			
33.440 FDS, FDLS, FDLS/M	324 kW		06/08→			
33.480 FDAC, FDALC	353 kW		08/08→			
33.480 FDAK, FDALK	353 kW		08/08→			
33.480 FDAS, FDALS, FDHS	353 kW		10/07→			
33.480 FDC, FDC/M, FDLC, FDLC/M	353 kW		08/08→			
33.480 FDK, FDLK	353 kW		08/08→			
33.480 FDS, FDLS, FDLS/M	353 kW		08/08→			
33.540 FDAC, FDALC	397 kW		02/09→			
33.540 FDAK, FDALK	397 kW		02/09→			
33.540 FDAS, FDALS	397 kW		02/09→			
33.540 FDC, FDLC, FDLC/M	397 kW		02/09→			
33.540 FDK, FDLK	397 kW		02/09→			
33.540 FDS, FDLS, FDLS/M	397 kW		02/09→			
37.320 FFDC	235 kW		07/08→			
37.320 FFDK	235 kW		07/08→			
37.320 FFD-TM	235 kW		10/07→			
37.360 FFDC	265 kW		07/08→			
37.360 FFDK	265 kW		07/08→			
37.360 FFD-TM	265 kW		10/07→			
37.400 FFDC	294 kW		07/08→			

Manufacturer - Model	Power	Displ.	Year of Constr.	Remark	Part Number	Page
MAN - TGS						09/07→
37.400 FFDK	294 kW		07/08→	Depth [mm]: 16; L 750 mm; without dehumidifier; Vers. produced by BEHR; W 351 mm	8FC 351 300-121	405
37.400 FFD-TM	294 kW		10/07→		Condenser, air conditioning	
37.440 FFDC	324 kW		07/08→	Compressor ID: SD7H15; Manufacturer Restriction: Sanden; New Part: 1; Number of Ribs: 8	8FK 351 135-141	402
37.440 FFDK	324 kW		07/08→		Compressor, air conditioning	
37.440 FFD-TM	324 kW		10/07→	Compressor ID: SD7H15; Manufacturer Restriction: Sanden; Number of Ribs: 8	8FK 351 135-641	403
37.480 FFDC	353 kW		07/08→		Compressor, air conditioning BEHR	
37.480 FFDK	353 kW		07/08→	HELLA SERVICE	Version ALTERNATIVE	
37.480 FFD-TM	353 kW		10/07→			
37.540 FFDC	397 kW		02/09→	HELLA SERVICE	Version ALTERNATIVE	
37.540 FFDK	397 kW		02/09→			
37.540 FFD-TM	397 kW		10/07→			
41.320 FFDAK	235 kW		06/08→		8FT 351 197-481	408
41.360 FFDAK	265 kW		06/08→		air conditioning	
41.360 FFDC	265 kW		07/08→	Depth [mm]: 65; L 307 mm; with expansion valve; Vers. produced by BEHR; W 200 mm	8FV 351 336-111	409
41.360 FFDK	265 kW		07/08→		Evaporator, air conditioning	
41.360 FFD-TM	265 kW		10/07→	Diameter 1 [mm]: 18; Diameter 2 [mm]: 18; Diameter 3 [mm]: 10; Diameter 4 [mm]: 12; + OE 81.61967.0020; R 134a	8UW 351 336-161	410
41.400 FFDC	294 kW		07/08→		Expansion Valve, air conditioning	
41.400 FFDK	294 kW		07/08→			
41.400 FFD-TM	294 kW		10/07→			
41.440 FFDAK	324 kW		06/08→			
41.440 FFDC	324 kW		07/08→			
41.440 FFDK	324 kW		07/08→			
41.440 FFD-TM	324 kW		10/07→			
41.480 FFDAK	353 kW		06/08→			
41.480 FFDARC	353 kW		06/08→			
41.480 FFDC	353 kW		07/08→			
41.480 FFDK	353 kW		07/08→			
41.480 FFD-TM	353 kW		10/07→			
41.540 FFDAK	397 kW		02/09→			
41.540 FFDC	397 kW		02/09→			
41.540 FFDK	397 kW		02/09→			
41.540 FFD-TM	397 kW		10/07→			
MAN - TGX						09/07→
18.360 FHLC	265 kW		10/07→	Depth [mm]: 16; L 750 mm; without dehumidifier; Vers. produced by BEHR; W 351 mm	8FC 351 300-121	405
18.360 FHLS, FHLS/M	265 kW		10/07→		Condenser, air conditioning	
18.360 FLC, FLRC, FLLC, FLLRC, FLLW, FLLW/N	265 kW		10/07→	Depth [mm]: 16; Inner Diameter 1 [mm]: 14.35; Inner Diameter 2 [mm]: 11.05; L 765 mm; with dryer; Vers. produced by BEHR; W 351 mm	8FC 351 319-471	407
18.360 FLS, FLS/M, FLRS, FLRS/N, FLLS, FLLS/N, FLLRS, FLLRS/N	265 kW		10/07→		Condenser, air conditioning	
18.400 FHLC	294 kW		10/07→	Compressor ID: SD7H15; Manufacturer Restriction: Sanden; New Part: 1; Number of Ribs: 8	8FK 351 135-141	402
18.400 FHLS, FHLS/M	294 kW		10/07→		Compressor, air conditioning	
18.400 FLC, FLRC, FLLC, FLLRC, FLLW, FLLW/N	294 kW		10/07→	Compressor ID: SD7H15; Manufacturer Restriction: Sanden; Number of Ribs: 8	8FK 351 135-641	403
18.400 FLS, FLS/M, FLRS, FLRS/N, FLLS, FLLS/N, FLLRS, FLLRS/N	294 kW		10/07→		Compressor, air conditioning BEHR	
18.440 FHLC	324 kW		10/07→	HELLA SERVICE	Version ALTERNATIVE	
18.440 FHLS, FHLS/M	324 kW		10/07→			
18.440 FLC, FLRC, FLLC, FLLRC, FLLW, FLLW/N	324 kW		10/07→	Ø 37.1 mm; L 400 mm	8FT 351 193-201	408
18.440 FLS, FLS/M, FLRS, FLRS/M, FLLS, FLLS/N, FLLRS, FLLRS/N	324 kW		10/07→		air conditioning	
18.440 FLS, FLS/M, FLRS, FLRS/N, FLLS, FLLS/N, FLLRS, FLLRS/N	324 kW		10/07→		8FT 351 197-481	408
18.480 FHLC	353 kW		10/07→	Depth [mm]: 65; L 307 mm; with expansion valve; Vers. produced by BEHR; W 200 mm	8FV 351 336-111	409
18.480 FHLS, FHLS/M	353 kW		10/07→		Evaporator, air conditioning	
18.480 FLC, FLRC, FLLC, FLLRC, FLLW, FLLW/N	353 kW		10/07→	Diameter 1 [mm]: 18; Diameter 2 [mm]: 18; Diameter 3 [mm]: 10; Diameter 4 [mm]: 12; + OE 81.61967.0020; R 134a	8UW 351 336-161	410
18.480 FLS, FLS/M, FLRS, FLRS/N, FLLS, FLLS/N, FLLRS, FLLRS/N	353 kW		10/07→		Expansion Valve, air conditioning	
18.540 FHLC	397 kW		10/07→			
18.540 FHLS, FHLS/M	397 kW		10/07→			
18.540 FLC, FLRC, FLLC, FLLRC, FLLW, FLLW/N	397 kW		10/07→			
18.540 FLS, FLS/M, FLRS, FLRS/N, FLLS, FLLS/N, FLLRS, FLLRS/N	397 kW		10/07→			
26.320 FNLS, FNLLS	235 kW		10/07→			
26.360 FDC, FDLC, FDRC, FDLRC	265 kW		07/08→			
26.360 FDHLC	265 kW		10/07→			
26.360 FDHLS	265 kW		10/07→			
26.360 FDS, FDLS, FDRS, FDLRS	265 kW		07/08→			
26.360 FNHLC	265 kW		10/07→			
26.360 FNHLS	265 kW		12/07→			
26.360 FNLC, FNLRC, FNLLC, FNLLRC, FNLLW	265 kW		10/07→			

Manufacturer - Model	Power	Displ.	Year of Constr.	Remark	Part Number	Page
MAN - TGX						09/07→
26.360 FNLS, FNLLS, FNLRs, FNLLRS, FPLS, FPLRS, FVLS	265 kW		10/07→	Depth [mm]: 16; L 750 mm; without dehumidifier; Vers. produced by BEHR; W 351 mm	8FC 351 300-121 Condenser, air conditioning	405
26.360 FVHLS	265 kW		05/08→			
26.400 FDC, FDLC, FDRC, FDLRC	294 kW		07/08→	Depth [mm]: 16; Inner Diameter 1 [mm]: 14.35; Inner Diameter 2 [mm]: 11.05; L 765 mm; with dryer; Vers. produced by BEHR; W 351 mm	8FC 351 319-471 Condenser, air conditioning	407
26.400 FDHLC	294 kW		10/07→			
26.400 FDHLS	294 kW		10/07→			
26.400 FDS, FDLS, FDRS, FDLRS	294 kW		07/08→	Compressor ID: SD7H15; Manufacturer Restriction: Sanden; New Part: 1; Number of Ribs: 8	8FK 351 135-141 Compressor, air conditioning	402
26.400 FNHLC	294 kW		12/07→			
26.400 FNHLS	294 kW		12/07→	Compressor ID: SD7H15; Manufacturer Restriction: Sanden; Number of Ribs: 8	8FK 351 135-641 Compressor, air conditioning BEHR HELLA SERVICE Version ALTERNATIVE	403
26.400 FNLC, FNLRc, FNLLC, FNLLRC, FNLLW	294 kW		10/07→			
26.400 FNLS, FNLLS, FNLRs, FNLLRS, FPLS, FPLRS, FVLS	294 kW		10/07→			
26.400 FPHLS	294 kW		05/08→	Ø 37.1 mm; L 400 mm	8FT 351 193-201 Dryer, air conditioning	408
26.400 FVHLS	294 kW		05/08→			
26.440 FDC, FDLC, FDRC, FDLRC	324 kW		07/08→		8FT 351 197-481 Dryer, air conditioning	408
26.440 FDHLC	324 kW		09/07→			
26.440 FDHLS	324 kW		10/07→	Depth [mm]: 65; L 307 mm; with expansion valve; Vers. produced by BEHR; W 200 mm	8FV 351 336-111 Evaporator, air conditioning	409
26.440 FDS, FDLS, FDRS, FDLRS	324 kW		07/08→			
26.440 FNHLC	324 kW		12/07→			
26.440 FNHLS	324 kW		12/07→			
26.440 FNLC, FNLRc, FNLLC, FNLLRC, FNLLW	324 kW		10/07→	Diameter 1 [mm]: 18; Diameter 2 [mm]: 18; Diameter 3 [mm]: 10; Diameter 4 [mm]: 12; + OE 81.61967.0020; R 134a	8UW 351 336-161 Expansion Valve, air conditioning	410
26.440 FNLS, FNLLS, FNLRs, FNLLRS, FPLS, FPLRS, FVLS	324 kW		10/07→			
26.440 FPHLS	324 kW		05/08→			
26.440 FVHLS	324 kW		05/08→			
26.480 FDC, FDLC, FDRC, FDLRC	353 kW		07/08→			
26.480 FDHLC	353 kW		09/07→			
26.480 FDHLS	353 kW		10/07→			
26.480 FDS, FDLS, FDRS, FDLRS	353 kW		07/08→			
26.480 FNHLC	353 kW		12/07→			
26.480 FNHLS	353 kW		12/07→			
26.480 FNLC, FNLRc, FNLLC, FNLLRC, FNLLW	353 kW		10/07→			
26.480 FNLS, FNLLS, FNLRs, FNLLRS, FPLS, FPLRS, FVLS	353 kW		10/07→			
26.480 FPHLS	353 kW		05/08→			
26.480 FVHLS	353 kW		05/08→			
26.540 FDC, FDLC, FDRC, FDLRC	397 kW		02/09→			
26.540 FDS, FDLS, FDRS, FDLRS	397 kW		02/09→			
26.540 FNLC, FNLRc, FNLLC, FNLLRC, FNLLW	397 kW		10/07→			
26.540 FNLS, FNLRs, FNLLS, FPLS, FPLRS, FVLS	397 kW		10/07→			
33.360 FDC, FDC/M, FDLC	265 kW		10/07→			
33.360 FDS, FDS/M, FDLS, FDLS/M	265 kW		10/07→			
33.400 FDC, FDC/M, FDLC	294 kW		10/07→			
33.400 FDS, FDS/M, FDLS, FDLS/M	294 kW		10/07→			
33.440 FDC, FDC/M, FDLC	324 kW		10/07→			
33.440 FDS, FDS/M, FDLS, FDLS/M	324 kW		10/07→			
33.480 FDC, FDC/M, FDLC	353 kW		10/07→			
33.480 FDS, FDS/M, FDLS, FDLS/M	353 kW		10/07→			
33.540 FDC, FDC/M, FDLC	397 kW		10/07→			
33.540 FDS, FDS/M, FDLS, FDLS/M	397 kW		10/07→			
18.440 FLRC	324 kW		10/07→	Depth [mm]: 16; Inner Diameter 1 [mm]: 14.35; Inner Diameter 2 [mm]: 11.05; L 765 mm; with dryer; Vers. produced by BEHR; W 351 mm	8FC 351 319-471 Condenser, air conditioning	407
18.440 FLRS	324 kW		10/07→			
26.440 FPLRS	324 kW		07/08→	Ø 37.1 mm; L 400 mm	8FT 351 193-201 Dryer, air conditioning	408
				Depth [mm]: 65; L 307 mm; with expansion valve; Vers. produced by BEHR; W 200 mm	8FV 351 336-111 Evaporator, air conditioning	409
				Diameter 1 [mm]: 18; Diameter 2 [mm]: 18; Diameter 3 [mm]: 10; Diameter 4 [mm]: 12; + OE 81.61967.0020; R 134a	8UW 351 336-161 Expansion Valve, air conditioning	410

Manufacturer - Model	Power	Displ.	Year of Constr.	Remark	Part Number	Page
MAN - TGX						09/07→
18.680 FLS	500 kW		10/07→	Depth [mm]: 65; L 307 mm; with expansion valve; Vers. produced by BEHR; W 200 mm	8FV 351 336-111	409
24.440 FPLRS	324 kW		10/07→		Diameter 1 [mm]: 18; Diameter 2 [mm]: 18; Diameter 3 [mm]: 10; Diameter 4 [mm]: 12; + OE 81.61967.0020; R 134a	Evaporator, air conditioning
33.680 FDLC	500 kW		10/07→	Diameter 1 [mm]: 18; Diameter 2 [mm]: 18; Diameter 3 [mm]: 10; Diameter 4 [mm]: 12; + OE 81.61967.0020; R 134a		8UW 351 336-161
33.680 FDLS	500 kW		10/07→		Diameter 1 [mm]: 18; Diameter 2 [mm]: 18; Diameter 3 [mm]: 10; Diameter 4 [mm]: 12; + OE 81.61967.0020; R 134a	Expansion Valve, air conditioning
41.680 FVDS, FVDLS	500 kW		10/07→	Depth [mm]: 16; L 750 mm; without dehumidifier; Vers. produced by BEHR; W 351 mm		8FC 351 300-121
24.360 FNLLW/N	265 kW		10/07→		Compressor ID: SD7H15; Manufacturer Restriction: Sanden; New Part: 1; Number of Ribs: 8	Condenser, air conditioning
24.360 FPLS, FPLRS	265 kW		10/07→	Compressor ID: SD7H15; Manufacturer Restriction: Sanden; Number of Ribs: 8		8FK 351 135-141
24.400 FNLLW/N	294 kW		10/07→		Compressor ID: SD7H15; Manufacturer Restriction: Sanden; Number of Ribs: 8	Compressor, air conditioning
24.400 FPLS, FPLRS	294 kW		10/07→	Compressor ID: SD7H15; Manufacturer Restriction: Sanden; Number of Ribs: 8		8FK 351 135-641
24.440 FNLLW/N	324 kW		10/07→		Compressor ID: SD7H15; Manufacturer Restriction: Sanden; Number of Ribs: 8	Compressor, air conditioning BEHR
24.440 FPLS, FPLRS	324 kW		10/07→	Compressor ID: SD7H15; Manufacturer Restriction: Sanden; Number of Ribs: 8		HELLA SERVICE
24.480 FNLLW/N	353 kW		10/07→		Compressor ID: SD7H15; Manufacturer Restriction: Sanden; Number of Ribs: 8	Version ALTERNATIVE
24.480 FPLS, FPLRS	353 kW		10/07→	Compressor ID: SD7H15; Manufacturer Restriction: Sanden; Number of Ribs: 8		8FT 351 197-481
24.540 FNLLW/N	397 kW		02/09→		Compressor ID: SD7H15; Manufacturer Restriction: Sanden; Number of Ribs: 8	Dryer, air conditioning
24.540 FPLS, FPLRS	397 kW		10/07→	Compressor ID: SD7H15; Manufacturer Restriction: Sanden; Number of Ribs: 8		8FV 351 336-111
28.360 FNLC	265 kW		10/07→		Compressor ID: SD7H15; Manufacturer Restriction: Sanden; Number of Ribs: 8	Evaporator, air conditioning
28.360 FNLS	265 kW		10/07→	Compressor ID: SD7H15; Manufacturer Restriction: Sanden; Number of Ribs: 8		8UW 351 336-161
28.400 FNLC	294 kW		10/07→		Compressor ID: SD7H15; Manufacturer Restriction: Sanden; Number of Ribs: 8	Expansion Valve, air conditioning
28.400 FNLS	294 kW		10/07→	Compressor ID: SD7H15; Manufacturer Restriction: Sanden; Number of Ribs: 8		
28.440 FNLC	324 kW		10/07→		Compressor ID: SD7H15; Manufacturer Restriction: Sanden; Number of Ribs: 8	
28.440 FNLS	324 kW		10/07→	Compressor ID: SD7H15; Manufacturer Restriction: Sanden; Number of Ribs: 8		
28.480 FNLC	353 kW		10/07→		Compressor ID: SD7H15; Manufacturer Restriction: Sanden; Number of Ribs: 8	
28.480 FNLS	353 kW		10/07→	Compressor ID: SD7H15; Manufacturer Restriction: Sanden; Number of Ribs: 8		
28.540 FNLC	397 kW		10/07→		Compressor ID: SD7H15; Manufacturer Restriction: Sanden; Number of Ribs: 8	
28.540 FNLS	397 kW		02/09→	Compressor ID: SD7H15; Manufacturer Restriction: Sanden; Number of Ribs: 8		
35.360 FDNLC	265 kW		06/08→		Compressor ID: SD7H15; Manufacturer Restriction: Sanden; Number of Ribs: 8	
35.400 FDNLC	294 kW		06/08→	Compressor ID: SD7H15; Manufacturer Restriction: Sanden; Number of Ribs: 8		
35.440 FDNLC	324 kW		06/08→		Compressor ID: SD7H15; Manufacturer Restriction: Sanden; Number of Ribs: 8	
35.480 FDNLC	353 kW		06/08→	Compressor ID: SD7H15; Manufacturer Restriction: Sanden; Number of Ribs: 8		
35.540 FDNLC	397 kW		06/08→		Compressor ID: SD7H15; Manufacturer Restriction: Sanden; Number of Ribs: 8	
41.540 FVDS, FVDLS	397 kW		06/08→	Compressor ID: SD7H15; Manufacturer Restriction: Sanden; Number of Ribs: 8		

BMW	HELLA
64 50 6 935 921	8FT 351 198-481
6 935 921	8FT 351 198-481
CLAAS	HELLA
062 586 40	8UW 351 234-041
DAF	HELLA
133 1998	8UW 351 239-381
MAN	HELLA
51.77970.7011	8FK 351 119-361
51.77970.7014	8FK 351 119-361
51.77970.7015	8FK 351 135-231
51.77970.7025	8FK 351 119-361
51.77970.7026	8FK 351 135-231
51.77970.7028	8FK 351 135-141
51.77970.7028	8FK 351 135-641
81.61906.6012	8FK 351 135-141
81.61906.6012	8FK 351 135-641
81.61910.6039	8FT 351 198-481
81.61910.6045	8FT 351 197-481
81.61910.6049	8FT 351 193-201
81.61920.0017	8FC 351 306-061
81.61920.0024	8FC 351 029-371
81.61920.0027	8FC 351 300-121
81.61920.0029	8FC 351 300-121
81.61920.0032	8FC 351 300-121
81.61920.0035	8FC 351 319-471
81.61920.0036	8FC 351 029-371
81.61920.6028	8FC 351 306-071
81.61920.6036	8FV 351 336-111
81.61967.0020	8UW 351 336-161
81 61910 6017	8FT 351 197-481
81 61910 6023	8FT 351 197-481
81 61920 0011	8FC 351 317-611
81 61920 0012	8FC 351 300-061
81 61920 0018	8FC 351 300-121
81 61920 0023	8FC 351 300-121
81 61920 0030	8FC 351 300-121
81 61920 6019	8FC 351 300-071
81 61920 6026	8FC 351 300-071
81 61920 6032	8FV 351 330-111
81 61967 0008	8UW 351 234-041
81 61967 0010	8UW 351 234-041
81 61967 0014	8UW 351 239-381
85.61920.0004	8FC 351 301-021
85.61920.1002	8FC 351 301-021
MERCEDES- BENZ	HELLA
001 830 05 84	8UW 351 234-041
002 830 09 84	8UW 351 239-381
451 835 01 47	8FT 351 198-481
A 001 830 05 84	8UW 351 234-041
A 002 830 09 84	8UW 351 239-381
A 451 835 01 47	8FT 351 198-481
SMART	HELLA
451 835 01 47	8FT 351 198-481
VOLVO	HELLA
1 697 376	8UW 351 234-041
8 150 187	8UW 351 234-041

8FC ...

8FC 351 029-371	404
8FC 351 300-061	404
8FC 351 300-071	405
8FC 351 300-121	405
8FC 351 301-021	405
8FC 351 306-061	406
8FC 351 306-071	406
8FC 351 317-611	406
8FC 351 319-471	407

8FK ...

8FK 351 119-361	401
8FK 351 126-201	401
8FK 351 135-141	402
8FK 351 135-231	402
8FK 351 135-641	403

8FT ...

8FT 351 193-201	408
8FT 351 197-481	408
8FT 351 198-481	408

8FV ...

8FV 351 330-111	409
8FV 351 336-111	409

8UW ...

8UW 351 234-041	410
8UW 351 239-381	410
8UW 351 336-161	410

Control Valve, coolant.....	458
Heat Exchanger, interior heating.....	455
Interior Blower.....	452
Regulator, passenger compartment fan.....	456
Resistor, interior blower.....	457

Fan - Interior Blower

8EW 009 158-151
BEHR HELLA SERVICE



Rated Power [W]	300
Rated Voltage [V]	24
Supplementary Article/Supplementary Info	with integrated regulator
Version	produced by BEHR

Spare Parts



1 x 5HL 351 029-061 Regulator, passenger compartment fan

8EW 009 158-481
BEHR HELLA SERVICE

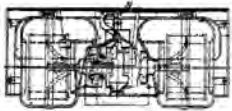

Depth [mm]	133
Housing Type	with housing
Length [mm]	350
Rated Power [W]	216
Rated Voltage [V]	24
Supplementary Article/Supplementary Info	with integrated regulator
Version	produced by BEHR
Width [mm]	143

Fan - Interior Blower

8EW 009 160-021
BEHR HELLA SERVICE

Without box
without blower regulator

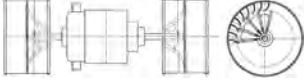

Diameter [mm]	100
Length [mm]	278
Mounting Diameter [mm]	72
Rated Power [W]	276
Rated Voltage [V]	24
Version	produced by BEHR

8EW 009 160-341
BEHR HELLA SERVICE

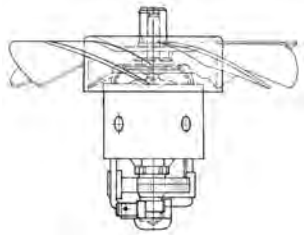

for OE number	81619306037
Rated Voltage [V]	24
Version	produced by BEHR

8EW 009 160-371
BEHR HELLA SERVICE

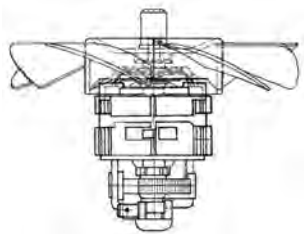

Diameter [mm]	146
for OE number	81619306036
Rated Voltage [V]	24
Version	produced by BEHR

Fan - Interior Blower

8EW 009 160-491
BEHR HELLA SERVICE

Without box
without blower regulator

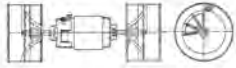

Diameter [mm]	100
Length [mm]	278
Mounting Diameter [mm]	59
Rated Voltage [V]	24
Version	produced by BEHR

8EW 009 160-791
BEHR HELLA SERVICE

with box

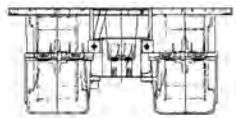

Depth [mm]	158
Length [mm]	330
Rated Current [A]	12.5
Rated Power [W]	300
Rated Voltage [V]	24
Supplementary Article/Supplementary Info 2	without cable
Version	produced by BEHR
Width [mm]	185

Spare Parts



1 x 8EW 009 160-641 Interior Blower

Heat Exchanger, interior heating

8FH 351 312-241
BEHR HELLA SERVICE

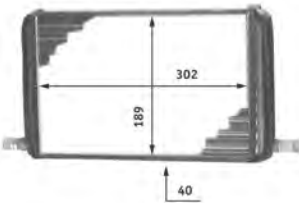

Depth [mm]	40
Length [mm]	189
Vehicle Equipment	for vehicles with/without air conditioning
Version	produced by BEHR
Width [mm]	302

8FH 351 312-361
BEHR HELLA SERVICE

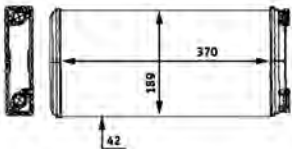

Depth [mm]	42
Length [mm]	370
Vehicle Equipment	for vehicles with air conditioning
Version	produced by BEHR
Width [mm]	189

8FH 351 312-421
BEHR HELLA SERVICE

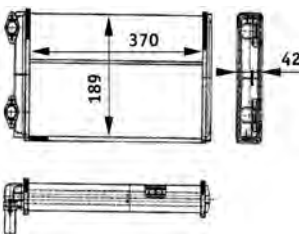

Depth [mm]	42	Version	produced by BEHR
Length [mm]	370	Width [mm]	189
Vehicle Equipment	for vehicles with/without air conditioning		

Heat Exchanger, interior heating

8FH 351 312-441
BEHR HELLA SERVICE

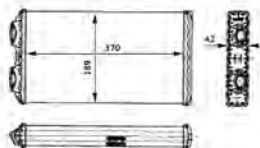

Depth [mm]	42
Length [mm]	370
Vehicle Equipment	for vehicles with/without air conditioning
Version	produced by BEHR
Width [mm]	189

8FH 351 312-551
BEHR HELLA SERVICE

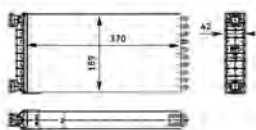

Depth [mm]	42
for OE number	81619016166
Length [mm]	370
Vehicle Equipment	for vehicles with/without air conditioning
Version	produced by BEHR
Width [mm]	189

Regulator, passenger compartment fan

5HL 351 029-061
BEHR HELLA SERVICE

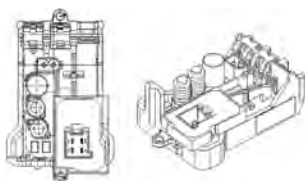

Number of Poles	4
-----------------	---

Resistor, interior blower

9ML 351 029-111
BEHR HELLA SERVICE



Depth [mm]	21
Length [mm]	60
Number of Poles	3
Width [mm]	22

9ML 351 332-121
BEHR HELLA SERVICE



for OE number	81259070186
---------------	-------------

9ML 351 332-151
BEHR HELLA SERVICE

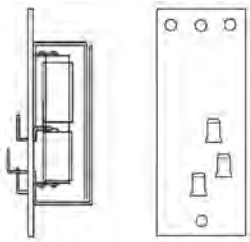

for OE number	81259070187
---------------	-------------

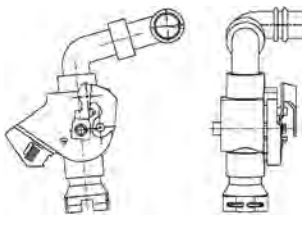
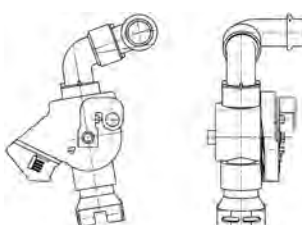
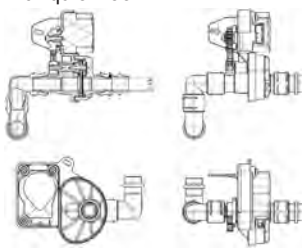
Valve - Control Valve, coolant	
9XL 351 029-071 _BEHR HELLA SERVICE_	
	
Valve Type	Control Valve
9XL 351 341-041 _BEHR HELLA SERVICE_	
	
Exhaust Emission Norm	Euro 5
Operating Mode	Mechanical
Valve Type	Stop Valve
Vehicle Equipment	for vehicles without air conditioning
Version	produced by BEHR
9XL 351 341-051 _BEHR HELLA SERVICE_	
with quick lock 	
Exhaust Emission Norm	Euro 5
Operating Mode	Mechanical
Valve Type	Stop Valve
Vehicle Equipment	for vehicles with air conditioning
Version	produced by BEHR

Valve - Control Valve, coolant

9XL 351 341-061
BEHR HELLA SERVICE

with quick lock

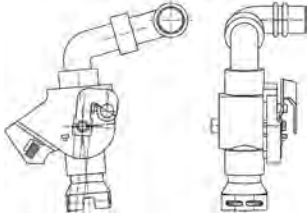

Exhaust Emission Norm	Euro 4 (D4)
Operating Mode	Mechanical
Valve Type	Stop Valve
Vehicle Equipment	for vehicles without air conditioning
Version	produced by BEHR

9XL 351 341-071
BEHR HELLA SERVICE

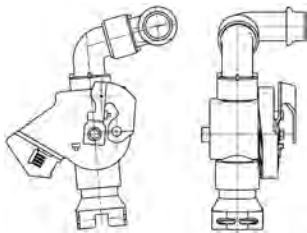

Version	produced by BEHR
---------	------------------



MAN.....461

Manufacturer - Model	Power	Displ.	Year of Constr.	Remark	Part Number	Page
MAN - Cab-over Trucks						07/86→05/94
19.322 U, 19.322 UL, 19.322 ULL	235 kW		02/90→05/94	Mounting Diameter [mm]: 59; Vers. produced by BEHR	8EW 009 160-491 Interior Blower	454
19.372 U, 19.372 ULL	272 kW		02/90→05/94			
19.422 U, 19.422 ULL	309 kW		02/90→05/94	Vers. produced by BEHR	8FH 351 312-361 Heat Exchanger, interior heating	455
24.322 UNL, 24.322 UNLL	235 kW		02/90→12/90			
25.322 UNL, 25.322 UNLL	235 kW		09/90→12/92			
26.322 UNL, 26.322 UNLL	235 kW		09/90→05/94	+ OE 81259070186	9ML 351 332-121 Resistor, interior blower	457
26.372 UNL, 26.372 UNLL	272 kW		09/90→05/94	+ OE 81259070187	9ML 351 332-151 Resistor, interior blower	457
19.332 U, 19.322 UL, 19.322 ULL	243 kW		07/86→02/90	+ OE 8157216 / + OE 81619300042; Vers. produced by BEHR	8EW 009 160-021 Interior Blower	453
				Mounting Diameter [mm]: 59; Vers. produced by BEHR	8EW 009 160-491 Interior Blower	454
				+ OE 81619306064; 24 V; Vers. produced by BEHR	8EW 009 160-791 Interior Blower	454
				Vers. produced by BEHR	8FH 351 312-361 Heat Exchanger, interior heating	455
				+ OE 81259070186	9ML 351 332-121 Resistor, interior blower	457
				+ OE 81259070187	9ML 351 332-151 Resistor, interior blower	457
19.362 U, 19.362 UL, 19.362 ULL	265 kW		07/86→01/91	+ OE 8157216 / + OE 0018300208 / + OE A0018300208 / + OE 81619300042; Vers. produced by BEHR	8EW 009 160-021 Interior Blower	453
				Mounting Diameter [mm]: 59; Vers. produced by BEHR	8EW 009 160-491 Interior Blower	454
				+ OE 81619306064; 24 V; Vers. produced by BEHR	8EW 009 160-791 Interior Blower	454
				Vers. produced by BEHR	8FH 351 312-361 Heat Exchanger, interior heating	455
				+ OE 81259070186	9ML 351 332-121 Resistor, interior blower	457
				+ OE 81259070187	9ML 351 332-151 Resistor, interior blower	457
24.332 UNL, 24.332 UNLL	243 kW		10/86→02/90	+ OE 0008309308 / + OE A0008309308 / + OE 1294099 / + OE 81619300036; →08/87; with housing; Rated Power [W]: 216; 24 V; with integrated regulator; Vers. produced by BEHR	8EW 009 158-481 Interior Blower	452
24.362 UNL, 24.362 UNLL	265 kW		10/86→02/90			
				+ OE 8157216 / + OE 0018300208 / + OE A0018300208 / + OE 81619300042; Vers. produced by BEHR	8EW 009 160-021 Interior Blower	453
				+ OE 81619306037; 24 V; Vers. produced by BEHR	8EW 009 160-341 Interior Blower	453
				Ø 146 mm; + OE 81619306036; 24 V; Vers. produced by BEHR	8EW 009 160-371 Interior Blower	453
				Mounting Diameter [mm]: 59; Vers. produced by BEHR	8EW 009 160-491 Interior Blower	454
				+ OE 81619306064; 24 V; Vers. produced by BEHR	8EW 009 160-791 Interior Blower	454
				Vers. produced by BEHR	8FH 351 312-361 Heat Exchanger, interior heating	455
				+ OE 81259070186	9ML 351 332-121 Resistor, interior blower	457
				+ OE 81259070187	9ML 351 332-151 Resistor, interior blower	457
24.372 UNL, 24.372 UNLL	272 kW		02/90→12/90	+ OE 81619306037; 24 V; Vers. produced by BEHR	8EW 009 160-341 Interior Blower	453
24.422 UNL, 24.422 UNLL	309 kW		02/90→12/90			
25.372 UNL, 25.372 UNLL	272 kW		09/90→12/92	Ø 146 mm; + OE 81619306036; 24 V; Vers. produced by BEHR	8EW 009 160-371 Interior Blower	453
25.422 UNL, 25.422 UNLL	309 kW		09/90→12/92	Mounting Diameter [mm]: 59; Vers. produced by BEHR	8EW 009 160-491 Interior Blower	454
				Vers. produced by BEHR	8FH 351 312-361 Heat Exchanger, interior heating	455
				+ OE 81259070186	9ML 351 332-121 Resistor, interior blower	457
				+ OE 81259070187	9ML 351 332-151 Resistor, interior blower	457

Manufacturer - Model	Power	Displ.	Year of Constr.	Remark	Part Number	Page
MAN - Cab-over Trucks						07/86→05/94
26.422 UNL,26.422 UNLL	309 kW		09/90→05/94	Mounting Diameter [mm]: 59; Vers. produced by BEHR	8EW 009 160-491 Interior Blower	454
				+ OE 81259070186	9ML 351 332-121 Resistor, interior blower	457
				+ OE 81259070187	9ML 351 332-151 Resistor, interior blower	457
MAN - E 2000						05/00→
26.410 DFARC	301 kW		05/00→		9ML 351 029-111 Resistor, interior blower	457
26.410 DFRC, FAVLC	301 kW		05/00→			
26.460 DFARC	338 kW		05/00→			
26.460 DFLRS	338 kW		05/00→			
30.360 FANLC	265 kW		05/00→			
30.360 FANLK	265 kW		05/00→			
30.410 FANLC	301 kW		05/00→			
30.410 FANLK	301 kW		05/00→			
30.460 FANLC	338 kW		05/00→			
30.460 FANLK	338 kW		05/00→			
32.410 VFARK	301 kW		05/00→			
33.360 DFALC	265 kW		05/00→			
33.360 DFALS	265 kW		04/01→			
33.410 DFALC	301 kW		05/00→			
33.410 DFALS	301 kW		04/01→			
33.460 DFAK, DFALK	338 kW		05/00→			
33.460 DFALC	338 kW		05/00→			
33.460 DFALS	338 kW		04/01→			
MAN - EM						08/87→
EM 192	140 kW		10/93→06/97	Depth [mm]: 42; L 370 mm; for vehicles with/without air conditioning; Vers. produced by BEHR; W 189 mm	8FH 351 312-421 Heat Exchanger, interior heating	455
EM 223	162 kW		08/87→			
MAN - F 90						07/86→12/97
19.242 F,19.242 FL,19.242 FLL	177 kW		01/88→01/89	Mounting Diameter [mm]: 59; Vers. produced by BEHR	8EW 009 160-491 Interior Blower	454
19.242 FK	177 kW		01/88→02/89			
19.242 FS,19.242 FLS,19.242 FLLS	177 kW		01/88→01/89	+ OE 81259070186	9ML 351 332-121 Resistor, interior blower	457
19.262 F,19.262 FL,19.262 FLL	191 kW		01/88→02/90	+ OE 81259070187	9ML 351 332-151 Resistor, interior blower	457
19.262 FK	191 kW		01/88→02/90			
19.262 FS,19.262 FLS,19.262 FLLS	191 kW		01/88→02/90			
19.342 F,19.342 FL,19.342 FLL	250 kW		05/94→05/95			
19.342 FK	250 kW		05/94→05/95			
19.342 FS,19.342 FLS,19.342 FLLS	250 kW		05/94→05/95			
19.372 F,19.372 FL,19.372 FLL	249 kW		05/90→04/95			
19.372 FK	249 kW		05/90→04/95			
19.372 FS,19.372 FLS,19.372 FLLS	249 kW		05/90→04/95			
19.402 F,19.402 FL,19.402 FLL	294 kW		05/94→05/95			
19.402 FK	294 kW		05/94→05/95			
19.402 FS,19.402 FLS,19.402 FLLS	294 kW		05/94→05/95			
19.502 F,19.502 FL,19.502 FLL	368 kW		02/90→06/96			
19.502 FS,19.502 FLS,19.502 FLLS	368 kW		02/90→06/96			
24.242 FNL,24.242 FNLL,24.242 FVL	177 kW		01/88→02/90			
24.262 DFS,24.262 DFLS	191 kW		01/88→02/90			
24.262 FNL,24.262 FNLL,24.262 FVL	191 kW		01/88→02/90			
24.462 FNL	338 kW		04/89→02/90			
24.502 FNL	368 kW		02/90→12/90			
25.502 FNL	368 kW		09/90→12/92			
26.242 DFAK	177 kW		02/89→07/89			
26.262 DFA	191 kW		02/89→02/90			
26.262 DFAK	191 kW		02/89→02/90			
26.262 DFAS	191 kW		02/89→02/90			
26.342 DF,26.342 DFL	250 kW		05/94→06/96			
26.342 DFK,26.342 DFLK	250 kW		05/94→06/96			
26.362 DF, 26.362 DFL	265 kW		09/87→02/90			
26.362 DFA	265 kW		05/88→02/90			
26.362 DFAK	265 kW		05/88→02/90			
26.362 DFAS	265 kW		05/88→02/90			
26.402 DF,26.402 DFL	294 kW		05/94→06/96			
26.402 DFK,26.402 DFLK	294 kW		05/94→06/96			
26.462 DFA	338 kW		08/89→02/90			
26.462 DFAS	338 kW		08/89→02/90			
26.502 DFA	368 kW		02/90→12/92			

Manufacturer - Model	Power	Displ.	Year of Constr.	Remark	Part Number	Page
MAN - F 90					07/86→12/97	
26.502 DFAS	368 kW		02/90→12/92	Mounting Diameter [mm]: 59; Vers. produced by BEHR	8EW 009 160-491	454
26.502 DFS,26.502 DFLS	368 kW		02/90→06/96		Interior Blower	
26.502 FNL,26.502 FNLL	368 kW		09/91→06/96	+ OE 81259070186	9ML 351 332-121	457
32.262 VF	191 kW		02/89→02/90	+ OE 81259070187	Resistor, interior blower	
32.262 VFK	191 kW		02/89→02/90		9ML 351 332-151	457
32.262 VFTM	191 kW		02/89→02/90		Resistor, interior blower	
32.292 VF	213 kW		03/88→02/90			
32.292 VFK	213 kW		03/88→02/90			
32.332 VF	243 kW		03/88→02/90			
32.332 VFK	243 kW		03/88→02/90			
32.342 VFK	250 kW		05/94→06/96			
32.362 VF	265 kW		03/88→02/90			
32.362 VFK	265 kW		03/88→02/90			
32.402 VFK	294 kW		05/94→06/96			
33.262 DFA	191 kW		07/89→02/90			
33.262 DFAK	191 kW		07/89→02/90			
33.292 DF	213 kW		09/87→02/90			
33.292 DFA	213 kW		05/88→02/90			
33.292 DFAK	213 kW		05/88→02/90			
33.292 DFAS	213 kW		05/88→02/90			
33.332 DFA	243 kW		05/88→02/90			
33.332 DFAK	243 kW		05/88→02/90			
33.332 DFAS	243 kW		05/88→02/90			
33.342 DFA	250 kW		05/94→06/96			
33.362 DFA	265 kW		05/88→02/90			
33.362 DFAS	265 kW		05/88→02/90			
33.402 DFA	294 kW		05/94→06/96			
33.402 DFAK	294 kW		05/94→06/96			
33.462 DFA	338 kW		07/89→02/90			
33.502 DFA	368 kW		09/91→06/96			
35.262 VF	191 kW		02/89→02/90			
35.262 VFA	191 kW		07/89→02/90			
35.262 VFK	191 kW		02/89→02/90			
35.292 VF	213 kW		10/88→04/95			
35.292 VFK	213 kW		10/88→04/95			
35.302 VFA	220 kW		05/90→09/91			
35.302 VFAK	220 kW		05/90→09/91			
35.322 VFAK	235 kW		02/90→06/96			
35.332 VFK	243 kW		10/88→04/95			
35.342 VF	250 kW		05/94→06/96			
35.342 VFK	250 kW		05/94→06/96			
35.362 VF	265 kW		10/88→02/90			
35.362 VFK	265 kW		10/88→02/90			
35.402 VF	294 kW		05/94→06/96			
35.402 VFK	294 kW		05/94→06/96			
40.402 DFA	294 kW		05/95→06/96			
40.462 DFA	338 kW		07/89→02/90			
40.502 DFA	368 kW		02/90→06/96			
41.262 VF	191 kW		07/89→02/90			
41.262 VFK	191 kW		07/89→02/90			
41.292 VF	213 kW		10/88→02/90			
41.292 VFK	213 kW		10/88→02/90			
41.332 VF	243 kW		10/88→02/90			
41.332 VFK	243 kW		10/88→02/90			
41.342 VF	250 kW		05/94→06/96			
41.362 VF	265 kW		10/88→02/90			
41.362 VFK	265 kW		10/88→02/90			
41.402 VF	294 kW		05/94→06/96			
19.272 F,19.272 FL,19.272 FLL	198 kW		02/90→05/95	+ OE 0018300208 / + OE A0018300208 / + OE 81619300042 / + OE 8157216; Vers. produced by BEHR	8EW 009 160-021	453
26.332 DFA	243 kW		05/88→02/90		Interior Blower	
33.322 DFA	235 kW		09/91→06/96	Mounting Diameter [mm]: 59; Vers. produced by BEHR	8EW 009 160-491	454
33.372 DFAK	272 kW		01/91→06/96		Interior Blower	
35.372 VFK	272 kW		02/90→06/96	+ OE 81619306064; 24 V; Vers. produced by BEHR	8EW 009 160-791	454
				Vers. produced by BEHR	8FH 351 312-361 Heat Exchanger, interior heating	455
				+ OE 81259070186	9ML 351 332-121	457
					Resistor, interior blower	
				+ OE 81259070187	9ML 351 332-151	457
					Resistor, interior blower	
19.272 FA	198 kW		02/90→05/95	+ OE 8157216 / + OE A0018300208 / + OE 0018300208 / + OE 81619300042; Vers. produced by BEHR	8EW 009 160-021	453
19.272 FAK	198 kW		02/90→05/95		Interior Blower	
19.322 FA	235 kW		02/90→06/96	+ OE 81619306064; 24 V; Vers. produced by BEHR	8EW 009 160-791	454
19.322 FAK	235 kW		02/90→06/96		Interior Blower	
19.322 FAS	235 kW		02/90→06/96	Vers. produced by BEHR	8FH 351 312-361 Heat Exchanger, interior heating	455
19.372 FA	272 kW		02/90→06/96			
19.372 FAK	272 kW		02/90→06/96			
19.372 FAS	272 kW		02/90→06/96			

Manufacturer - Model	Power	Displ.	Year of Constr.	Remark	Part Number	Page
MAN - F 90					07/86→12/97	
19.422 FA	309 kW		02/90→06/96	+ OE 8157216 / + OE A0018300208 / + OE 0018300208 / + OE 81619300042; Vers. produced by BEHR	8EW 009 160-021	453
19.422 FAK	309 kW		02/90→06/96		Interior Blower	
19.422 FAS	309 kW		02/90→06/96	+ OE 81619306064; 24 V; Vers. produced by BEHR	8EW 009 160-791	454
24.272 DF	198 kW		02/90→12/90		Interior Blower	
24.272 DFK	198 kW		02/90→12/90	Vers. produced by BEHR	8FH 351 312-361 Heat Exchanger, interior heating	455
24.292 DF	213 kW		04/87→02/90			
24.292 DFK	213 kW		04/87→02/90			
24.302 DF	220 kW		05/90→12/90			
24.302 DFK	220 kW		05/90→12/90			
24.322 DFK	235 kW		02/90→12/90			
24.332 DF	243 kW		04/87→02/90			
24.332 DFK	243 kW		04/87→02/90			
24.362 DF	265 kW		04/87→02/90			
24.362 DFK	265 kW		04/87→02/90			
25.272 DF	198 kW		09/90→12/92			
25.272 DFK	198 kW		09/90→12/92			
25.302 DF	220 kW		09/90→12/91			
25.302 DFK	220 kW		09/90→12/91			
25.322 DF, 25.322 DFL	235 kW		09/90→12/92			
25.322 DFK	235 kW		09/90→12/92			
25.372 DFK	272 kW		09/90→12/92			
25.422 DF	309 kW		09/90→12/92			
25.422 DFK	309 kW		09/90→12/92			
26.272 DF	198 kW		02/90→06/96			
26.272 DFK	198 kW		02/90→06/96			
26.272 FNL,26.272 FNLL	198 kW		03/91→05/95			
26.272 FNLS,26.272 FVLS	198 kW		09/90→12/95			
26.292 DF, 26.292 DFL	213 kW		09/87→02/90			
26.292 DFK	213 kW		09/87→02/90			
26.302 FNL, 26.302 FNLL, 26.302 FVL	220 kW		03/91→12/91			
26.302 FNLS,26.302 FVLS	220 kW		09/90→12/91			
26.322 DF	235 kW		02/90→06/96			
26.322 DFK	235 kW		02/92→06/96			
26.372 DFK	272 kW		01/92→06/96			
26.372 DFS	272 kW		02/90→06/96			
26.372 FNL,26.372 FNLL,26.372 FVL	272 kW		09/90→12/95			
26.422 FNL,26.422 FNLL,26.422 FVL	309 kW		09/90→12/95			
26.422 FNLS,26.422 FVLS	309 kW		01/92→12/95			
33.272 DF	198 kW		10/92→04/95			
33.292 DFS	213 kW		09/87→02/90			
33.322 DF	235 kW		09/91→06/96			
33.372 DFK	272 kW		01/91→06/96			
33.372 DFS	272 kW		09/91→06/96			
33.422 DF	309 kW		09/91→06/96			
33.422 DFK	309 kW		01/94→06/96			
33.422 DFS	309 kW		01/94→06/96			
40.372 DF	272 kW		12/91→06/96			
19.272 FAS	198 kW		02/90→05/95	+ OE A0018300208 / + OE 0018300208 / + OE 81619300042 / + OE 8157216; Vers. produced by BEHR	8EW 009 160-021	453
24.322 DF	235 kW		02/90→12/90		Interior Blower	
				+ OE 81619306064; 24 V; Vers. produced by BEHR	8EW 009 160-791	454
					Interior Blower	
				Vers. produced by BEHR	8FH 351 312-361 Heat Exchanger, interior heating	455
19.272 FK	198 kW		02/90→05/95	+ OE 8157216 / + OE A0018300208 / + OE 0018300208 / + OE 81619300042; Vers. produced by BEHR	8EW 009 160-021	453
19.272 FS,19.272 FLS,19.272 FLLS	198 kW		02/90→05/95		Interior Blower	
19.322 FK	235 kW		02/90→05/95	Mounting Diameter [mm]: 59; Vers. produced by BEHR	8EW 009 160-491	454
19.322 FS,19.322 FLS,19.322 FLLS	235 kW		02/90→05/95		Interior Blower	
19.372 F,19.372 FL,19.372 FLL	272 kW		02/90→05/95	+ OE 81619306064; 24 V; Vers. produced by BEHR	8EW 009 160-791	454
19.372 FK	272 kW		02/90→05/95		Interior Blower	
19.372 FS,19.372 FLS,19.372 FLLS	272 kW		02/90→05/95	Vers. produced by BEHR	8FH 351 312-361 Heat Exchanger, interior heating	455
19.422 F,19.422 FL,19.422 FLL	309 kW		02/90→05/95	+ OE 81259070186	9ML 351 332-121	457
19.422 FK	309 kW		02/90→05/95		Resistor, interior blower	
19.422 FS,19.422 FLS,19.422 FLLS	309 kW		02/90→05/95	+ OE 81259070187	9ML 351 332-151	457
19.462 F,19.462 FL	338 kW		05/87→02/90		Resistor, interior blower	
19.462 FK	338 kW		05/87→02/90			
19.462 FS,19.462 FLS	338 kW		05/87→02/90			
24.272 DFS,24.272 DFLS	198 kW		02/90→04/95			
24.272 FNL,24.272 FNLL,24.272 FVL	198 kW		02/90→05/95			
24.302 DFS,24.302 DFLS	220 kW		05/90→04/95			
24.302 FNL,24.302 FNLL,24.302 FVL	220 kW		05/90→10/90			

Manufacturer - Model	Power	Displ.	Year of Constr.	Remark	Part Number	Page
MAN - F 90						07/86→12/97
24.322 DFS,24.322 DFLS	235 kW		02/90→12/90	+ OE 8157216 / + OE A0018300208 / + OE 0018300208 / + OE 81619300042; Vers. produced by BEHR	8EW 009 160-021 Interior Blower	453
24.332 DFS,24.332 DFLS	243 kW		04/87→02/90			
24.362 DFS,24.362 DFLS	265 kW		04/87→02/90	Mounting Diameter [mm]: 59; Vers. produced by BEHR	8EW 009 160-491 Interior Blower	454
24.372 FNL,24.372 FNLL,24.372 FVL	272 kW		02/90→05/95			
24.372 FNLS,24.372 FVLS	272 kW		02/90→05/95	+ OE 81619306064; 24 V; Vers. produced by BEHR	8EW 009 160-791 Interior Blower	454
24.422 FNL,24.422 FNLL,24.422 FVL	309 kW		02/90→05/95			
25.272 DFS,25.272 DFLS	198 kW		09/90→12/92	Vers. produced by BEHR	8FH 351 312-361 Heat Exchanger, interior heating	455
25.272 FNL,25.272 FNLL,25.272 FVL	198 kW		09/90→10/93			
25.302 DFS, 25.302 DFLS	220 kW		09/90→12/91	+ OE 81259070186	9ML 351 332-121 Resistor, interior blower	457
25.302 FNL, 25.302 FNLL, 25.302 FVL	220 kW		09/90→12/91			
25.302 FNLS, 25.302 FVLS	220 kW		09/90→12/91	+ OE 81259070187	9ML 351 332-151 Resistor, interior blower	457
25.322 DFS, 25.322 DFLS	235 kW		09/90→12/92			
25.322 FNL, 25.322 FNLL, 25.322 FVL	235 kW		09/90→12/92			
25.322 FNLS,25.322 FVLS	235 kW		09/90→12/92			
25.372 DFS,25.372 DFLS	272 kW		09/90→12/92			
25.372 FNL, 25.372 FNLL, 25.372 FVL	272 kW		09/90→12/92			
25.372 FNLS,25.372 FVLS	272 kW		09/90→10/93			
25.422 DFS,25.422 DFLS	309 kW		09/90→12/92			
25.422 FNL,25.422 FNLL	309 kW		09/90→12/92			
25.422 FNLS,25.422 FVLS	309 kW		09/90→12/92			
26.272 DFA	198 kW		02/90→12/92			
26.272 DFAK	198 kW		02/90→12/92			
26.272 DFAS	198 kW		02/90→12/92			
26.272 DFS,26.272 DFLS	198 kW		02/90→06/96			
26.292 DFAK	213 kW		05/88→02/90			
26.302 DFA	220 kW		05/90→12/91			
26.302 DFAK	220 kW		05/90→12/91			
26.302 DFAS	220 kW		05/90→12/91			
26.322 DFA	235 kW		02/90→12/92			
26.322 DFAK	235 kW		02/90→12/92			
26.322 DFAS	235 kW		02/90→12/92			
26.322 DFS,26.322 DFLS	235 kW		02/90→06/96			
26.332 DFAK	243 kW		05/88→02/90			
26.332 DFAS	243 kW		05/88→02/90			
26.372 DF,26.372 DFL	272 kW		02/90→06/96			
26.372 DFA	272 kW		02/90→12/92			
26.372 DFAK	272 kW		01/92→06/96			
26.372 DFAS	272 kW		02/90→12/92			
26.422 DF,26.422 DFL	309 kW		02/90→06/96			
26.422 DFA	309 kW		02/90→12/92			
26.422 DFAK	309 kW		02/90→12/92			
26.422 DFAS	309 kW		02/90→12/92			
32.302 VF	220 kW		05/90→09/91			
32.302 VFK	220 kW		05/90→09/91			
32.322 VF	235 kW		02/90→06/96			
32.322 VFK	235 kW		02/90→06/96			
32.372 VF	272 kW		02/90→06/96			
32.422 VF	309 kW		02/90→06/96			
33.372 DF	272 kW		09/91→06/96			
33.372 DFA	272 kW		09/91→06/96			
33.422 DFA	309 kW		09/91→06/96			
33.422 DFAK	309 kW		01/94→06/96			
35.272 VF	198 kW		02/90→12/91			
35.272 VFK	198 kW		02/90→12/92			
35.322 VFK	235 kW		02/90→06/96			
35.322 VK	235 kW		02/90→06/96			
35.372 VF	272 kW		02/90→06/96			
35.422 VF	309 kW		02/90→06/96			
35.422 VF	309 kW		02/90→12/97			
35.422 VFK	309 kW		02/90→06/96			
35.422 VFK	309 kW		02/90→12/97			
40.372 DFA	272 kW		12/91→06/96			
40.422 DFA	309 kW		12/91→06/96			
41.272 VF	198 kW		02/90→12/91			
41.322 VF	235 kW		02/90→06/96			
41.372 VF	272 kW		02/90→06/96			
41.422 VF	309 kW		02/90→06/96			
19.292 F,19.292 FL,19.292 FLL	213 kW		07/86→02/90	+ OE 0008309308 / + OE A0008309308 / + OE 81619300036 / + OE 1294099; →08/87; with housing; Rated Power [W]: 216; 24 V; with integrated regulator; Vers. produced by BEHR	8EW 009 158-481 Interior Blower	452
19.292 FK	213 kW		07/86→02/90			
19.292 FS,19.292 FLS,19.292 FLLS	213 kW		07/86→02/90			
19.332 F,19.332 FL,19.332 FLL	243 kW		07/86→02/90	+ OE 8157216 / + OE A0018300208 / + OE 0018300208 / + OE 81619300042; Vers. produced by BEHR	8EW 009 160-021 Interior Blower	453
19.332 FK	243 kW		07/86→02/90			
19.332 FS,19.332 FLS,19.332 FLLS	243 kW		07/86→02/90			

Manufacturer - Model	Power	Displ.	Year of Constr.	Remark	Part Number	Page
MAN - F 90					07/86→12/97	
19.362 F,19.362 FL,19.362 FLL	265 kW		07/86→02/90	Mounting Diameter [mm]: 59; Vers. produced by BEHR	8EW 009 160-491 Interior Blower	454
19.362 FK	265 kW		07/86→02/90			
24.292 FNL,24.292 FNLL,24.292 FVL	213 kW		10/86→02/90	+ OE 81619306064; 24 V; Vers. produced by BEHR	8EW 009 160-791 Interior Blower	454
24.332 FNL,24.332 FNLL,24.332 FVL	243 kW		10/86→02/90	Vers. produced by BEHR	8FH 351 312-361 Heat Exchanger, interior heating	455
24.332 FNLS,24.332 FVLS	243 kW		10/86→02/90			
24.362 FNLS,24.362 FVLS	265 kW		10/86→02/90	+ OE 81259070186	9ML 351 332-121 Resistor, interior blower	457
				+ OE 81259070187	9ML 351 332-151 Resistor, interior blower	457
19.322 F,19.322 FL,19.322 FLL	235 kW		02/90→05/95	+ OE 0008309308 / + OE A0008309308 / + OE 1294099 / + OE 81619300036; with housing; Rated Power [W]: 216; 24 V; with integrated regulator; Vers. produced by BEHR	8EW 009 158-481 Interior Blower	452
				+ OE 8157216 / + OE A0018300208 / + OE 0018300208 / + OE 81619300042; Vers. produced by BEHR	8EW 009 160-021 Interior Blower	453
				Mounting Diameter [mm]: 59; Vers. produced by BEHR	8EW 009 160-491 Interior Blower	454
				+ OE 81619306064; 24 V; Vers. produced by BEHR	8EW 009 160-791 Interior Blower	454
				Vers. produced by BEHR	8FH 351 312-361 Heat Exchanger, interior heating	455
				+ OE 81259070186	9ML 351 332-121 Resistor, interior blower	457
				+ OE 81259070187	9ML 351 332-151 Resistor, interior blower	457
19.362 FS,19.362 FLS,19.362 FLLS	265 kW		07/86→02/90	+ OE A0008309308 / + OE 0008309308 / + OE 81619300036 / + OE 1294099; →08/87; with housing; Rated Power [W]: 216; 24 V; with integrated regulator; Vers. produced by BEHR	8EW 009 158-481 Interior Blower	452
24.362 FNL,24.362 FNLL,24.362 FVL	265 kW		10/86→02/90	+ OE 8157216 / + OE A0018300208 / + OE 0018300208 / + OE 81619300042; Vers. produced by BEHR	8EW 009 160-021 Interior Blower	453
				Mounting Diameter [mm]: 59; Vers. produced by BEHR	8EW 009 160-491 Interior Blower	454
				+ OE 81619306064; 24 V; Vers. produced by BEHR	8EW 009 160-791 Interior Blower	454
				Vers. produced by BEHR	8FH 351 312-361 Heat Exchanger, interior heating	455
				+ OE 81259070186	9ML 351 332-121 Resistor, interior blower	457
				+ OE 81259070187	9ML 351 332-151 Resistor, interior blower	457
24.272 FNLS,24.272 FVLS	198 kW		02/90→05/95	+ OE 8157216 / + OE A0018300208 / + OE 0018300208 / + OE 81619300042; Vers. produced by BEHR	8EW 009 160-021 Interior Blower	453
24.322 FNLS,24.322 FVLS	235 kW		02/90→05/95			
				Mounting Diameter [mm]: 59; Vers. produced by BEHR	8EW 009 160-491 Interior Blower	454
				+ OE 81619306064; 24 V; Vers. produced by BEHR	8EW 009 160-791 Interior Blower	454
				+ OE 81259070186	9ML 351 332-121 Resistor, interior blower	457
				+ OE 81259070187	9ML 351 332-151 Resistor, interior blower	457
24.292 DFS,24.292 DFLS	213 kW		04/87→02/90	+ OE 8157216 / + OE A0018300208 / + OE 81619300042; Vers. produced by BEHR	8EW 009 160-021 Interior Blower	453
26.292 DFAS	213 kW		05/88→02/90			
				Mounting Diameter [mm]: 59; Vers. produced by BEHR	8EW 009 160-491 Interior Blower	454
				+ OE 81619306064; 24 V; Vers. produced by BEHR	8EW 009 160-791 Interior Blower	454
				Vers. produced by BEHR	8FH 351 312-361 Heat Exchanger, interior heating	455
				+ OE 81259070186	9ML 351 332-121 Resistor, interior blower	457
				+ OE 81259070187	9ML 351 332-151 Resistor, interior blower	457
24.292 FNLS,24.292 FVLS	213 kW		10/86→02/90	+ OE 81619300036 / + OE 1294099; →08/87; with housing; Rated Power [W]: 216; 24 V; with integrated regulator; Vers. produced by BEHR	8EW 009 158-481 Interior Blower	452
				+ OE 8157216 / + OE A0018300208 / + OE 0018300208 / + OE 81619300042; Vers. produced by BEHR	8EW 009 160-021 Interior Blower	453

Manufacturer - Model	Power	Displ.	Year of Constr.	Remark	Part Number	Page
MAN - F 90					07/86→12/97	
24.292 FNLS,24.292 FVLS	213 kW		10/86→02/90	Mounting Diameter [mm]: 59; Vers. produced by BEHR	8EW 009 160-491 Interior Blower	454
				+ OE 81619306064; 24 V; Vers. produced by BEHR	8EW 009 160-791 Interior Blower	454
				Vers. produced by BEHR	8FH 351 312-361 Heat Exchanger, interior heating	455
				+ OE 81259070186	9ML 351 332-121 Resistor, interior blower	457
				+ OE 81259070187	9ML 351 332-151 Resistor, interior blower	457
24.322 FNL,24.322 FNLL,24.322 FVL	235 kW		02/90→05/95	+ OE 8157216 / + OE 81619300042; Vers. produced by BEHR	8EW 009 160-021 Interior Blower	453
				Mounting Diameter [mm]: 59; Vers. produced by BEHR	8EW 009 160-491 Interior Blower	454
				+ OE 81619306064; 24 V; Vers. produced by BEHR	8EW 009 160-791 Interior Blower	454
				Vers. produced by BEHR	8FH 351 312-361 Heat Exchanger, interior heating	455
				+ OE 81259070186	9ML 351 332-121 Resistor, interior blower	457
24.372 DF 24.372 DFK 24.372 DFK 24.372 DFS 24.422 DFK 25.372 DF 25.372 DFK 25.372 DFS	249 kW 249 kW 272 kW 249 kW 309 kW 249 kW 249 kW 249 kW		05/90→12/90 05/90→12/90 02/90→12/90 05/90→12/90 02/90→12/90 09/90→12/92 09/90→12/92 09/90→12/92	Vers. produced by BEHR	8FH 351 312-361 Heat Exchanger, interior heating	455
				Mounting Diameter [mm]: 59; Vers. produced by BEHR	8EW 009 160-491 Interior Blower	454
				Vers. produced by BEHR	8FH 351 312-361 Heat Exchanger, interior heating	455
				+ OE 81259070186	9ML 351 332-121 Resistor, interior blower	457
				+ OE 81259070187	9ML 351 332-151 Resistor, interior blower	457
				Mounting Diameter [mm]: 59; Vers. produced by BEHR	8EW 009 160-491 Interior Blower	454
				Vers. produced by BEHR	8FH 351 312-361 Heat Exchanger, interior heating	455
24.372 DF 24.372 DFS, 24.372 DFLS 24.422 DFS,24.422 DFLS 32.272 VF 32.272 VFK 32.372 VF 32.372 VFK 32.372 VFK 35.332 VF 35.372 VF 35.372 VFK	272 kW 272 kW 309 kW 198 kW 198 kW 249 kW 249 kW 272 kW 243 kW 249 kW 249 kW		02/90→12/90 02/90→04/95 02/90→12/90 02/90→04/95 02/90→04/95 02/90→06/96 05/90→04/95 02/90→06/96 10/88→04/95 02/90→04/95 02/90→04/95	Mounting Diameter [mm]: 59; Vers. produced by BEHR	8EW 009 160-491 Interior Blower	454
				Vers. produced by BEHR	8FH 351 312-361 Heat Exchanger, interior heating	455
				+ OE 81259070186	9ML 351 332-121 Resistor, interior blower	457
				+ OE 81259070187	9ML 351 332-151 Resistor, interior blower	457
				Mounting Diameter [mm]: 59; Vers. produced by BEHR	8EW 009 160-491 Interior Blower	454
				Vers. produced by BEHR	8FH 351 312-361 Heat Exchanger, interior heating	455
				+ OE 81259070186	9ML 351 332-121 Resistor, interior blower	457
				+ OE 81259070187	9ML 351 332-151 Resistor, interior blower	457
				Mounting Diameter [mm]: 59; Vers. produced by BEHR	8EW 009 160-491 Interior Blower	454
				Vers. produced by BEHR	8FH 351 312-361 Heat Exchanger, interior heating	455
25.372 DF 26.322 FNLS,26.322 FVLS 26.372 FNLS,26.372 FVLS 26.422 DFS 40.422 DF	272 kW 235 kW 272 kW 309 kW 309 kW		09/90→12/92 09/90→12/95 01/92→06/96 02/90→12/95 12/91→06/96	+ OE 0018300208 / + OE A0018300208 / + OE 81619300042 / + OE 8157216; Vers. produced by BEHR	8EW 009 160-021 Interior Blower	453
				+ OE 81619306064; 24 V; Vers. produced by BEHR	8EW 009 160-791 Interior Blower	454
				Vers. produced by BEHR	8FH 351 312-361 Heat Exchanger, interior heating	455
				Mounting Diameter [mm]: 59; Vers. produced by BEHR	8EW 009 160-491 Interior Blower	454
				Vers. produced by BEHR	8FH 351 312-361 Heat Exchanger, interior heating	455
26.292 DFA 33.272 DFA	213 kW 198 kW		05/88→02/90 10/92→04/95	+ OE A0018300208 / + OE 0018300208 / + OE 81619300042 / + OE 8157216; Vers. produced by BEHR	8EW 009 160-021 Interior Blower	453
				Mounting Diameter [mm]: 59; Vers. produced by BEHR	8EW 009 160-491 Interior Blower	454
				+ OE 81619306064; 24 V; Vers. produced by BEHR	8EW 009 160-791 Interior Blower	454
				Vers. produced by BEHR	8FH 351 312-361 Heat Exchanger, interior heating	455
				+ OE 81259070186	9ML 351 332-121 Resistor, interior blower	457
				+ OE 81259070187	9ML 351 332-151 Resistor, interior blower	457
26.292 DFS	213 kW		09/87→02/90	+ OE 8157216 / + OE A0018300208 / + OE 0018300208; Vers. produced by BEHR	8EW 009 160-021 Interior Blower	453
				+ OE 81619306064; 24 V; Vers. produced by BEHR	8EW 009 160-791 Interior Blower	454
				Vers. produced by BEHR	8FH 351 312-361 Heat Exchanger, interior heating	455

Manufacturer - Model	Power	Displ.	Year of Constr.	Remark	Part Number	Page
MAN - F 90					07/86→12/97	
26.322 FNL, 26.322 FNLL	235 kW		03/91→05/95	+ OE 81619300042 / + OE 0018300208 / + OE A0018300208 / + OE 8157216; Vers. produced by BEHR	8EW 009 160-021 Interior Blower	453
				+ OE 81619306064; 24 V; Vers. produced by BEHR	8EW 009 160-791 Interior Blower	454
				Vers. produced by BEHR	8FH 351 312-361 Heat Exchanger, interior heating	455
26.332 DF, 26.332 DFL	243 kW		09/87→02/90	+ OE 0018300208 / + OE A0018300208 / + OE 81619300042 / + OE 8157216; Vers. produced by BEHR	8EW 009 160-021 Interior Blower	453
				+ OE 81619306064; 24 V; Vers. produced by BEHR	8EW 009 160-791 Interior Blower	454
				Vers. produced by BEHR	8FH 351 312-361 Heat Exchanger, interior heating	455
26.422 DFK	309 kW		02/90→12/95	+ OE 8157216 / + OE A0018300208 / + OE 81619300042; Vers. produced by BEHR	8EW 009 160-021 Interior Blower	453
				+ OE 81619306064; 24 V; Vers. produced by BEHR	8EW 009 160-791 Interior Blower	454
				Vers. produced by BEHR	8FH 351 312-361 Heat Exchanger, interior heating	455
33.292 DFK	213 kW		09/87→02/90	+ OE 8157216 / + OE 0018300208 / + OE 81619300042; Vers. produced by BEHR	8EW 009 160-021 Interior Blower	453
				+ OE 81619306064; 24 V; Vers. produced by BEHR	8EW 009 160-791 Interior Blower	454
				Vers. produced by BEHR	8FH 351 312-361 Heat Exchanger, interior heating	455
35.302 VF	220 kW		05/90→09/91	+ OE 0018300208 / + OE A0018300208 / + OE 81619300042 / + OE 8157216; Vers. produced by BEHR	8EW 009 160-021 Interior Blower	453
				+ OE 8157216 / + OE A0018300208 / + OE 0018300208 / + OE 81619300042; Vers. produced by BEHR	8EW 009 160-021 Interior Blower	453
				Mounting Diameter [mm]: 59; Vers. produced by BEHR	8EW 009 160-491 Interior Blower	454
				+ OE 81619306064; 24 V; Vers. produced by BEHR	8EW 009 160-791 Interior Blower	454
				Vers. produced by BEHR	8FH 351 312-361 Heat Exchanger, interior heating	455
				+ OE 81259070186	9ML 351 332-121 Resistor, interior blower	457
				+ OE 81259070187	9ML 351 332-151 Resistor, interior blower	457
35.302 VFK	220 kW		05/90→09/91	+ OE 8157216 / + OE A0018300208 / + OE 0018300208 / + OE 81619300042; Vers. produced by BEHR	8EW 009 160-021 Interior Blower	453
				+ OE 8157216 / + OE 81619300042; Vers. produced by BEHR	8EW 009 160-021 Interior Blower	453
				Mounting Diameter [mm]: 59; Vers. produced by BEHR	8EW 009 160-491 Interior Blower	454
				+ OE 81619306064; 24 V; Vers. produced by BEHR	8EW 009 160-791 Interior Blower	454
				Vers. produced by BEHR	8FH 351 312-361 Heat Exchanger, interior heating	455
				+ OE 81259070186	9ML 351 332-121 Resistor, interior blower	457
				+ OE 81259070187	9ML 351 332-151 Resistor, interior blower	457
MAN - F 2000					01/94→	
19.293 FAC	213 kW		01/94→	Depth [mm]: 42; L 370 mm; for vehicles without air conditioning; Vers. produced by BEHR; W 189 mm	8FH 351 312-441 Heat Exchanger, interior heating	456
19.293 FAK	213 kW		01/94→			
19.293 FAS	213 kW		01/94→			
19.293 FC, 19.293 FLC, 19.293 FLLC	213 kW		01/94→			
19.293 FS, 19.293 FLS, 19.293 FLLS	213 kW		01/94→			
19.323 FAC	235 kW		01/94→12/95			
19.323 FAK	235 kW		01/94→12/95			
19.323 FAS	235 kW		01/94→12/95			
19.323 FC, 19.323 FLC, 19.323 FLLC	235 kW		01/94→12/95			
19.323 FS, 19.323 FLS, 19.323 FLLS	235 kW		01/94→12/95			
19.343 FAC	250 kW		01/94→			
19.343 FAK	250 kW		01/94→			

Manufacturer - Model	Power	Displ.	Year of Constr.	Remark	Part Number	Page
MAN - F 2000						01/94→
19.343 FAS	250 kW		01/94→	Depth [mm]: 42; L 370 mm; for vehicles with/ without air conditioning; Vers. produced by BEHR; W 189 mm	8FH 351 312-441 Heat Exchanger, interior heating	456
19.343 FC,19.343 FLC,19.343 FLLC	250 kW		01/94→			
19.343 FK,19.343 FLK	250 kW		01/94→			
19.343 FS,19.343 FLS,19.343 FLLS	250 kW		01/94→			
19.403 FAC	294 kW		01/94→			
19.403 FAK, FA-KI	294 kW		01/94→			
19.403 FAS	294 kW		01/94→			
19.403 FC, FLC, FLLC, FRC, FLRC, F-NL	294 kW		01/94→			
19.403 FK, FLK, F-KI, FL-KI	294 kW		01/94→			
19.403 FS, FLS, FLLS, FRS, FLRS, FLLRS	294 kW		01/94→			
19.463 FAC	338 kW		01/94→			
19.463 FAK, FA-KI	338 kW		01/94→			
19.463 FAS	338 kW		01/94→			
19.463 FC, FLC, FLLC, FRC, FLRC, F-NL	338 kW		01/94→			
19.463 FK, FLK, F-KI, FL-KI	338 kW		01/94→			
19.463 FS, FLS, FLLS, FRS, FLRS, FLLRS	338 kW		01/94→			
19.464 FAC	338 kW		06/98→			
19.603 FLS, 19604 FLS	441 kW		04/96→			
23.293 FNLLC	213 kW		01/94→			
23.343 FNLLC	250 kW		01/94→			
23.403 FNLLC	294 kW		01/94→			
23.463 FNLLC	338 kW		01/94→			
23.464 FNLLC	338 kW		05/01→			
24.293 FNLLC	213 kW		01/94→			
24.323 FNLLC	235 kW		01/94→12/95			
24.343 FNLLC	250 kW		01/94→			
24.403 FNLLC	294 kW		01/94→			
24.463 FNLLC	338 kW		01/94→			
24.464 FNLLRC	338 kW		05/01→			
26.293 DFC,26.293 DFCL	213 kW		01/94→			
26.293 DFK,26.293 DFLK	213 kW		01/94→			
26.293 DFS,26.293 DFSL	213 kW		01/94→			
26.293 FNLC,26.293 FNLLC, 26.293 FVLC	213 kW		01/94→			
26.293 FNLS,26.293 FVLS	213 kW		01/94→			
26.323 DFC,26.323 DFCL	235 kW		01/94→12/95			
26.323 DFK,26.323 DFLK	235 kW		01/94→12/95			
26.323 DFS,26.323 DFSL	235 kW		01/94→12/95			
26.323 FNLC,26.323 FNLLC, 26.323 FVLC	235 kW		01/94→12/95			
26.323 FNLS,26.323 FVLS	235 kW		01/94→12/95			
26.343 DFC,26.343 DFCL	250 kW		01/94→			
26.343 DFK,26.343 DFLK	250 kW		01/94→			
26.343 DFS,26.343 DFSL	250 kW		01/94→			
26.343 FNLC,26.343 FNLLC, 26.343 FVLC	250 kW		01/94→			
26.343 FNLS,26.343 FVLS	250 kW		01/94→			
26.403 DFC,26.403 DFCL	294 kW		01/94→			
26.403 DFK,26.403 DFLK	294 kW		01/94→			
26.403 DFS,26.403 DFSL	294 kW		01/94→			
26.403 FNLC,26.403 FNLLC, 26.403 FVLC	294 kW		01/94→			
26.403 FNLS,26.403 FVLS	294 kW		01/94→			
26.463 DFC, DFCL	338 kW		01/94→			
26.463 DFK,26.463 DFLK	338 kW		01/94→			
26.463 DFS,26.463 DFSL	338 kW		01/94→			
26.463 FNLC, FNLLC, FVLC	338 kW		01/94→			
26.463 FNLS,26.463 FVLS	338 kW		01/94→			
26.464 DFC, DFCL	338 kW		05/01→			
26.464 DFK, DFLK	338 kW		05/01→			
26.464 DFS, DFSL	338 kW		05/01→			
26.464 DF-TM	338 kW		05/01→			
26.464 FNLC, FNLLC, FNLLW, FVLC	338 kW		05/01→			
26.464 FNLS	338 kW		05/01→			
26.464 FVL-KO	338 kW		05/01→			
26.464 FVLS, FVLSRS	338 kW		05/01→			
26.603 DFC, DFCL	441 kW		06/96→			
26.603 DFK, DFLK	441 kW		06/96→			
26.603 DFS, DFSL	441 kW		06/96→			
26.604 DFSL	441 kW		04/00→			
27.293 DFAC	213 kW		01/94→			
27.293 DFAK	213 kW		01/94→			
27.293 DFAS	213 kW		01/94→			
27.293 DFC	213 kW		01/94→			

Manufacturer - Model	Power	Displ.	Year of Constr.	Remark	Part Number	Page
MAN - F 2000						01/94→
27.293 DFK	213 kW		01/94→	Depth [mm]: 42; L 370 mm; for vehicles with/ without air conditioning; Vers. produced by BEHR; W 189 mm	8FH 351 312-441 Heat Exchanger, interior heating	456
27.293 DFS	213 kW		01/94→			
27.323 DFAC	235 kW		01/94→12/95			
27.323 DFAK, DFA-KI	235 kW		01/94→			
27.323 DFAS	235 kW		01/94→12/95			
27.323 DFC	235 kW		01/94→12/95			
27.323 DFK, DF-KI	235 kW		01/94→			
27.323 DFS	235 kW		01/94→12/95			
27.343 DFAC	250 kW		01/94→			
27.343 DFAK	250 kW		01/94→			
27.343 DFAS	250 kW		01/94→			
27.343 DFC	250 kW		01/94→			
27.343 DFK	250 kW		01/94→			
27.343 DFS	250 kW		01/94→			
27.403 DFAC	294 kW		01/94→			
27.403 DFAK, DFA-KI	294 kW		01/94→			
27.403 DFAS	294 kW		01/94→			
27.403 DFC	294 kW		01/94→			
27.403 DFK, DF-KI	294 kW		01/94→			
27.403 DFS	294 kW		01/94→			
27.403 DF-TM	294 kW		07/00→			
27.423 DFAC	309 kW		01/94→			
27.463 DFAC	338 kW		01/94→			
27.463 DFAK, DFA-KI	338 kW		01/94→			
27.463 DFAS	338 kW		01/94→			
27.463 DFC	338 kW		01/94→			
27.463 DFK, DF-KI	338 kW		01/94→			
27.463 DFS	338 kW		01/94→			
27.463 DF-TM	338 kW		07/00→			
27.464 DFAC	338 kW		05/01→			
27.464 DFAK, DFA-KI	338 kW		05/01→			
27.464 DFAS	338 kW		05/01→			
27.464 DFC	338 kW		01/94→			
27.464 DFK, DF-KI	338 kW		05/01→			
27.464 DFS	338 kW		01/94→			
27.464 DF-TM	338 kW		05/01→			
27.603 DFAS	441 kW		01/96→			
27.603 DFS	441 kW		01/96→			
32.293 VFC	213 kW		08/95→			
32.343 VFC	250 kW		08/95→			
32.343 VFK	250 kW		08/95→			
32.403 VFC	294 kW		08/95→			
32.403 VFK	294 kW		08/95→			
32.463 VFC	338 kW		08/95→			
32.463 VFK	338 kW		08/95→			
32.464 VF, VFC	338 kW		05/01→			
32.464 VFK, VF-HK	338 kW		05/01→			
32.464 VF-TM	338 kW		05/01→			
33.343 DFAC	250 kW		01/94→			
33.343 DFAK	250 kW		01/94→			
33.343 DFAS	250 kW		01/94→			
33.343 DFC	250 kW		01/94→			
33.343 DFK	250 kW		01/94→			
33.343 DFS	250 kW		01/94→			
33.403 DFAC	294 kW		01/94→			
33.403 DFAK, DFA-KI	294 kW		01/94→			
33.403 DFAS	294 kW		01/94→			
33.403 DFC	294 kW		01/94→			
33.403 DFK, DF-KI	294 kW		01/94→			
33.403 DFS, DFRS	294 kW		01/94→			
33.463 DFAC	338 kW		01/94→			
33.463 DFAK, DFA-KI	338 kW		01/94→			
33.463 DFAS	338 kW		01/94→			
33.463 DFC	338 kW		01/94→			
33.463 DFK, DF-KI	338 kW		01/94→			
33.463 DFS, DFRS	338 kW		01/94→			
33.464 DFAC	338 kW		05/01→			
33.464 DFAK, DFA-KI	338 kW		05/01→			
33.464 DFAS	338 kW		05/01→			
33.464 DFC	338 kW		05/01→			
33.464 DFK, DF-KI	338 kW		05/01→			
33.464 DFS, DFRS	338 kW		05/01→			
33.603 DFAC	441 kW		06/96→			
33.603 DFAS	441 kW		06/96→			
33.603 DFC	441 kW		06/96→			
33.603 DFS	441 kW		06/96→			
35.343 VFC	250 kW		08/95→			
35.343 VFK	250 kW		08/95→			
35.403 VF, VFC, VFRC	294 kW		08/95→			
35.403 VFK, VF-HK, VF-KI	294 kW		03/02→			
35.463 VF, VFC, VFRC	338 kW		08/95→			

Manufacturer - Model	Power	Displ.	Year of Constr.	Remark	Part Number	Page			
MAN - F 2000						01/94→			
35.463 VFK, VF-HK, VF-KI	338 kW		08/95→	Depth [mm]: 42; L 370 mm; for vehicles with/without air conditioning; Vers. produced by BEHR; W 189 mm	8FH 351 312-441 Heat Exchanger, interior heating	456			
35.464 VF, VFC, VFRC	338 kW		05/01→						
35.464 VFK, VF-HK, VF-KI	338 kW		03/02→						
35.464 VF-TM	338 kW		03/02→						
40.403 DFAK	294 kW		01/94→						
40.403 DFK	294 kW		01/94→						
41.343 VFC	250 kW		08/95→						
41.343 VFK	250 kW		08/95→						
41.403 VF, VFC, VFRC	294 kW		08/95→						
41.403 VFK, VF-HK, VF-KI	294 kW		08/95→						
41.463 VF, VFC, VFRC	338 kW		08/95→						
41.463 VFK, VF-HK, VF-KI	338 kW		08/95→						
41.464 VF, VFC, VFRC	338 kW		06/98→						
41.464 VFK, VF-HK, VF-KI	338 kW		03/02→						
MAN - G 90							09/87→05/95		
10.150 F,10.150 FL	92 kW		05/90→10/93				Depth [mm]: 40; L 189 mm; for vehicles with/without air conditioning; Vers. produced by BEHR; W 302 mm	8FH 351 312-241 Heat Exchanger, interior heating	455
10.150 F,10.150 FL	110 - 114 kW		09/87→10/93						
10.150 FK	110 - 114 kW		09/87→10/93						
6.100 F	75 kW		09/87→10/93						
6.100 FK	75 kW		09/87→10/93						
8.100 F	75 kW		09/87→10/93						
8.100 FK	75 kW		09/87→10/93						
8.150 F,8.150 FL	92 kW		05/90→10/93						
8.150 F,8.150 FL	110 - 114 kW		09/87→10/93						
8.150 FAE	110 - 114 kW		05/88→05/95						
8.150 FK	110 - 114 kW		09/87→10/93						
8.150 FS,8.150 FLS	110 - 114 kW		09/87→10/93						
9.150 F,9.150 FL	92 kW		05/90→10/93						
9.150 F,9.150 FL	110 - 114 kW		09/87→10/93						
9.150 FAE	110 - 114 kW		05/88→05/92						
9.150 FK	110 - 114 kW		09/87→10/93						
9.150 FS,9.150 FLS	110 - 114 kW		09/87→10/93						
MAN - G						10/79→08/88			
6.90 F	66 - 66 kW		10/79→09/87	Depth [mm]: 40; L 189 mm; for vehicles with/without air conditioning; Vers. produced by BEHR; W 302 mm	8FH 351 312-241 Heat Exchanger, interior heating	455			
6.90 FK	66 kW		10/79→09/87						
8.136 F,8.136 FL	100 kW		10/79→09/87						
8.136 FAE	100 kW		12/83→08/88						
8.136 FK	100 kW		10/79→08/88						
8.136 FOC	100 kW		03/82→07/88						
8.90 F	66 kW		10/79→09/87						
8.90 FK	66 kW		10/79→09/87						
9.136 F,9.136 FL	100 kW		10/79→09/87						
9.136 FAE	100 kW		12/83→08/88						
9.136 FK	100 kW		10/79→08/88						
9.136 FOC	100 kW		03/82→07/88						
MAN - L 2000							10/93→		
10.145 LC,10.145 LLC, LRC, LLRC (LE140C)	103 kW		09/00→				Depth [mm]: 42; L 370 mm; for vehicles with/without air conditioning; Vers. produced by BEHR; W 189 mm	8FH 351 312-421 Heat Exchanger, interior heating	455
10.145 LK, LRK, L-KI, LR-KI (LE140C)	103 kW		09/00→						
10.145 LLS, LLRS (LE140C)	103 kW		09/00→						
10.163 LC,10.163 LLC, LRC, LLRC (LE160C)	114 kW		09/00→						
10.185 LAC, LAEC, LARC, LAERC, LA-LA, LAE-LF (LE180C)	132 kW		09/00→						
10.185 LAK, LAEK, LARK, LAERK (LE180C)	132 kW		09/00→						
10.185 LC,10.185 LLC, LRC, LLRC (LE180C)	132 kW		09/00→						
10.185 LK, LRK, L-KI, LR-KI (LE180C)	132 kW		09/00→						
10.185 LLS, LLRS (LE180C)	132 kW		09/00→						
10.225 LAC, LAEC, LARC, LAERC, LA-LF, LAE-LF (LE220C)	162 kW		09/00→						
10.225 LAK, LAEK, LARK, LAERK (LE220C)	162 kW		09/00→						
10.225 LC, 10.225 LLC, LRC, LLRC (LE220C)	162 kW		09/00→						
10.225 LK, LRK, L-KI, LR-KI(LE220C)	162 kW		09/00→						
12.185 LC, LLC (LE180C)	132 kW		09/99→						
12.225 LC, LLC (LE220C)	162 kW		09/99→						
8.113 LC,8.113 LLC, LRC, LLRC, (LE110C)	83 kW		09/00→						

Manufacturer - Model	Power	Displ.	Year of Constr.	Remark	Part Number	Page			
MAN - L 2000						10/93→			
8.145 LC,8.145 LLC, L-LF (LE140C)	103 kW		09/00→	Depth [mm]: 42; L 370 mm; for vehicles with/without air conditioning; Vers. produced by BEHR; W 189 mm	8FH 351 312-421 Heat Exchanger, interior heating	455			
8.145 LRK, L-KI, LR-KILK (LE140C)	103 kW		09/00→						
8.163 LC, 8.163 LLC (LE160C)	114 kW		09/00→						
8.185 LAC, LAEC, LARC, LAERC, LA-LF, LAE-LF (LE180C)	132 kW		09/00→						
8.185 LAK, LAEK, LARK, LAERK (LE180C)	132 kW		09/00→						
8.185 LC,8.185 LLC, LRC, LLRC, L-LF (LE180C)	132 kW		09/00→						
8.185 LK, LRK, L-KI, LR-KI (LE180C)	132 kW		09/00→						
8.225 LAC, LAEC, LARC, LAERC (LE220C)	162 kW		09/00→						
8.225 LAK, LAEK, LARK, LAERK (LE220C)	162 kW		09/00→						
8.225 LC,8.225 LLC, LRC, LLRC (LE220C)	162 kW		09/00→						
8.225 LK, LRK, L-KI, LR-KI (LE220C)	162 kW		09/00→						
8.225 LLS, LLRS (LE220C)	162 kW		09/00→						
9.145 LC,9.145 LLC, LRC, LLRC (LE140C)	103 kW		09/00→						
9.145 LK, LRK, L-KI, LR-KI (LE140C)	103 kW		09/00→						
9.185 LC,9.185 LLC, LRC, LLRC (LE180C)	132 kW		09/00→						
9.185 LK, LRK, L-KI, LR-KI (LE180C)	132 kW		09/00→						
9.225 LC,9.225 LLC, LRC, LLRC (LE220C)	162 kW		09/00→						
9.225 LLS, LLRS (LE220C)	162 kW		09/00→						
10.150 FOC	114 - 118 kW		02/95→01/96					9ML 351 029-111 Resistor, interior blower	457
10.225 LC, 10.225 LLC, LRC, LLRC	162 kW		09/00→						
10.225 LLS, LLRS (LE220C)	162 kW		09/00→						
8.145 LLS, LLRS (LE140C)	103 kW		09/00→						
8.185 LLS, LLRS (LE180C)	132 kW		09/00→						
9.145 LLS, LLRS (LE140C)	103 kW		09/00→						
9.185 LLS, LLRS (LE 180C)	132 kW		09/00→						
10.153 LAEK	114 kW		10/93→06/96	+ OE 8157216 / + OE 0018300208 / + OE A0018300208 / + OE 81619300042; Vers. produced by BEHR	8EW 009 160-021 Interior Blower	453			
10.153 LC,10.153 LLC	114 kW		10/93→06/96						
10.153 LK	114 kW		10/93→06/96	+ OE 816193006064; 24 V; Vers. produced by BEHR	8EW 009 160-791 Interior Blower	454			
10.153 LLS	114 kW		10/93→06/96						
10.155 LK, LRK	114 kW		02/04→	Depth [mm]: 42; L 370 mm; for vehicles with/without air conditioning; Vers. produced by BEHR; W 189 mm	8FH 351 312-421 Heat Exchanger, interior heating	455			
10.163 LAC, LAEC, LARC, LAERC	114 - 118 kW		05/94→						
10.163 LAK, LAEK, LARK, LAERK	114 - 118 kW		01/95→		9ML 351 029-111 Resistor, interior blower	457			
10.163 LC,10.163 LLC	114 - 118 kW		05/94→						
10.163 LK, LRK, L-KI, LR-KI	114 - 118 kW		05/94→						
10.163 LLS, LLRS	114 - 118 kW		05/94→						
10.223 LAEC	162 kW		01/95→06/96						
10.223 LC,10.223 LLC	162 - 169 kW		10/93→06/96						
10.223 LK	162 - 169 kW		10/93→06/96						
10.224 LAC, LAEC, LARC, LAERC	162 kW		01/95→						
10.224 LAK, LAEK, LARK, LAERK	162 kW		01/95→						
10.224 LC,10.224 LLC, LRC, LLRC	162 kW		05/94→						
10.224 LK, LRK, L-KI, LR-KI	162 kW		05/94→						
8.103 LC, 8.103 LLC	75 kW		10/93→06/96						
8.103 LK	75 kW		10/93→06/96						
8.113 LC, 8.113 LLC	81 kW		08/95→						
8.113 LK, LRK, L-KI, LR-KI	81 kW		08/95→						
8.145, LA-LF LAE-LF	103 kW		07/00→						
8.153 LAEC	114 kW		01/95→06/96						
8.153 LAEK	114 kW		01/95→09/96						
8.153 LC,8.153 LLC	114 kW		10/93→07/97						
8.155 L, LR, LC, LLC, LRC, LLRC, L-LF	114 kW		02/04→						
8.155 LK, LRK	114 kW		02/04→						
8.155 LLS, LLRS	114 kW		02/04→						
8.163 LAC, LAEC, LARC, LAERC, LA-LF, LAE-LF	114 - 118 kW		01/95→						
8.163 LAEC	104 kW		08/95→03/97						
8.163 LAK, LARK, LAEK, LAERK	104 kW		04/00→						
8.163 LC,8.163 LLC	114 - 118 kW		05/94→						

Manufacturer - Model	Power	Displ.	Year of Constr.	Remark	Part Number	Page
MAN - L 2000						10/93→
8.163 LC,8.163 LLC, LRC, LLRC, L-LF	104 kW		08/95→	+ OE 8157216 / + OE 0018300208 / + OE A0018300208 / + OE 81619300042; Vers. produced by BEHR	8EW 009 160-021 Interior Blower	453
8.163 LK, LRK, L-KI, LR-KI	114 - 118 kW		05/94→			
8.223 LAEC	162 kW		01/95→06/96	+ OE 81619306064; 24 V; Vers. produced by BEHR	8EW 009 160-791 Interior Blower	454
8.223 LC,8.223 LLC	162 - 169 kW		10/93→06/96			
8.223 LK	162 - 169 kW		10/93→06/96	Depth [mm]: 42; L 370 mm; for vehicles with/without air conditioning; Vers. produced by BEHR; W 189 mm	8FH 351 312-421 Heat Exchanger, interior heating	455
8.223 LLS	162 - 169 kW		10/93→06/96			
8.224 LAC, LAEC, LARC, LAERC	162 kW		01/95→			
8.224 LAK, LAEK, LARK, LAERK	162 kW		01/95→			
8.224 LC,8.224 LLC, LRC, LLRC	162 kW		05/94→		9ML 351 029-111 Resistor, interior blower	457
8.224 LK, LRK, L-KI, LR-KI	162 kW		05/94→			
8.224 LLS, LLRS	162 kW		05/94→			
9.153 LC,9.153 LLC	114 kW		10/93→06/96			
9.153 LK	114 kW		10/93→06/96			
9.155 L, LC, LLC, LRC, LLRC	114 kW		02/04→			
9.155 LK, LRK	114 kW		02/04→			
9.155 LLS, LLRS	114 kW		02/04→			
9.163 LC	104 kW		08/95→03/97			
9.163 LK	104 kW		08/95→03/97			
9.163 LK, LRK, L-KI, LR-KI	114 - 118 kW		05/94→			
9.223 LC,9.223 LLC	162 - 169 kW		10/93→06/96			
9.223 LK	162 - 169 kW		10/93→06/96			
9.224 LC,9.224 LLC, LRC, LLRC	162 kW		05/94→			
9.224 LK, LRK, L-KI, LR-KI	162 kW		05/94→			
10.220 FOC,10.220 FOCL	162 kW		02/95→	+ OE 8157216 / + OE 0018300208 / + OE A0018300208 / + OE 81619300042; Vers. produced by BEHR	8EW 009 160-021 Interior Blower	453
10.223 LLS	162 - 169 kW		10/93→06/96			
10.224 LLS, LLRS	162 kW		05/94→			
8.150 FOC,8.150 FOCL	114 - 118 kW		02/95→	+ OE 81619306064; 24 V; Vers. produced by BEHR	8EW 009 160-791 Interior Blower	454
8.153 LLS	114 kW		10/93→06/96			
8.220 FOC,8.220 FOCL	162 kW		04/95→			
9.153 LLS	114 kW		10/93→12/95		9ML 351 029-111 Resistor, interior blower	457
9.163 LLS, LLRS	114 - 118 kW		05/94→			
8.153 LK	114 kW		10/93→07/97	+ OE A0018300208 / + OE 0018300208 / + OE 81619300042 / + OE 8157216; Vers. produced by BEHR	8EW 009 160-021 Interior Blower	453
				+ OE 81619306064; 24 V; Vers. produced by BEHR	8EW 009 160-791 Interior Blower	454
				Depth [mm]: 42; L 370 mm; for vehicles with/without air conditioning; Vers. produced by BEHR; W 189 mm	8FH 351 312-421 Heat Exchanger, interior heating	455
					9ML 351 029-111 Resistor, interior blower	457
8.163 LLS, LLRS	114 - 118 kW		05/94→	+ OE 0018300208 / + OE A0018300208 / + OE 81619300042 / + OE 8157216; Vers. produced by BEHR	8EW 009 160-021 Interior Blower	453
				+ OE 81619306064; 24 V; Vers. produced by BEHR	8EW 009 160-791 Interior Blower	454
					9ML 351 029-111 Resistor, interior blower	457
9.163 LC,9.163 LLC, LRC, LLRC	114 - 118 kW		05/94→	+ OE 0018300208 / + OE A0018300208 / + OE 81619300042; Vers. produced by BEHR	8EW 009 160-021 Interior Blower	453
				+ OE 81619306064; 24 V; Vers. produced by BEHR	8EW 009 160-791 Interior Blower	454
				Depth [mm]: 42; L 370 mm; for vehicles with/without air conditioning; Vers. produced by BEHR; W 189 mm	8FH 351 312-421 Heat Exchanger, interior heating	455
					9ML 351 029-111 Resistor, interior blower	457
9.223 LLS	162 - 169 kW		10/93→06/96	+ OE 8157216 / + OE A0018300208 / + OE 81619300042; Vers. produced by BEHR	8EW 009 160-021 Interior Blower	453
				+ OE 81619306064; 24 V; Vers. produced by BEHR	8EW 009 160-791 Interior Blower	454
				Depth [mm]: 42; L 370 mm; for vehicles with/without air conditioning; Vers. produced by BEHR; W 189 mm	8FH 351 312-421 Heat Exchanger, interior heating	455
					9ML 351 029-111 Resistor, interior blower	457
9.224 LLS, LLRS	162 kW		05/94→	+ OE A0018300208 / + OE 0018300208 / + OE 81619300042 / + OE 8157216; Vers. produced by BEHR	8EW 009 160-021 Interior Blower	453
				+ OE 0018300208 / + OE A0018300208 / + OE 81619306064; 24 V; Vers. produced by BEHR	8EW 009 160-791 Interior Blower	454
				Depth [mm]: 42; L 370 mm; for vehicles with/without air conditioning; Vers. produced by BEHR; W 189 mm	8FH 351 312-421 Heat Exchanger, interior heating	455
					9ML 351 029-111 Resistor, interior blower	457

Manufacturer - Model	Power	Displ.	Year of Constr.	Remark	Part Number	Page
MAN - L 2000						10/93→
9.225 LK, LRK, L-KI, LR-KI (LE220C)	162 kW		09/00→	Depth [mm]: 42; L 370 mm; for vehicles with/without air conditioning; Vers. produced by BEHR; W 189 mm	8FH 351 312-421 Heat Exchanger, interior heating	455
MAN - M 90						08/88→06/96
12.152 F, 12.152 FL	110 - 114 kW		12/88→05/94	+ OE 8157216 / + OE 0018300208 / + OE A0018300208 / + OE 81619300042; Vers. produced by BEHR	8EW 009 160-021	453
12.152 FK	110 - 114 kW		12/88→05/94		Interior Blower	
12.192 F, 12.192 FL	140 kW		07/90→06/96	Mounting Diameter [mm]: 59; Vers. produced by BEHR	8EW 009 160-491	454
12.192 FK	140 kW		07/90→06/96		Interior Blower	
12.192 FS, 12.192 FLS	140 kW		07/90→06/96	+ OE 81619306064; 24 V; Vers. produced by BEHR	8EW 009 160-791	454
12.232 F, 12.232 FL	169 kW		08/88→06/96		Interior Blower	
12.232 FA	169 kW		05/90→06/96	Vers. produced by BEHR	8FH 351 312-361 Heat Exchanger, interior heating	455
12.232 FAK	169 kW		05/90→06/96			
12.232 FS, 12.232 FLS	169 kW		08/88→06/96	+ OE 81259070186	9ML 351 332-121	457
12.272 F, 12.272 FL	198 kW		09/91→10/92		Resistor, interior blower	
12.272 F, 12.272 FL	198 kW		10/92→06/96	+ OE 81259070187	9ML 351 332-151	457
12.272 FA	198 kW		10/93→04/95		Resistor, interior blower	
12.272 FAK	198 kW		10/93→04/95			
12.272 FS, 12.272 FLS	198 kW		09/91→10/92			
12.272 FS, 12.272 FLS	198 kW		10/92→06/96			
14.152 FK	110 - 114 kW		12/88→05/94			
14.192 F, 14.192 FL	140 kW		07/90→06/96			
14.192 FK	140 kW		07/90→06/96			
14.192 FS, 14.192 FLS	140 kW		07/90→06/96			
14.232 F, 14.232 FL	169 kW		08/88→06/96			
14.232 FK	169 kW		08/88→06/96			
14.232 FS, 14.232 FLS	169 kW		08/88→06/96			
14.272 FK	198 kW		10/92→06/96			
14.272 FS, 14.272 FLS	198 kW		12/92→06/96			
17.192 FA	140 kW		07/90→06/96			
17.192 FAK	140 kW		07/90→06/96			
17.192 FK	140 kW		07/90→01/91			
17.192 FS, 17.192 FLS	140 kW		07/90→04/95			
17.232 FA	169 kW		02/89→06/96			
17.232 FAK	169 kW		02/89→06/96			
17.232 FS, 17.232 FLS	169 kW		08/88→04/95			
18.192 F, 18.192 FL, 18.192 FLL	140 kW		09/90→06/96			
18.192 FK	140 kW		09/90→06/96			
18.232 F, 18.232 FL, 18.232 FLL	169 kW		09/90→06/96			
18.232 FK	169 kW		09/90→06/96			
18.272 F, 18.272 FL, 18.272 FLL	198 kW		10/92→06/96			
18.272 FK	198 kW		10/92→06/96			
24.192 FNL, 24.192 FNLL, 24.192 FVL	140 kW		07/89→06/96			
24.232 FNL, 24.232 FNLL, 24.232 FVL	169 kW		07/89→06/96			
24.272 FNL, 24.272 FNLL, 24.272 FVL	198 kW		10/92→06/96			
12.152 FS, 12.152 FLS	110 - 114 kW		12/88→05/94	+ OE A0018300208 / + OE 0018300208 / + OE 81619300042 / + OE 8157216; Vers. produced by BEHR	8EW 009 160-021	453
14.272 F, 14.272 FL	198 kW		10/92→06/96		Interior Blower	
				Mounting Diameter [mm]: 59; Vers. produced by BEHR	8EW 009 160-491	454
					Interior Blower	
				+ OE 81619306064; 24 V; Vers. produced by BEHR	8EW 009 160-791	454
					Interior Blower	
				Vers. produced by BEHR	8FH 351 312-361 Heat Exchanger, interior heating	455
				+ OE 81259070186	9ML 351 332-121	457
					Resistor, interior blower	
				+ OE 81259070187	9ML 351 332-151	457
					Resistor, interior blower	
12.192 FA	140 kW		10/92→06/96	Mounting Diameter [mm]: 59; Vers. produced by BEHR	8EW 009 160-491	454
12.192 FAK	140 kW		10/92→06/96		Interior Blower	
12.232 FK	169 kW		08/88→06/96	Vers. produced by BEHR	8FH 351 312-361 Heat Exchanger, interior heating	455
12.272 FK	198 kW		09/91→10/92			
12.272 FK	198 kW		10/92→06/96			
14.192 F, 14.192 FL	137 kW		08/88→06/90	+ OE 81259070186	9ML 351 332-121	457
14.192 FK	137 kW		08/88→06/90		Resistor, interior blower	
14.192 FS, 14.192 FLS	137 kW		08/88→06/90	+ OE 81259070187	9ML 351 332-151	457
14.232 F, 14.232 FL	160 kW		05/90→04/95		Resistor, interior blower	
14.232 FS, 14.232 FLS	160 kW		05/90→04/95			
14.272 F, 14.272 FL	198 kW		09/91→10/92			
14.272 FK	198 kW		09/91→10/92			
14.272 FS, 14.272 FLS	198 kW		09/91→10/92			
17.192 F, 17.192 FL	137 kW		08/88→06/90			
17.192 FA	137 kW		02/89→06/90			
17.192 FAK	137 kW		02/89→06/90			
17.192 FK	137 kW		08/88→06/90			

Manufacturer - Model	Power	Displ.	Year of Constr.	Remark	Part Number	Page
MAN - M 90					08/88→06/96	
17.192 FS,17.192 FLS	137 kW		08/88→06/90	Mounting Diameter [mm]: 59; Vers. produced by BEHR	8EW 009 160-491	454
17.232 F,17.232 FL	160 kW		05/90→04/95		Interior Blower	
17.232 FA	160 kW		05/90→04/95	Vers. produced by BEHR	8FH 351 312-361 Heat Exchanger, interior heating	455
17.232 FAK	160 kW		05/90→04/95			
17.232 FK	160 kW		05/90→01/91			
17.232 FK	169 kW		08/88→01/91			
17.232 FS,17.232 FLS	160 kW		05/90→04/95	+ OE 81259070186	9ML 351 332-121	457
18.272 F,18.272 FL,18.272 FLL	198 kW		09/91→05/94		Resistor, interior blower	
18.272 FK	198 kW		09/91→05/94	+ OE 81259070187	9ML 351 332-151	457
24.232 FNL	160 kW		05/90→04/95		Resistor, interior blower	
24.272 FNL,24.272 FVL	198 kW		09/91→05/94			
12.222 F,12.222 FL	162 kW		05/94→06/96	Mounting Diameter [mm]: 59; Vers. produced by BEHR	8EW 009 160-491	454
12.222 FA	162 kW		05/94→06/96		Interior Blower	
12.222 FAK	162 kW		05/94→06/96	+ OE 81259070186	9ML 351 332-121	457
12.222 FK	162 kW		05/94→06/96		Resistor, interior blower	
12.262 F,12.262 FL	191 kW		08/95→06/96	+ OE 81259070187	9ML 351 332-151	457
12.262 FK	191 kW		08/95→06/96		Resistor, interior blower	
12.262 FS,12.262 FLS	191 kW		08/95→06/96			
14.162 F,14.162 FL	118 kW		08/95→06/96			
14.162 FK	118 kW		08/95→06/96			
14.162 FS,14.162 FLS	118 kW		08/95→06/96			
14.222 F,14.222 FL	162 kW		05/94→06/96			
14.222 FK	162 kW		05/94→06/96			
14.262 F,14.262 FL	191 kW		08/95→06/96			
14.262 FK	191 kW		08/95→06/96			
14.262 FS,14.262 FLS	191 kW		08/95→06/96			
18.222 F,18.222 FL,18.222 FLL	162 kW		05/94→06/96			
18.222 FK	162 kW		05/94→06/96			
18.262 F,18.262 FL,18.262 FLL	191 kW		08/95→06/96			
18.262 FK	191 kW		08/95→06/96			
24.222 FNL,24.222 FNLL,24.222 FVL	162 kW		05/94→06/96			
24.262 FNL,24.262 FNLL,24.262 FVL	191 kW		08/95→06/96			
14.152 F,14.152 FL	110 - 114 kW		12/88→04/94	+ OE 0018300208 / + OE A0018300208 / + OE 81619300042; Vers. produced by BEHR	8EW 009 160-021	453
14.152 F,14.152 FL	114 kW		05/94→06/96		Interior Blower	
14.152 FK	114 kW		05/94→06/96	Mounting Diameter [mm]: 59; Vers. produced by BEHR	8EW 009 160-491	454
14.152 FS,14.152 FLS	110 - 114 kW		12/88→05/94		Interior Blower	
14.152 FS,14.152 FLS	114 kW		05/94→06/96	+ OE 81619306064; 24 V; Vers. produced by BEHR	8EW 009 160-791	454
					Interior Blower	
				Vers. produced by BEHR	8FH 351 312-361 Heat Exchanger, interior heating	455
				+ OE 81259070186	9ML 351 332-121	457
					Resistor, interior blower	
				+ OE 81259070187	9ML 351 332-151	457
					Resistor, interior blower	
17.192 F,17.192 FL	140 kW		07/90→04/95	+ OE 8157216 / + OE 0018300208 / + OE A0018300208 / + OE 81619300042; Vers. produced by BEHR	8EW 009 160-021	453
17.232 F,17.232 FL	169 kW		08/88→04/95		Interior Blower	
				+ OE 81619306064; 24 V; Vers. produced by BEHR	8EW 009 160-791	454
					Interior Blower	
				Vers. produced by BEHR	8FH 351 312-361 Heat Exchanger, interior heating	455
MAN - M 2000 L					08/95→	
12.145 LC, LLC, LRC, LLRC	107 kW		05/01→		9ML 351 029-111	457
12.145 LK, LRK	107 kW		05/01→		Resistor, interior blower	
12.185 LC, LLC, LRC, LLRC	132 - 136 kW		05/01→			
12.185 LK, LRK	132 - 136 kW		05/01→			
12.225 LC, LLC, LLLC, LRC, LLRC	162 kW		05/01→			
12.255 LC, LLC, LLLC	180 kW		08/02→			
12.255 LK	180 kW		10/03→			
12.285 LC, LLC, LLLC	206 kW		08/02→			
12.285 LK	206 kW		10/03→			
14.185 LC, LLC, LRC, LLRC	132 - 136 kW		05/01→			
14.185 LK, LRK	132 - 136 kW		05/01→			
14.224, 14.225, LA-LF	162 kW		07/03→			
14.255 LAC, LARC	180 kW		11/02→			
14.255 LAK, LARK	180 kW		11/02→			
14.255 LA-LF	180 kW		07/03→			
14.255 LK, LRK	180 kW		11/02→			
14.264 LA-LF	191 kW		07/03→			
15.185 LC, LRC	132 - 136 kW		05/01→			
15.185 LK, LRK	132 - 136 kW		11/02→			
18.224, 18.225, L-KO, LR-KO	162 kW		05/01→			
18.255 LAC, LARC	180 kW		05/01→			

Manufacturer - Model	Power	Displ.	Year of Constr.	Remark	Part Number	Page
MAN - M 2000 L						08/95→
18.255 LAK, LARK	180 kW		05/01→		9ML 351 029-111	457
18.255 LC, LLC, LLLC, LRC, LLRC, LLLRC, (LE250B)	180 kW		09/99→		Resistor, interior blower	
18.255 LK, LK, LK, LK, LLRK	180 kW		11/02→			
18.255 L-KO, LR-KO	180 kW		05/01→			
18.263, 18.264, L-KO, LR-KO	191 kW		05/01→			
18.285 LAC, LARC (LE280B)	206 kW		09/99→			
18.285 LAK, LARK, (LE280B)	206 kW		09/99→			
20.224 LNLC, LNLLC	162 kW		05/01→			
20.255 LNLC, LNLLC	180 kW		05/01→			
20.264 LNLC, LNLLC	191 kW		05/01→			
20.284, 20.285, LNLC, LNLLC	206 kW		05/01→			
26.224, 26.225, DL-HK, DLR-HK	180 kW		11/02→			
26.255 DL-HK, DLR-HK	180 kW		11/02→			
26.284, 26.285, DL-HK, DLR-HK	206 kW		11/02→			
26.284 DL-TM, DLR-TM	206 kW		05/01→			
12.163 LC, LLC, LRC, LLRC	114 kW		08/95→	+ OE 8157216 / + OE A0018300208 / + OE 0018300208 / + OE 81619300042; Vers. produced by BEHR	8EW 009 160-021	453
12.163 LK, LRK	114 kW		08/95→		Interior Blower	
12.224, 12.225, LK, LRK	162 kW		08/95→			
12.224 LC, LLC, LRC, LLRC	162 kW		08/95→	+ OE 81619306064; 24 V; Vers. produced by BEHR	8EW 009 160-791	454
14.163 LC, LLC, LRC, LLRC	114 kW		08/95→		Interior Blower	
14.224 LC, LLC, LLLC, LRC, LLRC, LLLRC	162 kW		08/95→	Depth [mm]: 42; L 370 mm; for vehicles without air conditioning; Vers. produced by BEHR; W 189 mm	8FH 351 312-421 Heat Exchanger, interior heating	455
14.224 LK, LRK	162 kW		08/95→			
14.263, 14.264 LAC, LARC	191 kW		08/95→			
14.263, 14.264 LAK, LARK	191 kW		08/95→		9ML 351 029-111	457
14.263, 14.264 LC, LLC, LLLC, LRC, LLRC, LLLRC	191 kW		08/95→		Resistor, interior blower	
14.263, 14.264 LK, LRK	191 kW		08/95→			
15.224 LK, LRK	162 kW		08/95→			
15.263, 15.264 LC, LLC, LLLC, LRC, LLRC, LLLRC	191 kW		08/95→			
15.263, 15.264 LK, LRK	191 kW		08/95→			
18.263, 18.264, LAK, LARK	191 kW		08/95→			
18.263, 18.264, LC, LLC, LLLC, LRC, LLRC, LLLRC	191 kW		08/95→			
18.263, 18.264, LK, LK, LK, LRK, LLRK	191 kW		08/95→			
14.163 LK, LRK	114 kW		08/95→	+ OE 8157216 / + OE A0018300208 / + OE 0018300208 / + OE 81619300042; Vers. produced by BEHR	8EW 009 160-021	453
14.224 LAC, LARC	162 kW		08/95→		Interior Blower	
14.224 LAK, LARK	162 kW		08/95→			
15.163 LK, LRK	114 kW		08/95→	+ OE 81619306064; 24 V; Vers. produced by BEHR	8EW 009 160-791	454
18.224, 18.225, LAC, LARC	162 kW		08/95→		Interior Blower	
18.224, 18.225, LC, LLC, LLLC, LRC, LLRC, LLLRC	162 kW		08/95→		9ML 351 029-111	457
18.224, 18.225, LK, LK, LK, LRK, LLRK	162 kW		08/95→		Resistor, interior blower	
18.263, 18.264, LAC, LARC	191 kW		08/95→			
14.225 LAC, LARC, (LE220B)	162 kW		09/00→	Depth [mm]: 42; L 370 mm; for vehicles without air conditioning; Vers. produced by BEHR; W 189 mm	8FH 351 312-421 Heat Exchanger, interior heating	455
14.225 LAK, LARK, (LE220B)	162 kW		09/00→			
14.225 LC, LLC, LLLC, LRC, LLRC, LLLRC, (LE220B)	162 kW		09/00→			
14.225 LK, LRK (LE220B)	162 kW		09/00→		9ML 351 029-111	457
14.255 LC, LLC, LLLC, LRC, LLRC, LLLRC, (LE250B)	180 kW		09/00→		Resistor, interior blower	
14.285 LC, LLC, LLLC, LRC, LLRC, LLLRC, (LE280B)	206 kW		09/00→			
15.225 LC, LLC, LLLC, LRC, LLRC, LLLRC, (LE220B)	162 kW		09/99→			
15.225 LK, LRK, (LE220B)	162 kW		09/99→			
15.255 LC, LLC, LLLC, LRC, LLRC, LLLRC, (LE250B)	180 kW		09/99→			
15.255 LK, LRK, (LE250B)	180 kW		09/99→			
15.285 LC, LLC, LLLC, LRC, LLRC, LLLRC, (LE280B)	206 kW		09/99→			
15.285 LK, LRK, (LE280B)	206 kW		09/99→			
18.285 LC, LLC, LLLC, LRC, LLRC, LLLRC, (LE280B)	206 kW		09/99→			
15.163 LC, LLC, LRC	114 kW		08/95→	+ OE A0018300208 / + OE 0018300208 / + OE 81619300042 / + OE 8157216; Vers. produced by BEHR	8EW 009 160-021	453
					Interior Blower	
				+ OE 81619306064; 24 V; Vers. produced by BEHR	8EW 009 160-791	454
					Interior Blower	
					9ML 351 029-111	457
					Resistor, interior blower	

Manufacturer - Model	Power	Displ.	Year of Constr.	Remark	Part Number	Page
MAN - M 2000 L						08/95→
15.224 LC, LLC, LLLC, LRC, LLRC, LLLRC	162 kW		08/95→	+ OE 8157216 / + OE A0018300208 / + OE 0018300208 / + OE 81619300042; Vers. produced by BEHR	8EW 009 160-021 Interior Blower	453
				+ OE 81619306064; 24 V; Vers. produced by BEHR	8EW 009 160-791 Interior Blower	454
				Depth [mm]: 42; L 370 mm; for vehicles with/without air conditioning; Vers. produced by BEHR; W 189 mm	8FH 351 312-421 Heat Exchanger, interior heating	455
18.224, 18.225, LAK, LARK	162 kW		08/95→	+ OE 81619300042 / + OE 0018300208 / + OE A0018300208 / + OE 8157216; Vers. produced by BEHR	8EW 009 160-021 Interior Blower	453
				+ OE 81619306064; 24 V; Vers. produced by BEHR	8EW 009 160-791 Interior Blower	454
					9ML 351 029-111 Resistor, interior blower	457
MAN - M 2000 M						08/95→12/05
14.224 MAK	162 kW		08/95→12/05	Depth [mm]: 42; L 370 mm; for vehicles with/without air conditioning; Vers. produced by BEHR; W 189 mm	8FH 351 312-441 Heat Exchanger, interior heating	456
14.224 MC, MLC, MLLC	162 kW		08/95→12/05			
14.224 MK	162 kW		08/95→12/05			
14.224 MLS, MLRS	162 kW		08/95→12/05			
14.264 MC, MLC, MLLC	191 kW		08/95→12/05			
14.264 MLS, MLRS	191 kW		08/95→12/05			
14.285 MLC, MLLC (ME280C)	206 kW		09/99→12/05			
18.224 MAC, MARC	162 kW		08/95→12/05			
18.224 MAK, MARK	162 kW		08/95→12/05			
18.224 MC, MLC, MLLC, MRC, MLRC, MLLRC	162 kW		08/95→12/05			
18.224 MK, 18.224 MLK, MRK, MLRK	162 kW		08/95→12/05			
18.224 MLS, MLRS	162 kW		08/95→12/05			
18.264 MAC, MARC	191 kW		08/95→12/05			
18.264 MAK, MARK	191 kW		08/95→12/05			
18.264 MC, MLC, MLLC, MRC, MLRC, MLLRC	191 kW		08/95→12/05			
18.264 MK, 18.264 MLK, MRK, MLRK	191 kW		08/95→12/05			
18.264 MLS, MLRS	191 kW		08/95→12/05			
25.224 MNLC, MNLLC, MNLRC, MNLLRC, MVLC	162 kW		08/95→12/05			
25.264 MNLC, MNLLC, MNLRC, MNLLRC, MVLC	191 kW		08/95→12/05			
MAN - NM						
NM 152	110 kW		05/90→10/93	Depth [mm]: 42; L 370 mm; for vehicles with/without air conditioning; Vers. produced by BEHR; W 189 mm	8FH 351 312-421 Heat Exchanger, interior heating	455
NM 182, NM 192	130 - 140 kW		05/90→03/97			
NM 223	162 kW		08/87→			
MAN - SM						11/87→02/95
SM 152	110 - 114 kW		11/87→04/94	Depth [mm]: 42; L 370 mm; for vehicles with/without air conditioning; Vers. produced by BEHR; W 189 mm	8FH 351 312-421 Heat Exchanger, interior heating	455
SM 182, SM 192	130 - 140 kW		11/87→02/95			
MAN - TGA						04/00→
18.310, 18.320 FAC, FHLC	228 - 235 kW		05/04→	4 pol	5HL 351 029-061 Regulator, passenger compartment fan	456
18.310, 18.320 FAK, FAK-L, FALK, FALK-L, FHLK, FHLK/M	228 - 235 kW		05/04→			
18.310, 18.320 FAS, FALS, FHLS, FHLS/M	228 - 235 kW		05/04→	Depth [mm]: 42; + OE 81619016166; L 370 mm; for vehicles with/without air conditioning; Vers. produced by BEHR; W 189 mm	8FH 351 312-551 Heat Exchanger, interior heating	456
18.310, 18.320 FC, FLC, FLLC, FLLC/N, FLLW, FLLW/N	228 - 235 kW		05/04→			
18.310, 18.320 FK, FK-L, FLK, FLK/M	228 - 235 kW		05/04→	Control Valve	9XL 351 029-071 Control Valve, coolant	458
18.310, 18.320 FLS, FLRS, FLLS, FLLRS	228 - 235 kW		05/04→	Vers. produced by BEHR	9XL 351 341-071 Control Valve, coolant	459
18.310 FAK, FAK-L, FALK	228 kW		09/02→			
18.310 FAS, FARS	228 kW		09/02→			
18.350, 18.360 FAC, FHLC	257 - 265 kW		05/04→			
18.350, 18.360 FAK, FAK-L, FALK, FALK-L, FHLK, FHLK/M	257 - 265 kW		05/04→			
18.350, 18.360 FAS, FALS, FHLS, FHLS/M	257 - 265 kW		05/04→			
18.350, 18.360 FC, FLC, FLLC, FLLRC, FLLC/N, FLLW, FLLW/N	257 - 265 kW		05/04→			
18.350, 18.360 FK, FK-L, FLK, FLK/M,	257 - 265 kW		05/04→			
18.350 FLS, FLS/N, FLS/M, FLS-TS, FLLS, FLLS/N, FLLRS	257 kW		05/04→			
18.360 FAC, FARC	265 kW		09/02→			

Manufacturer - Model	Power	Displ.	Year of Constr.	Remark	Part Number	Page
MAN - TGA						04/00→
18.360 FAK, FALK, FAK-L, FALK-L	265 kW		09/02→	4 pol	5HL 351 029-061 Regulator, passenger compartment fan	456
18.360 FAS, FALS, FARS	265 kW		09/02→			
18.390, 18.400 FAC, FHLC	287 - 294 kW		05/04→	Depth [mm]: 42; + OE 81619016166; L 370 mm; for vehicles with/without air conditioning; Vers. produced by BEHR; W 189 mm	8FH 351 312-551 Heat Exchanger, interior heating	456
18.390, 18.400 FAK, FAK-L, FALK, FALK-L, FHLK, FHLK/M	287 - 294 kW		05/04→			
18.390, 18.400 FAS, FALS, FHLS, FHLS/M	287 - 294 kW		05/04→	Control Valve	9XL 351 029-071 Control Valve, coolant	458
18.390, 18.400 FC, FLC, FLLC, FLLC/N, FLLW, FLLW/N	287 - 294 kW		05/04→	Vers. produced by BEHR	9XL 351 341-071 Control Valve, coolant	459
18.390, 18.400 FK, FK-L, FLK, FLK/M	287 - 294 kW		05/04→			
18.390 FLS, FLS-TS, FLS/M, FLLS, FLLS/N, FLLS/M, FLLRS	287 kW		05/04→			
18.410, 18420 FAK, FAK-L, FALK	301 - 309 kW		09/02→			
18.410 FAC, FARC	301 kW		09/02→			
18.410 FAS, FALS, FARS	301 kW		09/02→			
18.430, 18.440 FAC, FHLC	316 - 324 kW		05/04→			
18.430, 18.440 FAK, FALK, FALK-L, FHLK, FHLK/M	316 - 324 kW		05/04→			
18.430, 18.440 FAS, FALS, FHLS, FHLS/M	316 - 324 kW		05/04→			
18.430, 18.440 FC, FLC, FLLC, FLLW, FLLW/N, FLLRC, FLLRW	316 - 324 kW		05/04→			
18.430, 18.440 FK, FK-L, FLK, FLK/M	316 - 324 kW		05/04→			
18.430 FLS, FLS/M, FLS-TS, FLLS, FLLS/N, FLLRS, FLRS	316 kW		05/04→			
18.480 FAC, FARC	353 kW		09/02→			
18.480 FAK, FAK-L, FALK	353 kW		09/02→			
18.480 FAS, FALS, FARS	353 kW		09/02→			
19.360 FS/M-WW, FRS/M-WW	265 kW		05/04→			
19.410 FS/M-WW, FRS/M-WW	301 kW		05/04→			
19.460 FS/M-WW, FRS/M-WW	338 kW		05/04→			
19.480 FS/M-WW, FRS/M-WW	353 kW		05/04→			
24.350, 24.360 FNLLC, FNLLW/N, FNLLRW	257 - 265 kW		05/04→			
24.350, 24.360 FPLS, FPLRS	257 - 265 kW		02/04→			
24.390, 24.400 FNLLC/N, FNLLW/N, FNLLRC, FNLLRW	287 - 294 kW		05/04→			
24.390, 24.400 FPLS, FPLRS	287 - 294 kW		05/04→			
24.430, 24.440 FNLLC/N, FNLRC, FNLLW	316 - 324 kW		05/04→			
24.430, 24.440 FPLS, FPLRS	316 - 324 kW		05/04→			
26.310, 26.320 FDC, FDRC, FDC/M, FDRC/M, FDLC, FNHLC, FVHLC	228 - 235 kW		05/04→			
26.310, 26.320 FDH, FDHC, FDHC/M	228 - 235 kW		06/05→			
26.310, 26.320 FDHK	228 - 235 kW		06/05→			
26.310, 26.320 FDHS, FDHS/M	228 - 235 kW		06/05→			
26.310, 26.320 FDH-TM	228 - 235 kW		06/05→			
26.310, 26.320 FDK, FDLK	228 - 235 kW		05/04→			
26.310, 26.320 FDS, FDS/M, FDLS, FDRS, FDRS/M, FNHLS, FDLRS	228 - 235 kW		05/04→			
26.310, 26.320 FD-TM	228 - 235 kW		06/05→			
26.310, 26.320 FNLC, FNLLC, FNLRC, FNLLRC, FNLLW	228 - 235 kW		05/04→			
26.310, 26.320 FNLS, FNLLS, FNLRS, FNLLRS	228 - 235 kW		05/04→			
26.310, 26.320 FVHL-KO	228 - 235 kW		06/05→			
26.310, 26.320 FVLC	228 - 235 kW		02/04→			
26.310, 26.320 FVL-KO	228 - 235 kW		02/04→			
26.310 FDAC, FDARC	228 kW		02/02→			
26.310 FDAK	228 kW		02/02→			
26.310 FDAS, FDARS	228 kW		02/02→			
26.350, 26.360 FDC, FDRC, FDC/M, FDRC/M, FDLC, FDLRC, FNHLC	257 - 265 kW		05/04→			
26.350, 26.360 FDHK, FDHLK	257 - 265 kW		05/04→			
26.350, 26.360 FDHS, FDHS/M, FDHLS	257 - 265 kW		05/04→			
26.350, 26.360 FDH-TM	257 - 265 kW		05/04→			
26.350, 26.360 FDK, FDLK, FDRK	257 - 265 kW		05/04→			
26.350, 26.360 FDS, FDS/M, FDLS, FDRS, FNHLS, FPHLS	257 - 265 kW		05/04→			
26.350, 26.360 FD-TM	257 - 265 kW		02/04→			
26.350, 26.360 FNLC, FNLLC, FNLLW, FNLRC, FNLLRC	257 - 265 kW		05/04→			

Manufacturer - Model	Power	Displ.	Year of Constr.	Remark	Part Number	Page
MAN - TGA						04/00→
26.350, 26.360 FNLS, FNLLS, FNLRs, FNLLRS, FPLS, FPLRS	257 - 265 kW		05/04→	4 pol	5HL 351 029-061 Regulator, passenger compartment fan	456
26.350, 26.360 FVHL-KO	257 - 265 kW		06/05→			
26.350, 26.360 FVL-KO	257 - 265 kW		01/04→			
26.350 FDHC, FDHC/M	257 kW		04/05→	Depth [mm]: 42; + OE 81619016166; L 370 mm; for vehicles with/without air conditioning; Vers. produced by BEHR; W 189 mm	8FH 351 312-551 Heat Exchanger, interior heating	456
26.360 FDAC, FDARC	265 kW		02/02→			
26.360 FDAK, FDALK	265 kW		02/02→			
26.360 FDAS, FDARS	265 kW		02/02→			
26.360 FD-TM, FDR-TM	265 kW		01/01→			
26.390, 26.400 FDC, FDRc, FDLRC, FDRc/M, FDLC, FNHLC, FVHLC	287 - 294 kW		05/04→	Vers. produced by BEHR	9XL 351 029-071 Control Valve, coolant	458
26.390, 26.400 FDHC, FDHC/M, FDHLC	287 - 294 kW		06/05→			
26.390, 26.400 FDHK, FDHLK	287 - 294 kW		06/05→			
26.390, 26.400 FDHS, FDHS/M, FDHLS	287 - 294 kW		06/05→			
26.390, 26.400 FDK, FDLK	287 - 294 kW		05/04→			
26.390, 26.400 FDS, FDS/M, FDLs, FDLRS, FNHLS, FPHLS, FVHLS	287 - 294 kW		05/04→			
26.390, 26.400 FD-TM	287 - 294 kW		05/04→			
26.390, 26.400 FNLC, FNLLC, FNLLW, FNLRc, FNLLRC	287 - 294 kW		05/04→			
26.390, 26.400 FNLS, FNLLS, FNLRs, FNLLRS, FPLS, FPLRS	287 - 294 kW		05/04→			
26.390, 26.400 FVHL-KO	287 - 294 kW		06/05→			
26.390, 26.400 FVL-KO	287 - 294 kW		02/04→			
26.410 FDAC, FDARC	301 kW		02/02→			
26.410 FDAK, FDALK	301 kW		02/02→			
26.410 FDAS, FDALS, FDARS	301 kW		02/02→			
26.410 FDC, FDLC, FDLC/M, FDLC-WW; FDRc-WW, FDLRC-WW	301 kW		01/01→			
26.430, 26.440, FNLC, FNLLC, FNLLW, FNLRc, FNLLRC, FVLC	316 - 324 kW		05/04→			
26.430, 26.440, FNLS, FNLLS, FNLRs, FNLLRS, FPLS, FPLRS	316 - 324 kW		05/04→			
26.430, 26.440 FDC, FDRc, FDLC, FDLRC, FDLC/M, FNHLC, FVHLC	316 - 324 kW		05/04→			
26.430, 26.440 FDHC, FDHC/M, FDHLC	316 - 324 kW		06/05→			
26.430, 26.440 FDHK, FDHLK	316 - 324 kW		06/05→			
26.430, 26.440 FDHS, FDHS/M, FDHLS	316 - 324 kW		06/05→			
26.430, 26.440 FDH-TM	316 - 324 kW		06/05→			
26.430, 26.440 FDK, FDLK	316 - 324 kW		05/04→			
26.430, 26.440 FDS, FDLs, FDRs, FDLRS, FNHLS, FPHLS, FVHLS	316 - 324 kW		02/04→			
26.430, 26.440 FD-TM	316 - 324 kW		05/04→			
26.430, 26.440 FVLH-KO	316 - 324 kW		06/05→			
26.480 FDAC, FDALC, FDARC	353 kW		09/02→			
26.480 FDAK, FDALK	353 kW		09/02→			
26.480 FDAS, FDALS, FDARS	353 kW		09/02→			
32.350, 32.360 FFDRc	257 - 265 kW		05/04→			
32.350, 32.360 FFD-TM, FFDR-TM	257 - 265 kW		02/04→			
32.390, 32.400 FFDRc	287 - 294 kW		05/04→			
32.390, 32.400 FFD-TM, FFDR-TM	287 - 294 kW		05/04→			
32.430, 32.440 FFDRc	316 - 324 kW		05/04→			
32.430, 32.440 FFD-TM, FFDR-TM	316 - 324 kW		05/04→			
33.350, 33.360 FDAC, FDHC, FDHC/M	257 - 265 kW		06/05→			
33.350, 33.360 FDAK, FDHK	257 - 265 kW		06/05→			
33.350, 33.360 FDAS, FDHS, FDHS/M	257 - 265 kW		06/05→			
33.350, 33.360 FDC, FDC/M, FDLC, FDRc	257 - 265 kW		05/04→			
33.350, 33.360 FDK, FDLK, FDRK	257 - 265 kW		05/04→			
33.350, 33.360 FDS, FDLs, FDS/M, FDRs	257 - 265 kW		05/04→			
33.360 FDAC, FDARC, FDAC-WW	265 kW		09/02→			
33.360 FDAK, FDAK-WW	265 kW		09/02→			
33.360 FDAS, FDAS-WW	265 kW		09/02→			

Manufacturer - Model	Power	Displ.	Year of Constr.	Remark	Part Number	Page
MAN - TGA						04/00→
33.390, 33.400 FDAC, FDHC, FDHC/M	287 - 295 kW		06/05→	4 pol	5HL 351 029-061 Regulator, passenger compartment fan	456
33.390, 33.400 FDAK, FDHK	287 - 295 kW		06/05→			
33.390, 33.400 FDAS, FDHS, FDHS/M	287 - 295 kW		06/05→	Depth [mm]: 42; + OE 81619016166; L 370 mm; for vehicles with/without air conditioning; Vers. produced by BEHR; W 189 mm	8FH 351 312-551 Heat Exchanger, interior heating	456
33.390, 33.400 FDC, FDLC, FDRC, FDC/M	287 - 294 kW		05/04→			
33.390, 33.400 FDK, FDLK, FDRK	287 - 294 kW		05/04→		9XL 351 029-071 Control Valve	458
33.390, 33.400 FDS, FDLS, FDLRS, FDRS, FDS/M	287 - 294 kW		05/04→	Vers. produced by BEHR	9XL 351 341-071 Control Valve, coolant	459
33.410 FDAC, FDAC-WW, FDALC	301 kW		09/02→			
33.410 FDAK, FDAK-WW, FDALK	301 kW		09/02→			
33.410 FDAS, FDAS-WW, FDALS	301 kW		09/02→			
33.430, 33.440 FDAC, FDALC, FDHC, FDHC/M	316 - 324 kW		06/05→			
33.430, 33.440 FDAK, FDALK, FDHK	316 - 324 kW		06/05→			
33.430, 33.440 FDAS, FDALS, FDHS	316 - 324 kW		06/05→			
33.430, 33.440 FDC, FDLC, FDRC, FDLRC, FDC/M	316 - 324 kW		05/04→			
33.430, 33.440 FDK, FDLK, FDRK	316 - 324 kW		05/04→			
33.430, 33.440 FDS, FDLS, FDRS, FDLRS, FDS/M	316 - 324 kW		05/04→			
33.480 FDAC, FDAC-WW, FDALC, FDARC	353 kW		09/02→			
33.480 FDAK, FDAK-WW, FDALK	353 kW		09/02→			
33.480 FDAS, FDAS-WW, FDARS, FDALS	353 kW		09/02→			
33.530 FDAK, FDALK	390 kW		09/02→			
33.530 FDAS, FDALS	390 kW		09/02→			
35.310, 35.320 FFDC, FFDLC	228 - 235 kW		02/04→			
35.310, 35.320 FFDK, FFDLK	228 - 235 kW		02/04→			
35.310, 35.320 FFD-TM	228 - 235 kW		02/04→			
35.350, 35.360 FFDC, FFDRC, FFDLC	257 - 265 kW		02/04→			
35.350, 35.360 FFDK, FFDRC, FFDLK	257 - 265 kW		02/04→			
35.350, 35.360 FFD-TM	257 - 265 kW		02/04→			
35.390, 35.400 FFDC, FFDRC, FFDLC	287 - 294 kW		02/04→			
35.390, 35.400 FFDK, FFDRC, FFDLK	287 - 294 kW		02/04→			
35.390, 35.400 FFD-TM	287 - 294 kW		02/04→			
35.430, 35.440 FFDC, FFDRC, FFDLC	316 - 324 kW		02/04→			
35.430, 35.440 FFDK, FFDRC, FFDLK	316 - 324 kW		02/04→			
35.430, 35.440 FFD-TM	316 - 324 kW		02/04→			
37.310, 37.320 FFDC	228 - 235 kW		12/04→			
37.310, 37.320 FFDK	228 - 235 kW		12/04→			
37.310, 37.320 FFD-TM	228 - 235 kW		12/04→			
37.350, 37.360 FFDC	257 - 265 kW		12/04→			
37.350, 37.360 FFDK	257 - 265 kW		12/04→			
37.350, 37.360 FFD-TM	257 - 265 kW		12/04→			
37.390, 37.400 FFDC	287 - 294 kW		12/04→			
37.390, 37.400 FFDK	287 - 294 kW		12/04→			
37.390, 37.400 FFD-TM	287 - 294 kW		12/04→			
37.430, 37.440 FFDC	316 - 324 kW		12/04→			
37.430, 37.440 FFDK	316 - 324 kW		12/04→			
37.430, 37.440 FFD-TM	316 - 324 kW		12/04→			
40.410 FDK-WW	301 kW		04/04→			
40.410 FDS-WW	301 kW		04/04→			
40.430 FDK-WW, FDRK	316 kW		06/05→			
40.430 FDS-WW, FDRS	316 kW		06/05→			
40.460 FDK-WW	338 kW		04/04→			
40.460 FDS-WW	338 kW		04/04→			
40.480 FDK-WW	353 kW		04/04→			
40.480 FDS-WW	353 kW		04/04→			
41.350, 41.360 FFDC, FFDRC/M, FFDRC	257 - 265 kW		12/04→			
41.350, 41.360 FFDK, FFDRC	257 - 265 kW		12/04→			
41.350, 41.360 FFD-TM	257 - 265 kW		12/04→			
41.360 FFDC, FFDRC/M, FFDRC-WW, FFDRC	265 kW		01/03→			

Manufacturer - Model	Power	Displ.	Year of Constr.	Remark	Part Number	Page
MAN - TGA						04/00→
41.360 FFDK-WW	265 kW		09/03→	4 pol	5HL 351 029-061	456
41.390, 41.400 FFDC, FFDRK, FFDC/M	287 - 294 kW		12/04→		Regulator, passenger compartment fan	
41.390, 41.400 FFDK, FFDRK	287 - 294 kW		12/04→	Depth [mm]: 42; + OE 81619016166; L 370 mm; for vehicles with/without air conditioning; Vers. produced by BEHR; W 189 mm	8FH 351 312-551	456
41.390, 41.400 FFD-TM	287 - 294 kW		12/04→		Heat Exchanger, interior heating	
41.410 FFDC-WW, FDRC	301 kW		09/03→	Control Valve	9XL 351 029-071	458
41.410 FFDK-WW	301 kW		09/03→		Control Valve, coolant	
41.430, 41.440 FFDC, FFDRK, FFDC/M	316 - 324 kW		12/04→	Vers. produced by BEHR	9XL 351 341-071	459
41.430, 41.440 FFDK, FFDRK	316 - 324 kW		12/04→		Control Valve, coolant	
41.430, 41.440 FFD-TM	316 - 324 kW		12/04→			
41.460 FFDC-WW, FFDRK	338 kW		09/03→			
41.460 FFDK-WW	338 kW		09/03→			
41.480 FFDC-WW, FFDRK	353 kW		06/05→			
41.480 FFDK-WW	353 kW		06/05→			
41.530 FVDS, FVDLS	390 kW		09/02→			
18.310, 18320 FC, FLC, FRC, FLLC, FLLC/N, FLLW, FLLRC, FLLRW	228 - 235 kW		04/00→	4 pol	5HL 351 029-061	456
18.310, 18320 FK, FLK, FK-L, FLRK	228 - 235 kW		12/00→	Rated Power [W]: 300; 24 V; with integrated regulator; Vers. produced by BEHR	8EW 009 158-151	452
18.310 FLS, FLLS, FLLS/N, FLS-TS, FLRS, FLLRS	228 kW		04/00→	Depth [mm]: 42; + OE 81619016166; L 370 mm; for vehicles with/without air conditioning; Vers. produced by BEHR; W 189 mm	8FH 351 312-551	456
18.360 FC, FLC, FRC, FLLC, FLLC/N, FLLW, FLLRW	265 kW		04/00→		Heat Exchanger, interior heating	
18.360 FK, FLK, FK-L, FLRK	265 kW		12/00→	Control Valve	9XL 351 029-071	458
18.360 FLS, FLLS, FLLS/N, FLS-TS, FLRS, FLLRS	265 kW		04/00→		Control Valve, coolant	
18.410, 18420 FC, FRC, FLC, FLRC, FLLC, FLLC/N, FLLW, FLLRC	301 - 309 kW		04/00→	Vers. produced by BEHR	9XL 351 341-071	459
18.410, 18420 FK, FK-L, FLK, FLRK	301 - 309 kW		12/00→		Control Valve, coolant	
18.460 FC, FLC, FRC, FLLC, FLLC/N, FLLW, FLLRC, FLLRW	338 kW		04/00→			
18.460 FK, FK-L, FLK, FLRK	338 kW		12/00→			
18.460 FLS, FLLS, FLLS/N, FLS-TS, FLRS, FLLRS	338 kW		04/00→			
18.480 FC, FLC, FLLC, FLLW, FLLRW, FLLRC	353 kW		09/02→			
18.480 FK, FLK, FK-L	353 kW		09/02→			
18.480 FLS, FLLS, FLLS/N, FLS-TS, FLRS-WW	353 kW		09/02→			
18.510 FC, FLC, FRC, FLLC, FLLC/N, FLLW, FLLRC, FLLRW	375 kW		09/00→			
18.510 FLS, FLLS, FLLS/N, FLRS, FLLRS	375 kW		04/00→			
18.530 FC, FLC, FLLC, FLLC/N, FLLW, FLLRC, FLLRW	390 kW		09/02→			
18.530 FLS, FLLS, FLLS/N	390 kW		09/02→			
24.360 FNLLC/N, FNLLW, FNLLRW, FNLLRC	265 kW		09/01→			
24.410 FNLLC/N, FNLLW, FNLLRW	301 kW		09/01→			
24.460 FNLLC/N, FNLLW, FNLLRC, FNLLRW	338 kW		09/01→			
24.480 FNLLC/N, FNLLW, FNLLRC, FNLLRW	353 kW		09/02→			
24.510 FNLLC/N, FNLLW, FNLLRW	375 kW		09/01→			
24.530 FNLLC/N, FNLLW, FNLLRW	390 kW		09/01→			
26.310 FDC, FDLC, FDRC, FDLC/M, FDLRC	228 kW		01/01→			
26.310 FDK, FDLK, FDRK	228 kW		09/02→			
26.310 FDS, FDLs, FDLs/M, FDLRS	228 kW		01/01→			
26.310 FD-TM, FDR-TM	228 kW		10/00→			
26.310 FNLC, FNLLC, FVLC, FNLLW, FNLRK, FNLLRW	228 kW		09/00→			
26.310 FPLS, FVLS, FNLS, FNLLS, FPLRS, FNLRS, FVLRs	228 kW		12/00→			
26.310 FVL-KO	228 kW		12/00→			
26.360 FDC, FDLC, FDLC/M, FDRC, FDLRC-WW	265 kW		01/01→			
26.360 FDK, FDLK, FDRK, FDLRK	265 kW		09/02→			
26.360 FDLs, FDLs/M, FDLRS, FDLRS/M, FDLRS-WW, FDRS	265 kW		09/03→			

Manufacturer - Model	Power	Displ.	Year of Constr.	Remark	Part Number	Page
MAN - TGA						04/00→
26.360 FDS, FDLS, FNLS, FNLLS, FPLS, FPLRS, FVLS, FVLS	265 kW		12/00→	4 pol	5HL 351 029-061 Regulator, passenger compartment fan	456
26.360 FNLC, FNLLC, FNLLW, FNLLRC, FNLLRW, FVLC	265 kW		09/00→	Rated Power [W]: 300; 24 V; with integrated regulator; Vers. produced by BEHR	8EW 009 158-151 Interior Blower	452
26.360 FVL-KO	265 kW		12/00→	Depth [mm]: 42; + OE 81619016166; L 370 mm; for vehicles with/without air conditioning; Vers. produced by BEHR; W 189 mm	8FH 351 312-551 Heat Exchanger, interior heating	456
26.410 FDK, FDRK, FDLK, FDLRK	301 kW		09/01→			
26.410 FDS, FDLS, FDLS/M, FDLS-WW, FDRS-WW, FDLRS-WW	301 kW		06/01→	Control Valve	9XL 351 029-071 Control Valve, coolant	458
26.410 FD-TM, FDR-TM	301 kW		01/01→	Vers. produced by BEHR	9XL 351 341-071 Control Valve, coolant	459
26.410 FNLC, FNLLC, FNLLW, FNLR, FNLLRC, FVLC	301 kW		04/00→			
26.410 FPLS, FPLRS, FVLS, FNLS, FNLLS	301 kW		12/00→			
26.410 FVL-KO	301 kW		12/00→			
26.460 FDC, FDLC, FDLC/M, FDLC-WW, FDR, FDLRC-WW	338 kW		01/01→			
26.460 FDK, FDLK, FDLRK	338 kW		01/01→			
26.460 FDS, FDLS, FDLS/M, FDLS-WW, FDRS-WW, FDLRS-WW	338 kW		06/01→			
26.460 FD-TM, FDR-TM	338 kW		01/01→			
26.460 FNLC, FNLR, FNLLC, FNLLRW, FNLLRC	338 kW		04/00→			
26.460 FPLS, FPLRS, FVLS, FVLS, FNLS, FNLLS, FNLR	338 kW		12/00→			
26.460 FVLC	338 kW		02/01→			
26.460 FVL-KO	338 kW		12/00→			
26.480 FDC, FDLC, FDR, FDLC/M, FDLRC-WW	353 kW		09/02→			
26.480 FDK, FDLK, FDLRK	353 kW		09/02→			
26.480 FDS, FDLS, FDLS/M, FDLRS-WW, FDRS	353 kW		09/02→			
26.480 FNLC, FNLLC, FVLC, FNLLRC, FVLLW	353 kW		09/02→			
26.480 FNLS, FNLLS, FNLR, FPLS, FVLS	353 kW		09/02→			
26.480 FVL-KO	353 kW		09/02→			
26.510 FDC, FDC/M, FDR, FDLC, FDLC/M, FDLRC	375 kW		01/01→			
26.510 FDS, FDLS, FDLS/M, FDRS, FDLRS	375 kW		01/01→			
26.510 FNLC, FNLLC, FNLLW, FNLLRC, FVLC	375 kW		12/00→			
26.510 FNLS, FNLLS, FNLR, FPLS, FVLS	375 kW		12/00→			
26.530 FDC, FDLC, FDC/M, FDLRC	390 kW		01/01→			
26.530 FDK, FDLK, FDLRK	390 kW		09/02→			
26.530 FDS, FDLS, FDLS/M, FDLRS	390 kW		01/01→			
26.530 FNLC, FNLLC, FNLLW, FNLLRC, FVLC, FVLR	390 kW		09/02→			
26.530 FNLS, FNLLS, FNLR, FPLS, FVLS, FVLS	390 kW		09/02→			
28.310 FNLC, FNLLC, FNLR	228 kW		09/02→			
28.310 FNLS, FNLR	228 kW		09/02→			
28.360 FNLC, FNLLC	265 kW		09/02→			
28.360 FNLS, FNLR	265 kW		09/02→			
28.410 FNLC, FNLLC, FNLR	301 kW		09/02→			
28.410 FNLS, FNLR	301 kW		09/02→			
28.460 FNLC, FNLLC, FNLR	338 kW		09/02→			
28.460 FNLS, FNLR	338 kW		09/02→			
28.480 FNLC, FNLLC, FNLR	353 kW		09/02→			
28.480 FNLS, FNLR	353 kW		09/02→			
28.510 FNLC, FNLLC, FNLR	375 kW		09/02→			
28.510 FNLS, FNLR	375 kW		09/02→			
28.530 FNLC, FNLLC, FNLR	390 kW		09/02→			
28.530 FNLS, FNLR	390 kW		09/02→			
32.310 FFDC, FFDLC, FFDLRC	228 kW		01/02→			
32.310 FFDK, FFDLK	228 kW		01/02→			
32.310 FFD-TM	228 kW		01/02→			
32.360 FFDC, FFDLC, FFDLRC	265 kW		01/02→			
32.360 FFDK, FFDLK	265 kW		01/02→			
32.360 FFD-TM	265 kW		01/02→			
32.410 FFDC, FFDLC, FFDRC, FFDLRC	301 kW		01/02→			
32.410 FFDK, FFDLK	301 kW		01/02→			
32.410 FFD-TM	301 kW		01/02→			

Manufacturer - Model	Power	Displ.	Year of Constr.	Remark	Part Number	Page
MAN - TGA						04/00→
32.460 FFDC, FFDLC, FFDLRC	338 kW		01/02→	4 pol	5HL 351 029-061	456
32.460 FFDK, FFDLK	338 kW		01/02→		Regulator, passenger compartment fan	
32.460 FFD-TM	338 kW		01/02→			
32.480 FFDC, FFDLC, FFDLRC	353 kW		09/02→	Rated Power [W]: 300; 24 V; with integrated regulator; Vers. produced by BEHR	8EW 009 158-151	452
32.480 FFDK, FFDLK	353 kW		09/02→		Interior Blower	
32.480 FFD-TM	353 kW		09/02→			
33.360 FDC, FDC-WW, FDLC/M, FDRC-WW, FDLRC	265 kW		10/00→	Depth [mm]: 42; + OE 81619016166; L 370 mm; for vehicles with/without air conditioning; Vers. produced by BEHR; W 189 mm	8FH 351 312-551	456
33.360 FDK, FDK-WW, FDLK, FDRK-WW	265 kW		01/01→		Heat Exchanger, interior heating	
33.360 FDS, FDS-WW, FDLS, FDLRS, FDRS-WW	265 kW		10/00→			
33.360 FD-TM, FDR-TM	265 kW		01/01→	Control Valve	9XL 351 029-071	458
33.410 FDC, FDC-WW, FDLC, FDLRC, FDRC-WW	301 kW		10/00→		Control Valve, coolant	
33.410 FDK, FDK-WW, FDLK, FDRK-WW	301 kW		10/00→			
33.410 FDS, FDS-WW, FDLS, FDLS/M, FDLRS, FDRS-WW	301 kW		10/00→	Vers. produced by BEHR	9XL 351 341-071	459
33.410 FD-TM, FDR-TM	301 kW		10/00→		Control Valve, coolant	
33.460 FDC, FDC-WW, FDLC, FDLRC, FDRC-WW	338 kW		09/02→			
33.460 FDK, FDK-WW, FDLK, FDRK-WW	338 kW		09/02→			
33.460 FDS, FDLS, FDLS/M, FDLRS, FDRS-WW	338 kW		09/02→			
33.460 FD-TM, FDR-TM	338 kW		09/02→			
33.480 FDC, FDC-WW, FDLC, FDLRC, FDRC-WW	353 kW		09/02→			
33.480 FDK, FDK-WW, FDLK, FDRK-WW	353 kW		09/02→			
33.480 FDS, FDS-WW, FDLS, FDLS/M, FDLRS, FDRS-WW	353 kW		09/02→			
33.480 FD-TM	353 kW		09/02→			
33.510 FDC, FDC/M, FDLC, FDLRC, FDLRC	375 kW		09/02→			
33.510 FDS, FDLS/M, FDRS, FDLRS/M	375 kW		09/02→			
33.530 FDC, FDC/M, FDLC, FDLRC, FDLRC	390 kW		09/02→			
33.530 FDK, FDLK	390 kW		07/03→			
33.530 FDS, FDLS, FDLS/M, FDRS, FDLRS	390 kW		07/03→			
35.310 FFDC, FFDLC	228 kW		06/03→			
35.310 FFDK, FFDLK	228 kW		06/03→			
35.360 FFDC, FFDLC	265 kW		10/03→			
35.360 FFDK, FFDLK	265 kW		10/03→			
35.410 FFDC, FFDLC	301 kW		10/03→			
35.410 FFDK, FFDLK	301 kW		10/03→			
35.460 FFDC, FFDLC	338 kW		10/03→			
35.460 FFDK, FFDLK	338 kW		10/03→			
35.480 FFDC, FFDLC	353 kW		10/03→			
35.480 FFDK, FFDLK	353 kW		10/03→			
35.530 FFDC, FFDLC	390 kW		04/04→			
35.530 FFDK, FFDLK	390 kW		04/04→			
18.310 FAC, FARC	228 kW		09/02→	4 pol	5HL 351 029-061	456
24.540 FNLLC/N, FLLCW/N	397 kW		01/06→		Regulator, passenger compartment fan	
37.480 FFD-TM	353 kW		02/06→			
40.390, 40.400 FDK-WW, FDRK	287 - 294 kW		06/05→	Control Valve	9XL 351 029-071	458
40.390, 40.400 FDS-WW, FDRS	287 - 294 kW		06/05→		Control Valve, coolant	
41.660 FVDS, FVDLS	485 kW		09/02→			
				Vers. produced by BEHR	9XL 351 341-071	459
					Control Valve, coolant	
18.360 FLS, FLLS, FLRS, FLLRS	265 kW		01/06→	Depth [mm]: 42; + OE 81619016166; L 370 mm; for vehicles with/without air conditioning; Vers. produced by BEHR; W 189 mm	8FH 351 312-551	456
18.400 FLS, FLLS, FLRS, FLLRS	294 kW		10/05→		Heat Exchanger, interior heating	
18.440 FLS, FLLS, FLRS, FLLRS	324 kW		09/05→			
18.480 FAC	353 kW		02/06→	Vers. produced by BEHR	9XL 351 341-071	459
18.480 FAK, FALK	353 kW		02/06→		Control Valve, coolant	
18.480 FAS, FALS	353 kW		02/06→			
18.480 FLS, FLLS, FLRS, FLLRS	353 kW		01/06→			
18.530 FAC	390 kW		04/04→			
18.530 FAK, FALK	390 kW		04/04→			
18.530 FAS, FALS	390 kW		04/04→			
18.540 FLC, FLRC, FLLC, FLLRC, FLLW	397 kW		08/06→			
18.540 FLS, FLRS, FLLS, FLLRS	397 kW		08/06→			
19.350 FS, FRS, FLS, FLRS-WW	257 kW		05/04→			
19.360 FS, FRS, FLS, FLRS-WW	265 kW		05/04→			
19.390 FS, FRS, FLS, FLRS-WW	287 kW		05/04→			
19.430 FS/M-WW, FLS, FRS, FLRS	316 kW		05/04→			

Manufacturer - Model	Power	Displ.	Year of Constr.	Remark	Part Number	Page
MAN - TGA						04/00→
19.440 FRS, FS/M-WW, FLS, FLRS	324 kW		02/06→	Depth [mm]: 42; + OE 81619016166; L 370 mm; for vehicles with/without air conditioning; Vers. produced by BEHR; W 189 mm	8FH 351 312-551 Heat Exchanger, interior heating	456
19.480 FLS, FRS, FLRS-WW	353 kW		02/06→		Vers. produced by BEHR	9XL 351 341-071 Control Valve, coolant
19.480 FS/M, FRS/M-WW	353 kW		02/06→			
24.480 FPLS, FPLRS	353 kW		07/05→			
24.530 FPLS, FPLRS	390 kW		07/05→			
26.310 FDAC	228 kW		01/04→			
26.310 FDAK	228 kW		01/04→			
26.310 FDAS	228 kW		01/04→			
26.310 FVLC	228 kW		09/03→			
26.320 FDAC	235 kW		04/06→			
26.320 FDAK	235 kW		04/06→			
26.320 FDAS	235 kW		04/06→			
26.350 FDAC	257 kW		02/04→			
26.350 FDAK	257 kW		02/04→			
26.350 FDAS	257 kW		02/04→			
26.350 FDLRC-WW	257 kW		05/04→			
26.350 FDLS, FDLRS, FDLRS/M, FDLRS-WW	257 kW		05/04→			
26.350 FVHLC	257 kW		06/05→			
26.350 FVHLS	257 kW		07/05→			
26.350 FVLC	257 kW		01/04→			
26.350 FVLS, FVLRS	257 kW		07/05→			
26.360 FDAC, FDARC	265 kW		06/04→			
26.360 FDAK, FDARK	265 kW		06/04→			
26.360 FDAS, FDARS	265 kW		06/04→			
26.360 FDHC, FDHLC	265 kW		05/04→			
26.360 FDLRC-WW, FDLRC	265 kW		05/04→			
26.360 FDLS, FDLRS-WW, FNHLS	265 kW		05/04→			
26.360 FVHLC	265 kW		04/06→			
26.360 FVHLS	265 kW		04/06→			
26.360 FVLC	265 kW		04/06→			
26.360 FVLS, FVLRS	265 kW		04/06→			
26.390 FDAC, FDALC	287 kW		01/04→			
26.390 FDAK, FDALK	287 kW		02/04→			
26.390 FDAS, FDALS	287 kW		02/04→			
26.390 FDH-TM	287 kW		06/05→			
26.390 FVLC	287 kW		02/04→			
26.390 FVLS, FVLRS	287 kW		07/05→			
26.400 FDAC, FDALC	294 kW		01/04→			
26.400 FDAK, FDALK	294 kW		01/04→			
26.400 FDAS, FDALS	294 kW		01/04→			
26.400 FDH-TM	294 kW		04/06→			
26.400 FVLC	294 kW		04/06→			
26.400 FVLS, FVLRS	294 kW		04/06→			
26.410 FVLC	301 kW		09/03→			
26.410 FVLS, FVLRS	301 kW		07/05→			
26.430 FDAC, FDALC	316 kW		01/04→			
26.430 FDAK, FDALK	316 kW		01/04→			
26.430 FDAS, FDALS	316 kW		01/04→			
26.430 FDLS, FDLRS-M, FDLRS-WW	316 - 324 kW		02/04→			
26.430 FVL-KO	316 kW		12/00→			
26.430 FVLS, FVLRS	316 kW		07/05→			
26.440 FDAC, FDALC	324 kW		09/05→			
26.440 FDAK, FDALK	324 kW		01/04→			
26.440 FDAS, FDALS	324 kW		01/04→			
26.440 FDLRC-WW, FDLRC-WW	324 kW		02/06→			
26.440 FDS, FDLS, FDLRS-WW, FDLRS-WW	324 kW		02/06→			
26.440 FVL-KO	324 kW		09/05→			
26.440 FVLS, FVLRS	324 kW		09/05→			
26.480 FDAC, FDALC	353 kW		02/06→			
26.480 FDAK, FDALK	353 kW		02/06→			
26.480 FDAS, FDALS	353 kW		02/06→			
26.480 FVL-KO	353 kW		01/06→			
26.530 FDAC, FDALC	390 kW		07/06→			
26.530 FDAK, FDALK	390 kW		09/02→			
26.530 FDAS, FDALS	390 kW		07/06→			
26.540 FNLC, FNLLC, FNLLRC, FNLLW	397 kW		08/06→			
28.310, 28.320 FNLC, FNLLC, FNLL-LE, FNLLR-LE	228 - 235 kW		07/06→			
28.310, 28.320 FNLC, FNLLC, FNLLRC, FNLLR-LE	228 - 235 kW		07/06→			
28.310 FNLC, FNLLC	228 kW		09/02→			
28.310 FNLS, FNLRS	228 kW		06/04→			
28.320 FNLC, FNLLC, FNLRC	235 kW		06/04→			
28.320 FNLS, FNLRS	235 kW		06/04→			

Manufacturer - Model	Power	Displ.	Year of Constr.	Remark	Part Number	Page
MAN - TGA						04/00→
28.350, 28.360 FNLC, FNLLC, FNLL-LE	257 - 265 kW		07/06→	Depth [mm]: 42; + OE 81619016166; L 370 mm; for vehicles with/without air conditioning; Vers. produced by BEHR; W 189 mm	8FH 351 312-551 Heat Exchanger, interior heating	456
28.350, 28.360 FNLC, FNLLC, FNLC, FNLL-LE	257 - 265 kW		06/04→			Vers. produced by BEHR
28.350 FANLC	257 kW		07/06→			
28.350 FANLK	257 kW		07/06→			
28.350 FNLS, FNLRS-WW	257 kW		02/04→			
28.360 FANLC	265 kW		07/06→			
28.360 FANLK	265 kW		07/06→			
28.360 FNLS, FNLRS-WW	265 kW		04/06→			
28.390, 28.400 FNLC, FNLLC, FNLC-WW	287 - 294 kW		06/04→			
28.390 FANLC	287 kW		07/06→			
28.390 FANLK	287 kW		07/06→			
28.390 FNLLC	353 kW		07/06→			
28.390 FNLS, FNLRS	287 kW		05/04→			
28.400 FANLC	294 kW		07/06→			
28.400 FANLK	294 kW		07/06→			
28.400 FNLS, FNLRS	294 kW		04/06→			
28.410 FANLC	301 kW		07/06→			
28.410 FANLK	301 kW		07/06→			
28.410 FNLC, FNLLC	301 kW		09/02→			
28.430, 28.440 FNLC, FNLLC, FNLC-WW	316 - 324 kW		06/04→			
28.430 FANLC	316 kW		07/06→			
28.430 FANLK	316 kW		07/06→			
28.430 FNLS, FNLRS-WW	316 kW		05/04→			
28.440 FANLC	324 kW		07/06→			
28.440 FANLK	324 kW		07/06→			
28.440 FNLS, FNLRS-WW	324 kW		09/05→			
28.480 FANLC	353 kW		07/06→			
28.480 FANLK	353 kW		07/06→			
28.480 FNLC, FNLC-WW, FNLLC	353 kW		02/06→			
28.480 FNLS, FNLRS-WW	353 kW		02/06→			
28.530 FANLC	390 kW		07/06→			
28.530 FANLK	390 kW		07/06→			
28.540 FNLC, FNLLC	397 kW		08/06→			
28.540 FNLS	397 kW		08/06→			
33.350 FDC-TM, FDRC-TM	257 kW		09/07→			
33.360 FDC-TM, FDRC-TM	265 kW		09/07→			
33.390, 33.400 FDC-TM, FDRC-TM	287 - 294 kW		09/07→			
33.440 FDAC, FDHC	324 kW		06/05→			
33.440 FDAK, FDHK	324 kW		06/05→			
33.440 FDAS, FDHS	324 kW		06/05→			
33.440 FDC, FDRC	324 kW		06/05→			
33.440 FDC-TM, FDRC-TM	324 kW		09/07→			
33.440 FDK, FDRK	324 kW		06/05→			
33.440 FDS, FDRS	324 kW		06/05→			
33.460 FDAC-WW	338 kW		09/02→			
33.460 FDAK-WW	338 kW		09/02→			
33.460 FDAS-WW	338 kW		09/02→			
33.480 FDC-TM, FDRC-TM	353 kW		09/07→			
33.530 FDAC, FDALC	390 kW		09/02→			
35.310 FFD-TM	228 kW		11/03→			
35.350 FFDH-TM	257 kW		07/06→			
35.350 FFNLC	257 kW		07/06→			
35.360 FFDHK, FFDHLK	265 kW		07/06→			
35.360 FFDH-TM	265 kW		07/06→			
35.360 FFD-TM	265 kW		11/03→			
35.360 FFNHLC	265 kW		07/06→			
35.360 FFNLC	265 kW		07/06→			
35.390 FDNLC	287 kW		07/06→			
35.390 FFDAK	287 kW		02/04→			
35.390 FFDAK, FFDHK, FFDHLK	287 kW		07/06→			
35.390 FFDH-TM	287 kW		07/06→			
35.400 FDNLC	294 kW		07/06→			
35.400 FFDAK	294 kW		02/04→			
35.400 FFDAK, FFDHK, FFDHLK	294 kW		07/06→			
35.400 FFDH-TM	294 kW		07/06→			
35.400 FFNHLC	294 kW		11/06→			
35.400 FFNLC	294 kW		07/06→			
35.410 FDNLC	301 kW		07/06→			
35.410 FFDAK	301 kW		07/06→			
35.410 FFD-TM	301 kW		11/03→			
35.410 FFNLC	301 kW		07/06→			
35.430 FDNLC	316 kW		07/06→			
35.430 FFDAK, FFDHK, FFDHLK	316 kW		07/06→			
35.430 FFDH-TM	316 kW		07/06→			
35.430 FFNLC	316 kW		07/06→			

Manufacturer - Model	Power	Displ.	Year of Constr.	Remark	Part Number	Page
MAN - TGA						04/00→
35.440 FDNLC	324 kW		07/06→	Depth [mm]: 42; + OE 81619016166; L 370 mm; for vehicles with/without air conditioning; Vers. produced by BEHR; W 189 mm	8FH 351 312-551 Heat Exchanger, interior heating	456
35.440 FFDK, FFDHK, FFDHLK	324 kW		07/06→			
35.440 FFDH-TM	324 kW		07/06→	Vers. produced by BEHR	9XL 351 341-071 Control Valve, coolant	459
35.440 FFNHLC	324 kW		11/06→			
35.440 FFNLC	324 kW		07/06→			
35.460 FFD-TM	338 kW		11/03→			
35.460 FFNLC	338 kW		07/06→			
35.480 FDNLC	353 kW		07/06→			
35.480 FFDK	353 kW		07/06→			
35.480 FFDK, FFDHK, FFDHLK	353 kW		07/06→			
35.480 FFDARS	353 kW		07/06→			
35.480 FFDH-TM	353 kW		07/06→			
35.480 FFD-TM	353 kW		11/03→			
35.480 FFNHLC	353 kW		11/06→			
35.480 FFNLC	353 kW		07/06→			
35.530 FDNLC	390 kW		04/04→			
35.530 FFDK	390 kW		07/06→			
35.530 FFD-TM	390 kW		04/04→			
35.530 FFNLC	390 kW		07/06→			
37.310 FFDC	228 kW		12/04→			
37.310 FFDK	228 kW		12/04→			
37.310 FFD-TM	228 kW		12/04→			
37.360 FFDC	265 kW		12/04→			
37.360 FFDK	265 kW		12/04→			
37.360 FFD-TM	265 kW		12/04→			
37.410 FFDC	301 kW		12/04→			
37.410 FFDK	301 kW		12/04→			
37.410 FFD-TM	301 kW		12/04→			
37.460 FFDC	338 kW		12/04→			
37.460 FFDK	338 kW		12/04→			
37.460 FFD-TM	338 kW		12/04→			
37.480 FFDC	353 kW		12/04→			
37.480 FFDK	353 kW		12/04→			
37.480 FFD-TM	353 kW		12/04→			
37.530 FFDC	390 kW		12/04→			
37.530 FFDK	390 kW		12/04→			
37.530 FFD-TM	390 kW		12/04→			
37.530 FVDS, FVDLS	390 kW		07/06→			
39.390 FVNLC	287 kW		07/06→			
39.400 FVNLC	294 kW		07/06→			
39.430 FVNLC	316 kW		07/06→			
39.440 FVNLC	324 kW		07/06→			
39.480 FVNLC	353 kW		07/06→			
40.410 FDK-WW	301 kW		04/04→			
40.410 FDAS-WW	301 kW		04/04→			
40.440 FDK-WW	324 kW		06/05→			
40.440 FDAS-WW	324 kW		06/05→			
40.440 FDK-WW, FDRK	324 kW		06/05→			
40.440 FDS-WW, FDRS	324 kW		06/05→			
40.460 FDK-WW	338 kW		04/04→			
40.460 FDAS-WW	338 kW		04/04→			
40.480 FDK-WW	353 kW		04/04→			
40.480 FDAS-WW	353 kW		04/04→			
40.480 FDK-WW, FDRK	353 kW		06/05→			
40.480 FDS-WW; FDRS	353 kW		06/05→			
41.350 FFDC-TM, FFDRC-TM	257 kW		09/07→			
41.360 FFD	265 kW		12/08→			
41.360 FFDC-TM, FDRK-TM	265 kW		09/07→			
41.360 FFD-TM	265 kW		12/04→			
41.390 FFDK	287 kW		12/04→			
41.390 FFDC-TM, FDRK-TM	287 kW		09/07→			
41.410 FFDK	301 kW		07/06→			
41.410 FFD-TM	301 kW		12/04→			
41.430 FFDK	316 kW		12/04→			
41.430 FFDK	316 kW		07/06→			
41.430 FFDC-TM, FFDRC	316 kW		09/07→			
41.440 FFD/M	324 kW		12/04→			
41.440 FFDK	324 kW		07/06→			
41.440 FFDC, FFDRC	324 kW		12/04→			
41.440 FFDC-TM, FFDRC-TM	324 kW		09/07→			
41.440 FFDK, FDRK	324 kW		12/04→			
41.460 FFD-TM	338 kW		12/04→			
41.480 FFD	353 kW		12/08→			
41.480 FFDK	353 kW		07/06→			
41.480 FFDARC	353 kW		07/06→			
41.480 FFDC-TM, FFDRC-TM	353 kW		09/07→			
41.480 FFD-TM	353 kW		12/04→			
41.480 FVDS, FVDLS	353 kW		07/06→			
41.530 FFDK	353 kW		07/06→			
41.530 FFDK	390 kW		07/06→			
41.530 FFDC	390 kW		12/04→			

Manufacturer - Model	Power	Displ.	Year of Constr.	Remark	Part Number	Page
MAN - TGA						04/00→
41.530 FFDK	390 kW		12/04→	Depth [mm]: 42; + OE 81619016166; L 370 mm; for vehicles with/without air conditioning; Vers. produced by BEHR; W 189 mm	8FH 351 312-551 Heat Exchanger, interior heating	456
41.530 FFD-TM	390 kW		12/04→			
41.540 FVDLS, FVDLS	397 kW		11/06→			
				Vers. produced by BEHR	9XL 351 341-071 Control Valve, coolant	459
18.410 FLS, FLLS, FLLS/N, FLS-TS, FLRS, FLLRS	301 kW		04/00→	4 pol	5HL 351 029-061 Regulator, passenger compartment fan	456
				Rated Power [W]: 300; 24 V; with integrated regulator; Vers. produced by BEHR	8EW 009 158-151 Interior Blower	452
				Control Valve	9XL 351 029-071 Control Valve, coolant	458
				Vers. produced by BEHR	9XL 351 341-071 Control Valve, coolant	459
18.480 FC, FLC, FLLC, FLLRC, FLLW, FLRC	353 kW		01/06→	Depth [mm]: 42; + OE 81619016166; L 370 mm; for vehicles with/without air conditioning; Vers. produced by BEHR; W 189 mm	8FH 351 312-551 Heat Exchanger, interior heating	456
18.480 FHLC	353 kW		04/06→			
18.480 FHLK, FHLK/M	353 kW		04/06→			
26.280 FNLC, FNLLC, FNLLW	206 kW		11/02→	Control Valve	9XL 351 029-071 Control Valve, coolant	458
26.330 FNLC, FNLLC, FNLLW	240 kW		11/02→	Vers. produced by BEHR	9XL 351 341-071 Control Valve, coolant	459
26.480 FDC, FDC/M, FDLC, FDLRC, FDRC, FNHLC, FVHLC, FDLRC-WW	353 kW		02/06→			
26.480 FDHK, FDHLK	353 kW		02/06→			
26.480 FDS, FDLS, FDLRS, FNHLS, FPHLS, FVHLS	353 kW		02/06→			
33.480 FDAC, FDALC, FDHC, FDHC/M	353 kW		02/06→			
33.480 FDAK, FDALK, FDHK	353 kW		02/06→			
33.480 FDAS, FDALS, FDHS	353 kW		02/06→			
33.480 FDC, FDLC, FDRC, FDC/M	353 kW		01/06→			
33.480 FDK, FDLK, FDRK	353 kW		01/06→			
33.480 FDS, FDRS, FDLS, FDS/M	353 kW		01/06→			
41.480 FFDC, FFDRC, FFDC/M	353 kW		02/06→			
41.480 FFDK, FFDRK	353 kW		02/06→			
41.480 FFD-TM	353 kW		02/06→			
18.480 FHLS, FHLS/M	353 kW		04/06→	Control Valve	9XL 351 029-071 Control Valve, coolant	458
18.480 FK, FK-L, FLK	353 kW		01/06→	Vers. produced by BEHR	9XL 351 341-071 Control Valve, coolant	459
24.480 FNLLC/N, FNLLW/N	353 kW		01/06→			
24.480 FPLS, FPLRS	353 kW		01/06→			
26.480 FDHC, FDHC/M, FDHLC	353 kW		02/06→			
26.480 FDHS, FDHS/M, FDHLS	353 kW		02/06→			
26.480 FDH-TM	353 kW		02/06→			
26.480 FDK, FDLK	353 kW		02/06→			
26.480 FD-TM	353 kW		02/06→			
26.480 FNLC, FNLRC-WW, FNLLC, FNLLRC, FNLLW, FVLC	353 kW		02/06→			
26.480 FNLS, FNLLS, FNLRS, FPLS, FVLS, FVLR	353 kW		02/06→			
26.480 FVHL-KO	353 kW		02/06→			
32.480 FFDRC	353 kW		02/06→			
32.480 FFD-TM, FFDR-TM	353 kW		02/06→			
35.480 FFDC, FFDLC	353 kW		02/04→			
35.480 FFDK, FFDLK	353 kW		02/04→			
35.480 FFD-TM	353 kW		02/04→			
37.480 FFDC	353 kW		02/06→			
37.480 FFDK	353 kW		02/06→			
19.400 FS/M-WW, FRS/M-WW, FLS, FLRS	294 kW		05/04→	Vers. produced by BEHR	9XL 351 341-071 Control Valve, coolant	459
27.440 FDS, FDLS, FDRS, FDLRS	324 kW		10/08→			
35.390 FFNLC	287 kW		07/06→			
41.400 FFD	294 kW		12/08→			
41.400 FFDC-TM, FDRC-TM	294 kW		09/07→			
26.480 FD-TM	353 kW		09/02→	Rated Power [W]: 300; 24 V; with integrated regulator; Vers. produced by BEHR	8EW 009 158-151 Interior Blower	452
				Depth [mm]: 42; + OE 81619016166; L 370 mm; for vehicles with/without air conditioning; Vers. produced by BEHR; W 189 mm	8FH 351 312-551 Heat Exchanger, interior heating	456
				Control Valve	9XL 351 029-071 Control Valve, coolant	458
				Vers. produced by BEHR	9XL 351 341-071 Control Valve, coolant	459

Manufacturer - Model	Power	Displ.	Year of Constr.	Remark	Part Number	Page		
MAN - TGA						04/00→		
35.350 FFDHK, FFDHLK	257 kW		07/06→	Depth [mm]: 42; + OE 81619016166; L 370 mm; for vehicles with/without air conditioning; Vers. produced by BEHR; W 189 mm	8FH 351 312-551 Heat Exchanger, interior heating	456		
					9ML 351 029-111 Resistor, interior blower	457		
					Vers. produced by BEHR 9XL 351 341-071 Control Valve, coolant	459		
40.390, 40.400 FDAK-WW 40.390, 40.400 FDAS-WW 40.430, 40.440 FDAK-WW 40.430, 40.440 FDAS-WW 40.480 FDAK-WW 40.480 FDAS-WW	287 - 294 kW		06/05→	Depth [mm]: 42; + OE 81619016166; L 370 mm; for vehicles with/without air conditioning; Vers. produced by BEHR; W 189 mm	8FH 351 312-551 Heat Exchanger, interior heating	456		
	287 - 294 kW		06/05→		Euro 5; mech.; Stop Valve; + AC; Vers. produced by BEHR 9XL 351 341-051 Control Valve, coolant	458		
	316 - 324 kW		06/05→			Vers. produced by BEHR 9XL 351 341-071 Control Valve, coolant	459	
	316 - 324 kW		06/05→					
	353 kW		06/05→					
353 kW		06/05→						
MAN - TGL						04/05→		
10.180 FC, FRC, FLC, FLRC 10.180 FK, FRK	132 kW		04/05→	4 pol	5HL 351 029-061 Regulator, passenger compartment fan	456		
	132 kW		04/05→		Depth [mm]: 42; + OE 81619016166; L 370 mm; for vehicles with/without air conditioning; Vers. produced by BEHR; W 189 mm 8FH 351 312-551 Heat Exchanger, interior heating	456		
					Control Valve 9XL 351 029-071 Control Valve, coolant	458		
10.210 FC, FRC, FLC, FLRC 10.210 FK, FRK 10.220 FC, FLC, FRC, FLRC 10.220 FK, FRK 10.240 FC, FRC, FLC, FLRC 10.240 FK, FRK 10.250 FC, FLC, FRC, FLRC 10.250 FK, FRK	151 kW		04/05→	Depth [mm]: 42; + OE 81619016166; L 370 mm; for vehicles with/without air conditioning; Vers. produced by BEHR; W 189 mm	8FH 351 312-551 Heat Exchanger, interior heating	456		
	151 kW		04/05→					
	162 kW		04/05→					
	162 kW		04/05→					
	176 kW		04/05→					
	176 kW		04/05→					
	184 kW		04/05→					
12.180 FC, FRC, FLC, FLRC 12.180 FK, FRK 12.210 FC, FRC, FLC, FLRC 12.210 FK, FRK 12.240 FC, FRC, FLC, FLRC 12.240 FK, FRK	132 kW		04/05→	Rated Power [W]: 300; 24 V; with integrated regulator; Vers. produced by BEHR 8EW 009 158-151 Interior Blower	452			
	132 kW		04/05→		Depth [mm]: 42; + OE 81619016166; L 370 mm; for vehicles with/without air conditioning; Vers. produced by BEHR; W 189 mm 8FH 351 312-551 Heat Exchanger, interior heating	456		
	151 kW		04/05→					
	151 kW		04/05→					
	176 kW		04/05→					
	176 kW		04/05→					
12.220 FC, FRC, FLC, FLRC 12.220 FK, FRK 12.250 FC, FLC, FRC, FLRC 12.250 FK, FRK 7.220 FC, FLC, FRC, FLRC 7.250 FC, FLC, FRC, FLRC 8.250 FC, FLC, FLRC, FRC 8.250 FK, FK-L, FRK, FRK-L	162 kW		04/05→	Rated Power [W]: 300; 24 V; with integrated regulator; Vers. produced by BEHR 8EW 009 158-151 Interior Blower	452			
	162 kW		04/05→		Depth [mm]: 42; + OE 81619016166; L 370 mm; for vehicles with/without air conditioning; Vers. produced by BEHR; W 189 mm 8FH 351 312-551 Heat Exchanger, interior heating	456		
	184 kW		04/05→			Vers. produced by BEHR 9XL 351 341-071 Control Valve, coolant	459	
	184 kW		04/05→					
	162 kW		04/05→					
	184 kW		04/05→					
	184 kW		04/05→					
	184 kW		04/05→					
7.150, 8.150 FC, FRC, FLC, FLRC 7.180 FC, FLC, FRC, FLRC 8.240 FC, FRC, FLC, FLRC 8.240 FK, FK-L, FRK, FRK-L	110 kW		04/05→	4 pol	5HL 351 029-061 Regulator, passenger compartment fan	456		
	132 kW		04/05→		Rated Power [W]: 300; 24 V; with integrated regulator; Vers. produced by BEHR 8EW 009 158-151 Interior Blower	452		
	176 kW		04/05→			Depth [mm]: 42; + OE 81619016166; L 370 mm; for vehicles with/without air conditioning; Vers. produced by BEHR; W 189 mm 8FH 351 312-551 Heat Exchanger, interior heating	456	
	176 kW		04/05→				Control Valve 9XL 351 029-071 Control Valve, coolant	458
							Vers. produced by BEHR 9XL 351 341-071 Control Valve, coolant	459
8.150 FK, FRK, FK-L, FRK-L 8.180 FC, FRC, FLC, FLRC 8.180 FK, FK-L, FRK, FRK-L 8.210 FC, FRC, FLC, FLRC 8.210 FK, FK-L, FRK, FRK-L	110 kW		10/06→	4 pol	5HL 351 029-061 Regulator, passenger compartment fan	456		
	132 kW		04/05→		Rated Power [W]: 300; 24 V; with integrated regulator; Vers. produced by BEHR 8EW 009 158-151 Interior Blower	452		
	132 kW		04/05→			Depth [mm]: 42; + OE 81619016166; L 370 mm; for vehicles with/without air conditioning; Vers. produced by BEHR; W 189 mm 8FH 351 312-551 Heat Exchanger, interior heating	456	
	151 kW		04/05→				Control Valve 9XL 351 029-071 Control Valve, coolant	458
	151 kW		04/05→				Euro 5; mech.; Stop Valve; + AC; Vers. produced by BEHR 9XL 351 341-051 Control Valve, coolant	458
							Vers. produced by BEHR 9XL 351 341-071 Control Valve, coolant	459

Manufacturer - Model	Power	Displ.	Year of Constr.	Remark	Part Number	Page		
MAN - TGL						04/05→		
8.220 FC, FLC, FRC, FLRC	162 kW		04/05→	Rated Power [W]: 300; 24 V; with integrated regulator; Vers. produced by BEHR Depth [mm]: 42; + OE 81619016166; L 370 mm; for vehicles with/without air conditioning; Vers. produced by BEHR; W 189 mm Euro 5; mech.; Stop Valve; + AC; Vers. produced by BEHR Vers. produced by BEHR	8EW 009 158-151 Interior Blower	452		
8.220 FK, FRK, FK-L, FRK-L	162 kW		04/05→		8FH 351 312-551 Heat Exchanger, interior heating	456		
					9XL 351 341-051 Control Valve, coolant	458		
					9XL 351 341-071 Control Valve, coolant	459		
MAN - TGM						10/05→		
12.240 FLC, FLLC	176 kW		10/05→	4 pol Depth [mm]: 42; + OE 81619016166; L 370 mm; for vehicles with/without air conditioning; Vers. produced by BEHR; W 189 mm Control Valve	5HL 351 029-061 Regulator, passenger compartment fan	456		
12.280 FC, FLC, FLLC	206 kW		10/05→		8FH 351 312-551 Heat Exchanger, interior heating	456		
					9XL 351 029-071 Control Valve, coolant	458		
12.250 FLC, FLLC	184 kW		10/05→	Depth [mm]: 42; + OE 81619016166; L 370 mm; for vehicles with/without air conditioning; Vers. produced by BEHR; W 189 mm	8FH 351 312-551 Heat Exchanger, interior heating	456		
12.290 FLC, FLLC	213 kW		10/05→					
22.240 FNLLC	176 kW		10/05→					
22.250 FNLLC	184 kW		10/05→					
22.280 FNL, 22.280 FNLLC	206 kW		10/05→					
22.290 FNL, 22.290 FNLLC	213 kW		10/05→					
13.240 FAL, FALC, FALRC,	176 kW		04/06→	4 pol Depth [mm]: 42; + OE 81619016166; L 370 mm; for vehicles with/without air conditioning; Vers. produced by BEHR; W 189 mm Control Valve Vers. produced by BEHR	5HL 351 029-061 Regulator, passenger compartment fan	456		
FAEC, FAERC, FALR								
13.240 FALK, FALRK, FALK-L, FALRK-L	176 kW		04/06→					
13.280 FAEC, FAERC, FAL, FALC, FALRC	206 kW		04/06→					
13.280 FALK, FALRK, FALK-L, FALRK-L	206 kW		04/06→	9XL 351 029-071 Control Valve, coolant	458			
				9XL 351 341-071 Control Valve, coolant	459			
13.250 FAEC, FAERC, FALC, FAL, FALRC, FALR	184 kW		10/05→	Depth [mm]: 42; + OE 81619016166; L 370 mm; for vehicles with/without air conditioning; Vers. produced by BEHR; W 189 mm Vers. produced by BEHR	8FH 351 312-551 Heat Exchanger, interior heating	456		
13.250 FALK, FALRK, FALK-L, FALRK-L	184 kW		10/05→					
13.290 FAEC, FAERC, FAL, FALR, FALC, FALRC	213 kW		10/05→					
13.290 FALK, FALRK, FALK-L, FALRK-L	213 kW		10/05→					
15.240 FC, FLC, FLLC, FLRC, FLLRC	176 kW		10/05→	4 pol Rated Power [W]: 300; 24 V; with integrated regulator; Vers. produced by BEHR Depth [mm]: 42; + OE 81619016166; L 370 mm; for vehicles with/without air conditioning; Vers. produced by BEHR; W 189 mm Control Valve Vers. produced by BEHR	5HL 351 029-061 Regulator, passenger compartment fan	456		
15.280 FC, FLC, FLLC, FLRC, FLLRC	206 kW		10/05→					
18.240 FAC, FARC	176 kW		10/05→					
18.240 FC, FRC, FLC, FLRC, FLLC, FLLRC	176 kW		10/05→					
18.240 FK, FRK, FLK, FK-L, FLRK	176 kW		10/05→					
							9XL 351 029-071 Control Valve, coolant	458
							9XL 351 341-071 Control Valve, coolant	459
15.240 FLK, FLRK	176 kW		10/05→	Rated Power [W]: 300; 24 V; with integrated regulator; Vers. produced by BEHR Depth [mm]: 42; + OE 81619016166; L 370 mm; for vehicles with/without air conditioning; Vers. produced by BEHR; W 189 mm	8EW 009 158-151 Interior Blower	452		
15.250 FC, FLC, FLRC, FLLC, FLLRC	184 kW		10/05→					
15.250 FLK, FLRK	184 kW		10/05→	Vers. produced by BEHR	8FH 351 312-551 Heat Exchanger, interior heating	456		
15.280 FLK, FLRK	206 kW		10/05→					
15.290 FC, FLC, FLRC, FLLC, FLLRC	213 kW		10/05→					
15.290 FLK, FLRK	213 kW		10/05→					
15.330 FC, FLC, FRC, FLRC	240 kW		10/05→					
15.330 FLK, FLRK	240 kW		10/05→					
15.340 FC, FLC, FLRC	250 kW		10/05→					
15.340 FLK, FLRK	250 kW		10/05→					
18.240 FAK, FARK, FAK-L, FARK-L	176 kW		05/06→					
18.250 FAC, FARC	184 kW		10/05→					
18.250 FAK, FARK, FAK-L, FARK-L	184 kW		10/05→					
18.250 FC, FLC, FLLC, FRC, FLRC, FLLRC	184 kW		10/05→					
18.250 FK, FLK, FRK, FLRK	184 kW		10/05→					
18.280 FAC, FARC	206 kW		10/05→					

Manufacturer - Model	Power	Displ.	Year of Constr.	Remark	Part Number	Page
MAN - TGM						10/05→
18.280 FAK, FARK, FAK-L, FARK-L	206 kW		10/05→	Rated Power [W]: 300; 24 V; with integrated regulator; Vers. produced by BEHR	8EW 009 158-151 Interior Blower	452
18.280 FC, FRC, FLC, FLRC, FLLC, FLLRC	206 kW		10/05→	Depth [mm]: 42; + OE 81619016166; L 370 mm; for vehicles with/without air conditioning; Vers. produced by BEHR; W 189 mm	8FH 351 312-551 Heat Exchanger, interior heating	456
18.280 FK, FLK, FRK, FLRK, FK-L	206 kW		10/05→	Vers. produced by BEHR	9XL 351 341-071 Control Valve, coolant	459
18.290 FAC, FARC	213 kW		10/05→			
18.290 FAK, FARK, FAK-L, FARK-L	213 kW		10/05→			
18.290 FC, FLC, FRC, FLRC, FLLC, FLLRC	213 kW		10/05→			
18.290 FK, FLK, FRK, FLRK	213 kW		10/05→			
18.330 FAC, FARC	240 kW		10/05→			
18.330 FAK, FARK, FAK-L, FARK, L	240 kW		10/05→			
18.330 FC, FRC, FLC, FLRC, FLLC, FLLRC	240 kW		10/05→			
18.330 FK, FLK, FRK, FLRK, FK-L	240 kW		10/05→			
18.340 FAC, FARC	250 kW		10/05→			
18.340 FAK, FARK, FAK-L, FARK-L	250 kW		10/05→			
18.340 FC, FLC, FLRC, FLLC, FLLRC, FRC	250 kW		10/05→			
18.340 FK, FRK, FLK, FLRK	250 kW		10/05→			
26.280 FD	206 kW		10/05→			
26.280 FDK-HK, FDRK-HK	206 kW		04/06→			
26.280 FD-TM, FDR-TM	206 kW		04/06→			
26.290 FD, FDR	213 kW		10/05→			
26.290 FDK-HK, FDRK-HK	213 kW		10/05→			
26.290 FD-TM, FDR-TM	213 kW		07/08→			
26.330 FD, FDR	240 kW		10/05→			
26.330 FDK-HK, FDRK-HK	240 kW		04/06→			
26.330 FD-TM, FDR-TM	240 kW		04/06→			
26.330 FNLC, FNLLC, FNLR, FNLLRC, FVL	240 kW		10/05→			
26.340 FD, FDR	250 kW		10/05→			
26.340 FDK-HK, FDRK-HK	250 kW		10/05→			
26.340 FD-TM, FDR-TM	250 kW		07/08→			
26.340 FNLC, FNLLC, FNLR, FNLLRC	250 kW		10/05→			
26.280 FNLC, FNLLC, FNLR, FNLLRC	206 kW		10/05→	Rated Power [W]: 300; 24 V; with integrated regulator; Vers. produced by BEHR	8EW 009 158-151 Interior Blower	452
26.290 FNLC, FNLLC, FNLR, FNLLRC, FVL	213 kW		10/05→	Depth [mm]: 42; + OE 81619016166; L 370 mm; for vehicles with/without air conditioning; Vers. produced by BEHR; W 189 mm	8FH 351 312-551 Heat Exchanger, interior heating	456
				Euro 5; mech.; Stop Valve; + AC; Vers. produced by BEHR	9XL 351 341-051 Control Valve, coolant	458
				Vers. produced by BEHR	9XL 351 341-071 Control Valve, coolant	459
MAN - TGS						09/07→
18.320 FAC, FHLC	235 kW		10/07→	Rated Power [W]: 300; 24 V; with integrated regulator; Vers. produced by BEHR	8EW 009 158-151 Interior Blower	452
18.320 FAK, FAK-L, FALK, FALK-L, FHLK, FHLK/M	235 kW		10/07→	Depth [mm]: 42; + OE 81619016166; L 370 mm; for vehicles with/without air conditioning; Vers. produced by BEHR; W 189 mm	8FH 351 312-551 Heat Exchanger, interior heating	456
18.320 FAS, FHLS, FHLS/M	235 kW		10/07→			
18.320 FC, FLC, FLRC, FLLC, FLLRC, FLLW, FLLW/N	235 kW		10/07→			
18.320 FK, FK-L, FLK, FLK/M	235 kW		10/07→	Euro 5; mech.; Stop Valve; for vehicles without air conditioning; Vers. produced by BEHR	9XL 351 341-041 Control Valve, coolant	458
18.320 FLS, FLS/M, FLS-TS, FLRS, FLRS/M, FLLS, FLLS/N, FLLRS	235 kW		10/07→	Euro 5; mech.; Stop Valve; + AC; Vers. produced by BEHR	9XL 351 341-051 Control Valve, coolant	458
18.360 FAC, FHLC	265 kW		10/07→	Euro 4 (D4); mech.; Stop Valve; for vehicles without air conditioning; Vers. produced by BEHR	9XL 351 341-061 Control Valve, coolant	459
18.360 FAK, FAK-L, FALK, FALK-L, FHLK, FHLK/M	265 kW		10/07→			
18.360 FAS, FALS, FHLS, FHLS/M	265 kW		10/07→			
18.360 FC, FLC, FLRC, FLLC, FLLRC, FLLW, FLLW/N	265 kW		10/07→			
18.360 FK, FK-L, FLK, FLK/M	265 kW		10/07→			
18.360 FLS, FLS/M, FLS-TS, FLRS, FLRS/M, FLLS, FLLS/N, FLLRS	265 kW		10/07→			
18.400 FAC, FHLC	294 kW		10/07→			
18.400 FAK, FAK-L, FALK, FALK-L, FHLK, FHLK/M	294 kW		10/07→			
18.400 FAS, FALS, FHLS, FHLS/M	294 kW		10/07→			
18.400 FC, FLC, FLRC, FLLC, FLLRC, FLLW, FLLW/N	294 kW		10/07→			

Manufacturer - Model	Power	Displ.	Year of Constr.	Remark	Part Number	Page
MAN - TGS						09/07→
18.400 FK, FK-L, FLK, FLK/M	294 kW		10/07→	Rated Power [W]: 300; 24 V; with integrated regulator; Vers. produced by BEHR	8EW 009 158-151	452
18.400 FLS, FLS/M, FLS-TS, FLRS, FLRS/M, FLLS, FLLS/N, FLLRS	294 kW		10/07→		Interior Blower	
18.440 FAC, FHLC	324 kW		10/07→	Depth [mm]: 42; + OE 81619016166; L 370 mm; for vehicles with/without air conditioning; Vers. produced by BEHR; W 189 mm	8FH 351 312-551	456
18.440 FAK, FAK-L, FALK, FALK-L, FHLK, FHLK/M	324 kW		10/07→		Exchanger, interior heating	
18.440 FAS, FALS, FHLS, FHLS/M	324 kW		10/07→	Euro 5; mech.; Stop Valve; for vehicles without air conditioning; Vers. produced by BEHR	9XL 351 341-041	458
18.440 FC, FLC, FLRC, FLLC, FLLRC, FLLW, FLLW/N	324 kW		10/07→	Euro 5; mech.; Stop Valve; + AC; Vers. produced by BEHR	9XL 351 341-051	458
18.440 FK, FK-L, FLK, FLK/M	324 kW		10/07→	Euro 4 (D4); mech.; Stop Valve; for vehicles without air conditioning; Vers. produced by BEHR	9XL 351 341-061	459
18.440 FLS, FLS/M, FLS-TS, FLRS, FLRS/M, FLLS, FLLS/N, FLLRS	324 kW		10/07→		Control Valve, coolant	
18.480 FAC, FHLC	353 kW		10/07→			
18.480 FAK, FAK-L, FALK, FALK-L, FHLK, FHLK/M	353 kW		10/07→			
18.480 FAS, FALS, FHLS	353 kW		10/07→			
18.480 FC, FLC, FLRC, FLLC, FLLRC, FLLW, FLLW/N	353 kW		10/07→			
18.480 FK, FK-L, FLK, FLK/M	353 kW		10/07→			
18.480 FLS, FLS/M, FLS-TS, FLRS, FLRS/M, FLLS, FLLS/N, FLLRS	353 kW		10/07→			
18.540 FAC, FHLC	397 kW		10/07→			
18.540 FAK, FAK-L, FALK, FALK-L, FHLK, FHLK/M	397 kW		10/07→			
18.540 FAS, FALS, FHLS, FHLS/M	397 kW		10/07→			
18.540 FC, FLC, FLRC, FLLC, FLLRC, FLLW, FLLW/N	397 kW		10/07→			
18.540 FK, FK-L, FLK, FLK/M	397 kW		10/07→			
18.540 FLS, FLS/M, FLRS, FLRS/M, FLLS, FLLS/N, FLLRS	397 kW		10/07→			
19.360 FS/M-WW, FLS/M-WW, FRS/M-WW, FLRS/M-WW	265 kW		02/11→			
19.400 FS/M-WW, FLS/M-WW, FRS/M-WW, FLRS/M-WW	294 kW		02/11→			
19.440 FS-WW, FRS-WW, FLS-WW, FLRS-WW	324 kW		02/11→			
19.480 FS/M-WW, FRS/M-WW, FLS/M-WW, FLRS/M-WW	353 kW		02/11→			
24.320 FNLLW/N	235 kW		10/07→			
24.360 FNLLW/N	265 kW		10/07→			
24.360 FPLS, FPLRS	265 kW		10/07→			
24.400 FNLLW/N	294 kW		10/07→			
24.400 FPLS, FPLRS	294 kW		10/07→			
24.440 FNLLW/N	324 kW		10/07→			
24.440 FPLS, FPLRS	324 kW		10/07→			
24.480 FPLS, FPLRS	353 kW		10/07→			
24.540 FPLS, FPLRS	397 kW		10/07→			
26.320 FDAC, FDALC, FDHLC, FDHLC/M	235 kW		07/08→			
26.320 FDAK, FDALK, FDHK, FDHLK	235 kW		07/08→			
26.320 FDAS, FDALS, FDHS, FDHLS, FDHLS/M	235 kW		07/08→			
26.320 FDC, FDRC, FDLC, FDLC/M, FDLRC, FDLRC/M, FNHLC	235 kW		07/08→			
26.320 FDK, FDLK	235 kW		07/08→			
26.320 FDS, FDLs, FDLS/M, FDRS, FDLRS, FDLRS/M, FNHLS	235 kW		07/08→			
26.320 FD-TM	235 kW		07/08→			
26.320 FNLC, FNLRC, FNLLC, FNLLRC, FNLLW, FVLC, FVLC-KO	235 kW		10/07→			
26.320 FNLS, FNLRS, FNLLS, FPLS, FVLS	235 kW		07/08→			
26.320 FVHLC	235 kW		10/07→			
26.360 FDAC, FDALC, FDHLC, FDHLC/M	265 kW		08/08→			
26.360 FDAK, FDALK, FDHK, FDHLK	265 kW		08/08→			
26.360 FDAS, FDALS, FDHS, FDHLS, FDHLS/M	265 kW		08/08→			
26.360 FDC, FDRC, FDLRC/M, FDLC, FDLRC, FNHLC	265 kW		08/08→			
26.360 FDK, FDLK, FDRK	265 kW		08/08→			

Manufacturer - Model	Power	Displ.	Year of Constr.	Remark	Part Number	Page
MAN - TGS						09/07→
26.360 FDS, FDRS, FDRS/M, FDLS, FDLRS, FNHLS	265 kW		08/08→	Rated Power [W]: 300; 24 V; with integrated regulator; Vers. produced by BEHR	8EW 009 158-151 Interior Blower	452
26.360 FD-TM	265 kW		07/08→	Depth [mm]: 42; + OE 81619016166; L 370 mm; for vehicles with/without air conditioning; Vers. produced by BEHR; W 189 mm	8FH 351 312-551 Heat Exchanger, interior heating	456
26.360 FNLC, FNLRC, FNLLC, FNLLRC, FVLC, FVL-KO	265 kW		10/07→			
26.360 FNLLW	265 kW		04/08→	Euro 5; mech.; Stop Valve; for vehicles without air conditioning; Vers. produced by BEHR	9XL 351 341-041 Control Valve, coolant	458
26.360 FNLS, FNLLS, FNLRS, FPLS, FPLRS, FVLS	265 kW		08/08→			
26.360 FPHLS	265 kW		05/08→	Euro 5; mech.; Stop Valve; + AC; Vers. produced by BEHR	9XL 351 341-051 Control Valve, coolant	458
26.360 FVHLC	265 kW		10/07→			
26.360 FVHLS	265 kW		05/08→	Euro 4 (D4); mech.; Stop Valve; for vehicles without air conditioning; Vers. produced by BEHR	9XL 351 341-061 Control Valve, coolant	459
26.400 FDAC, FDALC, FDHLC, FDHLC/M	294 kW		02/09→			
26.400 FDAK, FDALK, FDHK, FDHLK	294 kW		11/07→			
26.400 FDAS, FDALS, FDHS, FDHLS, FDHLS/M	294 kW		09/07→			
26.400 FDC, FDRC, FDC/M, FDLC, FDLC/M, FDLRC, FDLRC/M, FNHLC	294 kW		08/08→			
26.400 FDK, FDLK	294 kW		02/09→			
26.400 FDS, FDS/M, FDLS, FDLs/M, FDRS, FDLRS, FNHLS	294 kW		02/09→			
26.400 FD-TM	294 kW		07/08→			
26.400 FNLC, FNLRC, FNLLC, FNLLRC, FVLC, FVL-KO, FNLLW	294 kW		10/07→			
26.400 FNLS, FNLRS, FNLLS, FNLLRS, FPLS, FPLRS, FVLS	294 kW		02/09→			
26.400 FPHLS	294 kW		05/08→			
26.400 FVHLC	294 kW		10/07→			
26.400 FVHLS	294 kW		05/08→			
26.440 FDAC, FDALC, FDHLC, FDHLC/M	324 kW		02/09→			
26.440 FDAK, FDALK, FDHK, FDHLK	324 kW		11/07→			
26.440 FDAS, FDALS, FDHLS, FDHLS/M	324 kW		02/09→			
26.440 FDC, FDRC, FDC/M, FDLC, FDLC/M, FDLRC, FNHLC	324 kW		02/09→			
26.440 FDK, FDLK	324 kW		07/08→			
26.440 FDS, FDRS, FDS/M, FDLS, FDLRS, FNHLS	324 kW		02/09→			
26.440 FD-TM	324 kW		07/08→			
26.440 FNLC, FNLLC, FNLLW, FNLRC, FNLLRC, FVLC, FVL-KO	324 kW		10/07→			
26.440 FNLS, FNLLS, FNLRS, FPLS, FPLRS, FVLS	324 kW		02/09→			
26.440 FPHLS	324 kW		05/08→			
26.440 FVHLC	324 kW		10/07→			
26.440 FVHLS	324 kW		05/08→			
26.480 FDAC, FDALC, FDHLC, FDHLC/M	353 kW		02/09→			
26.480 FDAK, FDALK, FDHK, FDHLK	353 kW		02/09→			
26.480 FDAS, FDALS, FDHS, FDHLS	353 kW		02/09→			
26.480 FDC, FDC/M, FDLC, FDLC/M, FDRC, FDRC/M, FDLRC, FNHLC	353 kW		02/09→			
26.480 FDK, FDLK	353 kW		07/08→			
26.480 FDS, FDS/M, FDLS, FDLs/M, FDRS, FDLRS, FDRS/M, FNHLS	353 kW		02/09→			
26.480 FNLC, FNLRC, FNLLC, FNLLRC, FNLLW, FVLC, FVL-KO	353 kW		10/07→			
26.480 FNLS, FNLLS, FNLRS, FPLS, FPLRS, FVLS	353 kW		02/09→			
26.480 FPHLS	353 kW		05/08→			
26.480 FVHLC	353 kW		10/07→			
26.480 FVHLS	353 kW		05/08→			
26.540 FDAC, FDALC, FDHLC, FDHLC/M	397 kW		02/09→			
26.540 FDAK, FDALK, FDHLK	397 kW		11/07→			
26.540 FDAS, FDALS, FDHLS	397 kW		02/09→			
26.540 FDC, FDC/M, FDLC, FDLC/M, FDLRC, FDLRC/M, FNHLC	397 kW		02/09→			
26.540 FDK, FDLK	397 kW		02/09→			

Manufacturer - Model	Power	Displ.	Year of Constr.	Remark	Part Number	Page
MAN - TGS						09/07→
26.540 FDS, FDS/M, FDLS, FDRS, FDLRS, FDLS/M, FNHLS	397 kW		02/09→	Rated Power [W]: 300; 24 V; with integrated regulator; Vers. produced by BEHR	8EW 009 158-151 Interior Blower	452
26.540 FNLC, FNLCR, FNLLC, FNLLRC, FNLLW, FVLC, FVL-KO	397 kW		10/07→	Depth [mm]: 42; + OE 81619016166; L 370 mm; for vehicles with/without air conditioning; Vers. produced by BEHR; W 189 mm	8FH 351 312-551 Heat Exchanger, interior heating	456
26.540 FNLS, FNLLS, FPLS, FPLRS, FVLS	397 kW		02/09→	Euro 5; mech.; Stop Valve; for vehicles without air conditioning; Vers. produced by BEHR	9XL 351 341-041 Control Valve, coolant	458
28.320 FNHLC	235 kW		07/08→			
28.320 FNLC	235 kW		07/08→			
28.320 FNLS	235 kW		07/08→	Euro 5; mech.; Stop Valve; + AC; Vers. produced by BEHR	9XL 351 341-051 Control Valve, coolant	458
28.360 FANLC, FNHLC	265 kW		08/08→			
28.360 FANLK	265 kW		08/08→			
28.360 FNLC	265 kW		08/08→			
28.360 FNLS	265 kW		08/08→			
28.400 FANLC, FNHLC	294 kW		08/08→			
28.400 FANLK	294 kW		08/08→			
28.400 FNLC	294 kW		08/08→			
28.400 FNLS	294 kW		08/08→			
28.440 FANLC, FNHLC	324 kW		08/08→			
28.440 FANLK	324 kW		08/08→			
28.440 FNLC	324 kW		08/08→			
28.440 FNLS	324 kW		08/08→			
28.480 FANLC, FNHLC	353 kW		08/08→			
28.480 FANLK	353 kW		08/08→			
28.480 FNLC	353 kW		08/08→			
28.480 FNLS	353 kW		08/08→			
28.540 FNHLC	397 kW		06/08→			
28.540 FNLC	397 kW		02/09→			
28.540 FNLS	397 kW		02/09→			
32.320 FFD-TM	235 kW		02/09→			
32.360 FFDRC	265 kW		08/08→			
32.360 FFD-TM, FFDR-TM	265 kW		10/07→			
32.400 FFDRC	294 kW		08/08→			
32.400 FFD-TM, FFDR-TM	294 kW		10/07→			
32.440 FFDRC	324 kW		08/08→			
32.440 FFD-TM, FFDR-TM	324 kW		10/07→			
32.480 FFD-TM	353 kW		08/08→			
33.360 FDAC, FDALC	265 kW		06/08→			
33.360 FDAK, FDALK, FDHK	265 kW		10/07→			
33.360 FDAS, FDALS, FDHS	265 kW		10/07→			
33.360 FDC, FDLC	265 kW		06/08→			
33.360 FDK, FDLK	265 kW		02/09→			
33.360 FDS, FDLS	265 kW		06/08→			
33.400 FDAC, FDALC	294 kW		07/08→			
33.400 FDAK, FDALK, FDHK	294 kW		07/08→			
33.400 FDAS, FDALS, FDHS	294 kW		07/08→			
33.400 FDC, FDLC	294 kW		06/08→			
33.400 FDK, FDLK	294 kW		07/08→			
33.400 FDS, FDLS	294 kW		07/08→			
33.440 FDAC, FDALC	324 kW		07/08→			
33.440 FDAK, FDALK, FDHK	324 kW		11/07→			
33.440 FDAS, FDALS, FDHS	324 kW		10/07→			
33.440 FDC, FDLC	324 kW		06/08→			
33.440 FDK, FDLK	324 kW		06/08→			
33.440 FDS, FDLS, FDLS/M	324 kW		06/08→			
33.480 FDAC, FDALC	353 kW		08/08→			
33.480 FDAK, FDALK	353 kW		08/08→			
33.480 FDAS, FDALS, FDHS	353 kW		10/07→			
33.480 FDC, FDC/M, FDLC, FDLC/M	353 kW		08/08→			
33.480 FDK, FDLK	353 kW		08/08→			
33.480 FDS, FDLS, FDLS/M	353 kW		08/08→			
33.540 FDAC, FDALC	397 kW		02/09→			
33.540 FDAK, FDALK	397 kW		02/09→			
33.540 FDAS, FDALS	397 kW		02/09→			
33.540 FDC, FDLC, FDLC/M	397 kW		02/09→			
33.540 FDK, FDLK	397 kW		02/09→			
33.540 FDS, FDLS, FDLS/M	397 kW		02/09→			
35.320 FFDAK	235 kW		06/08→			
35.320 FFDAK, FFDHLK	235 kW		06/08→			
35.320 FFDC, FFDLC, FDNLC	235 kW		06/08→			
35.320 FFDK, FFDLK	235 kW		08/08→			
35.320 FFD-TM	235 kW		10/07→			
35.320 FFNLC	235 kW		01/09→			
35.360 FFDAK	265 kW		06/08→			
35.360 FFDAK, FFHDLK	265 kW		06/08→			
35.360 FFDC, FFDLC, FDNLC	265 kW		06/08→			
35.360 FFDK, FFDLK, FFDRK	265 kW		08/08→			
35.360 FFD-TM	265 kW		10/07→			
35.360 FFNLC	265 kW		06/08→			
35.400 FFDAK	294 kW		06/08→			

Manufacturer - Model	Power	Displ.	Year of Constr.	Remark	Part Number	Page
MAN - TGS						09/07→
35.400 FFDK, FFDHLK	294 kW		06/08→	Rated Power [W]: 300; 24 V; with integrated regulator; Vers. produced by BEHR	8EW 009 158-151 Interior Blower	452
35.400 FFDC, FFDLC, FDNLC	294 kW		06/08→			
35.400 FFDK, FFDLK, FFDK	294 kW		08/08→	Depth [mm]: 42; + OE 81619016166; L 370 mm; for vehicles with/without air conditioning; Vers. produced by BEHR; W 189 mm	8FH 351 312-551 Heat	456
35.400 FFD-TM	294 kW		10/07→			
35.400 FFNHLC	294 kW		10/07→	Euro 5; mech.; Stop Valve; for vehicles without air conditioning; Vers. produced by BEHR	9XL 351 341-041 Control Valve, coolant	458
35.400 FFNLC	294 kW		06/08→			
35.440 FDNLC, FFDC, FFDLC, FFNLC	324 kW		06/08→	Euro 5; mech.; Stop Valve; + AC; Vers. produced by BEHR	9XL 351 341-051 Control Valve, coolant	458
35.440 FFDK	324 kW		06/08→			
35.440 FFDK, FFDHLK	324 kW		06/08→	Euro 4 (D4); mech.; Stop Valve; for vehicles without air conditioning; Vers. produced by BEHR	9XL 351 341-061 Control Valve, coolant	459
35.440 FFDK, FFDLK, FFDK	324 kW		08/08→			
35.440 FFD-TM	324 kW		10/07→			
35.440 FFNHLC	324 kW		10/07→			
35.440 FFNLC	324 kW		06/08→			
35.480 FDNLC, FFDC, FFDLC	353 kW		06/08→			
35.480 FFDK	353 kW		06/08→			
35.480 FFDK, FFDHLK	353 kW		06/08→			
35.480 FFDK, FFDLK, FFDK	353 kW		08/08→			
35.480 FFD-TM	353 kW		10/07→			
35.480 FFNHLC	353 kW		10/07→			
35.480 FFNLC	353 kW		06/08→			
35.540 FDNLC, FFDC, FFDLC	397 kW		06/08→			
35.540 FFDK	397 kW		02/09→			
35.540 FFDK, FFDHLK	397 kW		02/09→			
35.540 FFDK, FFDLK, FFDK	397 kW		02/09→			
35.540 FFD-TM	397 kW		10/07→			
35.540 FFNLC	397 kW		02/09→			
40.400 FDAS-WW, FDARS-WW	294 kW		02/11→			
40.440 FDAS-WW, FDARS-WW	324 kW		02/11→			
41.320 FFDK	235 kW		06/08→			
41.360 FFDK	265 kW		06/08→			
41.360 FFDC	265 kW		07/08→			
41.360 FFDK	265 kW		07/08→			
41.360 FFD-TM	265 kW		10/07→			
41.400 FFDC	294 kW		07/08→			
41.400 FFDK	294 kW		07/08→			
41.400 FFD-TM	294 kW		10/07→			
41.440 FFDK	324 kW		06/08→			
41.440 FFDC	324 kW		07/08→			
41.440 FFDK	324 kW		07/08→			
41.440 FFD-TM	324 kW		10/07→			
41.480 FFDK	353 kW		06/08→			
41.480 FFDARC	353 kW		06/08→			
41.480 FFDC	353 kW		07/08→			
41.480 FFDK	353 kW		07/08→			
41.480 FFD-TM	353 kW		10/07→			
41.540 FFDK	397 kW		02/09→			
41.540 FFDC	397 kW		02/09→			
41.540 FFDK	397 kW		02/09→			
41.540 FFD-TM	397 kW		10/07→			
37.320 FFDC	235 kW		07/08→	Rated Power [W]: 300; 24 V; with integrated regulator; Vers. produced by BEHR	8EW 009 158-151 Interior Blower	452
37.320 FFDK	235 kW		07/08→			
37.320 FFD-TM	235 kW		10/07→	Depth [mm]: 42; + OE 81619016166; L 370 mm; for vehicles with/without air conditioning; Vers. produced by BEHR; W 189 mm	8FH 351 312-551 Heat	456
37.360 FFDC	265 kW		07/08→			
37.360 FFDK	265 kW		07/08→			
37.360 FFD-TM	265 kW		10/07→			
37.400 FFDC	294 kW		07/08→			
37.400 FFDK	294 kW		07/08→			
37.400 FFD-TM	294 kW		10/07→			
37.440 FFDC	324 kW		07/08→			
37.440 FFDK	324 kW		07/08→			
37.440 FFD-TM	324 kW		10/07→			
37.480 FFDC	353 kW		07/08→			
37.480 FFDK	353 kW		07/08→			
37.480 FFD-TM	353 kW		10/07→			
37.540 FFDC	397 kW		02/09→			
37.540 FFDK	397 kW		02/09→			
37.540 FFD-TM	397 kW		10/07→			
40.400 FDK-WW, FDARK-WW	294 kW		02/11→			
40.440 FDK-WW, FDARK-WW	324 kW		02/11→			
MAN - TGX						09/07→
18.360 FHLC	265 kW		10/07→	Depth [mm]: 42; + OE 81619016166; L 370 mm; for vehicles with/without air conditioning; Vers. produced by BEHR; W 189 mm	8FH 351 312-551 Heat	456
18.360 FHLS, FHLS/M	265 kW		10/07→			
18.400 FHLC	294 kW		10/07→	Euro 5; mech.; Stop Valve; + AC; Vers. produced by BEHR	9XL 351 341-051 Control Valve, coolant	458
18.400 FHLS, FHLS/M	294 kW		10/07→			
18.440 FHLC	324 kW		10/07→			
18.440 FHLS, FHLS/M	324 kW		10/07→			
18.480 FHLC	353 kW		10/07→			
18.480 FHLS, FHLS/M	353 kW		10/07→			

Manufacturer - Model	Power	Displ.	Year of Constr.	Remark	Part Number	Page
MAN - TGX						09/07→
18.540 FHLC	397 kW		10/07→	Depth [mm]: 42; + OE 81619016166; L 370 mm; for vehicles with/without air conditioning; Vers. produced by BEHR Euro 5; mech.; Stop Valve; + AC; Vers. produced by BEHR	8FH 351 312-551 Heat Exchanger, interior heating	456
18.540 FHLS, FHLS/M	397 kW		10/07→			
18.680 FLS	500 kW		10/07→			
24.360 FNLLW/N	265 kW		10/07→			
24.360 FPLS, FPLRS	265 kW		10/07→			
24.400 FNLLW/N	294 kW		10/07→			
24.400 FPLS, FPLRS	294 kW		10/07→			
24.440 FNLLW/N	324 kW		10/07→			
24.440 FPLRS	324 kW		10/07→			
24.440 FPLS, FPLRS	324 kW		10/07→			
24.480 FNLLW/N	353 kW		10/07→			
24.480 FPLS, FPLRS	353 kW		10/07→			
24.540 FNLLW/N	397 kW		02/09→			
24.540 FPLS, FPLRS	397 kW		10/07→			
18.360 FLC, FLRC, FLLC, FLLRC, FLLW, FLLW/N	265 kW		10/07→	Rated Power [W]: 300; 24 V; with integrated regulator; Vers. produced by BEHR	8EW 009 158-151 Interior Blower	452
				Depth [mm]: 42; + OE 81619016166; L 370 mm; for vehicles with/without air conditioning; Vers. produced by BEHR; W 189 mm	8FH 351 312-551 Heat Exchanger, interior heating	456
				Euro 5; mech.; Stop Valve; for vehicles without air conditioning; Vers. produced by BEHR	9XL 351 341-041 Control Valve, coolant	458
				Euro 5; mech.; Stop Valve; + AC; Vers. produced by BEHR	9XL 351 341-051 Control Valve, coolant	458
				Euro 4 (D4); mech.; Stop Valve; for vehicles without air conditioning; Vers. produced by BEHR	9XL 351 341-061 Control Valve, coolant	459
18.360 FLS, FLS/M, FLRS, FLRS/N, FLLS, FLLS/N, FLLRS, FLLRS/N	265 kW		10/07→	Depth [mm]: 42; + OE 81619016166; L 370 mm; for vehicles with/without air conditioning; Vers. produced by BEHR; W 189 mm	8FH 351 312-551 Heat Exchanger, interior heating	456
18.400 FLC, FLRC, FLLC, FLLRC, FLLW, FLLW/N	294 kW		10/07→	Euro 5; mech.; Stop Valve; for vehicles without air conditioning; Vers. produced by BEHR	9XL 351 341-041 Control Valve, coolant	458
18.400 FLS, FLS/M, FLRS, FLRS/N, FLLS, FLLS/N, FLLRS, FLLRS/N	294 kW		10/07→	Euro 5; mech.; Stop Valve; + AC; Vers. produced by BEHR	9XL 351 341-051 Control Valve, coolant	458
18.440 FLC, FLRC, FLLC, FLLRC, FLLW, FLLW/N	324 kW		10/07→	Euro 4 (D4); mech.; Stop Valve; for vehicles without air conditioning; Vers. produced by BEHR	9XL 351 341-061 Control Valve, coolant	459
18.440 FLRC	324 kW		10/07→			
18.440 FLRS	324 kW		10/07→			
18.440 FLS, FLS/M, FLRS, FLRS/M, FLLS, FLLS/N, FLLRS, FLLRS/	324 kW		10/07→			
18.480 FLC, FLRC, FLLC, FLLRC, FLLW, FLLW/N	353 kW		10/07→			
18.480 FLS, FLS/M, FLRS, FLRS/N, FLLS, FLLS/N, FLLRS, FLLRS/N	353 kW		10/07→			
18.540 FLC, FLRC, FLLC, FLLRC, FLLW, FLLW/N	397 kW		10/07→			
18.540 FLS, FLS/M, FLRS, FLRS/N, FLLS, FLLS/ N, FLLRS, FLLRS/N	397 kW		10/07→			
26.320 FNLS, FNLLS	235 kW		10/07→	Rated Power [W]: 300; 24 V; with integrated regulator; Vers. produced by BEHR	8EW 009 158-151 Interior Blower	452
26.360 FDC, FDLC, FDRC, FDLRC	265 kW		07/08→			
26.360 FDHLC	265 kW		10/07→	Depth [mm]: 42; + OE 81619016166; L 370 mm; for vehicles with/without air conditioning; Vers. produced by BEHR; W 189 mm	8FH 351 312-551 Heat Exchanger, interior heating	456
26.360 FDHLS	265 kW		10/07→			
26.360 FDS, FDLS, FDRS, FDLRS	265 kW		07/08→	Euro 5; mech.; Stop Valve; + AC; Vers. produced by BEHR	9XL 351 341-051 Control Valve, coolant	458
26.360 FNHLC	265 kW		10/07→			
26.360 FNHLS	265 kW		12/07→			
26.360 FNLC, FNLRC, FNLLC, FNLLRC, FNLLW	265 kW		10/07→			
26.360 FNLS, FNLLS, FNLRS, FNLLRS, FPLS, FPLRS, FVLS	265 kW		10/07→			
26.360 FVHLS	265 kW		05/08→			
26.400 FDC, FDLC, FDRC, FDLRC	294 kW		07/08→			
26.400 FDHLC	294 kW		10/07→			
26.400 FDHLS	294 kW		10/07→			
26.400 FDS, FDLS, FDRS, FDLRS	294 kW		07/08→			
26.400 FNHLC	294 kW		12/07→			
26.400 FNHLS	294 kW		12/07→			
26.400 FNLC, FNLRC, FNLLC, FNLLRC, FNLLW	294 kW		10/07→			
26.400 FNLS, FNLLS, FNLRS, FNLLRS, FPLS, FPLRS, FVLS	294 kW		10/07→			
26.400 FPHLS	294 kW		05/08→			
26.400 FVHLS	294 kW		05/08→			

Manufacturer - Model	Power	Displ.	Year of Constr.	Remark	Part Number	Page
MAN - TGX						09/07→
26.440 FDC, FDLC, FDRC, FDLRC	324 kW		07/08→	Rated Power [W]: 300; 24 V; with integrated regulator; Vers. produced by BEHR	8EW 009 158-151	452
26.440 FDHLC	324 kW		09/07→		Interior Blower	
26.440 FDHLS	324 kW		10/07→		Depth [mm]: 42; + OE 81619016166; L 370 mm; for vehicles with/without air conditioning; Vers. produced by BEHR; W 189 mm	8FH 351 312-551
26.440 FDS, FDLS, FDRS, FDLRS	324 kW		07/08→	Euro 5; mech.; Stop Valve; + AC; Vers. produced by BEHR	Exchanger, interior heating	
26.440 FNHLC	324 kW		12/07→		9XL 351 341-051	458
26.440 FNHLS	324 kW		12/07→		Control Valve, coolant	
26.440 FNLC, FNLRC, FNLLC, FNLLRC, FNLLW	324 kW		10/07→			
26.440 FNLS, FNLLS, FNLRS, FNLLRS, FPLS, FPLRS, FVLS	324 kW		10/07→			
26.440 FPHLS	324 kW		05/08→			
26.440 FPLRS	324 kW		07/08→			
26.440 FVHLS	324 kW		05/08→			
26.480 FDC, FDLC, FDRC, FDLRC	353 kW		07/08→			
26.480 FDHLC	353 kW		09/07→			
26.480 FDHLS	353 kW		10/07→			
26.480 FDS, FDLS, FDRS, FDLRS	353 kW		07/08→			
26.480 FNHLC	353 kW		12/07→			
26.480 FNHLS	353 kW		12/07→			
26.480 FNLC, FNLRC, FNLLC, FNLLRC, FNLLW	353 kW		10/07→			
26.480 FNLS, FNLLS, FNLRS, FNLLRS, FPLS, FPLRS, FVLS	353 kW		10/07→			
26.480 FPHLS	353 kW		05/08→			
26.480 FVHLS	353 kW		05/08→			
26.540 FDC, FDLC, FDRC, FDLRC	397 kW		02/09→			
26.540 FDS, FDLS, FDRS, FDLRS	397 kW		02/09→			
26.540 FNLC, FNLRC, FNLLC, FNLLRC, FNLLW	397 kW		10/07→			
26.540 FNLS, FNLRS, FNLLS, FNLLRS, FPLS, FPLRS, FVLS	397 kW		10/07→			
28.360 FNLC	265 kW		10/07→			
28.360 FNLS	265 kW		10/07→			
28.400 FNLC	294 kW		10/07→			
28.400 FNLS	294 kW		10/07→			
28.440 FNLC	324 kW		10/07→			
28.440 FNLS	324 kW		10/07→			
28.480 FNLC	353 kW		10/07→			
28.480 FNLS	353 kW		10/07→			
28.540 FNLC	397 kW		10/07→			
28.540 FNLS	397 kW		02/09→			
33.360 FDC, FDC/M, FDLC	265 kW		10/07→			
33.360 FDS, FDS/M, FDLS, FDLS/M	265 kW		10/07→			
33.400 FDC, FDC/M, FDLC	294 kW		10/07→			
33.400 FDS, FDS/M, FDLS, FDLS/M	294 kW		10/07→			
33.440 FDC, FDC/M, FDLC	324 kW		10/07→			
33.440 FDS, FDS/M, FDLS, FDLS/M	324 kW		10/07→			
33.480 FDC, FDC/M, FDLC	353 kW		10/07→			
33.480 FDS, FDS/M, FDLS, FDLS/M	353 kW		10/07→			
33.540 FDC, FDC/M, FDLC	397 kW		10/07→			
33.540 FDS, FDS/M, FDLS, FDLS/M	397 kW		10/07→			
33.680 FDLC	500 kW		10/07→			
33.680 FDLS	500 kW		10/07→			
35.360 FDNLC	265 kW		06/08→			
35.400 FDNLC	294 kW		06/08→			
35.440 FDNLC	324 kW		06/08→			
35.480 FDNLC	353 kW		06/08→			
35.540 FDNLC	397 kW		06/08→			
41.540 FVDS, FVDLS	397 kW		06/08→			
41.680 FVDS, FVDLS	500 kW		10/07→			

AUDI	HELLA
281 265 303	8FH 351 312-241
DAF	HELLA
129 4099	8EW 009 158-481
129 4099	8EW 009 160-491
MAN	HELLA
81.25601.0026	5HL 351 029-061
81.25601.0027	5HL 351 029-061
81.25907.0249	9ML 351 029-111
81.25907.0260	9ML 351 029-111
81.61930.0036	8EW 009 158-481
81.61930.0036	8EW 009 160-491
81.61930.6036	8EW 009 160-371
81.61930.6089	8EW 009 158-151
81.61930.6098	8EW 009 158-151
81.61980.0044	9XL 351 029-071
81.61980.0046	9XL 351 341-061
81.61980.0048	9XL 351 341-071
81.61980.0049	9XL 351 341-041
81.61980.0050	9XL 351 341-051
81 25907 0186	9ML 351 332-121
81 25907 0187	9ML 351 332-151
81 61901 0056	8FH 351 312-361
81 61901 0064	8FH 351 312-361
81 61901 0065	8FH 351 312-421
81 61901 0067	8FH 351 312-441
81 61901 6166	8FH 351 312-551
81 61920 6023	8FH 351 312-241
81 61930 0042	8EW 009 160-021
81 61930 6037	8EW 009 160-341
81 61930 6064	8EW 009 160-791
81 61930 6083	8EW 009 158-151
81 61930 6086	8EW 009 158-151
MERCEDES-	
BENZ	HELLA
000 821 70 60	9ML 351 332-151
000 830 93 08	8EW 009 158-481
000 830 93 08	8EW 009 160-491
001 830 02 08	8EW 009 160-021
001 830 86 08	8EW 009 160-791
A 000 821 70 60	9ML 351 332-151
A 000 830 93 08	8EW 009 158-481
A 000 830 93 08	8EW 009 160-491
A 001 830 02 08	8EW 009 160-021
A 001 830 86 08	8EW 009 160-791
SISU	HELLA
621 835 100511	9ML 351 332-121
VOLVO	HELLA
8 157 216	8EW 009 160-021
VW	HELLA
281 265 303	8FH 351 312-241

5HL ...

5HL 351 029-061	456
-----------------	-----

8EW ...

8EW 009 158-151	452
8EW 009 158-481	452
8EW 009 160-021	453
8EW 009 160-341	453
8EW 009 160-371	453
8EW 009 160-491	454
8EW 009 160-791	454

8FH ...

8FH 351 312-241	455
8FH 351 312-361	455
8FH 351 312-421	455
8FH 351 312-441	456
8FH 351 312-551	456

9ML ...

9ML 351 029-111	457
9ML 351 332-121	457
9ML 351 332-151	457

9XL ...

9XL 351 029-071	458
9XL 351 341-041	458
9XL 351 341-051	458
9XL 351 341-061	459
9XL 351 341-071	459



Clutch, radiator fan.....	500
Expansion Tank, coolant.....	520
Fan, radiator.....	505
Fan Wheel, engine cooling.....	506
Radiator, engine cooling.....	509

Coupling - Clutch, radiator fan

8MV 376 731-281
BEHR HELLA SERVICE

Visco clutch is only available as 2 separate pieces. Clutch 6400476 and fan 6600588.
Visco-clutch without blower



Diameter [mm]	203
Operating Mode	Thermic
Version	produced by BEHR

8MV 376 757-221
BEHR HELLA SERVICE

Diameter [mm]	290
---------------	-----

8MV 376 757-231
BEHR HELLA SERVICE

Diameter [mm]	270
Number of ports	5

8MV 376 757-251
BEHR HELLA SERVICE

Diameter [mm]	245
Number of ports	2

8MV 376 757-261
BEHR HELLA SERVICE

Climate Zones	for tropical climates
Diameter [mm]	245
Number of ports	2

Coupling - Clutch, radiator fan

8MV 376 757-661
BEHR HELLA SERVICE

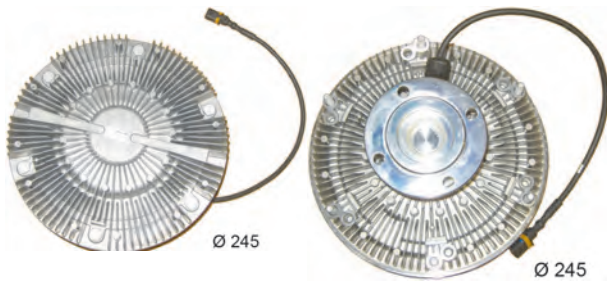

Diameter [mm]	245
Heating / Cooling	Visco Clutch

8MV 376 757-671
BEHR HELLA SERVICE



Diameter [mm]	187
for OE number	51066300067
Heating / Cooling	Visco Clutch

8MV 376 757-681
BEHR HELLA SERVICE



Diameter [mm]	165
for OE number	51066300071
Heating / Cooling	Visco Clutch

Coupling - Clutch, radiator fan

8MV 376 758-471
BEHR HELLA SERVICE

Visco-clutch without blower

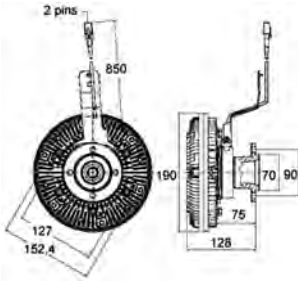

Bore Ø [mm]	152
Depth [mm]	128
Diameter [mm]	190
Heating / Cooling	Visco Clutch
Number of mounting bores	6
Number of Poles	2
Operating Mode	Electric

Accessories



1 x 8MV 376 758-561 Fan Wheel, engine cooling

8MV 376 758-481
BEHR HELLA SERVICE

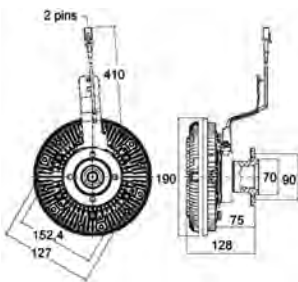

Bore Ø [mm]	1
Depth [mm]	128
Diameter [mm]	190
Heating / Cooling	Visco Clutch
Number of mounting bores	6
Number of Poles	2
Operating Mode	Electric

Accessories



1 x 8MV 376 758-561 Fan Wheel, engine cooling

Coupling - Clutch, radiator fan

8MV 376 758-491
BEHR HELLA SERVICE

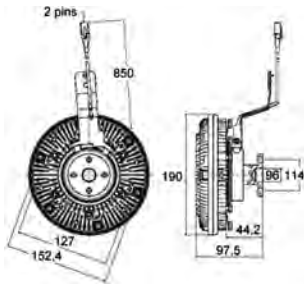

Bore Ø [mm]	152
Depth [mm]	128
Diameter [mm]	190
Heating / Cooling	Visco Clutch
Number of mounting bores	6
Number of Poles	2
Operating Mode	Electric

Accessories



1 x 8MV 376 758-561 Fan Wheel, engine cooling

8MV 376 758-511
BEHR HELLA SERVICE

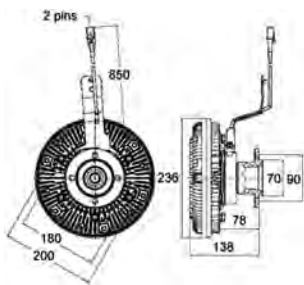

Bore Ø [mm]	200
Depth [mm]	138
Diameter [mm]	236
Heating / Cooling	Visco Clutch
Number of mounting bores	6
Number of Poles	2
Operating Mode	Electric

Accessories



1 x 8MV 376 758-571 Fan Wheel, engine cooling

Coupling - Clutch, radiator fan

8MV 376 758-531
BEHR HELLA SERVICE

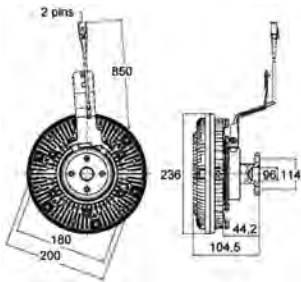

Bore Ø [mm]	200
Depth [mm]	105
Diameter [mm]	236
Heating / Cooling	Visco Clutch
Number of mounting bores	6
Number of Poles	2
Operating Mode	Electric

Accessories



1 x 8MV 376 758-571 Fan Wheel, engine cooling

8MV 376 758-541
BEHR HELLA SERVICE

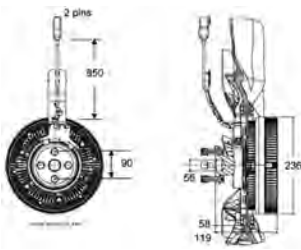

Depth [mm]	119
Diameter [mm]	236
Heating / Cooling	Visco Clutch
Number of mounting bores	6
Number of Poles	2
Operating Mode	Electric

8MV 376 758-551
BEHR HELLA SERVICE

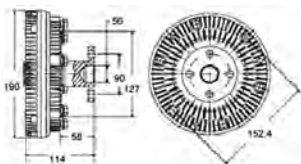

Bore Ø [mm]	152
Depth [mm]	114
Diameter [mm]	190
Heating / Cooling	Visco Clutch

Fan, radiator

8MV 376 728-131
BEHR HELLA SERVICE

Visco-clutch with blower

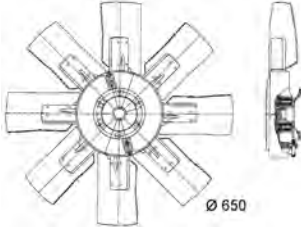

Diameter [mm]	650
Number of Fan Blades	8
Operating Mode	Thermic
Vehicle Trim Level	8060.41
Version	produced by BEHR

8MV 376 757-271
BEHR HELLA SERVICE

Diameter [mm]	753
Number of Fan Blades	9

Fan Wheel, engine cooling

8MV 376 733-131
BEHR HELLA SERVICE

without clutch

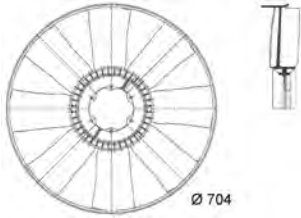

Diameter [mm]	704
Number of Fan Blades	8
Version	produced by BEHR

8MV 376 757-421
BEHR HELLA SERVICE

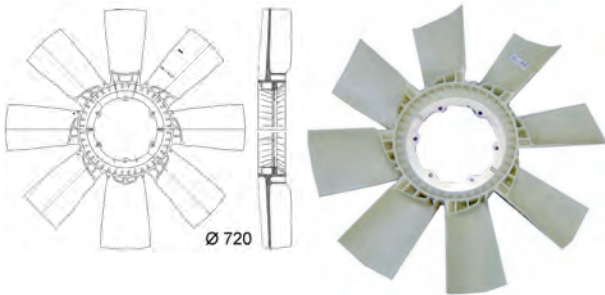

Bore Ø [mm]	9
Diameter [mm]	720
Mounting points diameter [mm]	200
Number of Fan Blades	7
Number of mounting bores	6
Version	produced by BEHR

8MV 376 757-721
BEHR HELLA SERVICE



Diameter [mm]	754
for OE number	51066010275
Number of Fan Blades	9

Fan Wheel, engine cooling

8MV 376 757-731
BEHR HELLA SERVICE

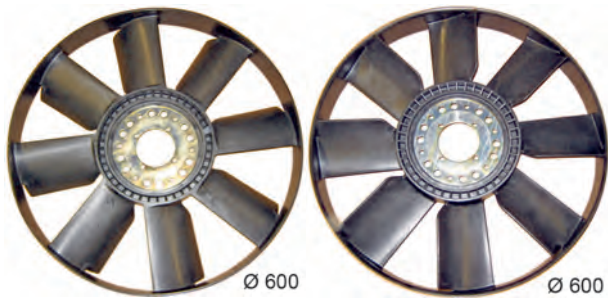

Diameter [mm]	600
for OE number	51066010266
Number of Fan Blades	8

8MV 376 758-561
BEHR HELLA SERVICE

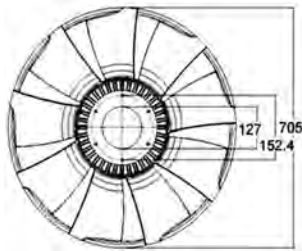

Bore Ø [mm]	152
Diameter 1 [mm]	704
Diameter 2 [mm]	127
Number of Fan Blades	9
Number of mounting bores	6

Accessories

- 
1 x 8MV 376 758-471 Clutch, radiator fan

- 
1 x 8MV 376 758-481 Clutch, radiator fan

- 
1 x 8MV 376 758-491 Clutch, radiator fan

Fan Wheel, engine cooling

8MV 376 758-571
BEHR HELLA SERVICE

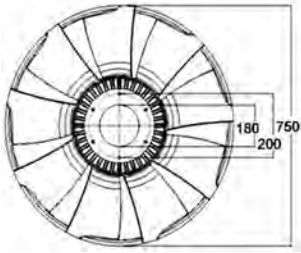

Bore Ø [mm]	200
Diameter 1 [mm]	750
Diameter 2 [mm]	180
Number of Fan Blades	9

Accessories



1 x 8MV 376 758-511 Clutch, radiator fan



1 x 8MV 376 758-531 Clutch, radiator fan

Heat Exchanger - Radiator, engine cooling

8MK 376 709-561
BEHR HELLA SERVICE

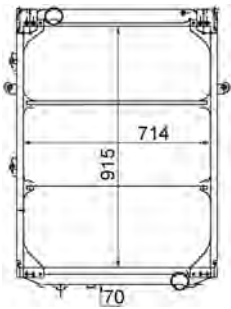

Depth [mm]	47
Length [mm]	915
Width [mm]	704

8MK 376 721-461
BEHR HELLA SERVICE

With reinforced version, Tropic or Trailer function

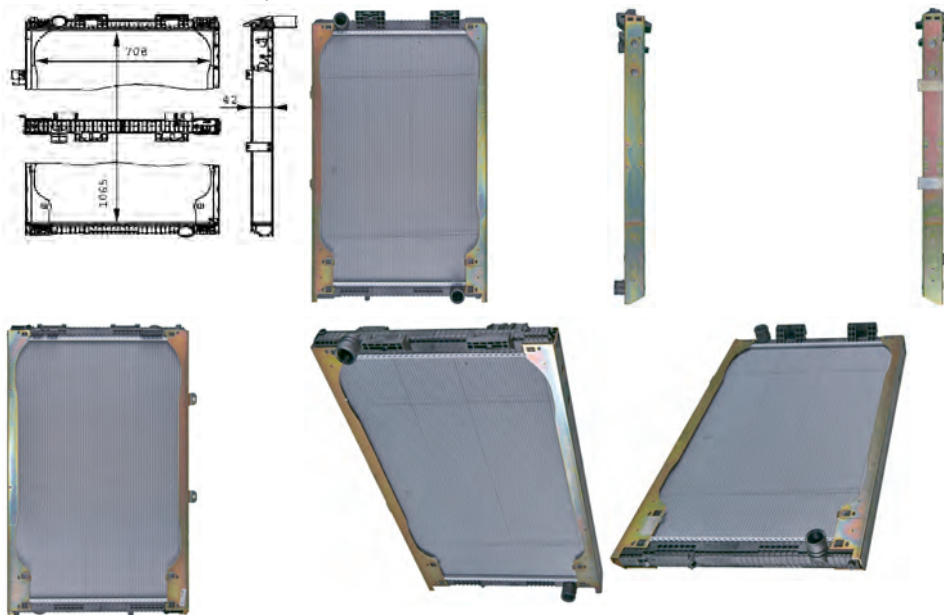

Depth [mm]	42
Length [mm]	1,065
Mounting Bores Distance [mm]	400
Version	produced by BEHR
Width [mm]	708

Spare Parts

- | |
|--|
| 1 x 8MY 376 743-781 Water Tank, radiator |
| 1 x 8MY 376 743-791 Water Tank, radiator |
| 2 x 8MY 376 744-211 Seal, radiator |

Heat Exchanger - Radiator, engine cooling

8MK 376 721-481
BEHR HELLA SERVICE

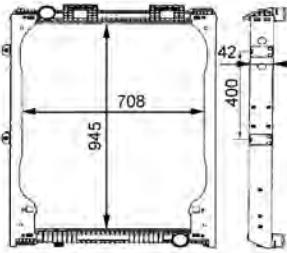

Depth [mm]	40
Length [mm]	945
Mounting Bores Distance [mm]	400
Version	produced by BEHR
Width [mm]	708

Spare Parts

- 1 x 8MY 376 743-781 Water Tank, radiator
- 1 x 8MY 376 743-791 Water Tank, radiator
- 1 x 8MY 376 744-121 Core, radiator
- 2 x 8MY 376 744-211 Seal, radiator

8MK 376 721-681
BEHR HELLA SERVICE

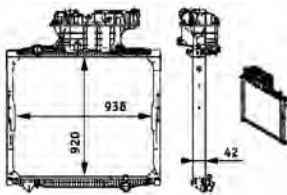

Depth [mm]	42
Length [mm]	920
Version	produced by BEHR
Width [mm]	938

Spare Parts

- 2 x 8MY 376 744-221 Seal, radiator
- 1 x 8MY 376 744-341 Water Tank, radiator
- 1 x 8MY 376 744-351 Core, radiator

Heat Exchanger - Radiator, engine cooling

8MK 376 721-711
BEHR HELLA SERVICE



Depth [mm]	42
Length [mm]	938
Version	produced by BEHR
Width [mm]	765

Spare Parts

2 x 8MY 376 744-221 Seal, radiator
1 x 8MY 376 744-321 Core, radiator
1 x 8MY 376 744-341 Water Tank, radiator

8MK 376 721-761
BEHR HELLA SERVICE

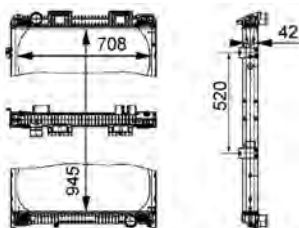

Depth [mm]	42
Length [mm]	945
Mounting Bores Distance [mm]	520
Version	produced by BEHR
Width [mm]	708

Spare Parts

1 x 8MY 376 743-781 Water Tank, radiator
1 x 8MY 376 743-791 Water Tank, radiator
1 x 8MY 376 744-121 Core, radiator
2 x 8MY 376 744-211 Seal, radiator

Heat Exchanger - Radiator, engine cooling

8MK 376 722-241
BEHR HELLA SERVICE

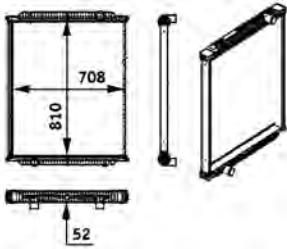

Depth [mm]	52
Length [mm]	810
Supplementary Article/Supplementary Info 2	without frame
Version	produced by BEHR
Width [mm]	708

Spare Parts

- 2 x 8MY 376 744-211 Seal, radiator
- 1 x 8MY 376 744-481 Core, radiator
-  1 x 9NS 376 747-011 Bolt, radiator cap

8MK 376 722-401
BEHR HELLA SERVICE

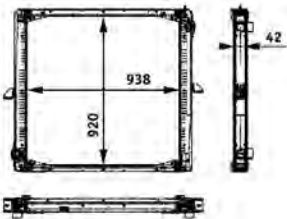

Depth [mm]	42
Length [mm]	938
Version	produced by BEHR
Width [mm]	920

Spare Parts

-  1 x 8MK 376 737-041 Radiator, engine cooling

Heat Exchanger - Radiator, engine cooling

8MK 376 722-411
BEHR HELLA SERVICE

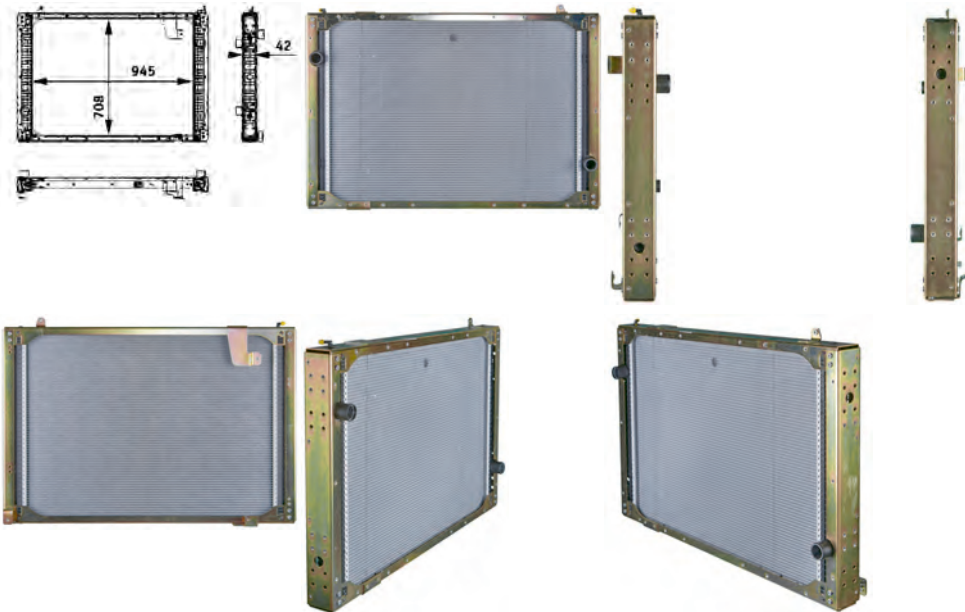

Depth [mm]	42
Length [mm]	945
Version	produced by BEHR
Width [mm]	708

8MK 376 728-661
BEHR HELLA SERVICE

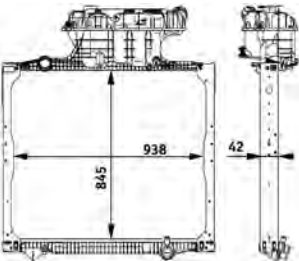

Depth [mm]	42
Length [mm]	845
Version	produced by BEHR
Width [mm]	938

Heat Exchanger - Radiator, engine cooling

8MK 376 728-671
BEHR HELLA SERVICE

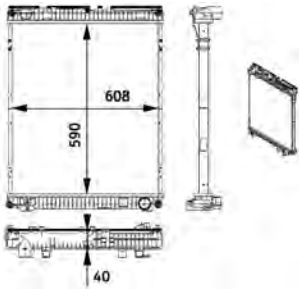

Depth [mm]	40
Length [mm]	590
Version	produced by BEHR
Width [mm]	608

8MK 376 730-621
BEHR HELLA SERVICE

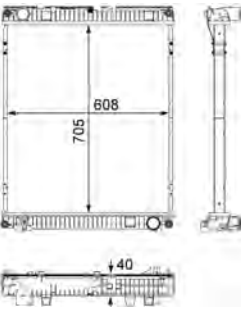

Depth [mm]	40
Length [mm]	705
Version	produced by BEHR
Width [mm]	608

8MK 376 737-041
BEHR HELLA SERVICE

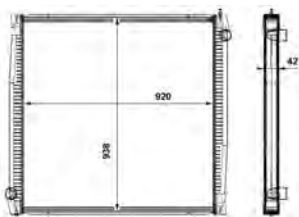

Depth [mm]	42
Length [mm]	938
Supplementary Article/Supplementary Info 2	without frame
Version	produced by BEHR
Width [mm]	920

Heat Exchanger - Radiator, engine cooling

8MK 376 749-821
BEHR HELLA SERVICE

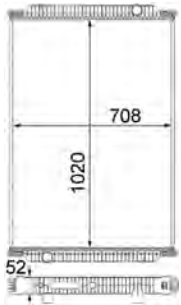

Depth [mm]	52
Length [mm]	1,020
Version	produced by BEHR
Width [mm]	708

8MK 376 755-391
BEHR HELLA SERVICE

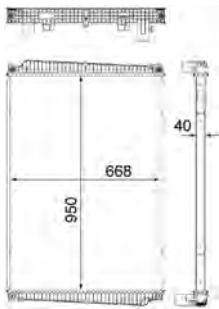

Depth [mm]	40
Length [mm]	668
Version	produced by BEHR
Width [mm]	950

8MK 376 755-401
BEHR HELLA SERVICE



Depth [mm]	40
Length [mm]	668
Version	produced by BEHR
Width [mm]	830

Heat Exchanger - Radiator, engine cooling

8MK 376 755-411
BEHR HELLA SERVICE

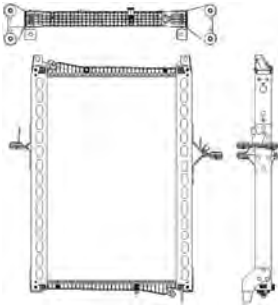

Depth [mm]	40
Length [mm]	668
Version	produced by BEHR
Width [mm]	780

8MK 376 755-421
BEHR HELLA SERVICE

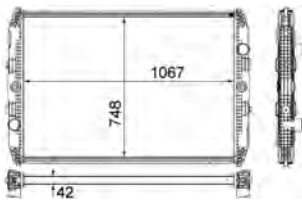

Depth [mm]	42
Length [mm]	1,067
Version	produced by BEHR
Width [mm]	748

8MK 376 755-431
BEHR HELLA SERVICE

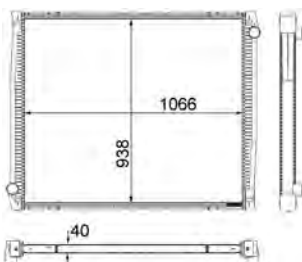

Depth [mm]	40
Length [mm]	1,066
Version	produced by BEHR
Width [mm]	938

Heat Exchanger - Radiator, engine cooling

8MK 376 755-441
BEHR HELLA SERVICE

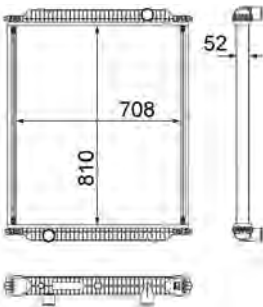

Depth [mm]	52
Length [mm]	810
Version	produced by BEHR
Width [mm]	708

Accessories

1 x 8MY 376 744-481 Core, radiator

8MK 376 755-641
BEHR HELLA SERVICE

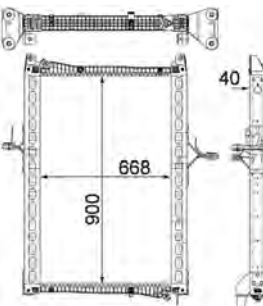

Depth [mm]	40
Length [mm]	668
Version	produced by BEHR
Width [mm]	900

8MK 376 755-651
BEHR HELLA SERVICE

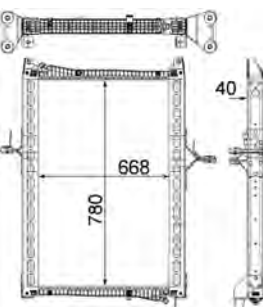

Depth [mm]	40
Length [mm]	668
Version	produced by BEHR
Width [mm]	780

Heat Exchanger - Radiator, engine cooling

8MK 376 756-011
BEHR HELLA SERVICE

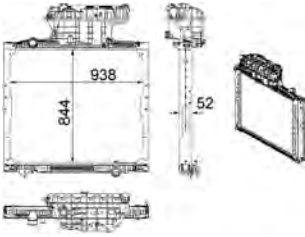

Depth [mm]	52
Length [mm]	938
Version	produced by BEHR
Width [mm]	844

8MK 376 756-021
BEHR HELLA SERVICE

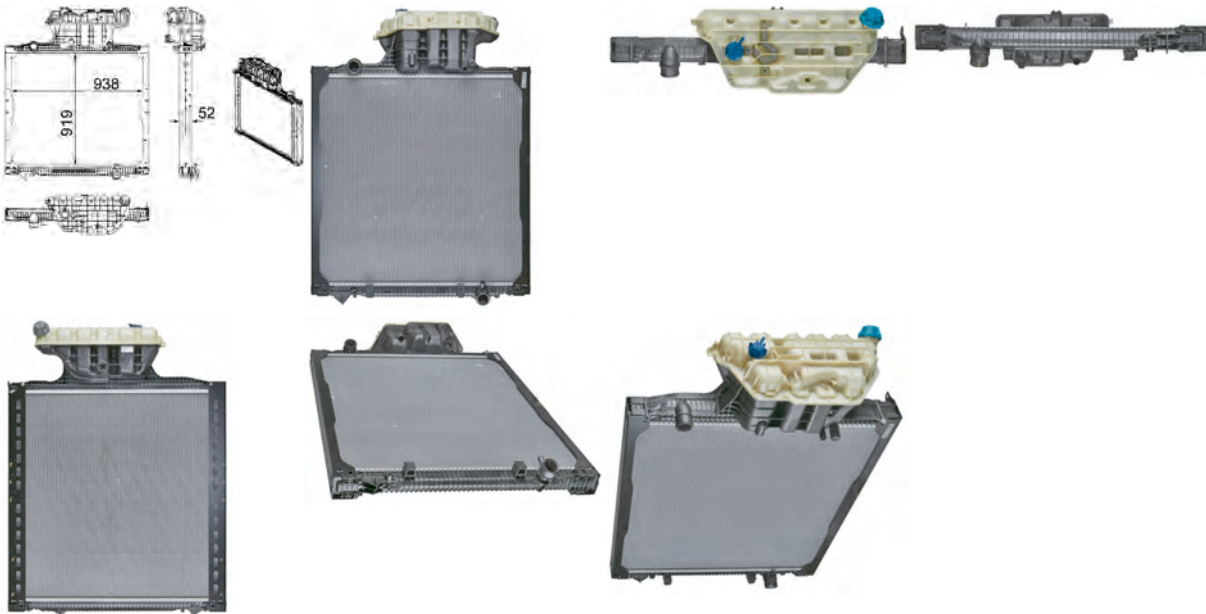

Depth [mm]	52
Length [mm]	938
Version	produced by BEHR
Width [mm]	919

Heat Exchanger - Radiator, engine cooling

8MK 376 774-441
BEHR HELLA SERVICE

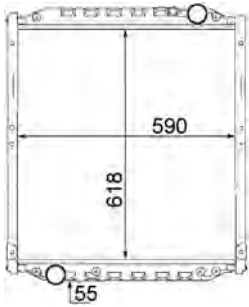

Depth [mm]	58
Length [mm]	590
Width [mm]	618

8MK 376 774-501
BEHR HELLA SERVICE

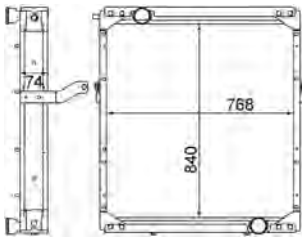

Depth [mm]	74
Length [mm]	840
Width [mm]	768

Tank - Expansion Tank, coolant

8MA 376 705-231
BEHR HELLA SERVICE

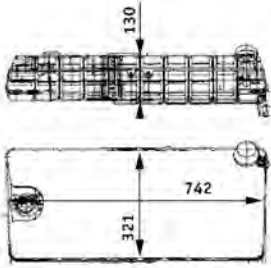

Capacity [Litre]	8,4
Colour	Natural
Depth [mm]	130
Length [mm]	742
Supplementary Article/Supplementary Info 2	with filler cap
Version	<ul style="list-style-type: none"> • ohne Gewindebuchse • produced by BEHR
Width [mm]	321

8MA 376 705-241
BEHR HELLA SERVICE

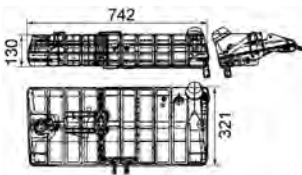

Capacity [Litre]	5,6
Colour	Natural
Depth [mm]	130
Heating / Cooling	with coolant level switch connection
Length [mm]	742
Version	produced by BEHR
Width [mm]	321

Tank - Expansion Tank, coolant

8MA 376 705-251
BEHR HELLA SERVICE

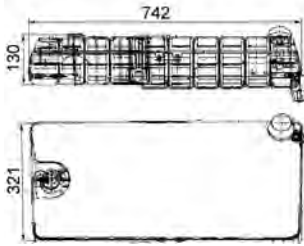

Capacity [Litre]	5,6
Colour	Natural
Depth [mm]	130
Length [mm]	742
Version	<ul style="list-style-type: none"> • ohne Gewindebuchse • produced by BEHR
Width [mm]	321

8MA 376 705-331
BEHR HELLA SERVICE



Capacity [Litre]	8
Colour	Transparent
Depth [mm]	108
Length [mm]	743
Version	produced by BEHR
Width [mm]	321

Tank - Expansion Tank, coolant

8MA 376 705-341
BEHR HELLA SERVICE

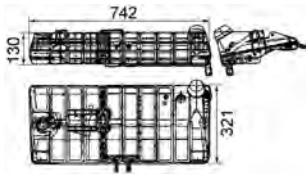

Capacity [Litre]	5,6
Colour	Black
Depth [mm]	130
Heating / Cooling	with coolant level switch connection
Length [mm]	742
Version	produced by BEHR
Width [mm]	321

8MA 376 705-381
BEHR HELLA SERVICE

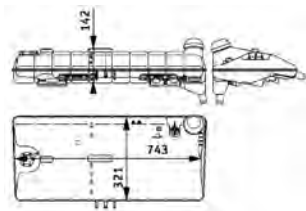

Capacity [Litre]	14
Colour	Black
Depth [mm]	142
Length [mm]	743
Version	produced by BEHR
Width [mm]	321



MAN.....524

Manufacturer - Model	Power	Displ.	Year of Constr.	Remark	Part Number	Page
MAN - Cab-over Trucks					07/86→05/94	
19.322 U, 19.322 UL, 19.322 ULL	235 kW		02/90→05/94	+ OE 81061026098; Capacity [Litre]: 8,4; Natural; Depth [mm]: 130; L 742 mm; with filler cap; Vers. ohne Gewindebuchse / Vers. produced by BEHR; W 321 mm Capacity [Litre]: 5,6; Natural; Depth [mm]: 130; with coolant level switch connection; L 742 mm; Vers. produced by BEHR; W 321 mm Depth [mm]: 47; L 915 mm; W 704 mm	8MA 376 705-231	520
24.322 UNL, 24.322 UNLL	235 kW		02/90→12/90		Expansion Tank, coolant	
24.332 UNL, 24.332 UNLL	243 kW		10/86→02/90			
24.362 UNL, 24.362 UNLL	265 kW		10/86→02/90			
25.322 UNL, 25.322 UNLL	235 kW		09/90→12/92		8MA 376 705-241	520
26.322 UNL, 26.322 UNLL	235 kW		09/90→05/94		Expansion Tank, coolant	
19.332 U, 19.322 UL, 19.322 ULL	243 kW		07/86→02/90	+ OE 81061026098; Capacity [Litre]: 8,4; Natural; Depth [mm]: 130; L 742 mm; with filler cap; Vers. ohne Gewindebuchse / Vers. produced by BEHR; W 321 mm Capacity [Litre]: 5,6; Natural; Depth [mm]: 130; with coolant level switch connection; L 742 mm; Vers. produced by BEHR; W 321 mm	8MA 376 705-231	520
19.362 U, 19.362 UL, 19.362 ULL	265 kW		07/86→01/91		Expansion Tank, coolant	
19.372 U, 19.372 ULL	272 kW		02/90→05/94	+ OE 81061026098; Capacity [Litre]: 8,4; Natural; Depth [mm]: 130; L 742 mm; with filler cap; Vers. ohne Gewindebuchse / Vers. produced by BEHR; W 321 mm Capacity [Litre]: 5,6; Natural; Depth [mm]: 130; with coolant level switch connection; L 742 mm; Vers. produced by BEHR; W 321 mm Capacity [Litre]: 5,6; Black; Depth [mm]: 130; with coolant level switch connection; L 742 mm; Vers. produced by BEHR; W 321 mm Depth [mm]: 47; L 915 mm; W 704 mm	8MA 376 705-231	520
19.422 U, 19.422 ULL	309 kW		02/90→05/94		Expansion Tank, coolant	
24.372 UNL, 24.372 UNLL	272 kW		02/90→12/90			
24.422 UNL, 24.422 UNLL	309 kW		02/90→12/90			
25.372 UNL, 25.372 UNLL	272 kW		09/90→12/92		8MA 376 705-241	520
25.422 UNL, 25.422 UNLL	309 kW		09/90→12/92		Expansion Tank, coolant	
26.372 UNL, 26.372 UNLL	272 kW		09/90→05/94	Capacity [Litre]: 5,6; Black; Depth [mm]: 130; with coolant level switch connection; L 742 mm; Vers. produced by BEHR; W 321 mm Depth [mm]: 47; L 915 mm; W 704 mm	8MA 376 705-341	522
26.422 UNL, 26.422 UNLL	309 kW		09/90→05/94		Expansion Tank, coolant	
					8MK 376 709-561	509
					Radiator, engine cooling	
MAN - E 2000					05/00→	
19.310 FALK	228 kW		05/00→	Capacity [Litre]: 8; Transparent; Depth [mm]: 108; L 743 mm; Vers. produced by BEHR; W 321 mm	8MA 376 705-331	521
19.460 FALK	338 kW		05/00→		Expansion Tank, coolant	
26.460 DFARC	338 kW		05/00→	Capacity [Litre]: 14; Black; Depth [mm]: 142; L 743 mm; Vers. produced by BEHR; W 321 mm	8MA 376 705-381	522
26.460 DFLRS	338 kW		05/00→		Expansion Tank, coolant	
30.460 FANLC	338 kW		05/00→	Depth [mm]: 42; L 1,065 mm; Mounting Bores Distance [mm]: 400; Vers. produced by BEHR; W 708 mm	8MK 376 721-461	509
30.460 FANLK	338 kW		05/00→		Radiator, engine cooling	
30.460 FNLC	338 kW		05/00→	Depth [mm]: 40; L 945 mm; Mounting Bores Distance [mm]: 400; Vers. produced by BEHR; W 708 mm	8MK 376 721-481	510
32.460 VFCL, VFRLC	338 kW		05/00→		Radiator, engine cooling	
32.460 VFNLC	338 kW		05/00→	Depth [mm]: 42; L 945 mm; Mounting Bores Distance [mm]: 520; Vers. produced by BEHR; W 708 mm	8MK 376 721-761	511
33.460 DFK, DFALK	338 kW		04/01→		Radiator, engine cooling	
33.460 DFALC	338 kW		05/00→	Ø 290 mm	8MV 376 757-221	500
33.460 DFALS	338 kW		05/00→		Clutch, radiator fan	
33.460 DFCL	338 kW		05/00→	Ø 753 mm; Number of Fan Blades: 9	8MV 376 757-271	505
33.460 DFLK	338 kW		05/00→		radiator	
33.460 DFLS	338 kW		05/00→	Bore Ø [mm]: 200; Depth [mm]: 138; Ø 236 mm; Number of mounting bores: 6; 2 pol; elec.	8MV 376 758-511	503
					Clutch, radiator fan	
				Depth [mm]: 119; Ø 236 mm; Number of mounting bores: 6; 2 pol; elec.	8MV 376 758-541	504
					Clutch, radiator fan	
				Bore Ø [mm]: 152; Depth [mm]: 114; Ø 190 mm	8MV 376 758-551	504
					Clutch, radiator fan	
				Bore Ø [mm]: 152; Diameter 1 [mm]: 704; Diameter 2 [mm]: 127; Number of Fan Blades: 9; Number of mounting bores: 6	8MV 376 758-561	507
					Wheel, engine cooling	
				Bore Ø [mm]: 200; Diameter 1 [mm]: 750; Diameter 2 [mm]: 180; Number of Fan Blades: 9	8MV 376 758-571	508
					Wheel, engine cooling	
19.310 FALS	228 kW		05/00→	Capacity [Litre]: 8; Transparent; Depth [mm]: 108; L 743 mm; Vers. produced by BEHR; W 321 mm	8MA 376 705-331	521
19.360 FALK	265 kW		05/00→		Expansion Tank, coolant	
19.360 FALS	265 kW		05/00→	Capacity [Litre]: 14; Black; Depth [mm]: 142; L 743 mm; Vers. produced by BEHR; W 321 mm	8MA 376 705-381	522
30.310 FNLC	228 kW		05/00→		Expansion Tank, coolant	
30.360 FANLC	265 kW		05/00→	Depth [mm]: 42; L 1,065 mm; Mounting Bores Distance [mm]: 400; Vers. produced by BEHR; W 708 mm	8MK 376 721-461	509
30.360 FANLK	265 kW		05/00→		Radiator, engine cooling	
30.360 FNLC	265 kW		05/00→	Depth [mm]: 40; L 945 mm; Mounting Bores Distance [mm]: 400; Vers. produced by BEHR; W 708 mm	8MK 376 721-481	510
32.310 VFCL	228 kW		05/00→		Radiator, engine cooling	
32.310 VFNLC	228 kW		05/00→	Depth [mm]: 42; L 945 mm; Mounting Bores Distance [mm]: 520; Vers. produced by BEHR; W 708 mm	8MK 376 721-761	511
32.360 VFCL	265 kW		05/00→		Radiator, engine cooling	
32.360 VFNLC	265 kW		05/00→	Ø 290 mm	8MV 376 757-221	500
33.360 DFALC	265 kW		05/00→		Clutch, radiator fan	
33.360 DFALS	265 kW		04/01→	Ø 753 mm; Number of Fan Blades: 9	8MV 376 757-271	505
33.360 DFCL	265 kW		05/00→		radiator	
33.360 DFLK	265 kW		05/00→			
33.360 DFLS	265 kW		05/00→			

Manufacturer - Model	Power	Displ.	Year of Constr.	Remark	Part Number	Page
MAN - E 2000						05/00→
19.310 FALS	228 kW		05/00→	Bore Ø [mm]: 152; Depth [mm]: 128; Ø 190 mm; Number of mounting bores: 6; 2 pol; elec.	8MV 376 758-471 Clutch, radiator fan	502
19.360 FALK	265 kW		05/00→			
19.360 FALS	265 kW		05/00→	Bore Ø [mm]: 200; Depth [mm]: 138; Ø 236 mm; Number of mounting bores: 6; 2 pol; elec.	8MV 376 758-511 Clutch, radiator fan	503
30.310 FNLC	228 kW		05/00→			
30.360 FANLC	265 kW		05/00→	Depth [mm]: 119; Ø 236 mm; Number of mounting bores: 6; 2 pol; elec.	8MV 376 758-541 Clutch, radiator fan	504
30.360 FANLK	265 kW		05/00→			
30.360 FNLC	265 kW		05/00→	Bore Ø [mm]: 152; Depth [mm]: 114; Ø 190 mm	8MV 376 758-551 Clutch, radiator fan	504
32.310 VFCL	228 kW		05/00→			
32.310 VFNLC	228 kW		05/00→			
32.360 VFCL	265 kW		05/00→	Bore Ø [mm]: 152; Diameter 1 [mm]: 704; Diameter 2 [mm]: 127; Number of Fan Blades: 9; Number of mounting bores: 6	8MV 376 758-561 Fan Wheel, engine cooling	507
32.360 VFNLC	265 kW		05/00→			
33.360 DFALC	265 kW		05/00→	Bore Ø [mm]: 200; Diameter 1 [mm]: 750; Diameter 2 [mm]: 180; Number of Fan Blades: 9	8MV 376 758-571 Fan Wheel, engine cooling	508
33.360 DFALS	265 kW		04/01→			
33.360 DFCL	265 kW		05/00→			
33.360 DFLK	265 kW		05/00→			
33.360 DFSL	265 kW		05/00→			
19.310 FLK	228 kW		05/00→	Capacity [Litre]: 8; Transparent; Depth [mm]: 108; L 743 mm; Vers. produced by BEHR; W 321 mm	8MA 376 705-331 Expansion Tank, coolant	521
19.310 FLS	228 kW		05/00→			
19.360 FLK	265 kW		05/00→	Capacity [Litre]: 14; Black; Depth [mm]: 142; L 743 mm; Vers. produced by BEHR; W 321 mm	8MA 376 705-381 Expansion Tank, coolant	522
19.360 FLS	265 kW		05/00→	Depth [mm]: 42; L 1,065 mm; Mounting Bores Distance [mm]: 400; Vers. produced by BEHR; W 708 mm	8MK 376 721-461 Radiator, engine cooling	509
				Depth [mm]: 42; L 945 mm; Mounting Bores Distance [mm]: 520; Vers. produced by BEHR; W 708 mm	8MK 376 721-761 Radiator, engine cooling	511
				Ø 290 mm	8MV 376 757-221 Clutch, radiator fan	500
				Ø 753 mm; Number of Fan Blades: 9	8MV 376 757-271 Fan, radiator	505
				Bore Ø [mm]: 152; Depth [mm]: 128; Ø 190 mm; Number of mounting bores: 6; 2 pol; elec.	8MV 376 758-471 Clutch, radiator fan	502
				Bore Ø [mm]: 200; Depth [mm]: 138; Ø 236 mm; Number of mounting bores: 6; 2 pol; elec.	8MV 376 758-511 Clutch, radiator fan	503
				Depth [mm]: 119; Ø 236 mm; Number of mounting bores: 6; 2 pol; elec.	8MV 376 758-541 Clutch, radiator fan	504
				Bore Ø [mm]: 152; Depth [mm]: 114; Ø 190 mm	8MV 376 758-551 Clutch, radiator fan	504
				Bore Ø [mm]: 152; Diameter 1 [mm]: 704; Diameter 2 [mm]: 127; Number of Fan Blades: 9; Number of mounting bores: 6	8MV 376 758-561 Fan Wheel, engine cooling	507
				Bore Ø [mm]: 200; Diameter 1 [mm]: 750; Diameter 2 [mm]: 180; Number of Fan Blades: 9	8MV 376 758-571 Fan Wheel, engine cooling	508
19.410 FALK	301 kW		05/00→	Capacity [Litre]: 8; Transparent; Depth [mm]: 108; L 743 mm; Vers. produced by BEHR; W 321 mm	8MA 376 705-331 Expansion Tank, coolant	521
19.410 FALS	301 kW		05/00→			
26.410 DFARC	301 kW		05/00→	Capacity [Litre]: 14; Black; Depth [mm]: 142; L 743 mm; Vers. produced by BEHR; W 321 mm	8MA 376 705-381 Expansion Tank, coolant	522
26.410 DFRC, FAVLC	301 kW		05/00→	Depth [mm]: 42; L 1,065 mm; Mounting Bores Distance [mm]: 400; Vers. produced by BEHR; W 708 mm	8MK 376 721-461 Radiator, engine cooling	509
30.410 FNLC	301 kW		05/00→			
30.410 FNLC	301 kW		05/00→	Depth [mm]: 40; L 945 mm; Mounting Bores Distance [mm]: 400; Vers. produced by BEHR; W 708 mm	8MK 376 721-481 Radiator, engine cooling	510
32.410 VFARK	301 kW		05/00→			
32.410 VFCL, VFRC, VFLRC	301 kW		05/00→			
32.410 VFNLC	301 kW		05/00→			
33.410 DFALC	301 kW		05/00→	Depth [mm]: 42; L 945 mm; Mounting Bores Distance [mm]: 520; Vers. produced by BEHR; W 708 mm	8MK 376 721-761 Radiator, engine cooling	511
33.410 DFALS	301 kW		04/01→			
33.410 DFLK	301 kW		05/00→			
33.410 DFSL	301 kW		05/00→			
19.410 FLK	301 kW		05/00→	Capacity [Litre]: 8; Transparent; Depth [mm]: 108; L 743 mm; Vers. produced by BEHR; W 321 mm	8MA 376 705-331 Expansion Tank, coolant	521
19.410 FLS	301 kW		05/00→			
				Capacity [Litre]: 14; Black; Depth [mm]: 142; L 743 mm; Vers. produced by BEHR; W 321 mm	8MA 376 705-381 Expansion Tank, coolant	522
				Depth [mm]: 42; L 1,065 mm; Mounting Bores Distance [mm]: 400; Vers. produced by BEHR; W 708 mm	8MK 376 721-461 Radiator, engine cooling	509

Manufacturer - Model	Power	Displ.	Year of Constr.	Remark	Part Number	Page
MAN - E 2000						05/00→
19.410 FLK	301 kW		05/00→	Depth [mm]: 42; L 945 mm; Mounting Bores	8MK 376 721-761	511
19.410 FLS	301 kW		05/00→	Distance [mm]: 520; Vers. produced by BEHR; W 708 mm	Radiator, engine cooling	
				Ø 290 mm	8MV 376 757-221	500
					Clutch, radiator fan	
				Ø 753 mm; Number of Fan Blades: 9	8MV 376 757-271	505
					Fan, radiator	
				Bore Ø [mm]: 152; Depth [mm]: 128; Ø 190 mm; Number of mounting bores: 6; 2 pol; elec.	8MV 376 758-471	502
					Clutch, radiator fan	
				Bore Ø [mm]: 152; Depth [mm]: 114; Ø 190 mm	8MV 376 758-551	504
					Clutch, radiator fan	
				Bore Ø [mm]: 152; Diameter 1 [mm]: 704; Diameter 2 [mm]: 127; Number of Fan Blades: 9; Number of mounting bores: 6	8MV 376 758-561	507
					Fan Wheel, engine cooling	
				Bore Ø [mm]: 200; Diameter 1 [mm]: 750; Diameter 2 [mm]: 180; Number of Fan Blades: 9	8MV 376 758-571	508
					Fan Wheel, engine cooling	
19.460 FALS	338 kW		05/00→	Capacity [Litre]: 8; Transparent; Depth [mm]: 108; L 743 mm; Vers. produced by BEHR; W 321 mm	8MA 376 705-331	521
26.460 FAVLC	338 kW		05/00→		Expansion Tank, coolant	
26.460 FAVLK	338 kW		05/00→			
28.460 FANLC	338 kW		05/00→	Capacity [Litre]: 14; Black; Depth [mm]: 142; L 743 mm; Vers. produced by BEHR; W 321 mm	8MA 376 705-381	522
28.460 FANLK	338 kW		05/00→		Expansion Tank, coolant	
28.460 FNLC	338 kW		05/00→	Depth [mm]: 40; L 945 mm; Mounting Bores	8MK 376 721-481	510
35.460 FVNLC	338 kW		05/00→	Distance [mm]: 400; Vers. produced by BEHR; W 708 mm	Radiator, engine cooling	
35.460 VFAK	338 kW		05/00→	Depth [mm]: 42; L 945 mm; Mounting Bores	8MK 376 721-761	511
41.460 DFVS, DFVLS	338 kW		06/00→	Distance [mm]: 520; Vers. produced by BEHR; W 708 mm	Radiator, engine cooling	
41.460 VFAK	338 kW		05/00→			
50.460 VFAK	338 kW		05/00→	Ø 290 mm	8MV 376 757-221	500
50.460 VFAVK, VFAV-G	338 kW		03/01→		Clutch, radiator fan	
50.460 VFK	338 kW		05/00→	Ø 753 mm; Number of Fan Blades: 9	8MV 376 757-271	505
					Fan, radiator	
				Bore Ø [mm]: 200; Depth [mm]: 138; Ø 236 mm; Number of mounting bores: 6; 2 pol; elec.	8MV 376 758-511	503
					Clutch, radiator fan	
				Depth [mm]: 119; Ø 236 mm; Number of mounting bores: 6; 2 pol; elec.	8MV 376 758-541	504
					Clutch, radiator fan	
				Bore Ø [mm]: 152; Depth [mm]: 114; Ø 190 mm	8MV 376 758-551	504
					Clutch, radiator fan	
				Bore Ø [mm]: 152; Diameter 1 [mm]: 704; Diameter 2 [mm]: 127; Number of Fan Blades: 9; Number of mounting bores: 6	8MV 376 758-561	507
					Fan Wheel, engine cooling	
				Bore Ø [mm]: 200; Diameter 1 [mm]: 750; Diameter 2 [mm]: 180; Number of Fan Blades: 9	8MV 376 758-571	508
					Fan Wheel, engine cooling	
19.460 FLK	338 kW		05/00→	Capacity [Litre]: 8; Transparent; Depth [mm]: 108; L 743 mm; Vers. produced by BEHR; W 321 mm	8MA 376 705-331	521
19.460 FLS	338 kW		05/00→		Expansion Tank, coolant	
				Capacity [Litre]: 14; Black; Depth [mm]: 142; L 743 mm; Vers. produced by BEHR; W 321 mm	8MA 376 705-381	522
					Expansion Tank, coolant	
				Depth [mm]: 42; L 1,065 mm; Mounting Bores	8MK 376 721-461	509
				Distance [mm]: 400; Vers. produced by BEHR; W 708 mm	Radiator, engine cooling	
				Depth [mm]: 42; L 945 mm; Mounting Bores	8MK 376 721-761	511
				Distance [mm]: 520; Vers. produced by BEHR; W 708 mm	Radiator, engine cooling	
				Ø 290 mm	8MV 376 757-221	500
					Clutch, radiator fan	
				Ø 753 mm; Number of Fan Blades: 9	8MV 376 757-271	505
					Fan, radiator	
				Bore Ø [mm]: 200; Depth [mm]: 138; Ø 236 mm; Number of mounting bores: 6; 2 pol; elec.	8MV 376 758-511	503
					Clutch, radiator fan	
				Depth [mm]: 119; Ø 236 mm; Number of mounting bores: 6; 2 pol; elec.	8MV 376 758-541	504
					Clutch, radiator fan	
				Bore Ø [mm]: 152; Depth [mm]: 114; Ø 190 mm	8MV 376 758-551	504
					Clutch, radiator fan	
				Bore Ø [mm]: 152; Diameter 1 [mm]: 704; Diameter 2 [mm]: 127; Number of Fan Blades: 9; Number of mounting bores: 6	8MV 376 758-561	507
					Fan Wheel, engine cooling	
				Bore Ø [mm]: 200; Diameter 1 [mm]: 750; Diameter 2 [mm]: 180; Number of Fan Blades: 9	8MV 376 758-571	508
					Fan Wheel, engine cooling	
26.310 FAVLC	228 kW		05/00→	Capacity [Litre]: 8; Transparent; Depth [mm]: 108; L 743 mm; Vers. produced by BEHR; W 321 mm	8MA 376 705-331	521
26.310 FAVLK	228 kW		05/00→		Expansion Tank, coolant	
26.360 FAVLC	265 kW		05/00→			
26.360 FAVLK	265 kW		05/00→	Capacity [Litre]: 14; Black; Depth [mm]: 142; L 743 mm; Vers. produced by BEHR; W 321 mm	8MA 376 705-381	522
28.310 FNLC	228 kW		05/00→		Expansion Tank, coolant	
28.360 FANLC	265 kW		05/00→	Depth [mm]: 40; L 945 mm; Mounting Bores	8MK 376 721-481	510
28.360 FANLK	265 kW		05/00→	Distance [mm]: 400; Vers. produced by BEHR; W 708 mm	Radiator, engine cooling	
28.360 FNALC	265 kW		05/00→	Depth [mm]: 42; L 945 mm; Mounting Bores	8MK 376 721-761	511
28.360 FNLC	265 kW		05/00→	Distance [mm]: 520; Vers. produced by BEHR; W 708 mm	Radiator, engine cooling	
33.360 DFAK, DFALK	265 kW		05/00→			
35.360 VFAK	265 kW		05/00→			

Manufacturer - Model	Power	Displ.	Year of Constr.	Remark	Part Number	Page
MAN - E 2000						05/00→
41.360 VFAK	265 kW		05/00→	Ø 290 mm	8MV 376 757-221 Clutch, radiator fan	500
				Ø 753 mm; Number of Fan Blades: 9	8MV 376 757-271 Fan, radiator	505
				Bore Ø [mm]: 152; Depth [mm]: 128; Ø 190 mm; Number of mounting bores: 6; 2 pol; elec.	8MV 376 758-471 Clutch, radiator fan	502
				Bore Ø [mm]: 200; Depth [mm]: 138; Ø 236 mm; Number of mounting bores: 6; 2 pol; elec.	8MV 376 758-511 Clutch, radiator fan	503
				Depth [mm]: 119; Ø 236 mm; Number of mounting bores: 6; 2 pol; elec.	8MV 376 758-541 Clutch, radiator fan	504
				Bore Ø [mm]: 152; Depth [mm]: 114; Ø 190 mm	8MV 376 758-551 Clutch, radiator fan	504
				Bore Ø [mm]: 152; Diameter 1 [mm]: 704; Diameter 2 [mm]: 127; Number of Fan Blades: 9; Number of mounting bores: 6	8MV 376 758-561 Fan Wheel, engine cooling	507
				Bore Ø [mm]: 200; Diameter 1 [mm]: 750; Diameter 2 [mm]: 180; Number of Fan Blades: 9	8MV 376 758-571 Fan Wheel, engine cooling	508
26.410 FAVLK 28.410 FANLC 28.410 FANLK 28.410 FNLC 33.410 DFAK, DFALK 35.410 FVNLC 35.410 VFAK 41.410 VFAK 50.410 VFAK 50.410 VFAVK, VFAV-G 50.410 VFK	301 kW		05/00→	Capacity [Litre]: 8; Transparent; Depth [mm]: 108; L 743 mm; Vers. produced by BEHR; W 321 mm	8MA 376 705-331 Expansion Tank, coolant	521
				Capacity [Litre]: 14; Black; Depth [mm]: 142; L 743 mm; Vers. produced by BEHR; W 321 mm	8MA 376 705-381 Expansion Tank, coolant	522
				Depth [mm]: 40; L 945 mm; Mounting Bores Distance [mm]: 400; Vers. produced by BEHR; W 708 mm	8MK 376 721-481 Radiator, engine cooling	510
				Depth [mm]: 42; L 945 mm; Mounting Bores Distance [mm]: 520; Vers. produced by BEHR; W 708 mm	8MK 376 721-761 Radiator, engine cooling	511
				Ø 290 mm	8MV 376 757-221 Clutch, radiator fan	500
				Ø 753 mm; Number of Fan Blades: 9	8MV 376 757-271 Fan, radiator	505
				Bore Ø [mm]: 152; Depth [mm]: 128; Ø 190 mm; Number of mounting bores: 6; 2 pol; elec.	8MV 376 758-471 Clutch, radiator fan	502
				Bore Ø [mm]: 152; Depth [mm]: 114; Ø 190 mm	8MV 376 758-551 Clutch, radiator fan	504
				Bore Ø [mm]: 152; Diameter 1 [mm]: 704; Diameter 2 [mm]: 127; Number of Fan Blades: 9; Number of mounting bores: 6	8MV 376 758-561 Fan Wheel, engine cooling	507
				Bore Ø [mm]: 200; Diameter 1 [mm]: 750; Diameter 2 [mm]: 180; Number of Fan Blades: 9	8MV 376 758-571 Fan Wheel, engine cooling	508
				Capacity [Litre]: 8; Transparent; Depth [mm]: 108; L 743 mm; Vers. produced by BEHR; W 321 mm	8MA 376 705-331 Expansion Tank, coolant	521
				Capacity [Litre]: 14; Black; Depth [mm]: 142; L 743 mm; Vers. produced by BEHR; W 321 mm	8MA 376 705-381 Expansion Tank, coolant	522
				Depth [mm]: 40; L 945 mm; Mounting Bores Distance [mm]: 400; Vers. produced by BEHR; W 708 mm	8MK 376 721-481 Radiator, engine cooling	510
Depth [mm]: 42; L 945 mm; Mounting Bores Distance [mm]: 520; Vers. produced by BEHR; W 708 mm	8MK 376 721-761 Radiator, engine cooling	511				
Ø 290 mm	8MV 376 757-221 Clutch, radiator fan	500				
Bore Ø [mm]: 152; Diameter 1 [mm]: 704; Diameter 2 [mm]: 127; Number of Fan Blades: 9; Number of mounting bores: 6	8MV 376 758-561 Fan Wheel, engine cooling	507				
Bore Ø [mm]: 200; Diameter 1 [mm]: 750; Diameter 2 [mm]: 180; Number of Fan Blades: 9	8MV 376 758-571 Fan Wheel, engine cooling	508				
29.460 FVAS 50.460 VFVK, VFV-G	338 kW		05/00→ 10/00→	Capacity [Litre]: 8; Transparent; Depth [mm]: 108; L 743 mm; Vers. produced by BEHR; W 321 mm	8MA 376 705-331 Expansion Tank, coolant	521
				Capacity [Litre]: 14; Black; Depth [mm]: 142; L 743 mm; Vers. produced by BEHR; W 321 mm	8MA 376 705-381 Expansion Tank, coolant	522
				Ø 290 mm	8MV 376 757-221 Clutch, radiator fan	500
				Ø 753 mm; Number of Fan Blades: 9	8MV 376 757-271 Fan, radiator	505
				Bore Ø [mm]: 200; Depth [mm]: 138; Ø 236 mm; Number of mounting bores: 6; 2 pol; elec.	8MV 376 758-511 Clutch, radiator fan	503
				Depth [mm]: 119; Ø 236 mm; Number of mounting bores: 6; 2 pol; elec.	8MV 376 758-541 Clutch, radiator fan	504
				Bore Ø [mm]: 152; Depth [mm]: 114; Ø 190 mm	8MV 376 758-551 Clutch, radiator fan	504
				Bore Ø [mm]: 152; Diameter 1 [mm]: 704; Diameter 2 [mm]: 127; Number of Fan Blades: 9; Number of mounting bores: 6	8MV 376 758-561 Fan Wheel, engine cooling	507
				Bore Ø [mm]: 200; Diameter 1 [mm]: 750; Diameter 2 [mm]: 180; Number of Fan Blades: 9	8MV 376 758-571 Fan Wheel, engine cooling	508

Manufacturer - Model	Power	Displ.	Year of Constr.	Remark	Part Number	Page
MAN - E 2000						05/00→
30.410 FANLK 33.410 DFCL	301 kW 301 kW		05/00→ 05/00→	Capacity [Litre]: 8; Transparent; Depth [mm]: 108; L 743 mm; Vers. produced by BEHR; W 321 mm	8MA 376 705-331 Expansion Tank, coolant	521
				Capacity [Litre]: 14; Black; Depth [mm]: 142; L 743 mm; Vers. produced by BEHR; W 321 mm	8MA 376 705-381 Expansion Tank, coolant	522
				Depth [mm]: 42; L 1,065 mm; Mounting Bores Distance [mm]: 400; Vers. produced by BEHR; W 708 mm	8MK 376 721-461 Radiator, engine cooling	509
				Depth [mm]: 40; L 945 mm; Mounting Bores Distance [mm]: 400; Vers. produced by BEHR; W 708 mm	8MK 376 721-481 Radiator, engine cooling	510
				Depth [mm]: 42; L 945 mm; Mounting Bores Distance [mm]: 520; Vers. produced by BEHR; W 708 mm	8MK 376 721-761 Radiator, engine cooling	511
				Ø 290 mm	8MV 376 757-221 Clutch, radiator fan	500
				Ø 753 mm; Number of Fan Blades: 9	8MV 376 757-271 Fan, radiator	505
				Bore Ø [mm]: 152; Depth [mm]: 114; Ø 190 mm	8MV 376 758-551 Clutch, radiator fan	504
				Bore Ø [mm]: 152; Diameter 1 [mm]: 704; Diameter 2 [mm]: 127; Number of Fan Blades: 9; Number of mounting bores: 6	8MV 376 758-561 Fan Wheel, engine cooling	507
				Bore Ø [mm]: 200; Diameter 1 [mm]: 750; Diameter 2 [mm]: 180; Number of Fan Blades: 9	8MV 376 758-571 Fan Wheel, engine cooling	508
33.600 DFALS, DFAS 33.600 DFSL 40.600 DFAS 50.600 VFAS	441 kW 441 kW 441 kW 441 kW		06/00→ 06/00→ 06/00→ 05/00→	Capacity [Litre]: 8; Transparent; Depth [mm]: 108; L 743 mm; Vers. produced by BEHR; W 321 mm	8MA 376 705-331 Expansion Tank, coolant	521
				Capacity [Litre]: 14; Black; Depth [mm]: 142; L 743 mm; Vers. produced by BEHR; W 321 mm	8MA 376 705-381 Expansion Tank, coolant	522
				Ø 290 mm	8MV 376 757-221 Clutch, radiator fan	500
				Ø 753 mm; Number of Fan Blades: 9	8MV 376 757-271 Fan, radiator	505
				Bore Ø [mm]: 152; Diameter 1 [mm]: 704; Diameter 2 [mm]: 127; Number of Fan Blades: 9; Number of mounting bores: 6	8MV 376 758-561 Fan Wheel, engine cooling	507
				Bore Ø [mm]: 200; Diameter 1 [mm]: 750; Diameter 2 [mm]: 180; Number of Fan Blades: 9	8MV 376 758-571 Fan Wheel, engine cooling	508
41.600 DFVS, DFVLS	441 kW		06/00→	Capacity [Litre]: 8; Transparent; Depth [mm]: 108; L 743 mm; Vers. produced by BEHR; W 321 mm	8MA 376 705-331 Expansion Tank, coolant	521
				Capacity [Litre]: 14; Black; Depth [mm]: 142; L 743 mm; Vers. produced by BEHR; W 321 mm	8MA 376 705-381 Expansion Tank, coolant	522
				Depth [mm]: 40; L 945 mm; Mounting Bores Distance [mm]: 400; Vers. produced by BEHR; W 708 mm	8MK 376 721-481 Radiator, engine cooling	510
				Ø 290 mm	8MV 376 757-221 Clutch, radiator fan	500
				Ø 753 mm; Number of Fan Blades: 9	8MV 376 757-271 Fan, radiator	505
				Bore Ø [mm]: 152; Diameter 1 [mm]: 704; Diameter 2 [mm]: 127; Number of Fan Blades: 9; Number of mounting bores: 6	8MV 376 758-561 Fan Wheel, engine cooling	507
				Bore Ø [mm]: 200; Diameter 1 [mm]: 750; Diameter 2 [mm]: 180; Number of Fan Blades: 9	8MV 376 758-571 Fan Wheel, engine cooling	508
50.410 VFVK, VFV-G	301 kW		10/00→	Capacity [Litre]: 8; Transparent; Depth [mm]: 108; L 743 mm; Vers. produced by BEHR; W 321 mm	8MA 376 705-331 Expansion Tank, coolant	521
				Capacity [Litre]: 14; Black; Depth [mm]: 142; L 743 mm; Vers. produced by BEHR; W 321 mm	8MA 376 705-381 Expansion Tank, coolant	522
				Ø 290 mm	8MV 376 757-221 Clutch, radiator fan	500
				Ø 753 mm; Number of Fan Blades: 9	8MV 376 757-271 Fan, radiator	505
				Bore Ø [mm]: 152; Depth [mm]: 128; Ø 190 mm; Number of mounting bores: 6; 2 pol. elec.	8MV 376 758-471 Clutch, radiator fan	502
				Bore Ø [mm]: 152; Depth [mm]: 114; Ø 190 mm	8MV 376 758-551 Clutch, radiator fan	504
				Bore Ø [mm]: 152; Diameter 1 [mm]: 704; Diameter 2 [mm]: 127; Number of Fan Blades: 9; Number of mounting bores: 6	8MV 376 758-561 Fan Wheel, engine cooling	507
				Bore Ø [mm]: 200; Diameter 1 [mm]: 750; Diameter 2 [mm]: 180; Number of Fan Blades: 9	8MV 376 758-571 Fan Wheel, engine cooling	508
MAN - EL						07/98→
EL 262	191 kW		07/98→		8MK 376 774-501 Radiator, engine cooling	519

Manufacturer - Model	Power	Displ.	Year of Constr.	Remark	Part Number	Page
MAN - EM						08/87→
EM 192	140 kW		10/93→06/97		8MK 376 774-501	519
EM 222, EM 223	162 kW		02/96→		Radiator, engine cooling	
EM 223	162 kW		08/87→			
MAN - F 90						07/86→12/97
19.242 F, 19.242 FL, 19.242 FLL	177 kW		01/88→01/89	+ OE 81061026098: Capacity [Litre]: 8,4; Natural; Depth [mm]: 130; L 742 mm; with filler cap; Vers. ohne Gewindebuchse / Vers. produced by BEHR; W 321 mm	8MA 376 705-231	520
19.242 FS, 19.242 FLS, 19.242 FLLS	177 kW		01/88→01/89		Expansion Tank, coolant	
19.262 FAS	191 kW		02/89→02/90	Capacity [Litre]: 5,6; Natural; Depth [mm]: 130; with coolant level switch connection; L 742 mm; Vers. produced by BEHR; W 321 mm	8MA 376 705-241	520
19.262 FS, 19.262 FLS, 19.262 FLLS	191 kW		01/88→02/90		Expansion Tank, coolant	
19.292 F, 19.292 FL, 19.292 FLL	213 kW		07/86→02/90	Depth [mm]: 47; L 915 mm; W 704 mm	8MK 376 709-561	509
19.292 FA	213 kW		05/88→02/90		Radiator, engine cooling	
19.292 FAS	213 kW		05/88→02/90			
19.292 FS, 19.292 FLS, 19.292 FLLS	213 kW		07/86→02/90			
19.332 F, 19.332 FL, 19.332 FLL	243 kW		07/86→02/90			
19.332 FA	243 kW		05/88→02/90			
19.332 FAS	243 kW		05/88→02/90			
19.332 FS, 19.332 FLS, 19.332 FLLS	243 kW		07/86→02/90			
19.362 F, 19.362 FL, 19.362 FLL	265 kW		07/86→02/90			
19.362 FA	265 kW		05/88→02/90			
19.362 FAS	265 kW		05/88→02/90			
19.362 FS, 19.362 FLS, 19.362 FLLS	265 kW		07/86→02/90			
19.372 F, 19.372 FL, 19.372 FLL	249 kW		05/90→04/95			
19.372 FS, 19.372 FLS, 19.372 FLLS	249 kW		05/90→04/95			
19.462 F, 19.462 FL	338 kW		05/87→02/90			
19.462 FS, 19.462 FLS	338 kW		05/87→02/90			
24.242 DF	177 kW		01/88→07/89			
24.242 DFS	177 kW		01/88→07/89			
24.242 FNL, 24.242 FNLL, 24.242 FVL	177 kW		01/88→02/90			
24.262 DF	191 kW		01/88→02/90			
24.262 DFS, 24.262 DFSL	191 kW		01/88→02/90			
24.262 FNL, 24.262 FNLL, 24.262 FVL	191 kW		01/88→02/90			
24.292 DF	213 kW		04/87→02/90			
24.292 DFS, 24.292 DFSL	213 kW		04/87→02/90			
24.292 FNL, 24.292 FNLL, 24.292 FVL	213 kW		10/86→02/90			
24.292 FNLS, 24.292 FVLS	213 kW		10/86→02/90			
24.322 DF	235 kW		02/90→12/90			
24.322 DFS, 24.322 DFSL	235 kW		02/90→12/90			
24.322 FNL, 24.322 FNLL, 24.322 FVL	235 kW		02/90→05/95			
24.322 FNLS, 24.322 FVLS	235 kW		02/90→05/95			
24.332 DF	243 kW		04/87→02/90			
24.332 DFS, 24.332 DFSL	243 kW		04/87→02/90			
24.332 FNL, 24.332 FNLL, 24.332 FVL	243 kW		10/86→02/90			
24.332 FNLS, 24.332 FVLS	243 kW		10/86→02/90			
24.362 DF	265 kW		04/87→02/90			
24.362 DFS, 24.362 DFSL	265 kW		04/87→02/90			
24.362 FNL, 24.362 FNLL, 24.362 FVL	265 kW		10/86→02/90			
24.362 FNLS, 24.362 FVLS	265 kW		10/86→02/90			
24.372 DF	249 kW		05/90→12/90			
24.372 DFS	249 kW		05/90→12/90			
24.372 FVL	249 kW		05/90→12/90			
24.372 FVLS	249 kW		05/90→12/90			
24.462 FVLS	338 kW		05/87→07/87			
25.372 DF	249 kW		09/90→12/92			
25.372 DFS	249 kW		09/90→12/92			
25.372 FVLS	249 kW		09/90→10/93			
26.242 DF	177 kW		01/88→07/89			
26.242 DFS	177 kW		01/88→07/89			
26.262 DF	191 kW		01/88→02/90			
26.262 DFA	191 kW		02/89→02/90			
26.262 DFAS	191 kW		02/89→02/90			
26.262 DFS	191 kW		01/88→02/90			
26.292 DF, 26.292 DFL	213 kW		09/87→02/90			
26.292 DFA	213 kW		05/88→02/90			
26.292 DFAS	213 kW		05/88→02/90			
26.292 DFS	213 kW		09/87→02/90			
26.332 DF, 26.332 DFL	243 kW		09/87→02/90			
26.332 DFA	243 kW		05/88→02/90			
26.332 DFAS	243 kW		05/88→02/90			

Manufacturer - Model	Power	Displ.	Year of Constr.	Remark	Part Number	Page
MAN - F 90						07/86→12/97
26.332 DFS	243 kW		09/87→02/90	+ OE 81061026098; Capacity [Litre]: 8,4; Natural; Depth [mm]: 130; L 742 mm; with filler cap; Vers. ohne Gewindebuchse / Vers. produced by BEHR; W 321 mm	8MA 376 705-231	520
26.362 DF, 26.362 DFL	265 kW		09/87→02/90		Expansion Tank, coolant	
26.362 DFA	265 kW		05/88→02/90			
				Capacity [Litre]: 5,6; Natural; Depth [mm]: 130; with coolant level switch connection; L 742 mm; Vers. produced by BEHR; W 321 mm	8MA 376 705-241	520
				Depth [mm]: 47; L 915 mm; W 704 mm	8MK 376 709-561	509
					Radiator, engine cooling	
19.242 FK	177 kW		01/88→02/89	Depth [mm]: 47; L 915 mm; W 704 mm	8MK 376 709-561	509
19.262 F, 19.262 FL, 19.262 FLL	191 kW		01/88→02/90			
19.262 FA	191 kW		02/89→02/90			
19.262 FAK	191 kW		02/89→02/90			
19.262 FK	191 kW		01/88→02/90			
19.292 FAK	213 kW		05/88→02/90			
19.292 FK	213 kW		07/86→02/90			
19.332 FAK	243 kW		05/88→02/90			
19.332 FK	243 kW		07/86→02/90			
19.362 FAK	265 kW		05/88→02/90			
19.362 FK	265 kW		07/86→02/90			
19.372 FK	249 kW		05/90→04/95			
19.462 FK	338 kW		05/87→02/90			
24.242 DFK	177 kW		01/88→07/89			
24.262 DFK	191 kW		01/88→02/90			
24.292 DFK	213 kW		04/87→02/90			
24.322 DFK	235 kW		02/90→12/90			
24.332 DFK	243 kW		04/87→02/90			
24.362 DFK	265 kW		04/87→02/90			
24.372 DFK	249 kW		05/90→12/90			
25.372 DFK	249 kW		09/90→12/92			
26.242 DFAK	177 kW		02/89→07/89			
26.242 DFK	177 kW		01/88→07/89			
26.262 DFAK	191 kW		02/89→02/90			
26.262 DFK	191 kW		01/88→02/90			
26.292 DFAK	213 kW		05/88→02/90			
26.292 DFK	213 kW		09/87→02/90			
26.332 DFAK	243 kW		05/88→02/90			
26.332 DFK	243 kW		09/87→02/90			
26.362 DFAK	265 kW		05/88→02/90			
26.362 DFAS	265 kW		05/88→02/90			
26.362 DFK	265 kW		09/87→02/90			
26.362 DFS	265 kW		09/87→02/90			
32.262 VF	191 kW		02/89→02/90			
32.262 VFK	191 kW		02/89→02/90			
32.262 VFTM	191 kW		02/89→02/90			
32.292 VF	213 kW		03/88→02/90			
32.292 VFK	213 kW		03/88→02/90			
32.332 VF	243 kW		03/88→02/90			
32.332 VFK	243 kW		03/88→02/90			
32.342 VFK	250 kW		05/94→06/96			
32.362 VF	265 kW		03/88→02/90			
32.362 VFK	265 kW		03/88→02/90			
32.372 VF	249 kW		02/90→06/96			
32.372 VFK	249 kW		05/90→04/95			
33.242 DFAK	177 kW		01/88→08/88			
33.242 DFK	177 kW		01/88→08/88			
33.262 DF	191 kW		08/88→02/90			
33.262 DFA	191 kW		07/89→02/90			
33.262 DFAK	191 kW		07/89→02/90			
33.262 DFK	191 kW		08/88→02/90			
33.292 DF	213 kW		09/87→02/90			
33.292 DFA	213 kW		05/88→02/90			
33.292 DFAK	213 kW		05/88→02/90			
33.292 DFAS	213 kW		05/88→02/90			
33.292 DFK	213 kW		09/87→02/90			
33.292 DFS	213 kW		09/87→02/90			
33.332 DF	243 kW		09/87→02/90			
33.332 DFA	243 kW		05/88→02/90			
33.332 DFAK	243 kW		05/88→02/90			
33.332 DFAS	243 kW		05/88→02/90			
33.332 DFK	243 kW		09/87→02/90			
33.332 DFS	243 kW		09/87→02/90			
33.342 DF	250 kW		05/94→06/96			
33.342 DFA	250 kW		05/94→06/96			
33.362 DF	265 kW		09/87→02/90			
33.362 DFA	265 kW		05/88→02/90			
33.362 DFAK	265 kW		05/88→02/90			
33.362 DFAS	265 kW		05/88→02/90			
33.362 DFK	265 kW		09/87→02/90			
33.362 DFS	265 kW		09/87→02/90			
35.262 VF	191 kW		02/89→02/90			

Manufacturer - Model	Power	Displ.	Year of Constr.	Remark	Part Number	Page
MAN - F 90						07/86→12/97
35.262 VFA	191 kW		07/89→02/90	Depth [mm]: 47; L 915 mm; W 704 mm	8MK 376 709-561 Radiator, engine cooling	509
35.262 VFK	191 kW		02/89→02/90			
35.292 VF	213 kW		10/88→04/95			
35.292 VFK	213 kW		10/88→04/95			
35.332 VF	243 kW		10/88→04/95			
35.332 VFK	243 kW		10/88→04/95			
35.362 VF	265 kW		10/88→02/90			
35.362 VFK	265 kW		10/88→02/90			
35.372 VF	249 kW		02/90→04/95			
35.372 VFK	249 kW		02/90→04/95			
41.262 VF	191 kW		07/89→02/90			
41.262 VFK	191 kW		07/89→02/90			
41.292 VF	213 kW		10/88→02/90			
41.292 VFK	213 kW		10/88→02/90			
41.332 VF	243 kW		10/88→02/90			
41.332 VFK	243 kW		10/88→02/90			
41.362 VF	265 kW		10/88→02/90			
41.362 VFK	265 kW		10/88→02/90			
19.272 F, 19.272 FL, 19.272 FLL	198 kW		02/90→05/95	+ OE 81061026098 ; Capacity [Litre]: 8,4; Natural; Depth [mm]: 130; L 742 mm; with filler cap; Vers. ohne Gewindebuchse / Vers. produced by BEHR; W 321 mm	8MA 376 705-231	520
19.272 FA	198 kW		02/90→05/95			
19.272 FAS	198 kW		02/90→05/95	Capacity [Litre]: 5,6; Natural; Depth [mm]: 130; with coolant level switch connection; L 742 mm; Vers. produced by BEHR; W 321 mm	8MA 376 705-241	520
19.272 FS, 19.272 FLS, 19.272 FLLS	198 kW		02/90→05/95			
19.322 F, 19.322 FL, 19.322 FLL	235 kW		02/90→05/95	Capacity [Litre]: 5,6; Black; Depth [mm]: 130; with coolant level switch connection; L 742 mm; Vers. produced by BEHR; W 321 mm	8MA 376 705-341	522
19.322 FA	235 kW		02/90→06/96			
19.322 FAS	235 kW		02/90→06/96	Depth [mm]: 47; L 915 mm; W 704 mm	8MK 376 709-561	509
19.342 F, 19.342 FL, 19.342 FLL	250 kW		05/94→05/95			
19.342 FA	250 kW		05/94→06/96	Radiator, engine cooling		
19.342 FAS	250 kW		05/94→06/96			
19.342 FS, 19.342 FLS, 19.342 FLLS	250 kW		05/94→05/95			
19.372 F, 19.372 FL, 19.372 FLL	272 kW		02/90→05/95	Capacity [Litre]: 5,6; Black; Depth [mm]: 130; with coolant level switch connection; L 742 mm; Vers. produced by BEHR; W 321 mm	8MA 376 705-341	522
19.372 FA	272 kW		02/90→06/96			
19.372 FAS	272 kW		02/90→06/96	Depth [mm]: 47; L 915 mm; W 704 mm	8MK 376 709-561	509
19.372 FS, 19.372 FLS, 19.372 FLLS	272 kW		02/90→05/95			
19.402 F, 19.402 FL, 19.402 FLL	294 kW		05/94→05/95	Radiator, engine cooling		
19.402 FA	294 kW		05/94→06/96			
19.402 FAS	294 kW		05/94→06/96			
19.402 FS, 19.402 FLS, 19.402 FLLS	294 kW		05/94→05/95			
19.422 F, 19.422 FL, 19.422 FLL	309 kW		02/90→05/95	Capacity [Litre]: 5,6; Black; Depth [mm]: 130; with coolant level switch connection; L 742 mm; Vers. produced by BEHR; W 321 mm	8MA 376 705-341	522
19.422 FA	309 kW		02/90→06/96			
19.422 FAS	309 kW		02/90→06/96	Depth [mm]: 47; L 915 mm; W 704 mm	8MK 376 709-561	509
19.422 FS, 19.422 FLS, 19.422 FLLS	309 kW		02/90→05/95			
24.272 DF	198 kW		02/90→12/90	Radiator, engine cooling		
24.272 DFS, 24.272 DFSL	198 kW		02/90→04/95			
24.272 FNL, 24.272 FNLL, 24.272 FVL	198 kW		02/90→05/95			
24.272 FNLS, 24.272 FVLS	198 kW		02/90→05/95	Capacity [Litre]: 5,6; Black; Depth [mm]: 130; with coolant level switch connection; L 742 mm; Vers. produced by BEHR; W 321 mm	8MA 376 705-341	522
24.342 FNL, 24.342 FNLL	250 kW		05/94→05/95			
24.372 DF	272 kW		02/90→12/90	Depth [mm]: 47; L 915 mm; W 704 mm	8MK 376 709-561	509
24.372 FNL, 24.372 FNLL, 24.372 FVL	272 kW		02/90→05/95			
24.372 FNLS, 24.372 FVLS	272 kW		02/90→05/95	Radiator, engine cooling		
24.402 FNL, 24.402 FNLL	294 kW		05/94→05/95			
24.422 DF	309 kW		02/90→12/90			
24.422 DFS, 24.422 DFSL	309 kW		02/90→12/90			
24.422 FNL, 24.422 FNLL, 24.422 FVL	309 kW		02/90→05/95			
25.272 DF	198 kW		09/90→12/92	Capacity [Litre]: 5,6; Black; Depth [mm]: 130; with coolant level switch connection; L 742 mm; Vers. produced by BEHR; W 321 mm	8MA 376 705-341	522
25.272 DFS, 25.272 DFSL	198 kW		09/90→12/92			
25.272 FNL, 25.272 FNLL, 25.272 FVL	198 kW		09/90→10/93	Depth [mm]: 47; L 915 mm; W 704 mm	8MK 376 709-561	509
25.322 DF, 25.322 DFL	235 kW		09/90→12/92			
25.322 DFS, 25.322 DFSL	235 kW		09/90→12/92	Radiator, engine cooling		
25.322 FNL, 25.322 FNLL, 25.322 FVL	235 kW		09/90→12/92			
25.322 FNLS, 25.322 FVLS	235 kW		09/90→12/92			
25.372 DF	272 kW		09/90→12/92	Capacity [Litre]: 5,6; Black; Depth [mm]: 130; with coolant level switch connection; L 742 mm; Vers. produced by BEHR; W 321 mm	8MA 376 705-341	522
25.372 DFS, 25.372 DFSL	272 kW		09/90→12/92			
25.372 FNL, 25.372 FNLL, 25.372 FVL	272 kW		09/90→12/92	Depth [mm]: 47; L 915 mm; W 704 mm	8MK 376 709-561	509
25.372 FNLS, 25.372 FVLS	272 kW		09/90→10/93			
25.422 DF	309 kW		09/90→12/92	Radiator, engine cooling		
25.422 DFS, 25.422 DFSL	309 kW		09/90→12/92			
25.422 FNL, 25.422 FNLL	309 kW		09/90→12/92			
25.422 FNLS, 25.422 FVLS	309 kW		09/90→12/92			
26.272 DF	198 kW		02/90→06/96	Capacity [Litre]: 5,6; Black; Depth [mm]: 130; with coolant level switch connection; L 742 mm; Vers. produced by BEHR; W 321 mm	8MA 376 705-341	522
26.272 DFA	198 kW		02/90→12/92			

Manufacturer - Model	Power	Displ.	Year of Constr.	Remark	Part Number	Page
MAN - F 90						07/86→12/97
26.272 DFAS	198 kW		02/90→12/92	+ OE 81061026098; Capacity [Litre]: 8,4; Natural; Depth [mm]: 130; L 742 mm; with filler cap; Vers. ohne Gewindebuchse / Vers. produced by BEHR; W 321 mm	8MA 376 705-231	520 Expansion Tank, coolant
26.272 DFS,26.272 DFLS	198 kW		02/90→06/96			
26.272 FNL,26.272 FNLL	198 kW		03/91→05/95			
26.272 FNLS,26.272 FVLS	198 kW		09/90→12/95			
26.322 DF	235 kW		02/90→06/96	Capacity [Litre]: 5,6; Natural; Depth [mm]: 130; with coolant level switch connection; L 742 mm; Vers. produced by BEHR; W 321 mm	8MA 376 705-241	520 Expansion Tank, coolant
26.322 DFA	235 kW		02/90→12/92			
26.322 DFAS	235 kW		02/90→12/92			
26.322 DFS,26.322 DFLS	235 kW		02/90→06/96	Capacity [Litre]: 5,6; Black; Depth [mm]: 130; with coolant level switch connection; L 742 mm; Vers. produced by BEHR; W 321 mm	8MA 376 705-341	522 Expansion Tank, coolant
26.322 FNL,26.322 FNLL	235 kW		03/91→05/95			
26.322 FNLS,26.322 FVLS	235 kW		09/90→12/95			
26.342 DF,26.342 DFL	250 kW		05/94→06/96	Depth [mm]: 47; L 915 mm; W 704 mm	8MK 376 709-561	509 Radiator, engine cooling
26.342 DFS	250 kW		04/94→06/96			
19.272 FAK	198 kW		02/90→05/95	Capacity [Litre]: 5,6; Black; Depth [mm]: 130; with coolant level switch connection; L 742 mm; Vers. produced by BEHR; W 321 mm	8MA 376 705-341	522 Expansion Tank, coolant
19.272 FK	198 kW		02/90→05/95			
19.322 FAK	235 kW		02/90→06/96			
19.322 FK	235 kW		02/90→05/95	Depth [mm]: 47; L 915 mm; W 704 mm	8MK 376 709-561	509 Radiator, engine cooling
19.322 FS,19.322 FLS,19.322 FLLS	235 kW		02/90→05/95			
19.342 FAK	250 kW		05/94→06/96			
19.342 FK	250 kW		05/94→05/95			
19.372 FAK	272 kW		02/90→06/96			
19.372 FK	272 kW		02/90→05/95			
19.402 FAK	294 kW		05/94→06/96			
19.402 FK	294 kW		05/94→05/95			
19.422 FAK	309 kW		02/90→06/96			
19.422 FK	309 kW		02/90→05/95			
24.272 DFK	198 kW		02/90→12/90			
24.372 DFK	272 kW		02/90→12/90			
24.372 DFS, 24.372 DFSL	272 kW		02/90→04/95			
24.422 DFK	309 kW		02/90→12/90			
25.272 DFK	198 kW		09/90→12/92			
25.322 DFK	235 kW		09/90→12/92			
25.372 DFK	272 kW		09/90→12/92			
25.422 DFK	309 kW		09/90→12/92			
26.272 DFAK	198 kW		02/90→12/92			
26.272 DFK	198 kW		02/90→06/96			
26.322 DFAK	235 kW		02/90→12/92			
26.322 DFK	235 kW		02/92→06/96			
26.342 DFK,26.342 DFLK	250 kW		05/94→06/96			
26.372 DF,26.372 DFL	272 kW		02/90→06/96			
26.372 DFA	272 kW		02/90→12/92			
26.372 DFAK	272 kW		01/92→06/96			
26.372 DFAS	272 kW		02/90→12/92			
26.372 DFK	272 kW		01/92→06/96			
26.372 DFS	272 kW		02/90→06/96			
26.372 FNL,26.372 FNLL,26.372 FVL	272 kW		09/90→12/95			
26.372 FNLS,26.372 FVLS	272 kW		01/92→06/96			
26.402 DF,26.402 DFL	294 kW		05/94→06/96			
26.402 DFK,26.402 DFLK	294 kW		05/94→06/96			
26.402 DFS	294 kW		05/94→12/95			
26.402 FNL,26.402 FNLL,26.402 FVL	294 kW		05/94→06/96			
26.402 FNLS,26.402 FVLS	294 kW		05/94→06/96			
26.422 DF,26.422 DFL	309 kW		02/90→06/96			
26.422 DFA	309 kW		02/90→12/92			
26.422 DFAK	309 kW		02/90→12/92			
26.422 DFAS	309 kW		02/90→12/92			
26.422 DFK	309 kW		02/90→12/95			
26.422 DFS	309 kW		02/90→12/95			
26.422 FNL,26.422 FNLL,26.422 FVL	309 kW		09/90→12/95			
26.422 FNLS,26.422 FVLS	309 kW		01/92→12/95			
32.272 VF	198 kW		02/90→04/95			
32.272 VFK	198 kW		02/90→04/95			
32.322 VF	235 kW		02/90→06/96			
32.322 VFK	235 kW		02/90→06/96			
32.372 VF	272 kW		02/90→06/96			
32.372 VFK	272 kW		02/90→06/96			
32.402 VFK	294 kW		05/94→06/96			
32.422 VF	309 kW		02/90→06/96			
33.272 DF	198 kW		10/92→04/95			
33.272 DFA	198 kW		10/92→04/95			
33.272 FVL	191 - 198 kW		10/92→04/95			
33.322 DF	235 kW		09/91→06/96			
33.322 DFA	235 kW		09/91→06/96			
33.322 FVL	235 kW		09/91→06/96			
33.372 DF	272 kW		09/91→06/96			
33.372 DFA	272 kW		09/91→06/96			
33.372 DFAK	272 kW		01/91→06/96			
33.372 DFK	272 kW		01/91→06/96			

Manufacturer - Model	Power	Displ.	Year of Constr.	Remark	Part Number	Page
MAN - F 90					07/86→12/97	
33.372 DFS	272 kW		09/91→06/96	Capacity [Litre]: 5,6; Black; Depth [mm]: 130; with coolant level switch connection; L 742 mm; Vers. produced by BEHR; W 321 mm	8MA 376 705-341	522
33.402 DF	294 kW		05/94→06/96			
33.402 DFA	294 kW		05/94→06/96	Depth [mm]: 47; L 915 mm; W 704 mm	8MK 376 709-561	509
33.402 DFAK	294 kW		05/94→06/96			
33.402 DFK	294 kW		05/94→06/96	Radiators, engine cooling		
33.402 DFS	294 kW		05/94→06/96			
33.422 DF	309 kW		09/91→06/96			
33.422 DFA	309 kW		09/91→06/96			
33.422 DFAK	309 kW		01/94→06/96			
33.422 DFK	309 kW		01/94→06/96			
33.422 DFS	309 kW		01/94→06/96			
35.272 VF	198 kW		02/90→12/91			
35.272 VFK	198 kW		02/90→12/92			
35.322 VFAK	235 kW		02/90→06/96			
35.322 VFK	235 kW		02/90→06/96			
35.322 VK	235 kW		02/90→06/96			
35.342 VF	250 kW		05/94→06/96			
35.342 VFK	250 kW		05/94→06/96			
35.372 VF	272 kW		02/90→06/96			
35.372 VFK	272 kW		02/90→06/96			
35.402 VF	294 kW		05/94→06/96			
35.402 VFK	294 kW		05/94→06/96			
35.422 VF	309 kW		02/90→06/96			
35.422 VFK	309 kW		02/90→12/97			
35.422 VFK	309 kW		02/90→06/96			
35.422 VFK	309 kW		02/90→12/97			
40.372 DF	272 kW		12/91→06/96			
40.372 DFA	272 kW		12/91→06/96			
40.402 DF	294 kW		05/95→06/96			
40.402 DFA	294 kW		05/95→06/96			
40.422 DF	309 kW		12/91→06/96			
40.422 DFA	309 kW		12/91→06/96			
41.272 VF	198 kW		02/90→12/91			
41.322 VF	235 kW		02/90→06/96			
41.342 VF	250 kW		05/94→06/96			
41.372 VF	272 kW		02/90→06/96			
41.402 VF	294 kW		05/94→06/96			
41.422 VF	309 kW		02/90→06/96			
19.502 F, 19.502 FL, 19.502 FLL	368 kW		02/90→06/96	+ OE 81061026098; Capacity [Litre]: 8,4; Natural; Depth [mm]: 130; L 742 mm; with filler cap; Vers. ohne Gewindebuchse / Vers. produced by BEHR; W 321 mm	8MA 376 705-231	520
19.502 FS, 19.502 FLS, 19.502 FLLS	368 kW		02/90→06/96			
24.502 DF	368 kW		02/90→12/90	Capacity [Litre]: 5,6; Natural; Depth [mm]: 130; with coolant level switch connection; L 742 mm; Vers. produced by BEHR; W 321 mm	8MA 376 705-241	520
24.502 DFS	368 kW		02/90→12/90			
24.502 FNL	368 kW		02/90→12/90	Capacity [Litre]: 5,6; Black; Depth [mm]: 130; with coolant level switch connection; L 742 mm; Vers. produced by BEHR; W 321 mm	8MA 376 705-341	522
25.502 DF	368 kW		09/90→12/92			
25.502 DFS	368 kW		09/90→12/92	Expansion Tank, coolant		
25.502 FNL	368 kW		09/90→12/92			
24.302 DF	220 kW		05/90→12/90	+ OE 81061026098; Capacity [Litre]: 8,4; Natural; Depth [mm]: 130; L 742 mm; with filler cap; Vers. ohne Gewindebuchse / Vers. produced by BEHR; W 321 mm	8MA 376 705-231	520
24.302 DFS, 24.302 DFSL	220 kW		05/90→04/95			
24.302 FNL, 24.302 FNLL, 24.302 FVL	220 kW		05/90→10/90	Capacity [Litre]: 5,6; Natural; Depth [mm]: 130; with coolant level switch connection; L 742 mm; Vers. produced by BEHR; W 321 mm	8MA 376 705-241	520
25.302 DF	220 kW		09/90→12/91			
25.302 DFS, 25.302 DFSL	220 kW		09/90→12/91	Capacity [Litre]: 5,6; Black; Depth [mm]: 130; with coolant level switch connection; L 742 mm; Vers. produced by BEHR; W 321 mm	8MA 376 705-341	522
25.302 FNL, 25.302 FNLL, 25.302 FVL	220 kW		09/90→12/91			
25.302 FNLS, 25.302 FVLS	220 kW		09/90→12/91	Depth [mm]: 47; L 915 mm; W 704 mm	8MK 376 709-561	509
26.302 DF	220 kW		05/90→12/91			
26.302 DFA	220 kW		05/90→12/91	Ø 290 mm	8MV 376 757-221	500
26.302 DFAS	220 kW		05/90→12/91			
26.302 DFS	220 kW		05/90→12/91	Clutch, radiator fan		
26.302 FNL, 26.302 FNLL, 26.302 FVL	220 kW		03/91→12/91			
26.302 FNLS, 26.302 FVLS	220 kW		09/90→12/91	Capacity [Litre]: 5,6; Black; Depth [mm]: 130; with coolant level switch connection; L 742 mm; Vers. produced by BEHR; W 321 mm	8MA 376 705-341	522
24.302 DFK	220 kW		05/90→12/90			
25.302 DFK	220 kW		09/90→12/91	Depth [mm]: 47; L 915 mm; W 704 mm	8MK 376 709-561	509
26.302 DFAK	220 kW		05/90→12/91			
26.302 DFK	220 kW		05/90→12/91	Radiators, engine cooling		
32.302 VF	220 kW		05/90→09/91			
32.302 VFK	220 kW		05/90→09/91	Ø 290 mm	8MV 376 757-221	500
35.302 VF	220 kW		05/90→09/91			
35.302 VFA	220 kW		05/90→09/91	Clutch, radiator fan		
35.302 VFAK	220 kW		05/90→09/91			
35.302 VFK	220 kW		05/90→09/91			
24.462 DF	338 kW		02/89→02/90			
24.462 DFS	338 kW		02/89→02/90	+ OE 81061026098; Capacity [Litre]: 8,4; Natural; Depth [mm]: 130; L 742 mm; with filler cap; Vers. ohne Gewindebuchse / Vers. produced by BEHR; W 321 mm	8MA 376 705-231	520
24.462 FNL	338 kW		04/89→02/90			
				Capacity [Litre]: 5,6; Natural; Depth [mm]: 130; with coolant level switch connection; L 742 mm; Vers. produced by BEHR; W 321 mm	8MA 376 705-241	520
				Expansion Tank, coolant		

Manufacturer - Model	Power	Displ.	Year of Constr.	Remark	Part Number	Page
MAN - F 90					07/86→12/97	
24.502 DFK	368 kW		02/90→12/90	Capacity [Litre]: 5,6; Black; Depth [mm]: 130; with coolant level switch connection; L 742 mm; Vers. produced by BEHR; W 321 mm	8MA 376 705-341	522
26.502 DF	368 kW		02/90→06/96		Expansion Tank, coolant	
26.502 DFA	368 kW		02/90→12/92			
26.502 DFAS	368 kW		02/90→12/92			
26.502 DFS,26.502 DFLS	368 kW		02/90→06/96			
26.502 FNLL,26.502 FNLL	368 kW		09/91→06/96			
33.502 DF	368 kW		09/91→06/96			
33.502 DFA	368 kW		09/91→06/96			
35.372 VF	272 kW		02/90→12/97			
35.372 VFK	272 kW		02/90→12/97			
35.402 VF	294 kW		05/94→12/97			
35.402 VFK	294 kW		05/94→12/97			
40.502 DFA	368 kW		02/90→06/96			
MAN - F 2000					01/94→	
18.273 F, FL, FLL	198 kW		06/94→	Ø 290 mm	8MV 376 757-221	500
				Bore Ø [mm]: 152; Depth [mm]: 114; Ø 190 mm	8MV 376 758-551	504
				Bore Ø [mm]: 152; Diameter 1 [mm]: 704; Diameter 2 [mm]: 127; Number of Fan Blades: 9; Number of mounting bores: 6	8MV 376 758-561	Fan 507
				Bore Ø [mm]: 200; Diameter 1 [mm]: 750; Diameter 2 [mm]: 180; Number of Fan Blades: 9	8MV 376 758-571	Fan 508
19.233 FCNG	170 kW			Depth [mm]: 42; L 1,065 mm; Mounting Bores Distance [mm]: 400; Vers. produced by BEHR; W 708 mm	8MK 376 721-461	509
19.233 FKNG	170 kW			Depth [mm]: 40; L 945 mm; Mounting Bores Distance [mm]: 400; Vers. produced by BEHR; W 708 mm	8MK 376 721-481	510
				Depth [mm]: 42; L 945 mm; Mounting Bores Distance [mm]: 520; Vers. produced by BEHR; W 708 mm	8MK 376 721-761	511
				Ø 290 mm	8MV 376 757-221	500
				Bore Ø [mm]: 152; Diameter 1 [mm]: 704; Diameter 2 [mm]: 127; Number of Fan Blades: 9; Number of mounting bores: 6	8MV 376 758-561	Fan 507
				Bore Ø [mm]: 200; Diameter 1 [mm]: 750; Diameter 2 [mm]: 180; Number of Fan Blades: 9	8MV 376 758-571	Fan 508
19.273 F, FL, FLL	198 kW		01/94→	Depth [mm]: 40; L 945 mm; Mounting Bores Distance [mm]: 400; Vers. produced by BEHR; W 708 mm	8MK 376 721-481	510
19.273 FA	198 kW		01/94→			
19.273 FAK	198 kW		01/94→			
19.273 FK	198 kW		01/94→	Ø 203 mm; Thermic; Vers. produced by BEHR	8MV 376 731-281	500
19.273 FS,19.273 FLS	198 kW		01/94→12/95			
19.293 FAC	213 kW		01/94→	Ø 704 mm; Number of Fan Blades: 8; Vers. produced by BEHR	8MV 376 733-131	Fan 506
19.293 FAK	213 kW		01/94→			
19.293 FAS	213 kW		01/94→			
19.293 FC,19.293 FLC,19.293 FLLC	213 kW		01/94→	Ø 290 mm	8MV 376 757-221	500
19.293 FK,19.293 FLK	213 kW		01/94→	Bore Ø [mm]: 152; Depth [mm]: 114; Ø 190 mm	8MV 376 758-551	504
19.293 FS,19.293 FLS,19.293 FLLS	213 kW		01/94→			
19.323 FAC	235 kW		01/94→12/95	Bore Ø [mm]: 152; Diameter 1 [mm]: 704; Diameter 2 [mm]: 127; Number of Fan Blades: 9; Number of mounting bores: 6	8MV 376 758-561	Fan 507
19.323 FAK	235 kW		01/94→12/95			
19.323 FAS	235 kW		01/94→12/95	Bore Ø [mm]: 200; Diameter 1 [mm]: 750; Diameter 2 [mm]: 180; Number of Fan Blades: 9	8MV 376 758-571	Fan 508
19.323 FC,19.323 FLC,19.323 FLLC	235 kW		01/94→12/95			
19.323 FK,19.323 FLK	235 kW		01/94→12/95			
19.323 FS,19.323 FLS,19.323 FLLS	235 kW		01/94→12/95			
24.273 FNLLC	198 kW		01/94→12/95			
24.293 FNLLC	213 kW		01/94→			
24.323 FNLLC	235 kW		01/94→12/95			
26.273 DFC,26.273 DFCL	198 kW		01/94→12/95			
26.273 DFK,26.273 DFLLK	198 kW		01/94→12/95			
26.273 DFS,26.273 DFSL	198 kW		01/94→12/95			
26.273 FNLC,26.273 FNLLC,	198 kW		01/94→12/95			
26.273 FVLC						
26.273 FNLS,26.273 FVLS	198 kW		01/94→12/95			
27.273 DFAC	198 kW		01/94→12/95			
27.273 DFAK	198 kW		01/94→12/95			
27.273 DFAS	198 kW		01/94→12/95			
27.273 DFC	198 kW		01/94→12/95			
27.273 DFK	198 kW		01/94→12/95			
27.273 DFS	198 kW		01/94→12/95			
27.293 DFC	213 kW		01/94→			
27.293 DFK	213 kW		01/94→			
27.293 DFS	213 kW		01/94→			
27.323 DFAC	235 kW		01/94→12/95			
27.323 DFAK, DFA-KI	235 kW		01/94→			

Manufacturer - Model	Power	Displ.	Year of Constr.	Remark	Part Number	Page
MAN - F 2000						01/94→
27.323 DFAS	235 kW		01/94→12/95	Depth [mm]: 40; L 945 mm; Mounting Bores Distance [mm]: 400; Vers. produced by BEHR; W 708 mm	8MK 376 721-481 Radiator, engine cooling	510
27.323 DFC	235 kW		01/94→			
27.323 DFK, DF-KI	235 kW		01/94→			
27.323 DFS	235 kW		01/94→12/95	Ø 203 mm; Thermic; Vers. produced by BEHR	8MV 376 731-281	500
33.323 DFAC	235 kW		01/94→12/95		Clutch, radiator fan	
33.323 DFAK	235 kW		01/94→12/95	Ø 704 mm; Number of Fan Blades: 8; Vers. produced by BEHR	8MV 376 733-131 Fan	506
33.323 DFAS	235 kW		01/94→12/95		Wheel, engine cooling	
33.323 DFC	235 kW		01/94→12/95	Ø 290 mm	8MV 376 757-221	500
33.323 DFK	235 kW		01/94→12/95		Clutch, radiator fan	
33.323 DFS	235 kW		01/94→12/95	Bore Ø [mm]: 152; Depth [mm]: 114; Ø 190 mm	8MV 376 758-551	504
					Clutch, radiator fan	
				Bore Ø [mm]: 152; Diameter 1 [mm]: 704; Diameter 2 [mm]: 127; Number of Fan Blades: 9; Number of mounting bores: 6	8MV 376 758-561 Fan	507
					Wheel, engine cooling	
				Bore Ø [mm]: 200; Diameter 1 [mm]: 750; Diameter 2 [mm]: 180; Number of Fan Blades: 9	8MV 376 758-571 Fan	508
					Wheel, engine cooling	
19.314 FAC	228 kW		05/01→	Depth [mm]: 42; L 1,065 mm; Mounting Bores Distance [mm]: 400; Vers. produced by BEHR; W 708 mm	8MK 376 721-461	509
19.314 FAK, FA-KI	228 kW		05/01→		Radiator, engine cooling	
24.314 FNLLRC	228 kW		05/01→			
26.314 DFC, DFLC	228 kW		05/01→	Depth [mm]: 40; L 945 mm; Mounting Bores Distance [mm]: 400; Vers. produced by BEHR; W 708 mm	8MK 376 721-481	510
27.314 DFAK, DFA-KI	228 kW		05/01→		Radiator, engine cooling	
27.314 DFAS	228 kW		05/01→			
27.314 DFC	228 kW		05/01→	Depth [mm]: 42; L 945 mm; Mounting Bores Distance [mm]: 520; Vers. produced by BEHR; W 708 mm	8MK 376 721-761	511
27.314 DFK, DF-KI	228 kW		05/01→		Radiator, engine cooling	
27.314 DFS	228 kW		05/01→			
27.314 DF-TM	228 kW		05/01→	Ø 704 mm; Number of Fan Blades: 8; Vers. produced by BEHR	8MV 376 733-131 Fan	506
35.314 VF-TM	228 kW		03/02→		Wheel, engine cooling	
				Ø 290 mm	8MV 376 757-221	500
					Clutch, radiator fan	
				Ø 753 mm; Number of Fan Blades: 9	8MV 376 757-271 Fan,	505
					radiator	
				Bore Ø [mm]: 200; Depth [mm]: 138; Ø 236 mm; Number of mounting bores: 6; 2 pol; elec.	8MV 376 758-511	503
					Clutch, radiator fan	
				Depth [mm]: 119; Ø 236 mm; Number of mounting bores: 6; 2 pol; elec.	8MV 376 758-541	504
					Clutch, radiator fan	
				Bore Ø [mm]: 152; Depth [mm]: 114; Ø 190 mm	8MV 376 758-551	504
					Clutch, radiator fan	
				Bore Ø [mm]: 152; Diameter 1 [mm]: 704; Diameter 2 [mm]: 127; Number of Fan Blades: 9; Number of mounting bores: 6	8MV 376 758-561 Fan	507
					Wheel, engine cooling	
				Bore Ø [mm]: 200; Diameter 1 [mm]: 750; Diameter 2 [mm]: 180; Number of Fan Blades: 9	8MV 376 758-571 Fan	508
					Wheel, engine cooling	
19.314 FAS	228 kW		06/98→	Ø 290 mm	8MV 376 757-221	500
19.314 FK, FLK, F-KI, FL-KI	228 kW		06/98→		Clutch, radiator fan	
40.403 DFAS	294 kW		01/94→			
40.403 DFS	294 kW		01/94→	Ø 753 mm; Number of Fan Blades: 9	8MV 376 757-271 Fan,	505
					radiator	
				Bore Ø [mm]: 152; Depth [mm]: 128; Ø 190 mm; Number of mounting bores: 6; 2 pol; elec.	8MV 376 758-471	502
					Clutch, radiator fan	
				Bore Ø [mm]: 200; Depth [mm]: 138; Ø 236 mm; Number of mounting bores: 6; 2 pol; elec.	8MV 376 758-511	503
					Clutch, radiator fan	
				Depth [mm]: 119; Ø 236 mm; Number of mounting bores: 6; 2 pol; elec.	8MV 376 758-541	504
					Clutch, radiator fan	
				Bore Ø [mm]: 152; Depth [mm]: 114; Ø 190 mm	8MV 376 758-551	504
					Clutch, radiator fan	
				Bore Ø [mm]: 152; Diameter 1 [mm]: 704; Diameter 2 [mm]: 127; Number of Fan Blades: 9; Number of mounting bores: 6	8MV 376 758-561 Fan	507
					Wheel, engine cooling	
				Bore Ø [mm]: 200; Diameter 1 [mm]: 750; Diameter 2 [mm]: 180; Number of Fan Blades: 9	8MV 376 758-571 Fan	508
					Wheel, engine cooling	
19.314 FC, FLC, FLLC, FLLW, FRC, FLRC, FLLRC, FLL, FLLR, F-N	228 kW		06/98→	Depth [mm]: 40; L 945 mm; Mounting Bores Distance [mm]: 400; Vers. produced by BEHR; W 708 mm	8MK 376 721-481	510
					Radiator, engine cooling	
23.314 FNLLC	228 kW		05/01→	Depth [mm]: 42; L 945 mm; Mounting Bores Distance [mm]: 520; Vers. produced by BEHR; W 708 mm	8MK 376 721-761	511
					Radiator, engine cooling	
				Ø 704 mm; Number of Fan Blades: 8; Vers. produced by BEHR	8MV 376 733-131 Fan	506
					Wheel, engine cooling	
				Ø 290 mm	8MV 376 757-221	500
					Clutch, radiator fan	
				Ø 753 mm; Number of Fan Blades: 9	8MV 376 757-271 Fan,	505
					radiator	
				Bore Ø [mm]: 200; Depth [mm]: 138; Ø 236 mm; Number of mounting bores: 6; 2 pol; elec.	8MV 376 758-511	503
					Clutch, radiator fan	
				Depth [mm]: 119; Ø 236 mm; Number of mounting bores: 6; 2 pol; elec.	8MV 376 758-541	504
					Clutch, radiator fan	
				Bore Ø [mm]: 152; Depth [mm]: 114; Ø 190 mm	8MV 376 758-551	504
					Clutch, radiator fan	

Manufacturer - Model	Power	Displ.	Year of Constr.	Remark	Part Number	Page
MAN - F 2000						01/94→
19.314 FC, FLC, FLLC, FLLW, FRC, FLRC, FLLRC, FLL, FLLR, F-N	228 kW		06/98→	Bore Ø [mm]: 152; Diameter 1 [mm]: 704; Diameter 2 [mm]: 127; Number of Fan Blades: 9; Number of mounting bores: 6	8MV 376 758-561 Fan Wheel, engine cooling	507
23.314 FNLLC	228 kW		05/01→	Bore Ø [mm]: 200; Diameter 1 [mm]: 750; Diameter 2 [mm]: 180; Number of Fan Blades: 9	8MV 376 758-571 Fan Wheel, engine cooling	508
19.314 FS, FLS, FLLS, FRS, FLRS, FLLRS	228 kW		06/98→	Depth [mm]: 40; L 945 mm; Mounting Bores Distance [mm]: 400; Vers. produced by BEHR; W 708 mm	8MK 376 721-481 Radiator, engine cooling	510
19.364 FS, FLS, FLLS, FRS, FLRS, FLLRS	265 kW		06/98→	Depth [mm]: 42; L 945 mm; Mounting Bores Distance [mm]: 520; Vers. produced by BEHR; W 708 mm	8MK 376 721-761 Radiator, engine cooling	511
				Ø 290 mm	8MV 376 757-221 Clutch, radiator fan	500
				Ø 753 mm; Number of Fan Blades: 9	8MV 376 757-271 Fan, radiator	505
				Bore Ø [mm]: 152; Depth [mm]: 128; Ø 190 mm; Number of mounting bores: 6; 2 pol; elec.	8MV 376 758-471 Clutch, radiator fan	502
				Bore Ø [mm]: 200; Depth [mm]: 138; Ø 236 mm; Number of mounting bores: 6; 2 pol; elec.	8MV 376 758-511 Clutch, radiator fan	503
				Depth [mm]: 119; Ø 236 mm; Number of mounting bores: 6; 2 pol; elec.	8MV 376 758-541 Clutch, radiator fan	504
				Bore Ø [mm]: 152; Depth [mm]: 114; Ø 190 mm	8MV 376 758-551 Clutch, radiator fan	504
				Bore Ø [mm]: 152; Diameter 1 [mm]: 704; Diameter 2 [mm]: 127; Number of Fan Blades: 9; Number of mounting bores: 6	8MV 376 758-561 Fan Wheel, engine cooling	507
				Bore Ø [mm]: 200; Diameter 1 [mm]: 750; Diameter 2 [mm]: 180; Number of Fan Blades: 9	8MV 376 758-571 Fan Wheel, engine cooling	508
19.343 FAC	250 kW		01/94→	Manual Transmission; for vehicles without air conditioning; Capacity [Litre]: 8; Transparent; Depth [mm]: 108; L 743 mm; Vers. produced by BEHR; W 321 mm	8MA 376 705-331 Expansion Tank, coolant	521
19.343 FAK	250 kW		01/94→			
19.343 FAS	250 kW		01/94→	Manual Transmission; for vehicles without air conditioning; Capacity [Litre]: 14; Black; Depth [mm]: 142; L 743 mm; Vers. produced by BEHR; W 321 mm	8MA 376 705-381 Expansion Tank, coolant	522
19.343 FC, 19.343 FLC, 19.343 FLLC	250 kW		01/94→			
19.343 FK, 19.343 FLK	250 kW		01/94→	Depth [mm]: 40; L 945 mm; Mounting Bores Distance [mm]: 400; Vers. produced by BEHR; W 708 mm	8MK 376 721-481 Radiator, engine cooling	510
19.343 FS, 19.343 FLS, 19.343 FLLS	250 kW		01/94→			
23.343 FNLLC	250 kW		01/94→	Ø 203 mm; Thermic; Vers. produced by BEHR	8MV 376 731-281 Clutch, radiator fan	500
24.343 FNLLC	250 kW		01/94→			
26.343 DFC, 26.343 DFLC	250 kW		01/94→	Ø 704 mm; Number of Fan Blades: 8; Vers. produced by BEHR	8MV 376 733-131 Fan Wheel, engine cooling	506
26.343 DFK, 26.343 DFLK	250 kW		01/94→			
26.343 DFS, 26.343 DFSL	250 kW		01/94→	Ø 290 mm	8MV 376 757-221 Clutch, radiator fan	500
26.343 FNLC, 26.343 FNLLC, 26.343 FVLC	250 kW		01/94→			
26.343 FNLS, 26.343 FVLS	250 kW		01/94→	Bore Ø [mm]: 152; Diameter 1 [mm]: 704; Diameter 2 [mm]: 127; Number of Fan Blades: 9; Number of mounting bores: 6	8MV 376 758-561 Fan Wheel, engine cooling	507
27.343 DFAC	250 kW		01/94→			
27.343 DFAK	250 kW		01/94→	Bore Ø [mm]: 200; Diameter 1 [mm]: 750; Diameter 2 [mm]: 180; Number of Fan Blades: 9	8MV 376 758-571 Fan Wheel, engine cooling	508
27.343 DFAS	250 kW		01/94→			
27.343 DFC	250 kW		01/94→			
27.343 DFK	250 kW		01/94→			
27.343 DFS	250 kW		01/94→			
32.343 VFK	250 kW		08/95→			
33.343 DFAC	250 kW		01/94→			
33.343 DFAK	250 kW		01/94→			
33.343 DFAS	250 kW		01/94→			
33.343 DFC	250 kW		01/94→			
33.343 DFK	250 kW		01/94→			
33.343 DFS	250 kW		01/94→			
19.364 FAC	265 kW		06/98→	Capacity [Litre]: 8; Transparent; Depth [mm]: 108; L 743 mm; Vers. produced by BEHR; W 321 mm	8MA 376 705-331 Expansion Tank, coolant	521
19.364 FAK, FA-KI	265 kW		06/98→			
19.364 FAS	265 kW		06/98→	Capacity [Litre]: 14; Black; Depth [mm]: 142; L 743 mm; Vers. produced by BEHR; W 321 mm	8MA 376 705-381 Expansion Tank, coolant	522
19.364 FK, FLK, F-KI, FL-KI	265 kW		06/98→			
				Ø 290 mm	8MV 376 757-221 Clutch, radiator fan	500
				Ø 753 mm; Number of Fan Blades: 9	8MV 376 757-271 Fan, radiator	505
				Bore Ø [mm]: 152; Depth [mm]: 128; Ø 190 mm; Number of mounting bores: 6; 2 pol; elec.	8MV 376 758-471 Clutch, radiator fan	502
				Bore Ø [mm]: 200; Depth [mm]: 138; Ø 236 mm; Number of mounting bores: 6; 2 pol; elec.	8MV 376 758-511 Clutch, radiator fan	503
				Depth [mm]: 119; Ø 236 mm; Number of mounting bores: 6; 2 pol; elec.	8MV 376 758-541 Clutch, radiator fan	504
				Bore Ø [mm]: 152; Depth [mm]: 114; Ø 190 mm	8MV 376 758-551 Clutch, radiator fan	504
				Bore Ø [mm]: 152; Diameter 1 [mm]: 704; Diameter 2 [mm]: 127; Number of Fan Blades: 9; Number of mounting bores: 6	8MV 376 758-561 Fan Wheel, engine cooling	507
				Bore Ø [mm]: 200; Diameter 1 [mm]: 750; Diameter 2 [mm]: 180; Number of Fan Blades: 9	8MV 376 758-571 Fan Wheel, engine cooling	508

Manufacturer - Model	Power	Displ.	Year of Constr.	Remark	Part Number	Page
MAN - F 2000						01/94→
19.364 FC, FLC, FLLC, FLLW, FRC, FLRC, FLLRC, FLL, FLLR, F-N	265 kW		06/98→	Capacity [Litre]: 8; Transparent; Depth [mm]: 108; L 743 mm; Vers. produced by BEHR; W 321 mm	8MA 376 705-331 Expansion Tank, coolant	521
26.364 DF-TM	265 kW		05/01→	Capacity [Litre]: 14; Black; Depth [mm]: 142; L 743 mm; Vers. produced by BEHR; W 321 mm	8MA 376 705-381 Expansion Tank, coolant	522
32.364 VF, VFC	265 kW		05/01→	Depth [mm]: 40; L 945 mm; Mounting Bores Distance [mm]: 400; Vers. produced by BEHR; W 708 mm	8MK 376 721-481 Radiator, engine cooling	510
32.364 VFK, VF-HK	265 kW		05/01→	Depth [mm]: 42; L 945 mm; Mounting Bores Distance [mm]: 520; Vers. produced by BEHR; W 708 mm	8MK 376 721-761 Radiator, engine cooling	511
32.364 VF-TM	265 kW		05/01→	Ø 290 mm	8MV 376 757-221 Clutch, radiator fan	500
				Ø 753 mm; Number of Fan Blades: 9	8MV 376 757-271 Fan, radiator	505
				Bore Ø [mm]: 152; Depth [mm]: 128; Ø 190 mm; Number of mounting bores: 6; 2 pol; elec.	8MV 376 758-471 Clutch, radiator fan	502
				Bore Ø [mm]: 200; Depth [mm]: 138; Ø 236 mm; Number of mounting bores: 6; 2 pol; elec.	8MV 376 758-511 Clutch, radiator fan	503
				Depth [mm]: 119; Ø 236 mm; Number of mounting bores: 6; 2 pol; elec.	8MV 376 758-541 Clutch, radiator fan	504
				Bore Ø [mm]: 152; Depth [mm]: 114; Ø 190 mm	8MV 376 758-551 Clutch, radiator fan	504
				Bore Ø [mm]: 152; Diameter 1 [mm]: 704; Diameter 2 [mm]: 127; Number of Fan Blades: 9; Number of mounting bores: 6	8MV 376 758-561 Fan Wheel, engine cooling	507
				Bore Ø [mm]: 200; Diameter 1 [mm]: 750; Diameter 2 [mm]: 180; Number of Fan Blades: 9	8MV 376 758-571 Fan Wheel, engine cooling	508
19.373 FAC	272 kW		01/94→	Capacity [Litre]: 8; Transparent; Depth [mm]: 108; L 743 mm; Vers. produced by BEHR; W 321 mm	8MA 376 705-331 Expansion Tank, coolant	521
19.373 FAK, FA-KI	272 kW		01/94→	Capacity [Litre]: 14; Black; Depth [mm]: 142; L 743 mm; Vers. produced by BEHR; W 321 mm	8MA 376 705-381 Expansion Tank, coolant	522
19.373 FAS	272 kW		01/94→	Depth [mm]: 42; L 1,065 mm; Mounting Bores Distance [mm]: 400; Vers. produced by BEHR; W 708 mm	8MK 376 721-461 Radiator, engine cooling	509
19.373 FC, FLC, FLLC, FRC, FLRC, F-NL	272 kW		01/94→	Depth [mm]: 40; L 945 mm; Mounting Bores Distance [mm]: 400; Vers. produced by BEHR; W 708 mm	8MK 376 721-481 Radiator, engine cooling	510
19.373 FK, FLK, F-KI, FL-KI	272 kW		01/94→	Depth [mm]: 42; L 945 mm; Mounting Bores Distance [mm]: 520; Vers. produced by BEHR; W 708 mm	8MK 376 721-761 Radiator, engine cooling	511
19.373 FS, FLS, FLLS, FRS, FLRS, FLLRS	272 kW		01/94→	Ø 203 mm; Thermic; Vers. produced by BEHR	8MV 376 731-281 Clutch, radiator fan	500
19.423 FAC	309 kW		01/94→12/95	Ø 704 mm; Number of Fan Blades: 8; Vers. produced by BEHR	8MV 376 733-131 Fan Wheel, engine cooling	506
19.423 FAK, FA-KI	309 kW		01/94→	Ø 290 mm	8MV 376 757-221 Clutch, radiator fan	500
19.423 FAS	309 kW		01/94→12/95	Ø 753 mm; Number of Fan Blades: 9	8MV 376 757-271 Fan, radiator	505
19.423 FC, FLC, FLLC, F-NL	309 kW		01/94→	Bore Ø [mm]: 152; Depth [mm]: 128; Ø 190 mm; Number of mounting bores: 6; 2 pol; elec.	8MV 376 758-471 Clutch, radiator fan	502
19.423 FK, FLK, F-KI, FL-KI	309 kW		01/94→	Bore Ø [mm]: 200; Depth [mm]: 138; Ø 236 mm; Number of mounting bores: 6; 2 pol; elec.	8MV 376 758-511 Clutch, radiator fan	503
19.423 FS, FLS, FLLS	309 kW		01/94→	Depth [mm]: 119; Ø 236 mm; Number of mounting bores: 6; 2 pol; elec.	8MV 376 758-541 Clutch, radiator fan	504
24.373 FNLLC	272 kW		01/94→12/95	Bore Ø [mm]: 152; Depth [mm]: 114; Ø 190 mm	8MV 376 758-551 Clutch, radiator fan	504
24.423 FNLLC	309 kW		01/94→12/95	Bore Ø [mm]: 152; Diameter 1 [mm]: 704; Diameter 2 [mm]: 127; Number of Fan Blades: 9; Number of mounting bores: 6	8MV 376 758-561 Fan Wheel, engine cooling	507
26.373 DFC,26.373 DFLC	272 kW		01/94→12/95	Bore Ø [mm]: 200; Diameter 1 [mm]: 750; Diameter 2 [mm]: 180; Number of Fan Blades: 9	8MV 376 758-571 Fan Wheel, engine cooling	508
26.373 DFK,26.373 DFLK	272 kW		01/94→12/95			
26.373 DFS,26.373 DFLS	272 kW		01/94→12/95			
26.373 FNLC,26.373 FNLLC,	272 kW		01/94→12/95			
26.373 FVLC						
26.373 FNLS,26.373 FVLS	272 kW		01/94→12/95			
26.423 DFC,26.423 DFLC	309 kW		01/94→12/95			
26.423 DFK,26.423 DFLK	309 kW		01/94→12/95			
26.423 DFS,26.423 DFLS	309 kW		01/94→12/95			
26.423 FNLC,26.423 FNLLC,	309 kW		01/94→12/95			
26.423 FVLC						
26.423 FNLS,26.423 FVLS	309 kW		01/94→12/95			
27.373 DFAC	272 kW		01/94→			
27.373 DFAK, DFA-KI	272 kW		01/94→			
27.373 DFAS	272 kW		01/94→			
27.373 DFC	272 kW		01/94→			
27.373 DFK, DF-KI	272 kW		01/94→			
27.373 DFS	272 kW		01/94→			
27.423 DFAC	309 kW		01/94→			
27.423 DFAK, DFA-KI	309 kW		01/94→			
27.423 DFAS	309 kW		01/94→12/95			
27.423 DFC	309 kW		01/94→			
27.423 DFK, DF-KI	309 kW		01/94→			
27.423 DFS	309 kW		01/94→			
33.373 DFAC	272 kW		01/94→			
33.373 DFAK, DFA-KI	272 kW		01/94→			
33.373 DFAS	272 kW		01/94→			
33.373 DFK, DF-KI	272 kW		01/94→			
33.423 DFAC	309 kW		01/94→			
33.423 DFAK, DFA-KI	309 kW		01/94→			
33.423 DFAS	309 kW		01/94→			
33.423 DFC	309 kW		01/94→			
33.423 DFK, DF-KI	309 kW		01/94→			
33.423 DFS, DFRS	309 kW		01/94→			

Manufacturer - Model	Power	Displ.	Year of Constr.	Remark	Part Number	Page
MAN - F 2000						01/94→
19.403 FAC	294 kW		01/94→	Manual Transmission; for vehicles without air conditioning: Capacity [Litre]: 8; Transparent; Depth [mm]: 108; L 743 mm; Vers. produced by BEHR; W 321 mm	8MA 376 705-331	521
19.403 FAK, FA-KI	294 kW		01/94→		Expansion Tank, coolant	
19.403 FAS	294 kW		01/94→	Manual Transmission; for vehicles without air conditioning: Capacity [Litre]: 14; Black; Depth [mm]: 142; L 743 mm; Vers. produced by BEHR; W 321 mm	8MA 376 705-381	522
19.403 FC, FLC, FLLC, FRC, FLRC, F-NL	294 kW		01/94→		Expansion Tank, coolant	
19.403 FK, FLK, F-KI, FL-KI	294 kW		01/94→	Depth [mm]: 42; L 1,065 mm; Mounting Bores Distance [mm]: 400; Vers. produced by BEHR; W 708 mm	8MK 376 721-461	509
19.403 FS, FLS, FLLS, FRS, FLRS, FLLRS	294 kW		01/94→		Radiator, engine cooling	
24.403 FNLLC	294 kW		01/94→	Depth [mm]: 40; L 945 mm; Mounting Bores Distance [mm]: 400; Vers. produced by BEHR; W 708 mm	8MK 376 721-481	510
26.403 DFC,26.403 DFLC	294 kW		01/94→		Radiator, engine cooling	
26.403 DFK,26.403 DFLK	294 kW		01/94→	Depth [mm]: 42; L 945 mm; Mounting Bores Distance [mm]: 520; Vers. produced by BEHR; W 708 mm	8MK 376 721-761	511
26.403 DFS,26.403 DFLS	294 kW		01/94→		Radiator, engine cooling	
26.403 FNLC,26.403 FNLLC, 26.403 FVLC	294 kW		01/94→	Ø 203 mm; Thermic; Vers. produced by BEHR	8MV 376 731-281	500
26.403 FNLS,26.403 FVLS	294 kW		01/94→		Clutch, radiator fan	
27.403 DFAC	294 kW		01/94→	Ø 704 mm; Number of Fan Blades: 8; Vers. produced by BEHR	8MV 376 733-131	506
27.403 DFAK, DFA-KI	294 kW		01/94→		Fan Wheel, engine cooling	
27.403 DFAS	294 kW		01/94→	Ø 290 mm	8MV 376 757-221	500
27.403 DFC	294 kW		01/94→		Clutch, radiator fan	
27.403 DFK, DF-KI	294 kW		01/94→	Ø 753 mm; Number of Fan Blades: 9	8MV 376 757-271	505
27.403 DFS	294 kW		01/94→		Fan, radiator	
33.403 DFAC	294 kW		01/94→	Bore Ø [mm]: 152; Depth [mm]: 128; Ø 190 mm; Number of mounting bores: 6; 2 pol; elec.	8MV 376 758-471	502
33.403 DFAK, DFA-KI	294 kW		01/94→		Clutch, radiator fan	
33.403 DFAS	294 kW		01/94→	Bore Ø [mm]: 200; Depth [mm]: 138; Ø 236 mm; Number of mounting bores: 6; 2 pol; elec.	8MV 376 758-511	503
33.403 DFC	294 kW		01/94→		Clutch, radiator fan	
33.403 DFK, DF-KI	294 kW		01/94→	Depth [mm]: 119; Ø 236 mm; Number of mounting bores: 6; 2 pol; elec.	8MV 376 758-541	504
33.403 DFS, DFRS	294 kW		01/94→		Clutch, radiator fan	
35.403 VF, VFC, VFRC	294 kW		08/95→	Bore Ø [mm]: 152; Depth [mm]: 114; Ø 190 mm	8MV 376 758-551	504
35.403 VFK, VF-HK, VF-KI	294 kW		03/02→		Clutch, radiator fan	
40.403 DFAK	294 kW		01/94→	Bore Ø [mm]: 152; Diameter 1 [mm]: 704; Diameter 2 [mm]: 127; Number of Fan Blades: 9; Number of mounting bores: 6	8MV 376 758-561	507
41.403 VF, VFC, VFRC	294 kW		08/95→		Fan Wheel, engine cooling	
41.403 VFK, VF-HK, VF-KI	294 kW		08/95→	Bore Ø [mm]: 200; Diameter 1 [mm]: 750; Diameter 2 [mm]: 180; Number of Fan Blades: 9	8MV 376 758-571	508
					Fan Wheel, engine cooling	
19.414 FAC	301 kW		06/98→	Capacity [Litre]: 8; Transparent; Depth [mm]: 108; L 743 mm; Vers. produced by BEHR; W 321 mm	8MA 376 705-331	521
19.414 FAK, FA-KI	301 kW		06/98→		Expansion Tank, coolant	
19.414 FAS	301 kW		06/98→	Capacity [Litre]: 14; Black; Depth [mm]: 142; L 743 mm; Vers. produced by BEHR; W 321 mm	8MA 376 705-381	522
19.414 FK, FLK, F-KI, FL-KI	301 kW		06/98→		Expansion Tank, coolant	
				Ø 290 mm	8MV 376 757-221	500
					Clutch, radiator fan	
				Ø 753 mm; Number of Fan Blades: 9	8MV 376 757-271	505
					Fan, radiator	
				Bore Ø [mm]: 152; Depth [mm]: 128; Ø 190 mm; Number of mounting bores: 6; 2 pol; elec.	8MV 376 758-471	502
					Clutch, radiator fan	
				Bore Ø [mm]: 200; Depth [mm]: 138; Ø 236 mm; Number of mounting bores: 6; 2 pol; elec.	8MV 376 758-511	503
					Clutch, radiator fan	
				Bore Ø [mm]: 152; Depth [mm]: 114; Ø 190 mm	8MV 376 758-551	504
					Clutch, radiator fan	
				Bore Ø [mm]: 152; Diameter 1 [mm]: 704; Diameter 2 [mm]: 127; Number of Fan Blades: 9; Number of mounting bores: 6	8MV 376 758-561	507
					Fan Wheel, engine cooling	
				Bore Ø [mm]: 200; Diameter 1 [mm]: 750; Diameter 2 [mm]: 180; Number of Fan Blades: 9	8MV 376 758-571	508
					Fan Wheel, engine cooling	
19.414 FC, FLC, FLLC, FRC, FLRC, FLLRC, FLL, FLLR, F-NL	301 kW		06/98→	Capacity [Litre]: 8; Transparent; Depth [mm]: 108; L 743 mm; Vers. produced by BEHR; W 321 mm	8MA 376 705-331	521
19.414 FS, FLS, FLLS, FRS, FLRS, FLLRS	301 kW		06/98→		Expansion Tank, coolant	
26.414 DF-TM	301 kW		05/01→	Capacity [Litre]: 14; Black; Depth [mm]: 142; L 743 mm; Vers. produced by BEHR; W 321 mm	8MA 376 705-381	522
32.414 VF, VFC	301 kW		05/01→		Expansion Tank, coolant	
32.414 VFK, VF-HK	301 kW		05/01→	Depth [mm]: 40; L 945 mm; Mounting Bores Distance [mm]: 400; Vers. produced by BEHR; W 708 mm	8MK 376 721-481	510
32.414 VF-TM	301 kW		05/01→		Radiator, engine cooling	
				Depth [mm]: 42; L 945 mm; Mounting Bores Distance [mm]: 520; Vers. produced by BEHR; W 708 mm	8MK 376 721-761	511
					Radiator, engine cooling	
				Ø 290 mm	8MV 376 757-221	500
					Clutch, radiator fan	
				Ø 753 mm; Number of Fan Blades: 9	8MV 376 757-271	505
					Fan, radiator	
				Bore Ø [mm]: 152; Depth [mm]: 128; Ø 190 mm; Number of mounting bores: 6; 2 pol; elec.	8MV 376 758-471	502
					Clutch, radiator fan	
				Bore Ø [mm]: 200; Depth [mm]: 138; Ø 236 mm; Number of mounting bores: 6; 2 pol; elec.	8MV 376 758-511	503
					Clutch, radiator fan	
				Bore Ø [mm]: 152; Depth [mm]: 114; Ø 190 mm	8MV 376 758-551	504
					Clutch, radiator fan	

Manufacturer - Model	Power	Displ.	Year of Constr.	Remark	Part Number	Page
MAN - F 2000						01/94→
19.414 FC, FLC, FLLC, FRC, FLRC, FLLRC, FLL, FLLR, F-NL	301 kW		06/98→	Bore Ø [mm]: 152; Diameter 1 [mm]: 704; Di- ameter 2 [mm]: 127; Number of Fan Blades: 9; Number of mounting bores: 6	8MV 376 758-561 Fan Wheel, engine cooling	507
19.414 FS, FLS, FLLS, FRS, FLRS, FLLRS	301 kW		06/98→	Bore Ø [mm]: 200; Diameter 1 [mm]: 750; Di- ameter 2 [mm]: 180; Number of Fan Blades: 9	8MV 376 758-571 Fan Wheel, engine cooling	508
26.414 DF-TM	301 kW		05/01→			
32.414 VF, VFC	301 kW		05/01→			
32.414 VFK, VF-HK	301 kW		05/01→			
32.414 VF-TM	301 kW		05/01→			
19.463 FAC	338 kW		01/94→	Capacity [Litre]: 8; Transparent; Depth [mm]: 108; L 743 mm; Vers. produced by BEHR; W 321 mm	8MA 376 705-331 Expansion Tank, coolant	521
19.463 FAK, FA-KI	338 kW		01/94→			
19.463 FAS	338 kW		01/94→			
19.463 FC, FLC, FLLC, FRC, FLRC, F-NL	338 kW		01/94→	Capacity [Litre]: 14; Black; Depth [mm]: 142; L 743 mm; Vers. produced by BEHR; W 321 mm	8MA 376 705-381 Expansion Tank, coolant	522
19.463 FK, FLK, F-KI, FL-KI	338 kW		01/94→	Depth [mm]: 42; L 1,065 mm; Mounting Bores	8MK 376 721-461 Radiator, engine cooling	509
19.463 FS, FLS, FLLS, FRS, FLRS, FLLRS	338 kW		01/94→	Distance [mm]: 400; Vers. produced by BEHR; W 708 mm		
19.464 FAC	338 kW		06/98→	Depth [mm]: 40; L 945 mm; Mounting Bores	8MK 376 721-481 Radiator, engine cooling	510
24.463 FNLLC	338 kW		01/94→	Distance [mm]: 400; Vers. produced by BEHR; W 708 mm		
24.464 FNLLRC	338 kW		05/01→			
26.463 DFC, DFRC	338 kW		01/94→	Depth [mm]: 42; L 945 mm; Mounting Bores	8MK 376 721-761 Radiator, engine cooling	511
26.463 DFK,26.463 DFLK	338 kW		01/94→	Distance [mm]: 520; Vers. produced by BEHR; W 708 mm		
26.463 DFS,26.463 DFSL	338 kW		01/94→	Ø 203 mm; Thermic; Vers. produced by BEHR	8MV 376 731-281 Clutch, radiator fan	500
26.463 FNLC, FNLLC, FVLC	338 kW		01/94→			
26.463 FNLS,26.463 FVLS	338 kW		01/94→	Ø 704 mm; Number of Fan Blades: 8; Vers. produced by BEHR	8MV 376 733-131 Fan Wheel, engine cooling	506
26.464 DFC, DFRC	338 kW		05/01→			
26.464 DFK, DFLK	338 kW		05/01→			
26.464 DFS, DFSL	338 kW		05/01→	Ø 290 mm	8MV 376 757-221 Clutch, radiator fan	500
26.464 FNLC, FNLLC, FNLLW, FVLC	338 kW		05/01→	Ø 753 mm; Number of Fan Blades: 9	8MV 376 757-271 Fan, radiator	505
26.464 FNLS	338 kW		05/01→			
26.464 FVL-KO	338 kW		05/01→	Bore Ø [mm]: 200; Depth [mm]: 138; Ø 236 mm; Number of mounting bores: 6; 2 pol; elec.	8MV 376 758-511 Clutch, radiator fan	503
26.464 FVLS, FVLRS	338 kW		05/01→			
27.373 DF-TM	272 kW		07/00→	Depth [mm]: 119; Ø 236 mm; Number of mount- ing bores: 6; 2 pol; elec.	8MV 376 758-541 Clutch, radiator fan	504
27.423 DF-TM	309 kW		07/00→			
27.463 DFAC	338 kW		01/94→	Bore Ø [mm]: 152; Depth [mm]: 114; Ø 190 mm	8MV 376 758-551 Clutch, radiator fan	504
27.463 DFAK, DFA-KI	338 kW		01/94→			
27.463 DFAS	338 kW		01/94→			
27.463 DFC	338 kW		01/94→			
27.463 DFK, DF-KI	338 kW		01/94→	Bore Ø [mm]: 152; Diameter 1 [mm]: 704; Di- ameter 2 [mm]: 127; Number of Fan Blades: 9; Number of mounting bores: 6	8MV 376 758-561 Fan Wheel, engine cooling	507
27.463 DFS	338 kW		01/94→			
27.463 DF-TM	338 kW		07/00→	Bore Ø [mm]: 200; Diameter 1 [mm]: 750; Di- ameter 2 [mm]: 180; Number of Fan Blades: 9	8MV 376 758-571 Fan Wheel, engine cooling	508
27.464 DFAC	338 kW		05/01→			
27.464 DFAK, DFA-KI	338 kW		05/01→			
27.464 DFAS	338 kW		05/01→			
27.464 DFC	338 kW		01/94→			
27.464 DFK, DF-KI	338 kW		05/01→			
27.464 DFS	338 kW		01/94→			
27.464 DF-TM	338 kW		05/01→			
33.373 DFC	272 kW		01/94→			
33.463 DFAC	338 kW		01/94→			
33.463 DFAK, DFA-KI	338 kW		01/94→			
33.463 DFC	338 kW		01/94→			
33.463 DFK, DF-KI	338 kW		01/94→			
33.463 DFS, DFRS	338 kW		01/94→			
33.464 DFAC	338 kW		05/01→			
33.464 DFAK, DFA-KI	338 kW		05/01→			
33.464 DFAS	338 kW		05/01→			
33.464 DFC	338 kW		05/01→			
33.464 DFK, DF-KI	338 kW		05/01→			
33.464 DFS, DFRS	338 kW		05/01→			
35.373 VF, VFC, VFRC	272 kW		05/01→			
35.373 VFK, VF-HK, VF-KI	272 kW		03/02→			
35.423 VF, VFC	309 kW		05/01→			
35.423 VFK, VF-HK, VF-KI	309 kW		03/02→			
35.463 VF, VFC, VFRC	338 kW		08/95→			
35.463 VFK, VF-HK, VF-KI	338 kW		08/95→			
35.464 VF, VFC, VFRC	338 kW		05/01→			
35.464 VFK, VF-HK, VF-KI	338 kW		03/02→			
35.464 VF-TM	338 kW		03/02→			
40.373 DFAK	272 kW		05/01→			
40.423 DFAK	309 kW		05/01→			
40.423 DFK	309 kW		05/01→			
41.373 VF, VFC, VFRC	272 kW		05/01→			
41.373 VFK, VF-HK, VF-KI	272 kW		03/02→			
41.423 VF, VFC, VFRC	309 kW		05/01→			
41.423 VFK, VF-HK, VF-KI	309 kW		03/02→			
41.463 VF, VFC, VFRC	338 kW		08/95→			
41.463 VFK, VF-HK, VF-KI	338 kW		08/95→			
41.464 VF, VFC, VFRC	338 kW		06/98→			
41.464 VFK, VF-HK, VF-KI	338 kW		03/02→			

Manufacturer - Model	Power	Displ.	Year of Constr.	Remark	Part Number	Page
MAN - F 2000						01/94→
19.464 FAK, FA-KI	338 kW		06/98→	Capacity [Litre]: 8; Transparent; Depth [mm]: 108; L 743 mm; Vers. produced by BEHR; W 321 mm	8MA 376 705-331 Expansion Tank, coolant	521
19.464 FAS	338 kW		06/98→			
19.464 FK, FLK, F-KI, FL-KI	338 kW		06/98→			
				Capacity [Litre]: 14; Black; Depth [mm]: 142; L 743 mm; Vers. produced by BEHR; W 321 mm	8MA 376 705-381 Expansion Tank, coolant	522
				Ø 203 mm; Thermic; Vers. produced by BEHR	8MV 376 731-281 Clutch, radiator fan	500
				Ø 704 mm; Number of Fan Blades: 8; Vers. produced by BEHR	8MV 376 733-131 Fan Wheel, engine cooling	506
				Ø 290 mm	8MV 376 757-221 Clutch, radiator fan	500
				Ø 753 mm; Number of Fan Blades: 9	8MV 376 757-271 Fan, radiator	505
				Bore Ø [mm]: 200; Depth [mm]: 138; Ø 236 mm; Number of mounting bores: 6; 2 pol; elec.	8MV 376 758-511 Clutch, radiator fan	503
				Depth [mm]: 119; Ø 236 mm; Number of mounting bores: 6; 2 pol; elec.	8MV 376 758-541 Clutch, radiator fan	504
				Bore Ø [mm]: 152; Depth [mm]: 114; Ø 190 mm	8MV 376 758-551 Clutch, radiator fan	504
				Bore Ø [mm]: 152; Diameter 1 [mm]: 704; Diameter 2 [mm]: 127; Number of Fan Blades: 9; Number of mounting bores: 6	8MV 376 758-561 Fan Wheel, engine cooling	507
				Bore Ø [mm]: 200; Diameter 1 [mm]: 750; Diameter 2 [mm]: 180; Number of Fan Blades: 9	8MV 376 758-571 Fan Wheel, engine cooling	508
19.464 FC, FLC, FLLC, FLL, FRC, FLLR, FLLRC, FLLW, F-NL	338 kW		06/98→	Capacity [Litre]: 8; Transparent; Depth [mm]: 108; L 743 mm; Vers. produced by BEHR; W 321 mm	8MA 376 705-331 Expansion Tank, coolant	521
19.464 FS, FLS, FLLS, FRS, FLRS, FLLRS	338 kW		06/98→			
23.464 FNLLC	338 kW		05/01→	Capacity [Litre]: 14; Black; Depth [mm]: 142; L 743 mm; Vers. produced by BEHR; W 321 mm	8MA 376 705-381 Expansion Tank, coolant	522
26.464 DF-TM	338 kW		05/01→	Depth [mm]: 40; L 945 mm; Mounting Bores	8MK 376 721-481 Radiator, engine cooling	510
32.463 VFC	338 kW		08/95→	Distance [mm]: 400; Vers. produced by BEHR; W 708 mm		
32.463 VFK	338 kW		08/95→			
32.464 VF, VFC	338 kW		05/01→	Depth [mm]: 42; L 945 mm; Mounting Bores	8MK 376 721-761 Radiator, engine cooling	511
32.464 VFK, VF-HK	338 kW		05/01→	Distance [mm]: 520; Vers. produced by BEHR; W 708 mm		
32.464 VF-TM	338 kW		05/01→			
40.373 DFK	272 kW		05/01→	Ø 203 mm; Thermic; Vers. produced by BEHR	8MV 376 731-281 Clutch, radiator fan	500
				Ø 704 mm; Number of Fan Blades: 8; Vers. produced by BEHR	8MV 376 733-131 Fan Wheel, engine cooling	506
				Ø 290 mm	8MV 376 757-221 Clutch, radiator fan	500
				Ø 753 mm; Number of Fan Blades: 9	8MV 376 757-271 Fan, radiator	505
				Bore Ø [mm]: 200; Depth [mm]: 138; Ø 236 mm; Number of mounting bores: 6; 2 pol; elec.	8MV 376 758-511 Clutch, radiator fan	503
				Depth [mm]: 119; Ø 236 mm; Number of mounting bores: 6; 2 pol; elec.	8MV 376 758-541 Clutch, radiator fan	504
				Bore Ø [mm]: 152; Depth [mm]: 114; Ø 190 mm	8MV 376 758-551 Clutch, radiator fan	504
				Bore Ø [mm]: 152; Diameter 1 [mm]: 704; Diameter 2 [mm]: 127; Number of Fan Blades: 9; Number of mounting bores: 6	8MV 376 758-561 Fan Wheel, engine cooling	507
				Bore Ø [mm]: 200; Diameter 1 [mm]: 750; Diameter 2 [mm]: 180; Number of Fan Blades: 9	8MV 376 758-571 Fan Wheel, engine cooling	508
19.603 FLS, 19604 FLS	441 kW		04/96→	Capacity [Litre]: 8; Transparent; Depth [mm]: 108; L 743 mm; Vers. produced by BEHR; W 321 mm	8MA 376 705-331 Expansion Tank, coolant	521
26.603 DFC, DFCL	441 kW		06/96→			
26.603 DFK, DFLK	441 kW		06/96→			
26.603 DFS, DFSL	441 kW		06/96→	Capacity [Litre]: 14; Black; Depth [mm]: 142; L 743 mm; Vers. produced by BEHR; W 321 mm	8MA 376 705-381 Expansion Tank, coolant	522
26.604 DFSL	441 kW		04/00→			
27.603 DFAS	441 kW		01/96→	Ø 290 mm	8MV 376 757-221 Clutch, radiator fan	500
27.603 DFS	441 kW		01/96→			
33.603 DFAC	441 kW		06/96→	Ø 753 mm; Number of Fan Blades: 9	8MV 376 757-271 Fan, radiator	505
33.603 DFAS	441 kW		06/96→			
33.603 DFC	441 kW		06/96→			
33.603 DFS	441 kW		06/96→	Bore Ø [mm]: 152; Diameter 1 [mm]: 704; Diameter 2 [mm]: 127; Number of Fan Blades: 9; Number of mounting bores: 6	8MV 376 758-561 Fan Wheel, engine cooling	507
				Bore Ø [mm]: 200; Diameter 1 [mm]: 750; Diameter 2 [mm]: 180; Number of Fan Blades: 9	8MV 376 758-571 Fan Wheel, engine cooling	508
23.293 FNLLC	213 kW		01/94→	Manual Transmission; for vehicles without air conditioning: Capacity [Litre]: 8; Transparent; Depth [mm]: 108; L 743 mm; Vers. produced by BEHR; W 321 mm	8MA 376 705-331 Expansion Tank, coolant	521
				Manual Transmission; for vehicles without air conditioning: Capacity [Litre]: 14; Black; Depth [mm]: 142; L 743 mm; Vers. produced by BEHR; W 321 mm	8MA 376 705-381 Expansion Tank, coolant	522
				Depth [mm]: 40; L 945 mm; Mounting Bores	8MK 376 721-481 Radiator, engine cooling	510
				Distance [mm]: 400; Vers. produced by BEHR; W 708 mm		

Manufacturer - Model	Power	Displ.	Year of Constr.	Remark	Part Number	Page				
MAN - F 2000						01/94→				
23.293 FNLLC	213 kW		01/94→	Ø 203 mm; Thermic; Vers. produced by BEHR	8MV 376 731-281 Clutch, radiator fan	500				
				Ø 704 mm; Number of Fan Blades: 8; Vers. produced by BEHR	8MV 376 733-131 Fan Wheel, engine cooling	506				
				Ø 290 mm	8MV 376 757-221 Clutch, radiator fan	500				
				Ø 753 mm; Number of Fan Blades: 9	8MV 376 757-271 Fan, radiator	505				
				Bore Ø [mm]: 152; Depth [mm]: 114; Ø 190 mm	8MV 376 758-551 Clutch, radiator fan	504				
				Bore Ø [mm]: 152; Diameter 1 [mm]: 704; Diameter 2 [mm]: 127; Number of Fan Blades: 9; Number of mounting bores: 6	8MV 376 758-561 Fan Wheel, engine cooling	507				
				Bore Ø [mm]: 200; Diameter 1 [mm]: 750; Diameter 2 [mm]: 180; Number of Fan Blades: 9	8MV 376 758-571 Fan Wheel, engine cooling	508				
23.364 FNLLC	265 kW		05/01→	Capacity [Litre]: 8; Transparent; Depth [mm]: 108; L 743 mm; Vers. produced by BEHR; W 321 mm	8MA 376 705-331 Expansion Tank, coolant	521				
				Capacity [Litre]: 14; Black; Depth [mm]: 142; L 743 mm; Vers. produced by BEHR; W 321 mm	8MA 376 705-381 Expansion Tank, coolant	522				
				Depth [mm]: 40; L 945 mm; Mounting Bores Distance [mm]: 400; Vers. produced by BEHR; W 708 mm	8MK 376 721-481 Radiator, engine cooling	510				
				Depth [mm]: 42; L 945 mm; Mounting Bores Distance [mm]: 520; Vers. produced by BEHR; W 708 mm	8MK 376 721-761 Radiator, engine cooling	511				
				Ø 290 mm	8MV 376 757-221 Clutch, radiator fan	500				
				Ø 753 mm; Number of Fan Blades: 9	8MV 376 757-271 Fan, radiator	505				
				Bore Ø [mm]: 200; Depth [mm]: 138; Ø 236 mm; Number of mounting bores: 6; 2 pol; elec.	8MV 376 758-511 Clutch, radiator fan	503				
				Depth [mm]: 119; Ø 236 mm; Number of mounting bores: 6; 2 pol; elec.	8MV 376 758-541 Clutch, radiator fan	504				
				Bore Ø [mm]: 152; Depth [mm]: 114; Ø 190 mm	8MV 376 758-551 Clutch, radiator fan	504				
				Bore Ø [mm]: 152; Diameter 1 [mm]: 704; Diameter 2 [mm]: 127; Number of Fan Blades: 9; Number of mounting bores: 6	8MV 376 758-561 Fan Wheel, engine cooling	507				
				Bore Ø [mm]: 200; Diameter 1 [mm]: 750; Diameter 2 [mm]: 180; Number of Fan Blades: 9	8MV 376 758-571 Fan Wheel, engine cooling	508				
23.403 FNLLC 23.463 FNLLC	294 kW 338 kW		01/94→ 01/94→	Manual Transmission; for vehicles without air conditioning; Capacity [Litre]: 8; Transparent; Depth [mm]: 108; L 743 mm; Vers. produced by BEHR; W 321 mm	8MA 376 705-331 Expansion Tank, coolant	521				
				Manual Transmission; for vehicles without air conditioning; Capacity [Litre]: 14; Black; Depth [mm]: 142; L 743 mm; Vers. produced by BEHR; W 321 mm	8MA 376 705-381 Expansion Tank, coolant	522				
				Depth [mm]: 40; L 945 mm; Mounting Bores Distance [mm]: 400; Vers. produced by BEHR; W 708 mm	8MK 376 721-481 Radiator, engine cooling	510				
				Depth [mm]: 42; L 945 mm; Mounting Bores Distance [mm]: 520; Vers. produced by BEHR; W 708 mm	8MK 376 721-761 Radiator, engine cooling	511				
				Ø 203 mm; Thermic; Vers. produced by BEHR	8MV 376 731-281 Clutch, radiator fan	500				
				Ø 704 mm; Number of Fan Blades: 8; Vers. produced by BEHR	8MV 376 733-131 Fan Wheel, engine cooling	506				
				Ø 290 mm	8MV 376 757-221 Clutch, radiator fan	500				
				Ø 753 mm; Number of Fan Blades: 9	8MV 376 757-271 Fan, radiator	505				
				Bore Ø [mm]: 200; Depth [mm]: 138; Ø 236 mm; Number of mounting bores: 6; 2 pol; elec.	8MV 376 758-511 Clutch, radiator fan	503				
				Depth [mm]: 119; Ø 236 mm; Number of mounting bores: 6; 2 pol; elec.	8MV 376 758-541 Clutch, radiator fan	504				
				Bore Ø [mm]: 152; Depth [mm]: 114; Ø 190 mm	8MV 376 758-551 Clutch, radiator fan	504				
				Bore Ø [mm]: 152; Diameter 1 [mm]: 704; Diameter 2 [mm]: 127; Number of Fan Blades: 9; Number of mounting bores: 6	8MV 376 758-561 Fan Wheel, engine cooling	507				
				Bore Ø [mm]: 200; Diameter 1 [mm]: 750; Diameter 2 [mm]: 180; Number of Fan Blades: 9	8MV 376 758-571 Fan Wheel, engine cooling	508				
				23.414 FNLLC 40.414 DFK	301 kW 301 kW		05/01→ 05/01→	Capacity [Litre]: 8; Transparent; Depth [mm]: 108; L 743 mm; Vers. produced by BEHR; W 321 mm	8MA 376 705-331 Expansion Tank, coolant	521
								Capacity [Litre]: 14; Black; Depth [mm]: 142; L 743 mm; Vers. produced by BEHR; W 321 mm	8MA 376 705-381 Expansion Tank, coolant	522

Manufacturer - Model	Power	Displ.	Year of Constr.	Remark	Part Number	Page
MAN - F 2000						01/94→
23.414 FNLLC	301 kW		05/01→	Depth [mm]: 40; L 945 mm; Mounting Bores	8MK 376 721-481	510
40.414 DFK	301 kW		05/01→	Distance [mm]: 400; Vers. produced by BEHR; W 708 mm	Radiator, engine cooling	
				Depth [mm]: 42; L 945 mm; Mounting Bores	8MK 376 721-761	511
				Distance [mm]: 520; Vers. produced by BEHR; W 708 mm	Radiator, engine cooling	
				Ø 290 mm	8MV 376 757-221	500
					Clutch, radiator fan	
				Ø 753 mm; Number of Fan Blades: 9	8MV 376 757-271	505
					Fan, radiator	
				Bore Ø [mm]: 200; Depth [mm]: 138; Ø 236 mm; Number of mounting bores: 6; 2 pol; elec.	8MV 376 758-511	503
					Clutch, radiator fan	
				Bore Ø [mm]: 152; Depth [mm]: 114; Ø 190 mm	8MV 376 758-551	504
					Clutch, radiator fan	
				Bore Ø [mm]: 152; Diameter 1 [mm]: 704; Diameter 2 [mm]: 127; Number of Fan Blades: 9; Number of mounting bores: 6	8MV 376 758-561	507
					Fan Wheel, engine cooling	
				Bore Ø [mm]: 200; Diameter 1 [mm]: 750; Diameter 2 [mm]: 180; Number of Fan Blades: 9	8MV 376 758-571	508
					Fan Wheel, engine cooling	
24.364 FNLLRC	265 kW		05/01→	Capacity [Litre]: 8; Transparent; Depth [mm]: 108; L 743 mm; Vers. produced by BEHR; W 321 mm	8MA 376 705-331	521
27.364 DFAK, DFA-KI	265 kW		05/01→		Expansion Tank, coolant	
27.364 DFAS	265 kW		05/01→			
27.364 DFC	265 kW		05/01→	Capacity [Litre]: 14; Black; Depth [mm]: 142; L 743 mm; Vers. produced by BEHR; W 321 mm	8MA 376 705-381	522
27.364 DFK, DF-KI	265 kW		05/01→		Expansion Tank, coolant	
27.364 DFS	265 kW		05/01→	Depth [mm]: 42; L 1,065 mm; Mounting Bores	8MK 376 721-461	509
27.364 DF-TM	265 kW		05/01→	Distance [mm]: 400; Vers. produced by BEHR; W 708 mm	Radiator, engine cooling	
33.364 DFAC	265 kW		05/01→			
33.364 DFAK, DFA-KI	265 kW		05/01→	Depth [mm]: 40; L 945 mm; Mounting Bores	8MK 376 721-481	510
33.364 DFAS	265 kW		05/01→	Distance [mm]: 400; Vers. produced by BEHR; W 708 mm	Radiator, engine cooling	
33.364 DFC	265 kW		05/01→			
33.364 DFK, DF-KI	265 kW		05/01→	Depth [mm]: 42; L 945 mm; Mounting Bores	8MK 376 721-761	511
33.364 DFS, DFRS	265 kW		05/01→	Distance [mm]: 520; Vers. produced by BEHR; W 708 mm	Radiator, engine cooling	
41.364 VF, VFC, VFRC	265 kW		05/01→			
41.364 VFK, VF-HK, VF-KI	265 kW		03/02→	Ø 290 mm	8MV 376 757-221	500
					Clutch, radiator fan	
				Ø 753 mm; Number of Fan Blades: 9	8MV 376 757-271	505
					Fan, radiator	
				Bore Ø [mm]: 200; Depth [mm]: 138; Ø 236 mm; Number of mounting bores: 6; 2 pol; elec.	8MV 376 758-511	503
					Clutch, radiator fan	
				Depth [mm]: 119; Ø 236 mm; Number of mounting bores: 6; 2 pol; elec.	8MV 376 758-541	504
					Clutch, radiator fan	
				Bore Ø [mm]: 152; Depth [mm]: 114; Ø 190 mm	8MV 376 758-551	504
					Clutch, radiator fan	
				Bore Ø [mm]: 152; Diameter 1 [mm]: 704; Diameter 2 [mm]: 127; Number of Fan Blades: 9; Number of mounting bores: 6	8MV 376 758-561	507
					Fan Wheel, engine cooling	
				Bore Ø [mm]: 200; Diameter 1 [mm]: 750; Diameter 2 [mm]: 180; Number of Fan Blades: 9	8MV 376 758-571	508
					Fan Wheel, engine cooling	
24.414 FNLLRC	301 kW		05/01→	Capacity [Litre]: 8; Transparent; Depth [mm]: 108; L 743 mm; Vers. produced by BEHR; W 321 mm	8MA 376 705-331	521
27.414 DFAK, DFA-KI	301 kW		05/01→		Expansion Tank, coolant	
27.414 DFAS	301 kW		05/01→			
27.414 DFC	301 kW		05/01→	Capacity [Litre]: 14; Black; Depth [mm]: 142; L 743 mm; Vers. produced by BEHR; W 321 mm	8MA 376 705-381	522
27.414 DFK, DF-KI	301 kW		05/01→		Expansion Tank, coolant	
27.414 DFS	301 kW		05/01→	Depth [mm]: 42; L 1,065 mm; Mounting Bores	8MK 376 721-461	509
27.414 DF-TM	301 kW		05/01→	Distance [mm]: 400; Vers. produced by BEHR; W 708 mm	Radiator, engine cooling	
33.414 DFAC	301 kW		05/01→			
33.414 DFAK, DFA-KI	301 kW		05/01→	Depth [mm]: 40; L 945 mm; Mounting Bores	8MK 376 721-481	510
33.414 DFAS	301 kW		05/01→	Distance [mm]: 400; Vers. produced by BEHR; W 708 mm	Radiator, engine cooling	
33.414 DFC	301 kW		05/01→			
33.414 DFK, DF-KI	301 kW		05/01→	Depth [mm]: 42; L 945 mm; Mounting Bores	8MK 376 721-761	511
33.414 DFS, DFRS	301 kW		05/01→	Distance [mm]: 520; Vers. produced by BEHR; W 708 mm	Radiator, engine cooling	
40.414 DFAK	301 kW		05/01→			
41.414 VF, VFC, VFRC	301 kW		05/01→	Ø 290 mm	8MV 376 757-221	500
41.414 VFK, VF-HK, VF-KI	301 kW		03/02→		Clutch, radiator fan	
				Ø 753 mm; Number of Fan Blades: 9	8MV 376 757-271	505
					Fan, radiator	
				Bore Ø [mm]: 200; Depth [mm]: 138; Ø 236 mm; Number of mounting bores: 6; 2 pol; elec.	8MV 376 758-511	503
					Clutch, radiator fan	
				Bore Ø [mm]: 152; Depth [mm]: 114; Ø 190 mm	8MV 376 758-551	504
					Clutch, radiator fan	
				Bore Ø [mm]: 152; Diameter 1 [mm]: 704; Diameter 2 [mm]: 127; Number of Fan Blades: 9; Number of mounting bores: 6	8MV 376 758-561	507
					Fan Wheel, engine cooling	
				Bore Ø [mm]: 200; Diameter 1 [mm]: 750; Diameter 2 [mm]: 180; Number of Fan Blades: 9	8MV 376 758-571	508
					Fan Wheel, engine cooling	
26.233 FVL CNG	170 kW		09/96→	Depth [mm]: 42; L 1,065 mm; Mounting Bores	8MK 376 721-461	509
26.233 FVL-KO	170 kW		03/00→	Distance [mm]: 400; Vers. produced by BEHR; W 708 mm	Radiator, engine cooling	
				Depth [mm]: 40; L 945 mm; Mounting Bores	8MK 376 721-481	510
				Distance [mm]: 400; Vers. produced by BEHR; W 708 mm	Radiator, engine cooling	

Manufacturer - Model	Power	Displ.	Year of Constr.	Remark	Part Number	Page
MAN - F 2000						01/94→
26.233 FVL CNG	170 kW		09/96→	Depth [mm]: 42; L 945 mm; Mounting Bores	8MK 376 721-761	511
26.233 FVL-KO	170 kW		03/00→	Distance [mm]: 520; Vers. produced by BEHR; W 708 mm	Radiator, engine cooling	
				Ø 290 mm	8MV 376 757-221	500
					Clutch, radiator fan	
				Ø 753 mm; Number of Fan Blades: 9	8MV 376 757-271	505
					Fan, radiator	
				Bore Ø [mm]: 152; Diameter 1 [mm]: 704; Diameter 2 [mm]: 127; Number of Fan Blades: 9; Number of mounting bores: 6	8MV 376 758-561	507
					Fan Wheel, engine cooling	
				Bore Ø [mm]: 200; Diameter 1 [mm]: 750; Diameter 2 [mm]: 180; Number of Fan Blades: 9	8MV 376 758-571	508
					Fan Wheel, engine cooling	
26.293 DFC,26.293 DFCL	213 kW		01/94→	Manual Transmission; for vehicles without air conditioning; Capacity [Litre]: 8; Transparent; Depth [mm]: 108; L 743 mm; Vers. produced by BEHR; W 321 mm	8MA 376 705-331	521
26.293 DFK,26.293 DFLK	213 kW		01/94→		Expansion Tank, coolant	
26.293 DFS,26.293 DFSL	213 kW		01/94→			
26.293 FNLC,26.293 FNLLC,	213 kW		01/94→			
26.293 FVLC				Manual Transmission; for vehicles without air conditioning; Capacity [Litre]: 14; Black; Depth [mm]: 142; L 743 mm; Vers. produced by BEHR; W 321 mm	8MA 376 705-381	522
26.293 FNLS,26.293 FVLS	213 kW		01/94→		Expansion Tank, coolant	
27.293 DFAC	213 kW		01/94→			
27.293 DFAK	213 kW		01/94→			
27.293 DFAS	213 kW		01/94→	Depth [mm]: 40; L 945 mm; Mounting Bores	8MK 376 721-481	510
32.293 VFC	213 kW		08/95→	Distance [mm]: 400; Vers. produced by BEHR; W 708 mm	Radiator, engine cooling	
32.343 VFC	250 kW		08/95→			
				Ø 203 mm; Thermic; Vers. produced by BEHR	8MV 376 731-281	500
					Clutch, radiator fan	
				Ø 704 mm; Number of Fan Blades: 8; Vers. produced by BEHR	8MV 376 733-131	506
					Fan Wheel, engine cooling	
				Ø 290 mm	8MV 376 757-221	500
					Clutch, radiator fan	
				Bore Ø [mm]: 152; Depth [mm]: 114; Ø 190 mm	8MV 376 758-551	504
					Clutch, radiator fan	
				Bore Ø [mm]: 152; Diameter 1 [mm]: 704; Diameter 2 [mm]: 127; Number of Fan Blades: 9; Number of mounting bores: 6	8MV 376 758-561	507
					Fan Wheel, engine cooling	
				Bore Ø [mm]: 200; Diameter 1 [mm]: 750; Diameter 2 [mm]: 180; Number of Fan Blades: 9	8MV 376 758-571	508
					Fan Wheel, engine cooling	
26.314 DFK, DFLK	228 kW		05/01→	Depth [mm]: 42; L 1,065 mm; Mounting Bores	8MK 376 721-461	509
26.314 DFS, DFSL	228 kW		05/01→	Distance [mm]: 400; Vers. produced by BEHR; W 708 mm	Radiator, engine cooling	
26.314 FNLC, FNLLC, FNLLRC, FNLLW, FVLC	228 kW		05/01→			
26.314 FNLS	228 kW		05/01→	Depth [mm]: 40; L 945 mm; Mounting Bores	8MK 376 721-481	510
26.314 FVL-KO	228 kW		05/01→	Distance [mm]: 400; Vers. produced by BEHR; W 708 mm	Radiator, engine cooling	
26.314 FVLS, FVLSR	228 kW		05/01→			
27.314 DFAC	228 kW		05/01→	Depth [mm]: 42; L 945 mm; Mounting Bores	8MK 376 721-761	511
				Distance [mm]: 520; Vers. produced by BEHR; W 708 mm	Radiator, engine cooling	
				Ø 704 mm; Number of Fan Blades: 8; Vers. produced by BEHR	8MV 376 733-131	506
					Fan Wheel, engine cooling	
				Ø 290 mm	8MV 376 757-221	500
					Clutch, radiator fan	
				Ø 753 mm; Number of Fan Blades: 9	8MV 376 757-271	505
					Fan, radiator	
				Bore Ø [mm]: 152; Depth [mm]: 128; Ø 190 mm; Number of mounting bores: 6; 2 pol; elec.	8MV 376 758-471	502
					Clutch, radiator fan	
				Bore Ø [mm]: 200; Depth [mm]: 138; Ø 236 mm; Number of mounting bores: 6; 2 pol; elec.	8MV 376 758-511	503
					Clutch, radiator fan	
				Depth [mm]: 119; Ø 236 mm; Number of mounting bores: 6; 2 pol; elec.	8MV 376 758-541	504
					Clutch, radiator fan	
				Bore Ø [mm]: 152; Depth [mm]: 114; Ø 190 mm	8MV 376 758-551	504
					Clutch, radiator fan	
				Bore Ø [mm]: 152; Diameter 1 [mm]: 704; Diameter 2 [mm]: 127; Number of Fan Blades: 9; Number of mounting bores: 6	8MV 376 758-561	507
					Fan Wheel, engine cooling	
				Bore Ø [mm]: 200; Diameter 1 [mm]: 750; Diameter 2 [mm]: 180; Number of Fan Blades: 9	8MV 376 758-571	508
					Fan Wheel, engine cooling	
26.314 DF-TM	228 kW		05/01→	Depth [mm]: 40; L 945 mm; Mounting Bores	8MK 376 721-481	510
32.314 VF, VFC	228 kW		05/01→	Distance [mm]: 400; Vers. produced by BEHR; W 708 mm	Radiator, engine cooling	
32.314 VFK, VF-HK	228 kW		05/01→			
32.314 VF-TM	228 kW		05/01→	Depth [mm]: 42; L 945 mm; Mounting Bores	8MK 376 721-761	511
				Distance [mm]: 520; Vers. produced by BEHR; W 708 mm	Radiator, engine cooling	
				Ø 704 mm; Number of Fan Blades: 8; Vers. produced by BEHR	8MV 376 733-131	506
					Fan Wheel, engine cooling	
				Ø 290 mm	8MV 376 757-221	500
					Clutch, radiator fan	
				Ø 753 mm; Number of Fan Blades: 9	8MV 376 757-271	505
					Fan, radiator	
				Bore Ø [mm]: 152; Depth [mm]: 128; Ø 190 mm; Number of mounting bores: 6; 2 pol; elec.	8MV 376 758-471	502
					Clutch, radiator fan	
				Bore Ø [mm]: 200; Depth [mm]: 138; Ø 236 mm; Number of mounting bores: 6; 2 pol; elec.	8MV 376 758-511	503
					Clutch, radiator fan	

Manufacturer - Model	Power	Displ.	Year of Constr.	Remark	Part Number	Page
MAN - F 2000						01/94→
26.314 DF-TM	228 kW		05/01→	Depth [mm]: 119; Ø 236 mm; Number of mounting bores: 6; 2 pol; elec.	8MV 376 758-541 Clutch, radiator fan	504
32.314 VF, VFC	228 kW		05/01→			
32.314 VFK, VF-HK	228 kW		05/01→	Bore Ø [mm]: 152; Depth [mm]: 114; Ø 190 mm	8MV 376 758-551 Clutch, radiator fan	504
32.314 VF-TM	228 kW		05/01→			
				Bore Ø [mm]: 152; Diameter 1 [mm]: 704; Diameter 2 [mm]: 127; Number of Fan Blades: 9; Number of mounting bores: 6	8MV 376 758-561 Fan	507
					Wheel, engine cooling	
				Bore Ø [mm]: 200; Diameter 1 [mm]: 750; Diameter 2 [mm]: 180; Number of Fan Blades: 9	8MV 376 758-571 Fan	508
					Wheel, engine cooling	
26.323 DFC,26.323 DFLC	235 kW		01/94→12/95	Depth [mm]: 40; L 945 mm; Mounting Bores	8MK 376 721-481	510
26.323 DFK,26.323 DFLK	235 kW		01/94→12/95	Distance [mm]: 400; Vers. produced by BEHR;	Radiator, engine cooling	
26.323 DFS,26.323 DFLS	235 kW		01/94→12/95	W 708 mm		
26.323 FNLC,26.323 FNLLC,	235 kW		01/94→12/95	Ø 203 mm; Thermic; Vers. produced by BEHR	8MV 376 731-281	500
26.323 FVLC					Clutch, radiator fan	
26.323 FNLS,26.323 FVLS	235 kW		01/94→12/95	Ø 704 mm; Number of Fan Blades: 8; Vers. produced by BEHR	8MV 376 733-131 Fan	506
					Wheel, engine cooling	
				Ø 290 mm	8MV 376 757-221	500
					Clutch, radiator fan	
				Bore Ø [mm]: 152; Depth [mm]: 128; Ø 190 mm; Number of mounting bores: 6; 2 pol; elec.	8MV 376 758-471	502
					Clutch, radiator fan	
				Bore Ø [mm]: 152; Depth [mm]: 114; Ø 190 mm	8MV 376 758-551	504
					Clutch, radiator fan	
				Bore Ø [mm]: 152; Diameter 1 [mm]: 704; Diameter 2 [mm]: 127; Number of Fan Blades: 9; Number of mounting bores: 6	8MV 376 758-561 Fan	507
					Wheel, engine cooling	
				Bore Ø [mm]: 200; Diameter 1 [mm]: 750; Diameter 2 [mm]: 180; Number of Fan Blades: 9	8MV 376 758-571 Fan	508
					Wheel, engine cooling	
26.364 DFC, DFLC	265 kW		05/01→	Capacity [Litre]: 8; Transparent; Depth [mm]: 108; L 743 mm; Vers. produced by BEHR; W 321 mm	8MA 376 705-331	521
26.364 DFK, DFLK	265 kW		05/01→		Expansion Tank, coolant	
26.364 DFS, DFLS	265 kW		05/01→			
26.364 FNLC, FNLLC, FNLLRC, FNLLW, FVLC	265 kW		05/01→	Capacity [Litre]: 14; Black; Depth [mm]: 142; L 743 mm; Vers. produced by BEHR; W 321 mm	8MA 376 705-381	522
					Expansion Tank, coolant	
26.364 FNLS	265 kW		05/01→	Depth [mm]: 42; L 1,065 mm; Mounting Bores	8MK 376 721-461	509
26.364 FVL-KO	265 kW		05/01→	Distance [mm]: 400; Vers. produced by BEHR;	Radiator, engine cooling	
26.364 FVLS, FVLRS	265 kW		05/01→	W 708 mm		
27.364 DFAC	265 kW		05/01→	Depth [mm]: 40; L 945 mm; Mounting Bores	8MK 376 721-481	510
35.364 VF, VFC, VFRC	265 kW		05/01→	Distance [mm]: 400; Vers. produced by BEHR;	Radiator, engine cooling	
35.364 VFK, VF-HK, VF-KI	265 kW		03/02→	W 708 mm		
35.364 VF-TM	265 kW		03/02→	Depth [mm]: 42; L 945 mm; Mounting Bores	8MK 376 721-761	511
				Distance [mm]: 520; Vers. produced by BEHR;	Radiator, engine cooling	
				W 708 mm		
				Ø 290 mm	8MV 376 757-221	500
					Clutch, radiator fan	
				Ø 753 mm; Number of Fan Blades: 9	8MV 376 757-271 Fan,	505
					radiator	
				Bore Ø [mm]: 152; Depth [mm]: 128; Ø 190 mm; Number of mounting bores: 6; 2 pol; elec.	8MV 376 758-471	502
					Clutch, radiator fan	
				Bore Ø [mm]: 200; Depth [mm]: 138; Ø 236 mm; Number of mounting bores: 6; 2 pol; elec.	8MV 376 758-511	503
					Clutch, radiator fan	
				Depth [mm]: 119; Ø 236 mm; Number of mounting bores: 6; 2 pol; elec.	8MV 376 758-541	504
					Clutch, radiator fan	
				Bore Ø [mm]: 152; Depth [mm]: 114; Ø 190 mm	8MV 376 758-551	504
					Clutch, radiator fan	
				Bore Ø [mm]: 152; Diameter 1 [mm]: 704; Diameter 2 [mm]: 127; Number of Fan Blades: 9; Number of mounting bores: 6	8MV 376 758-561 Fan	507
					Wheel, engine cooling	
				Bore Ø [mm]: 200; Diameter 1 [mm]: 750; Diameter 2 [mm]: 180; Number of Fan Blades: 9	8MV 376 758-571 Fan	508
					Wheel, engine cooling	
26.414 DFC, DFLC	301 kW		05/01→	Capacity [Litre]: 8; Transparent; Depth [mm]: 108; L 743 mm; Vers. produced by BEHR; W 321 mm	8MA 376 705-331	521
26.414 DFK, DFLK	301 kW		05/01→		Expansion Tank, coolant	
26.414 DFS, DFLS	301 kW		05/01→			
26.414 FNLC, FNLLC, FNLLRC, FNLLW, FVLC	301 kW		05/01→	Capacity [Litre]: 14; Black; Depth [mm]: 142; L 743 mm; Vers. produced by BEHR; W 321 mm	8MA 376 705-381	522
					Expansion Tank, coolant	
26.414 FNLS	301 kW		05/01→	Depth [mm]: 42; L 1,065 mm; Mounting Bores	8MK 376 721-461	509
26.414 FVL-KO	301 kW		05/01→	Distance [mm]: 400; Vers. produced by BEHR;	Radiator, engine cooling	
26.414 FVLS, FVLRS	301 kW		05/01→	W 708 mm		
27.414 DFAC	301 kW		05/01→	Depth [mm]: 40; L 945 mm; Mounting Bores	8MK 376 721-481	510
35.414 VF, VFC, VFRC	301 kW		05/01→	Distance [mm]: 400; Vers. produced by BEHR;	Radiator, engine cooling	
35.414 VFK, VF-HK, VF-KI	301 kW		03/02→	W 708 mm		
35.414 VF-TM	301 kW		03/02→	Depth [mm]: 42; L 945 mm; Mounting Bores	8MK 376 721-761	511
				Distance [mm]: 520; Vers. produced by BEHR;	Radiator, engine cooling	
				W 708 mm		
				Ø 290 mm	8MV 376 757-221	500
					Clutch, radiator fan	
				Ø 753 mm; Number of Fan Blades: 9	8MV 376 757-271 Fan,	505
					radiator	
				Bore Ø [mm]: 152; Depth [mm]: 128; Ø 190 mm; Number of mounting bores: 6; 2 pol; elec.	8MV 376 758-471	502
					Clutch, radiator fan	

Manufacturer - Model	Power	Displ.	Year of Constr.	Remark	Part Number	Page
MAN - F 2000						01/94→
26.414 DFC, DFCL	301 kW		05/01→	Bore Ø [mm]: 200; Depth [mm]: 138; Ø 236 mm; Number of mounting bores: 6; 2 pol; elec.	8MV 376 758-511 Clutch, radiator fan	503
26.414 DFK, DFLK	301 kW		05/01→			
26.414 DFS, DFSL	301 kW		05/01→	Bore Ø [mm]: 152; Depth [mm]: 114; Ø 190 mm	8MV 376 758-551 Clutch, radiator fan	504
26.414 FNLC, FNLLC, FNLLRC, FNLLW, FVLC	301 kW		05/01→	Bore Ø [mm]: 152; Diameter 1 [mm]: 704; Diameter 2 [mm]: 127; Number of Fan Blades: 9; Number of mounting bores: 6	8MV 376 758-561 Fan Wheel, engine cooling	507
26.414 FNLS	301 kW		05/01→			
26.414 FVL-KO	301 kW		05/01→	Bore Ø [mm]: 200; Diameter 1 [mm]: 750; Diameter 2 [mm]: 180; Number of Fan Blades: 9	8MV 376 758-571 Fan Wheel, engine cooling	508
26.414 FVLS, FVLRS	301 kW		05/01→			
27.414 DFAC	301 kW		05/01→			
35.414 VF, VFC, VFRC	301 kW		05/01→			
35.414 VFK, VF-HK, VF-KI	301 kW		03/02→			
35.414 VF-TM	301 kW		03/02→			
27.314 FVL	228 kW		06/98→	Depth [mm]: 42; L 1,065 mm; Mounting Bores Distance [mm]: 400; Vers. produced by BEHR; W 708 mm	8MK 376 721-461 Radiator, engine cooling	509
27.364 FVL	265 kW		06/98→			
				Depth [mm]: 40; L 945 mm; Mounting Bores Distance [mm]: 400; Vers. produced by BEHR; W 708 mm	8MK 376 721-481 Radiator, engine cooling	510
				Depth [mm]: 42; L 945 mm; Mounting Bores Distance [mm]: 520; Vers. produced by BEHR; W 708 mm	8MK 376 721-761 Radiator, engine cooling	511
				Ø 290 mm	8MV 376 757-221 Clutch, radiator fan	500
				Ø 753 mm; Number of Fan Blades: 9	8MV 376 757-271 Fan, radiator	505
				Bore Ø [mm]: 152; Depth [mm]: 128; Ø 190 mm; Number of mounting bores: 6; 2 pol; elec.	8MV 376 758-471 Clutch, radiator fan	502
				Bore Ø [mm]: 200; Depth [mm]: 138; Ø 236 mm; Number of mounting bores: 6; 2 pol; elec.	8MV 376 758-511 Clutch, radiator fan	503
				Depth [mm]: 119; Ø 236 mm; Number of mounting bores: 6; 2 pol; elec.	8MV 376 758-541 Clutch, radiator fan	504
				Bore Ø [mm]: 152; Depth [mm]: 114; Ø 190 mm	8MV 376 758-551 Clutch, radiator fan	504
				Bore Ø [mm]: 152; Diameter 1 [mm]: 704; Diameter 2 [mm]: 127; Number of Fan Blades: 9; Number of mounting bores: 6	8MV 376 758-561 Fan Wheel, engine cooling	507
				Bore Ø [mm]: 200; Diameter 1 [mm]: 750; Diameter 2 [mm]: 180; Number of Fan Blades: 9	8MV 376 758-571 Fan Wheel, engine cooling	508
27.403 DF-TM	294 kW		07/00→	Manual Transmission; for vehicles without air conditioning; Capacity [Litre]: 8; Transparent; Depth [mm]: 108; L 743 mm; Vers. produced by BEHR; W 321 mm	8MA 376 705-331 Expansion Tank, coolant	521
				Manual Transmission; for vehicles without air conditioning; Capacity [Litre]: 14; Black; Depth [mm]: 142; L 743 mm; Vers. produced by BEHR; W 321 mm	8MA 376 705-381 Expansion Tank, coolant	522
				Depth [mm]: 42; L 1,065 mm; Mounting Bores Distance [mm]: 400; Vers. produced by BEHR; W 708 mm	8MK 376 721-461 Radiator, engine cooling	509
				Depth [mm]: 40; L 945 mm; Mounting Bores Distance [mm]: 400; Vers. produced by BEHR; W 708 mm	8MK 376 721-481 Radiator, engine cooling	510
				Depth [mm]: 42; L 945 mm; Mounting Bores Distance [mm]: 520; Vers. produced by BEHR; W 708 mm	8MK 376 721-761 Radiator, engine cooling	511
				Ø 203 mm; Thermic; Vers. produced by BEHR	8MV 376 731-281 Clutch, radiator fan	500
				Ø 704 mm; Number of Fan Blades: 8; Vers. produced by BEHR	8MV 376 733-131 Fan Wheel, engine cooling	506
				Ø 290 mm	8MV 376 757-221 Clutch, radiator fan	500
				Ø 753 mm; Number of Fan Blades: 9	8MV 376 757-271 Fan, radiator	505
				Bore Ø [mm]: 200; Depth [mm]: 138; Ø 236 mm; Number of mounting bores: 6; 2 pol; elec.	8MV 376 758-511 Clutch, radiator fan	503
				Depth [mm]: 119; Ø 236 mm; Number of mounting bores: 6; 2 pol; elec.	8MV 376 758-541 Clutch, radiator fan	504
				Bore Ø [mm]: 152; Depth [mm]: 114; Ø 190 mm	8MV 376 758-551 Clutch, radiator fan	504
				Bore Ø [mm]: 152; Diameter 1 [mm]: 704; Diameter 2 [mm]: 127; Number of Fan Blades: 9; Number of mounting bores: 6	8MV 376 758-561 Fan Wheel, engine cooling	507
				Bore Ø [mm]: 200; Diameter 1 [mm]: 750; Diameter 2 [mm]: 180; Number of Fan Blades: 9	8MV 376 758-571 Fan Wheel, engine cooling	508
27.414 FVL	301 kW		06/98→	Depth [mm]: 42; L 1,065 mm; Mounting Bores Distance [mm]: 400; Vers. produced by BEHR; W 708 mm	8MK 376 721-461 Radiator, engine cooling	509
				Depth [mm]: 40; L 945 mm; Mounting Bores Distance [mm]: 400; Vers. produced by BEHR; W 708 mm	8MK 376 721-481 Radiator, engine cooling	510

Manufacturer - Model	Power	Displ.	Year of Constr.	Remark	Part Number	Page				
MAN - F 2000						01/94→				
27.414 FVL	301 kW		06/98→	Depth [mm]: 42; L 945 mm; Mounting Bores Distance [mm]: 520; Vers. produced by BEHR; W 708 mm	8MK 376 721-761	511 Radiator, engine cooling				
				Ø 290 mm	8MV 376 757-221	500 Clutch, radiator fan				
				Ø 753 mm; Number of Fan Blades: 9	8MV 376 757-271	505 Fan, radiator				
				Bore Ø [mm]: 152; Depth [mm]: 128; Ø 190 mm; Number of mounting bores: 6; 2 pol; elec.	8MV 376 758-471	502 Clutch, radiator fan				
				Bore Ø [mm]: 200; Depth [mm]: 138; Ø 236 mm; Number of mounting bores: 6; 2 pol; elec.	8MV 376 758-511	503 Clutch, radiator fan				
				Bore Ø [mm]: 152; Depth [mm]: 114; Ø 190 mm	8MV 376 758-551	504 Clutch, radiator fan				
				Bore Ø [mm]: 152; Diameter 1 [mm]: 704; Diameter 2 [mm]: 127; Number of Fan Blades: 9; Number of mounting bores: 6	8MV 376 758-561	507 Fan Wheel, engine cooling				
				Bore Ø [mm]: 200; Diameter 1 [mm]: 750; Diameter 2 [mm]: 180; Number of Fan Blades: 9	8MV 376 758-571	508 Fan Wheel, engine cooling				
27.464 FVL 40.463 DFAK 40.463 DFAS	338 kW 338 kW 338 kW		06/98→ 01/94→ 01/94→	Depth [mm]: 42; L 1,065 mm; Mounting Bores Distance [mm]: 400; Vers. produced by BEHR; W 708 mm	8MK 376 721-461	509 Radiator, engine cooling				
				Depth [mm]: 40; L 945 mm; Mounting Bores Distance [mm]: 400; Vers. produced by BEHR; W 708 mm	8MK 376 721-481	510 Radiator, engine cooling				
				Depth [mm]: 42; L 945 mm; Mounting Bores Distance [mm]: 520; Vers. produced by BEHR; W 708 mm	8MK 376 721-761	511 Radiator, engine cooling				
				Ø 290 mm	8MV 376 757-221	500 Clutch, radiator fan				
				Ø 753 mm; Number of Fan Blades: 9	8MV 376 757-271	505 Fan, radiator				
				Bore Ø [mm]: 200; Depth [mm]: 138; Ø 236 mm; Number of mounting bores: 6; 2 pol; elec.	8MV 376 758-511	503 Clutch, radiator fan				
				Depth [mm]: 119; Ø 236 mm; Number of mounting bores: 6; 2 pol; elec.	8MV 376 758-541	504 Clutch, radiator fan				
				Bore Ø [mm]: 152; Depth [mm]: 114; Ø 190 mm	8MV 376 758-551	504 Clutch, radiator fan				
32.403 VFC 32.403 VFK 40.403 DFK	294 kW 294 kW 294 kW		08/95→ 08/95→ 01/94→	Manual Transmission; for vehicles without air conditioning; Capacity [Litre]: 8; Transparent; Depth [mm]: 108; L 743 mm; Vers. produced by BEHR; W 321 mm	8MA 376 705-331	521 Expansion Tank, coolant				
				Manual Transmission; for vehicles without air conditioning; Capacity [Litre]: 14; Black; Depth [mm]: 142; L 743 mm; Vers. produced by BEHR; W 321 mm	8MA 376 705-381	522 Expansion Tank, coolant				
				Depth [mm]: 40; L 945 mm; Mounting Bores Distance [mm]: 400; Vers. produced by BEHR; W 708 mm	8MK 376 721-481	510 Radiator, engine cooling				
				Depth [mm]: 42; L 945 mm; Mounting Bores Distance [mm]: 520; Vers. produced by BEHR; W 708 mm	8MK 376 721-761	511 Radiator, engine cooling				
				Ø 203 mm; Thermic; Vers. produced by BEHR	8MV 376 731-281	500 Clutch, radiator fan				
				Ø 704 mm; Number of Fan Blades: 8; Vers. produced by BEHR	8MV 376 733-131	506 Fan Wheel, engine cooling				
				Ø 290 mm	8MV 376 757-221	500 Clutch, radiator fan				
				Ø 753 mm; Number of Fan Blades: 9	8MV 376 757-271	505 Fan, radiator				
				Bore Ø [mm]: 152; Depth [mm]: 128; Ø 190 mm; Number of mounting bores: 6; 2 pol; elec.	8MV 376 758-471	502 Clutch, radiator fan				
				Bore Ø [mm]: 200; Depth [mm]: 138; Ø 236 mm; Number of mounting bores: 6; 2 pol; elec.	8MV 376 758-511	503 Clutch, radiator fan				
				Depth [mm]: 119; Ø 236 mm; Number of mounting bores: 6; 2 pol; elec.	8MV 376 758-541	504 Clutch, radiator fan				
				Bore Ø [mm]: 152; Depth [mm]: 114; Ø 190 mm	8MV 376 758-551	504 Clutch, radiator fan				
				Bore Ø [mm]: 152; Diameter 1 [mm]: 704; Diameter 2 [mm]: 127; Number of Fan Blades: 9; Number of mounting bores: 6	8MV 376 758-561	507 Fan Wheel, engine cooling				
				Bore Ø [mm]: 200; Diameter 1 [mm]: 750; Diameter 2 [mm]: 180; Number of Fan Blades: 9	8MV 376 758-571	508 Fan Wheel, engine cooling				
				33.373 DFS, DFRS	272 kW		01/94→	Depth [mm]: 42; L 1,065 mm; Mounting Bores Distance [mm]: 400; Vers. produced by BEHR; W 708 mm	8MK 376 721-461	509 Radiator, engine cooling

Manufacturer - Model	Power	Displ.	Year of Constr.	Remark	Part Number	Page				
MAN - F 2000						01/94→				
33.373 DFS, DFRS	272 kW		01/94→	Depth [mm]: 40; L 945 mm; Mounting Bores Distance [mm]: 400; Vers. produced by BEHR; W 708 mm	8MK 376 721-481	510 Radiator, engine cooling				
				Depth [mm]: 42; L 945 mm; Mounting Bores Distance [mm]: 520; Vers. produced by BEHR; W 708 mm	8MK 376 721-761	511 Radiator, engine cooling				
				Ø 203 mm; Thermic; Vers. produced by BEHR	8MV 376 731-281	500 Clutch, radiator fan				
				Ø 704 mm; Number of Fan Blades: 8; Vers. produced by BEHR	8MV 376 733-131	506 Fan Wheel, engine cooling				
				Ø 290 mm	8MV 376 757-221	500 Clutch, radiator fan				
				Ø 753 mm; Number of Fan Blades: 9	8MV 376 757-271	505 Fan, radiator				
				Bore Ø [mm]: 152; Depth [mm]: 128; Ø 190 mm; Number of mounting bores: 6; 2 pol; elec.	8MV 376 758-471	502 Clutch, radiator fan				
				Bore Ø [mm]: 200; Depth [mm]: 138; Ø 236 mm; Number of mounting bores: 6; 2 pol; elec.	8MV 376 758-511	503 Clutch, radiator fan				
				Depth [mm]: 119; Ø 236 mm; Number of mounting bores: 6; 2 pol; elec.	8MV 376 758-541	504 Clutch, radiator fan				
				Bore Ø [mm]: 152; Depth [mm]: 114; Ø 190 mm	8MV 376 758-551	504 Clutch, radiator fan				
				Bore Ø [mm]: 152; Diameter 1 [mm]: 704; Diameter 2 [mm]: 127; Number of Fan Blades: 9; Number of mounting bores: 6	8MV 376 758-561	507 Fan Wheel, engine cooling				
				Bore Ø [mm]: 200; Diameter 1 [mm]: 750; Diameter 2 [mm]: 180; Number of Fan Blades: 9	8MV 376 758-571	508 Fan Wheel, engine cooling				
				33.463 DFAS	338 kW		01/94→	Depth [mm]: 42; L 1,065 mm; Mounting Bores Distance [mm]: 400; Vers. produced by BEHR; W 708 mm	8MK 376 721-461	509 Radiator, engine cooling
								Depth [mm]: 40; L 945 mm; Mounting Bores Distance [mm]: 400; Vers. produced by BEHR; W 708 mm	8MK 376 721-481	510 Radiator, engine cooling
Depth [mm]: 42; L 945 mm; Mounting Bores Distance [mm]: 520; Vers. produced by BEHR; W 708 mm	8MK 376 721-761	511 Radiator, engine cooling								
Ø 203 mm; Thermic; Vers. produced by BEHR	8MV 376 731-281	500 Clutch, radiator fan								
Ø 704 mm; Number of Fan Blades: 8; Vers. produced by BEHR	8MV 376 733-131	506 Fan Wheel, engine cooling								
Ø 290 mm	8MV 376 757-221	500 Clutch, radiator fan								
Ø 753 mm; Number of Fan Blades: 9	8MV 376 757-271	505 Fan, radiator								
Bore Ø [mm]: 200; Depth [mm]: 138; Ø 236 mm; Number of mounting bores: 6; 2 pol; elec.	8MV 376 758-511	503 Clutch, radiator fan								
Depth [mm]: 119; Ø 236 mm; Number of mounting bores: 6; 2 pol; elec.	8MV 376 758-541	504 Clutch, radiator fan								
Bore Ø [mm]: 152; Depth [mm]: 114; Ø 190 mm	8MV 376 758-551	504 Clutch, radiator fan								
Bore Ø [mm]: 152; Diameter 1 [mm]: 704; Diameter 2 [mm]: 127; Number of Fan Blades: 9; Number of mounting bores: 6	8MV 376 758-561	507 Fan Wheel, engine cooling								
Bore Ø [mm]: 200; Diameter 1 [mm]: 750; Diameter 2 [mm]: 180; Number of Fan Blades: 9	8MV 376 758-571	508 Fan Wheel, engine cooling								
35.343 VFC 35.343 VFK 41.343 VFC 41.343 VFK	250 kW 250 kW 250 kW 250 kW		08/95→ 08/95→ 08/95→ 08/95→					Manual Transmission; for vehicles without air conditioning; Capacity [Litre]: 8; Transparent; Depth [mm]: 108; L 743 mm; Vers. produced by BEHR; W 321 mm	8MA 376 705-331	521 Expansion Tank, coolant
								Manual Transmission; for vehicles without air conditioning; Capacity [Litre]: 14; Black; Depth [mm]: 142; L 743 mm; Vers. produced by BEHR; W 321 mm	8MA 376 705-381	522 Expansion Tank, coolant
				Depth [mm]: 40; L 945 mm; Mounting Bores Distance [mm]: 400; Vers. produced by BEHR; W 708 mm	8MK 376 721-481	510 Radiator, engine cooling				
				Depth [mm]: 42; L 845 mm; Vers. produced by BEHR; W 938 mm	8MK 376 728-661	513 Radiator, engine cooling				
				Ø 203 mm; Thermic; Vers. produced by BEHR	8MV 376 731-281	500 Clutch, radiator fan				
				Ø 704 mm; Number of Fan Blades: 8; Vers. produced by BEHR	8MV 376 733-131	506 Fan Wheel, engine cooling				
				Ø 290 mm	8MV 376 757-221	500 Clutch, radiator fan				
				Bore Ø [mm]: 152; Diameter 1 [mm]: 704; Diameter 2 [mm]: 127; Number of Fan Blades: 9; Number of mounting bores: 6	8MV 376 758-561	507 Fan Wheel, engine cooling				
				Bore Ø [mm]: 200; Diameter 1 [mm]: 750; Diameter 2 [mm]: 180; Number of Fan Blades: 9	8MV 376 758-571	508 Fan Wheel, engine cooling				

Manufacturer - Model	Power	Displ.	Year of Constr.	Remark	Part Number	Page
MAN - F 2000						01/94→
37.414 VFA	301 kW		06/98→	Depth [mm]: 40; L 945 mm; Mounting Bores Distance [mm]: 400; Vers. produced by BEHR; W 708 mm	8MK 376 721-481	510 Radiator, engine cooling
				Depth [mm]: 42; L 945 mm; Mounting Bores Distance [mm]: 520; Vers. produced by BEHR; W 708 mm	8MK 376 721-761	511 Radiator, engine cooling
				Ø 290 mm	8MV 376 757-221	500 Clutch, radiator fan
				Ø 753 mm; Number of Fan Blades: 9	8MV 376 757-271	505 Fan, radiator
				Bore Ø [mm]: 152; Depth [mm]: 128; Ø 190 mm; Number of mounting bores: 6; 2 pol; elec.	8MV 376 758-471	502 Clutch, radiator fan
				Bore Ø [mm]: 200; Depth [mm]: 138; Ø 236 mm; Number of mounting bores: 6; 2 pol; elec.	8MV 376 758-511	503 Clutch, radiator fan
				Bore Ø [mm]: 152; Depth [mm]: 114; Ø 190 mm	8MV 376 758-551	504 Clutch, radiator fan
				Bore Ø [mm]: 152; Diameter 1 [mm]: 704; Diameter 2 [mm]: 127; Number of Fan Blades: 9; Number of mounting bores: 6	8MV 376 758-561	507 Fan Wheel, engine cooling
37.464 VFA 40.463 DFK	338 kW 338 kW		06/98→ 01/94→	Depth [mm]: 40; L 945 mm; Mounting Bores Distance [mm]: 400; Vers. produced by BEHR; W 708 mm	8MK 376 721-481	510 Radiator, engine cooling
				Depth [mm]: 42; L 945 mm; Mounting Bores Distance [mm]: 520; Vers. produced by BEHR; W 708 mm	8MK 376 721-761	511 Radiator, engine cooling
				Ø 290 mm	8MV 376 757-221	500 Clutch, radiator fan
				Ø 753 mm; Number of Fan Blades: 9	8MV 376 757-271	505 Fan, radiator
				Bore Ø [mm]: 200; Depth [mm]: 138; Ø 236 mm; Number of mounting bores: 6; 2 pol; elec.	8MV 376 758-511	503 Clutch, radiator fan
				Depth [mm]: 119; Ø 236 mm; Number of mounting bores: 6; 2 pol; elec.	8MV 376 758-541	504 Clutch, radiator fan
				Bore Ø [mm]: 152; Depth [mm]: 114; Ø 190 mm	8MV 376 758-551	504 Clutch, radiator fan
				Bore Ø [mm]: 152; Diameter 1 [mm]: 704; Diameter 2 [mm]: 127; Number of Fan Blades: 9; Number of mounting bores: 6	8MV 376 758-561	507 Fan Wheel, engine cooling
40.273 DFAK	198 kW		01/94→	Depth [mm]: 42; L 1,065 mm; Mounting Bores Distance [mm]: 400; Vers. produced by BEHR; W 708 mm	8MK 376 721-461	509 Radiator, engine cooling
				Depth [mm]: 40; L 945 mm; Mounting Bores Distance [mm]: 400; Vers. produced by BEHR; W 708 mm	8MK 376 721-481	510 Radiator, engine cooling
				Depth [mm]: 42; L 945 mm; Mounting Bores Distance [mm]: 520; Vers. produced by BEHR; W 708 mm	8MK 376 721-761	511 Radiator, engine cooling
				Ø 704 mm; Number of Fan Blades: 8; Vers. produced by BEHR	8MV 376 733-131	506 Fan Wheel, engine cooling
				Ø 290 mm	8MV 376 757-221	500 Clutch, radiator fan
				Bore Ø [mm]: 152; Depth [mm]: 114; Ø 190 mm	8MV 376 758-551	504 Clutch, radiator fan
				Bore Ø [mm]: 152; Diameter 1 [mm]: 704; Diameter 2 [mm]: 127; Number of Fan Blades: 9; Number of mounting bores: 6	8MV 376 758-561	507 Fan Wheel, engine cooling
				Bore Ø [mm]: 200; Diameter 1 [mm]: 750; Diameter 2 [mm]: 180; Number of Fan Blades: 9	8MV 376 758-571	508 Fan Wheel, engine cooling
40.273 DFK	198 kW		01/94→	Depth [mm]: 40; L 945 mm; Mounting Bores Distance [mm]: 400; Vers. produced by BEHR; W 708 mm	8MK 376 721-481	510 Radiator, engine cooling
				Depth [mm]: 42; L 945 mm; Mounting Bores Distance [mm]: 520; Vers. produced by BEHR; W 708 mm	8MK 376 721-761	511 Radiator, engine cooling
				Ø 704 mm; Number of Fan Blades: 8; Vers. produced by BEHR	8MV 376 733-131	506 Fan Wheel, engine cooling
				Ø 290 mm	8MV 376 757-221	500 Clutch, radiator fan
				Bore Ø [mm]: 152; Depth [mm]: 114; Ø 190 mm	8MV 376 758-551	504 Clutch, radiator fan
				Bore Ø [mm]: 152; Diameter 1 [mm]: 704; Diameter 2 [mm]: 127; Number of Fan Blades: 9; Number of mounting bores: 6	8MV 376 758-561	507 Fan Wheel, engine cooling
Bore Ø [mm]: 200; Diameter 1 [mm]: 750; Diameter 2 [mm]: 180; Number of Fan Blades: 9	8MV 376 758-571	508 Fan Wheel, engine cooling				

Manufacturer - Model	Power	Displ.	Year of Constr.	Remark	Part Number	Page
MAN - F 2000						01/94→
40.463 DFS	338 kW		01/94→	Ø 290 mm	8MV 376 757-221 Clutch, radiator fan	500
				Ø 753 mm; Number of Fan Blades: 9	8MV 376 757-271 Fan, radiator	505
				Bore Ø [mm]: 200; Depth [mm]: 138; Ø 236 mm; Number of mounting bores: 6; 2 pol; elec.	8MV 376 758-511 Clutch, radiator fan	503
				Depth [mm]: 119; Ø 236 mm; Number of mounting bores: 6; 2 pol; elec.	8MV 376 758-541 Clutch, radiator fan	504
				Bore Ø [mm]: 152; Depth [mm]: 114; Ø 190 mm	8MV 376 758-551 Clutch, radiator fan	504
				Bore Ø [mm]: 152; Diameter 1 [mm]: 704; Diameter 2 [mm]: 127; Number of Fan Blades: 9; Number of mounting bores: 6	8MV 376 758-561 Fan Wheel, engine cooling	507
				Bore Ø [mm]: 200; Diameter 1 [mm]: 750; Diameter 2 [mm]: 180; Number of Fan Blades: 9	8MV 376 758-571 Fan Wheel, engine cooling	508
MAN - FOCL						
12.240	176 kW			Depth [mm]: 40; L 705 mm; Vers. produced by BEHR; W 608 mm	8MK 376 730-621 Radiator, engine cooling	514
12.250	184 kW					
MAN - HOCL						08/93→
12.240 HOCL-NL	176 kW			Ø 720 mm; Vers. produced by BEHR	8MV 376 757-421 Fan Wheel, engine cooling	506
14.240 HOCL-NL	176 kW					
14.280 HOCL	206 kW					
14.290 HOCL-NL	213 kW					
18.240 HOCL-NL	176 kW					
18.250 HOCL-NL, HOCL-SKD(SL)	184 kW		08/93→05/01			
18.280 HOCL-NL	206 kW		05/02→08/08			
18.290 HOCL-NL	213 kW					
18.310 HOCL-NL	228 kW					
18.320 HOCL-NL	235 kW					
MAN - L 2000						10/93→
10.145 LC,10.145 LLC, LRC, LLRC (LE140C)	103 kW		09/00→		8MK 376 774-441 Radiator, engine cooling	519
10.145 LK, LRK, L-KI, LR-KI (LE140C)	103 kW		09/00→	Ø 165 mm; + OE 51066300071	8MV 376 757-681 Clutch, radiator fan	501
10.145 LLS, LLRS (LE140C)	103 kW		09/00→			
10.185 LAC, LAEC, LARC, LAERC, LA-LA, LAE-LF (LE180C)	132 kW		09/00→	Ø 600 mm; + OE 51066010266; Number of Fan Blades: 8	8MV 376 757-731 Fan Wheel, engine cooling	507
10.185 LAK, LAEK, LARK, LAERK (LE180C)	132 kW		09/00→			
10.185 LC,10.185 LLC, LRC, LLRC (LE180C)	132 kW		09/00→			
10.185 LK, LRK, L-KI, LR-KI (LE180C)	132 kW		09/00→			
10.185 LLS, LLRS (LE180C)	132 kW		09/00→			
10.220 FOC,10.220 FOCL	162 kW		02/95→			
10.223 LAEC	162 kW		01/95→06/96			
10.223 LC,10.223 LLC	162 - 169 kW		10/93→06/96			
10.223 LK	162 - 169 kW		10/93→06/96			
10.223 LLS	162 - 169 kW		10/93→06/96			
10.224 LAC, LAEC, LARC, LAERC	162 kW		01/95→			
10.224 LAK, LAEK, LARK, LAERK	162 kW		01/95→			
10.224 LC,10.224 LLC, LRC, LLRC	162 kW		05/94→			
10.224 LK, LRK, L-KI, LR-KI	162 kW		05/94→			
10.224 LLS, LLRS	162 kW		05/94→			
8.145 LC,8.145 LLC, L-LF (LE140C)	103 kW		09/00→			
8.145 LLS, LLRS (LE140C)	103 kW		09/00→			
8.145 LRK, L-KI, LR-KILK (LE140C)	103 kW		09/00→			
8.185 LC,8.185 LLC, LRC, LLRC, L-LF (LE180C)	132 kW		09/00→			
8.185 LK, LRK, L-KI, LR-KI (LE180C)	132 kW		09/00→			
8.185 LLS, LLRS (LE180C)	132 kW		09/00→			
8.220 FOC,8.220 FOCL	162 kW		04/95→			
8.223 LAEC	162 kW		01/95→06/96			
8.223 LC,8.223 LLC	162 - 169 kW		10/93→06/96			
8.223 LK	162 - 169 kW		10/93→06/96			
8.223 LLS	162 - 169 kW		10/93→06/96			
8.224 LAC, LAEC, LARC, LAERC	162 kW		01/95→			
8.224 LAK, LAEK, LARK, LAERK	162 kW		01/95→			

Manufacturer - Model	Power	Displ.	Year of Constr.	Remark	Part Number	Page
MAN - L 2000						10/93→
8.224 LC,8.224 LLC, LRC, LLRC	162 kW		05/94→		8MK 376 774-441	519
8.224 LK, LRK, L-KI, LR-KI	162 kW		05/94→		Radiator, engine cooling	
8.224 LLS, LLRS	162 kW		05/94→	Ø 165 mm; + OE 51066300071	8MV 376 757-681	501
8.225 LC,8.225 LLC, LRC, LLRC (LE220C)	162 kW		09/00→		Clutch, radiator fan	
9.145 LC,9.145 LLC, LRC, LLRC (LE140C)	103 kW		09/00→	Ø 600 mm; + OE 51066010266; Number of Fan Blades: 8	8MV 376 757-731	507
9.145 LK, LRK, L-KI, LR-KI (LE140C)	103 kW		09/00→		Fan Wheel, engine cooling	
9.145 LLS, LLRS (LE140C)	103 kW		09/00→			
9.185 LC,9.185 LLC, LRC, LLRC (LE180C)	132 kW		09/00→			
9.185 LK, LRK, L-KI, LR-KI (LE180C)	132 kW		09/00→			
9.185 LLS, LLRS (LE 180C)	132 kW		09/00→			
9.223 LC,9.223 LLC	162 - 169 kW		10/93→06/96			
9.223 LK	162 - 169 kW		10/93→06/96			
9.223 LLS	162 - 169 kW		10/93→06/96			
9.224 LC,9.224 LLC, LRC, LLRC	162 kW		05/94→			
9.224 LK, LRK, L-KI, LR-KI	162 kW		05/94→			
9.224 LLS, LLRS	162 kW		05/94→			
10.153 LAEK	114 kW		10/93→06/96		8MK 376 774-441	519
10.153 LC,10.153 LLC	114 kW		10/93→06/96		Radiator, engine cooling	
10.153 LK	114 kW		10/93→06/96			
10.153 LLS	114 kW		10/93→06/96			
10.155 LK, LRK	114 kW		02/04→			
10.163 LAC, LAEC, LARC, LAERC	114 - 118 kW		05/94→			
10.163 LAK, LAEK, LARK, LAERK	114 - 118 kW		01/95→			
10.163 LC,10.163 LLC	114 - 118 kW		05/94→			
10.163 LC,10.163 LLC, LRC, LLRC (LE160C)	114 kW		09/00→			
10.163 LK, LRK, L-KI, LR-KI	114 - 118 kW		05/94→			
10.163 LLS, LLRS	114 - 118 kW		05/94→			
10.225 LAC, LAEC, LARC, LAERC, LA-LF, LAE-LF (LE220C)	162 kW		09/00→			
10.225 LAK, LAEK, LARK, LAERK (LE220C)	162 kW		09/00→			
10.225 LC, 10.225 LLC, LRC, LLRC	162 kW		09/00→			
10.225 LC, 10.225 LLC, LRC, LLRC (LE220C)	162 kW		09/00→			
10.225 LK, LRK, L-KI, LR-KI(LE220C)	162 kW		09/00→			
10.225 LLS, LLRS (LE220C)	162 kW		09/00→			
12.225 LC, LLC (LE220C)	162 kW		09/99→			
8.103 LC, 8.103 LLC	75 kW		10/93→06/96			
8.103 LK	75 kW		10/93→06/96			
8.113 LC, 8.113 LLC	81 kW		08/95→			
8.113 LC,8.113 LLC, LRC, LLRC, (LE110C)	83 kW		09/00→			
8.113 LK, LRK, L-KI, LR-KI	81 kW		08/95→			
8.153 LC,8.153 LLC	114 kW		10/93→07/97			
8.153 LK	114 kW		10/93→07/97			
8.153 LLS	114 kW		10/93→06/96			
8.155 L, LR, LC, LLC, LRC, LLRC, L-LF	114 kW		02/04→			
8.155 LK, LRK	114 kW		02/04→			
8.155 LLS, LLRS	114 kW		02/04→			
8.163 LC,8.163 LLC	114 - 118 kW		05/94→			
8.163 LC,8.163 LLC, LRC, LLRC, L-LF	104 kW		08/95→			
8.163 LC, 8.163 LLC (LE160C)	114 kW		09/00→			
8.163 LK, LRK, L-KI, LR-KI	114 - 118 kW		05/94→			
8.163 LLS, LLRS	114 - 118 kW		05/94→			
8.225 LAC, LAEC, LARC, LAERC (LE220C)	162 kW		09/00→			
8.225 LAK, LAEK, LARK, LAERK (LE220C)	162 kW		09/00→			
8.225 LK, LRK, L-KI, LR-KI (LE220C)	162 kW		09/00→			
8.225 LLS, LLRS (LE220C)	162 kW		09/00→			
9.153 LC,9.153 LLC	114 kW		10/93→06/96			
9.153 LK	114 kW		10/93→06/96			
9.153 LLS	114 kW		10/93→12/95			
9.155 L, LC, LLC, LRC, LLRC	114 kW		02/04→			
9.155 LK, LRK	114 kW		02/04→			
9.155 LLS, LLRS	114 kW		02/04→			
9.163 LC	104 kW		08/95→03/97			

Manufacturer - Model	Power	Displ.	Year of Constr.	Remark	Part Number	Page
MAN - L 2000						10/93→
9.163 LC,9.163 LLC, LRC, LLRC	114 - 118 kW		05/94→		8MK 376 774-441 Radiator, engine cooling	519
9.163 LK	104 kW		08/95→03/97			
9.163 LK, LRK, L-KI, LR-KI	114 - 118 kW		05/94→			
9.163 LLS, LLRS	114 - 118 kW		05/94→			
9.225 LC,9.225 LLC, LRC, LLRC (LE220C)	162 kW		09/00→			
9.225 LK, LRK, L-KI, LR-KI (LE220C)	162 kW		09/00→			
9.225 LLS, LLRS (LE220C)	162 kW		09/00→			
12.185 LC, LLC (LE180C)	132 kW		09/99→	∅ 165 mm; + OE 51066300071	8MV 376 757-681	501
8.185 LAC, LAEC, LARC, LAERC, LA-LF, LAE-LF (LE180C)	132 kW		09/00→	∅ 600 mm; + OE 51066010266; Number of Fan Blades: 8	8MV 376 757-731 Fan Wheel, engine cooling	507
8.185 LAK, LAEK, LARK, LAERK (LE180C)	132 kW		09/00→			
MAN - LION S CITY						06/96→
A 20	191 kW		07/98→	Depth [mm]: 52; L 810 mm; without frame; Vers. produced by BEHR; W 708 mm	8MK 376 722-241 Radiator, engine cooling	512
A 21	184 kW		06/96→			
A 23	191 kW		08/96→			
				∅ 753 mm; Number of Fan Blades: 9	8MV 376 757-271 Fan, radiator	505
A 22	206 kW		10/09→	Depth [mm]: 42; L 1,067 mm; Vers. produced by BEHR; W 748 mm	8MK 376 755-421 Radiator, engine cooling	516
A 22	235 kW		10/09→			
				∅ 753 mm; Number of Fan Blades: 9	8MV 376 757-271 Fan, radiator	505
A 22	265 kW		10/09→	∅ 753 mm; Number of Fan Blades: 9	8MV 376 757-271 Fan, radiator	505
A 35	184 kW		10/09→	Depth [mm]: 52; L 810 mm; Vers. produced by BEHR; W 708 mm	8MK 376 755-441 Radiator, engine cooling	517
A 35	213 kW		10/09→			
A 66	184 kW		02/09→	∅ 753 mm; Number of Fan Blades: 9	8MV 376 757-271 Fan, radiator	505
A 66	213 kW		02/09→			
MAN - LION S COACH						09/95→
FRH 352,RH 353	257 kW		09/95→	Depth [mm]: 42; L 938 mm; Vers. produced by BEHR; W 920 mm	8MK 376 722-401 Radiator, engine cooling	512
FRH 402,RH 403	294 kW		09/95→			
RH 402	294 kW		09/98→	Depth [mm]: 42; L 938 mm; without frame; Vers. produced by BEHR; W 920 mm	8MK 376 737-041 Radiator, engine cooling	514
RH 413	301 kW		01/00→			
					8MK 376 774-501 Radiator, engine cooling	519
				∅ 753 mm; Number of Fan Blades: 9	8MV 376 757-271 Fan, radiator	505
RH 463, RHC 464	338 kW		01/00→	Depth [mm]: 42; L 938 mm; Vers. produced by BEHR; W 920 mm	8MK 376 722-401 Radiator, engine cooling	512
				Depth [mm]: 42; L 938 mm; without frame; Vers. produced by BEHR; W 920 mm	8MK 376 737-041 Radiator, engine cooling	514
				Depth [mm]: 40; L 1,066 mm; Vers. produced by BEHR; W 938 mm	8MK 376 755-431 Radiator, engine cooling	516
					8MK 376 774-501 Radiator, engine cooling	519
				∅ 753 mm; Number of Fan Blades: 9	8MV 376 757-271 Fan, radiator	505
RHC 414	301 kW		06/02→	Depth [mm]: 42; L 938 mm; Vers. produced by BEHR; W 920 mm	8MK 376 722-401 Radiator, engine cooling	512
				Depth [mm]: 42; L 938 mm; without frame; Vers. produced by BEHR; W 920 mm	8MK 376 737-041 Radiator, engine cooling	514
					8MK 376 774-501 Radiator, engine cooling	519
					8MV 376 757-271 Fan, radiator	505
MAN - LION S COMFORT						09/96→
RN 313	228 kW		09/96→		8MK 376 774-501 Radiator, engine cooling	519
RN 353	257 kW		06/97→			
MAN - LION S STAR						01/93→
FRH 352,RH 353	257 kW		09/95→	Depth [mm]: 42; L 938 mm; Vers. produced by BEHR; W 920 mm	8MK 376 722-401 Radiator, engine cooling	512
FRH 402,RH 403	294 kW		09/95→			
RH 464, RHS 464	301 kW		03/00→	Depth [mm]: 42; L 938 mm; without frame; Vers. produced by BEHR; W 920 mm	8MK 376 737-041 Radiator, engine cooling	514
RH 464, RHS 464	301 kW		01/02→			
					8MK 376 774-501 Radiator, engine cooling	519
				∅ 753 mm; Number of Fan Blades: 9	8MV 376 757-271 Fan, radiator	505

Manufacturer - Model	Power	Displ.	Year of Constr.	Remark	Part Number	Page
MAN - LION S STAR						01/93→
FRH 422	309 kW		01/93→09/96	Depth [mm]: 42; L 938 mm; Vers. produced by BEHR; W 920 mm	8MK 376 722-401 Radiator, engine cooling	512
				Depth [mm]: 42; L 938 mm; without frame; Vers. produced by BEHR; W 920 mm	8MK 376 737-041 Radiator, engine cooling	514
				Ø 753 mm; Number of Fan Blades: 9	8MV 376 757-271 Fan, radiator	505
RH 414 RH 464, RHS 464	338 kW 338 kW		03/00→ 01/02→	Depth [mm]: 42; L 938 mm; Vers. produced by BEHR; W 920 mm	8MK 376 722-401 Radiator, engine cooling	512
				Depth [mm]: 42; L 938 mm; without frame; Vers. produced by BEHR; W 920 mm	8MK 376 737-041 Radiator, engine cooling	514
				Depth [mm]: 40; L 1,066 mm; Vers. produced by BEHR; W 938 mm	8MK 376 755-431 Radiator, engine cooling	516
					8MK 376 774-501 Radiator, engine cooling	519
				Ø 753 mm; Number of Fan Blades: 9	8MV 376 757-271 Fan, radiator	505
MAN - M 90						08/88→06/96
12.152 F, 12.152 FL 12.152 FK 12.192 F, 12.192 FL 12.192 FA 12.192 FAK 12.192 FK 12.192 FS, 12.192 FLS 12.222 F, 12.222 FL 12.222 FA 12.222 FAK 12.222 FK 12.222 FLS 12.232 F, 12.232 FL 12.232 FA 12.232 FK 12.232 FS, 12.232 FLS 12.262 F, 12.262 FL 12.262 FK 12.262 FS, 12.262 FLS 12.272 F, 12.272 FL 12.272 FA 12.272 FAK 12.272 FK 12.272 FS, 12.272 FLS 14.152 F, 14.152 FL 14.152 F, 14.152 FL 14.152 FK 14.152 FK 14.152 FS, 14.152 FLS 14.152 FS, 14.152 FLS 14.162 F, 14.162 FL 14.162 FK 14.162 FS, 14.162 FLS 14.192 F, 14.192 FL 14.192 FK 14.192 FS, 14.192 FLS 14.222 F, 14.222 FL 14.222 FK 14.222 FLS 14.232 F, 14.232 FL 14.232 F, 14.232 FL 14.232 FK 14.232 FS, 14.232 FLS 14.232 FS, 14.232 FLS 14.262 F, 14.262 FL 14.262 FK 14.262 FS, 14.262 FLS 14.272 F, 14.272 FL 14.272 FK 14.272 FS, 14.272 FLS 17.192 F, 17.192 FL 17.192 FA 17.192 FAK 17.192 FK 17.192 FS, 17.192 FLS 17.222 FA 17.222 FAK 17.232 F, 17.232 FL 17.232 F, 17.232 FL 17.232 FA 17.232 FA	110 - 114 kW 110 - 114 kW 140 kW 140 kW 140 kW 140 kW 140 kW 162 kW 162 kW 162 kW 162 kW 162 kW 169 kW 169 kW 169 kW 169 kW 169 kW 191 kW 191 kW 191 kW 198 kW 198 kW 198 kW 198 kW 198 kW 198 kW 198 kW 110 - 114 kW 114 kW 110 - 114 kW 114 kW 110 - 114 kW 114 kW 114 kW 118 kW 118 kW 118 kW 118 kW 140 kW 140 kW 140 kW 162 kW 162 kW 162 kW 160 kW 169 kW 169 kW 160 kW 169 kW 169 kW 191 kW 191 kW 191 kW 198 kW 198 kW 198 kW 140 kW 140 kW 140 kW 140 kW 140 kW 162 kW 162 kW 160 kW 169 kW 169 kW 160 kW 169 kW 169 kW 160 kW 169 kW 160 kW 169 kW 160 kW 169 kW 160 kW 169 kW		12/88→05/94 12/88→05/94 07/90→06/96 10/92→06/96 10/92→06/96 07/90→06/96 07/90→06/96 05/94→06/96 05/94→06/96 05/94→06/96 05/94→06/96 05/94→06/96 05/94→06/96 08/88→06/96 05/90→06/96 08/88→06/96 08/88→06/96 08/95→06/96 08/95→06/96 08/95→06/96 10/92→06/96 10/93→04/95 10/93→04/95 10/92→06/96 10/92→06/96 12/88→04/94 05/94→06/96 12/88→05/94 05/94→06/96 12/88→05/94 05/94→06/96 08/95→06/96 08/95→06/96 08/95→06/96 07/90→06/96 07/90→06/96 07/90→06/96 05/94→06/96 05/94→06/96 05/94→06/96 05/90→04/95 08/88→06/96 08/88→06/96 05/90→04/95 08/88→06/96 08/88→06/96 08/95→06/96 08/95→06/96 08/95→06/96 10/92→06/96 10/92→06/96 12/92→06/96 07/90→04/95 07/90→06/96 07/90→06/96 07/90→01/91 07/90→04/95 05/94→06/96 05/94→06/96 05/90→04/95 08/88→04/95 05/90→04/95 02/89→06/96	Ø 187 mm; + OE 51066300067	8MV 376 757-671 Clutch, radiator fan	501

Manufacturer - Model	Power	Displ.	Year of Constr.	Remark	Part Number	Page			
MAN - M 90						08/88→06/96			
17.232 FAK	160 kW		05/90→04/95	Ø 187 mm; + OE 51066300067	8MV 376 757-671 Clutch, radiator fan	501			
17.232 FAK	169 kW		02/89→06/96						
17.232 FK	160 kW		05/90→01/91						
17.232 FK	169 kW		08/88→01/91						
17.232 FS,17.232 FLS	160 kW		05/90→04/95						
17.272 FLS	198 kW		10/92→05/95						
18.192 F,18.192 FL,18.192 FLL	140 kW		09/90→06/96						
18.192 FK	140 kW		09/90→06/96						
18.222 F,18.222 FL,18.222 FLL	162 kW		05/94→06/96						
18.222 FK	162 kW		05/94→06/96						
18.232 F,18.232 FL,18.232 FLL	169 kW		09/90→06/96						
18.232 FK	169 kW		09/90→06/96						
18.262 F,18.262 FL,18.262 FLL	191 kW		08/95→06/96						
18.262 FK	191 kW		08/95→06/96						
18.272 F,18.272 FL,18.272 FLL	198 kW		10/92→06/96						
18.272 FK	198 kW		10/92→06/96						
24.192 FNL,24.192 FNLL,24.192 FVL	140 kW		07/89→06/96						
24.222 FNL,24.222 FNLL,24.222 FVL	162 kW		05/94→06/96						
24.232 FNL	160 kW		05/90→04/95						
24.232 FNL,24.232 FNLL,24.232 FVL	169 kW		07/89→06/96						
24.262 FNL,24.262 FNLL,24.262 FVL	191 kW		08/95→06/96						
24.272 FNL,24.272 FNLL,24.272 FVL	198 kW		10/92→06/96						
MAN - M 2000 L									08/95→
12.185 LC, LLC, LRC, LLRC	132 - 136 kW		05/01→				Ø 165 mm; + OE 51066300071	8MV 376 757-681	501
								Clutch, radiator fan	
							Ø 600 mm; + OE 51066010266; Number of Fan Blades: 8	8MV 376 757-731 Fan	507
								Wheel, engine cooling	
12.224, 12.225, LK, LRK	162 kW		08/95→					8MK 376 774-441	519
12.224 LC, LLC, LRC, LLRC	162 kW		08/95→					Radiator, engine cooling	
14.224 LAC, LARC	162 kW		08/95→				Ø 165 mm; + OE 51066300071	8MV 376 757-681	501
14.224 LAK, LARK	162 kW		08/95→						
14.224 LC, LLC, LLLC, LRC, LLRC, LLLRC	162 kW		08/95→				Ø 600 mm; + OE 51066010266; Number of Fan Blades: 8	8MV 376 757-731 Fan	507
14.224 LK, LRK	162 kW		08/95→						
14.263, 14.264 LAC, LARC	191 kW		08/95→		Wheel, engine cooling				
14.263, 14.264 LAK, LARK	191 kW		08/95→						
14.263, 14.264 LC, LLC, LLLC, LRC, LLRC, LLLRC	191 kW		08/95→						
14.263, 14.264 LK, LRK	191 kW		08/95→						
15.224 LC, LLC, LLLC, LRC, LLRC, LLLRC	162 kW		08/95→						
15.224 LK, LRK	162 kW		08/95→						
15.263, 15.264 LC, LLC, LLLC, LRC, LLRC, LLLRC	191 kW		08/95→						
15.263, 15.264 LK, LRK	191 kW		08/95→						
18.224, 18.225, LAC, LARC	162 kW		08/95→						
18.224, 18.225, LAK, LARK	162 kW		08/95→						
18.224, 18.225, LC, LLC, LLLC, LRC, LLRC, LLLRC	162 kW		08/95→						
18.224, 18.225, LK, LK, LRK, LLRK	162 kW		08/95→						
18.263, 18.264, LAC, LARC	191 kW		08/95→						
18.263, 18.264, LAK, LARK	191 kW		08/95→						
18.263, 18.264, LC, LLC, LLLC, LRC, LLRC, LLLRC	191 kW		08/95→						
18.263, 18.264, LK, LK, LRK, LLRK	191 kW		08/95→						
12.225 LC, LLC, LLLC, LRC, LLRC	162 kW		05/01→		8MK 376 774-441	519			
12.255 LC, LLC, LLLC	180 kW		08/02→		Radiator, engine cooling				
12.255 LK	180 kW		10/03→						
12.285 LC, LLC, LLLC	206 kW		08/02→						
12.285 LK	206 kW		10/03→						
14.224, 14.225, LA-LF	162 kW		07/03→						
14.225 LAC, LARC, (LE220B)	162 kW		09/00→						
14.225 LAK, LARK, (LE220B)	162 kW		09/00→						
14.225 LC, LLC, LLLC, LRC, LLRC, LLLRC, (LE220B)	162 kW		09/00→						
14.225 LK, LRK (LE220B)	162 kW		09/00→						
14.255 LAC, LARC	180 kW		11/02→						
14.255 LAK, LARK	180 kW		11/02→						
14.255 LA-LF	180 kW		07/03→						
14.255 LC, LLC, LLLC, LRC, LLRC, LLLRC, (LE250B)	180 kW		09/00→						

Manufacturer - Model	Power	Displ.	Year of Constr.	Remark	Part Number	Page
MAN - M 2000 L						08/95→
14.255 LK, LRK	180 kW		11/02→		8MK 376 774-441 Radiator, engine cooling	519
14.264 LA-LF	191 kW		07/03→			
14.285 LC, LLC, LLLC, LRC, LLRC, LLLRC, (LE280B)	206 kW		09/00→			
15.163 LC, LLC, LRC	114 kW		08/95→			
15.163 LK, LRK	114 kW		08/95→			
15.185 LC, LRC	132 - 136 kW		05/01→			
15.185 LK, LRK	132 - 136 kW		11/02→			
15.225 LC, LLC, LLLC, LRC, LLRC, LLLRC, (LE220B)	162 kW		09/99→			
15.225 LK, LRK, (LE220B)	162 kW		09/99→			
15.255 LC, LLC, LLLC, LRC, LLRC, LLLRC, (LE250B)	180 kW		09/99→			
15.255 LK, LRK, (LE250B)	180 kW		09/99→			
15.285 LC, LLC, LLLC, LRC, LLRC, LLLRC, (LE280B)	206 kW		09/99→			
15.285 LK, LRK, (LE280B)	206 kW		09/99→			
18.224, 18.225, L-KO, LR-KO	162 kW		05/01→			
18.255 LAC, LARC	180 kW		05/01→			
18.255 LAK, LARK	180 kW		05/01→			
18.255 LC, LLC, LLLC, LRC, LLRC, LLLRC, (LE250B)	180 kW		09/99→			
18.255 LK, LK, LRK, LRRK	180 kW		11/02→			
18.255 L-KO, LR-KO	180 kW		05/01→			
18.263, 18.264, L-KO, LR-KO	191 kW		05/01→			
18.285 LAC, LARC (LE280B)	206 kW		09/99→			
18.285 LAK, LARK, (LE280B)	206 kW		09/99→			
18.285 LC, LLC, LLLC, LRC, LLRC, LLLRC, (LE280B)	206 kW		09/99→			
19.224, 19.225, LLC	162 kW		05/01→			
19.255 LLC	180 kW		05/01→			
19.264 LLC	191 kW		05/01→			
19.284, 19.285, LLC	206 kW		05/01→			
20.224 LNLC, LNLLC	162 kW		05/01→			
20.255 LNLC, LNLLC	180 kW		05/01→			
20.264 LNLC, LNLLC	191 kW		05/01→			
20.284, 20.285, LNLC, LNLLC	206 kW		05/01→			
26.224, 26.225, DL-HK, DLR-HK	180 kW		11/02→			
26.255 DL-HK, DLR-HK	180 kW		11/02→			
26.284, 26.285, DL-HK, DLR-HK	206 kW		11/02→			
26.284 DL-TM, DLR-TM	206 kW		05/01→			
MAN - M 2000 M						08/95→
14.224 MAK	162 kW		08/95→12/05	Capacity [Litre]: 5.6; Natural; Depth [mm]: 130; L 742 mm; Vers. ohne Gewindebuchse / Vers. produced by BEHR; W 321 mm	8MA 376 705-251 Expansion Tank, coolant	521
14.224 MC, MLC, MLLC	162 kW		08/95→12/05			
14.224 MK	162 kW		08/95→12/05			
14.224 MLS, MLRS	162 kW		08/95→12/05			
14.264 MC, MLC, MLLC	191 kW		08/95→12/05			
14.264 MLS, MLRS	191 kW		08/95→12/05			
18.224 MAC, MARC	162 kW		08/95→12/05			
18.224 MAK, MARK	162 kW		08/95→12/05			
18.264 MAC, MARC	191 kW		08/95→12/05			
18.264 MAK, MARK	191 kW		08/95→12/05			
25.224 MNLC, MNLLC, MNLRC, MNLLRC, MVLC	162 kW		08/95→12/05			
25.264 MNLC, MNLLC, MNLRC, MNLLRC, MVLC	191 kW		08/95→12/05			
18.224 MC, MLC, MLLC, MRC, MLRC, MLLRC	162 kW		08/95→12/05	Capacity [Litre]: 5.6; Natural; Depth [mm]: 130; L 742 mm; Vers. ohne Gewindebuchse / Vers. produced by BEHR; W 321 mm	8MA 376 705-251 Expansion Tank, coolant	521
18.224 MK, 18.224 MLK, MRK, MLRK	162 kW		08/95→12/05			
18.224 MLS, MLRS	162 kW		08/95→12/05		8MK 376 774-441 Radiator, engine cooling	519
18.264 MC, MLC, MLLC, MRC, MLRC, MLLRC	191 kW		08/95→12/05			
18.264 MK, 18.264 MLK, MRK, MLRK	191 kW		08/95→12/05			
18.264 MLS, MLRS	191 kW		08/95→12/05			
18.225 MC, MLC, MLLC, MRC, MLRC, MLLRC	162 kW		10/00→		8MK 376 774-441 Radiator, engine cooling	519
18.255 MC, MLC, MLLC, MLRC, MLLRC	180 kW		10/00→			
18.255 MK, MLK, MRK, MLRK	180 kW		11/02→			
18.255 MLS, MLRS	180 kW		10/00→			
18.285 MC, MLC, MLLC	206 kW		06/98→12/05			
18.285 MLS, MLRS	206 kW		02/03→			
MAN - NG						08/92→
NG 262	191 kW		06/97→07/98		8MK 376 774-501 Radiator, engine cooling	519
NG 312	228 kW		09/95→07/98			

Manufacturer - Model	Power	Displ.	Year of Constr.	Remark	Part Number	Page
MAN - NG						08/92→
NG 262, NG 263 NG 312, NG 313	191 kW 228 kW		07/98→ 07/98→	Depth [mm]: 52; L 1,020 mm; Vers. produced by BEHR; W 708 mm	8MK 376 749-821 Radiator, engine cooling	515
					8MK 376 774-501 Radiator, engine cooling	519
NG 262, NG 272	191 - 198 kW		08/92→07/98	06/91→ ; Ø 650 mm; Number of Fan Blades: 8; Thermic; Vehicle Trim Level: 8060.41; Vers. produced by BEHR	8MV 376 728-131 Fan, radiator	505
NG 313 NG 323 NG 353 NG 363	228 kW 235 kW 257 kW 264 kW			Depth [mm]: 52; L 810 mm; without frame; Vers. produced by BEHR; W 708 mm	8MK 376 722-241 Radiator, engine cooling	512
				08/97→ ; Depth [mm]: 52; L 1,020 mm; Vers. produced by BEHR; W 708 mm	8MK 376 749-821 Radiator, engine cooling	515
MAN - NL						09/89→
NL 202	157 kW		09/89→04/94	06/91→ ; Ø 650 mm; Number of Fan Blades: 8; Thermic; Vehicle Trim Level: 8060.41; Vers. produced by BEHR	8MV 376 728-131 Fan, radiator	505
NL 202, NL 222, NL 223 NL 202, NL 262, NL 263	157 - 162 kW 184 kW		08/92→ 04/91→	06/96→ ; Depth [mm]: 52; L 1,020 mm; Vers. produced by BEHR; W 708 mm	8MK 376 749-821 Radiator, engine cooling	515
NL 243 NL 273	180 kW 199 kW			07/96→ ; Depth [mm]: 52; L 1,020 mm; Vers. produced by BEHR; W 708 mm	8MK 376 749-821 Radiator, engine cooling	515
NL 262 NL 312	191 kW 228 kW		06/97→ 11/95→07/98		8MK 376 774-501 Radiator, engine cooling	519
NL 262, NL 263 NL 313	191 kW 228 kW		07/98→ 07/98→	Depth [mm]: 52; L 1,020 mm; Vers. produced by BEHR; W 708 mm	8MK 376 749-821 Radiator, engine cooling	515
					8MK 376 774-501 Radiator, engine cooling	519
NL 283 NL 313 NL 323	206 kW 228 kW 235 kW			Depth [mm]: 52; L 810 mm; without frame; Vers. produced by BEHR; W 708 mm	8MK 376 722-241 Radiator, engine cooling	512
				07/96→ ; Depth [mm]: 52; L 1,020 mm; Vers. produced by BEHR; W 708 mm	8MK 376 749-821 Radiator, engine cooling	515
MAN - NM						08/87→
NM 182, NM 192 NM 222, NM 223 NM 223 NM 243 NM 253 NM 283 NM 293	130 - 140 kW 162 kW 162 kW 176 kW 184 kW 206 kW 213 kW		05/90→03/97 02/96→ 08/87→		8MK 376 774-501 Radiator, engine cooling	519
MAN - NÜ						09/96→
NÜ 263 NÜ 263 NÜ 313	191 kW 191 kW 228 kW		09/96→07/98 07/98→ 07/98→	+ OE 810610116500 ; Depth [mm]: 52; L 810 mm; without frame; Vers. produced by BEHR; W 708 mm	8MK 376 722-241 Radiator, engine cooling	512
				Depth [mm]: 52; L 1,020 mm; Vers. produced by BEHR; W 708 mm	8MK 376 749-821 Radiator, engine cooling	515
					8MK 376 774-501 Radiator, engine cooling	519
NÜ 313 15M NÜ 353 15M	228 kW 257 kW		07/98→ 07/98→		8MK 376 774-501 Radiator, engine cooling	519
MAN - SG						02/94→06/97
SG 312, SG 322	228 - 235 kW		02/94→06/97		8MK 376 774-501 Radiator, engine cooling	519
MAN - SL II						
SL 283 SL 353 SL 363	206 kW 257 kW 264 kW			Ø 720 mm; Vers. produced by BEHR	8MV 376 757-421 Fan Wheel, engine cooling	506
MAN - SM						11/87→02/95
SM 182, SM 192	130 - 140 kW		11/87→02/95		8MK 376 774-501 Radiator, engine cooling	519
MAN - SÜ						04/93→
SÜ 263 SÜ 273 SÜ 293 SÜ 313 SÜ 320 SÜ 353 SÜ 360	191 kW 198 kW 213 kW 228 kW 235 kW 257 kW 264 kW		09/03→ 09/03→	Ø 720 mm; Vers. produced by BEHR	8MV 376 757-421 Fan Wheel, engine cooling	506
SÜ 263 SÜ 272 SÜ 313 SÜ 322	265 kW 198 kW 228 kW 235 kW		09/03→ 04/93→05/95 09/03→ 05/95→06/97		8MK 376 774-501 Radiator, engine cooling	519

Manufacturer - Model	Power	Displ.	Year of Constr.	Remark	Part Number	Page
MAN - SÜ						04/93→
SÜ 283	206 kW		09/03→		8MK 376 774-501 Radiator, engine cooling	519
				Ø 720 mm; Vers. produced by BEHR	8MV 376 757-421 Fan Wheel, engine cooling	506
MAN - TGA						04/00→
18.310, 18.320 FAC, FHLC	228 - 235 kW		05/04→	Depth [mm]: 42; L 920 mm; Vers. produced by BEHR; W 938 mm	8MK 376 721-681 Radiator, engine cooling	510
				Depth [mm]: 42; L 845 mm; Vers. produced by BEHR; W 938 mm	8MK 376 728-661 Radiator, engine cooling	513
				Depth [mm]: 52; L 938 mm; Vers. produced by BEHR; W 844 mm	8MK 376 756-011 Radiator, engine cooling	518
				Depth [mm]: 52; L 938 mm; Vers. produced by BEHR; W 919 mm	8MK 376 756-021 Radiator, engine cooling	518
				Ø 270 mm; 5 ports	8MV 376 757-231 Clutch, radiator fan	500
				for tropical climates; Ø 245 mm; 2 ports	8MV 376 757-261 Clutch, radiator fan	500
				Ø 245 mm	8MV 376 757-661 Clutch, radiator fan	501
				Bore Ø [mm]: 1; Depth [mm]: 128; Ø 190 mm; Number of mounting bores: 6; 2 pol; elec.	8MV 376 758-481 Clutch, radiator fan	502
				Bore Ø [mm]: 152; Diameter 1 [mm]: 704; Diameter 2 [mm]: 127; Number of Fan Blades: 9; Number of mounting bores: 6	8MV 376 758-561 Fan Wheel, engine cooling	507
				Bore Ø [mm]: 200; Diameter 1 [mm]: 750; Diameter 2 [mm]: 180; Number of Fan Blades: 9	8MV 376 758-571 Fan Wheel, engine cooling	508
18.310, 18.320 FAK, FAK-L, FALK, FALK-L, FHLK, FHLK/M	228 - 235 kW		05/04→	Depth [mm]: 42; L 920 mm; Vers. produced by BEHR; W 938 mm	8MK 376 721-681 Radiator, engine cooling	510
18.310, 18.320 FAS, FALS, FHLS, FHLS/M	228 - 235 kW		05/04→	Depth [mm]: 42; L 845 mm; Vers. produced by BEHR; W 938 mm	8MK 376 728-661 Radiator, engine cooling	513
18.310, 18.320 FC, FLC, FLLC, FLLC/N, FLLW, FLLW/N	228 - 235 kW		05/04→	Depth [mm]: 52; L 938 mm; Vers. produced by BEHR; W 844 mm	8MK 376 756-011 Radiator, engine cooling	518
18.310, 18.320 FK, FK-L, FLK, FLK/M	228 - 235 kW		05/04→	Depth [mm]: 52; L 938 mm; Vers. produced by BEHR; W 919 mm	8MK 376 756-021 Radiator, engine cooling	518
18.310, 18.320 FLS, FLRS, FLLS, FLLRS	228 - 235 kW		05/04→	Ø 270 mm; 5 ports	8MV 376 757-231 Clutch, radiator fan	500
18.350, 18.360 FAC, FHLC	257 - 265 kW		05/04→	for tropical climates; Ø 245 mm; 2 ports	8MV 376 757-261 Clutch, radiator fan	500
18.350, 18.360 FAK, FAK-L, FALK, FALK-L, FHLK, FHLK/M	257 - 265 kW		05/04→	Ø 245 mm	8MV 376 757-661 Clutch, radiator fan	501
18.350, 18.360 FAS, FALS, FHLS, FHLS/M	257 - 265 kW		05/04→	Ø 754 mm; + OE 51066010275; Number of Fan Blades: 9	8MV 376 757-721 Fan Wheel, engine cooling	506
18.350, 18.360 FC, FLC, FLLC, FLLRC, FLLC/N, FLLW, FLLW/N	257 - 265 kW		05/04→	Bore Ø [mm]: 1; Depth [mm]: 128; Ø 190 mm; Number of mounting bores: 6; 2 pol; elec.	8MV 376 758-481 Clutch, radiator fan	502
18.350, 18.360 FK, FK-L, FLK, FLK/M, FLS, FLS/N, FLS/M, FLS-TS, FLLS, FLLS/N, FLLRS	257 kW		05/04→	Bore Ø [mm]: 152; Diameter 1 [mm]: 704; Diameter 2 [mm]: 127; Number of Fan Blades: 9; Number of mounting bores: 6	8MV 376 758-561 Fan Wheel, engine cooling	507
18.360 FLS, FLLS, FLRS, FLLRS	265 kW		01/06→	Bore Ø [mm]: 200; Diameter 1 [mm]: 750; Diameter 2 [mm]: 180; Number of Fan Blades: 9	8MV 376 758-571 Fan Wheel, engine cooling	508
18.390, 18.400 FAC, FHLC	287 - 294 kW		05/04→			
18.390, 18.400 FAK, FAK-L, FALK, FALK-L, FHLK, FHLK/M	287 - 294 kW		05/04→			
18.390, 18.400 FAS, FALS, FHLS, FHLS/M	287 - 294 kW		05/04→			
18.390, 18.400 FC, FLC, FLLC, FLLC/N, FLLW, FLLW/N	287 - 294 kW		05/04→			
18.390, 18.400 FK, FK-L, FLK, FLK/M	287 - 294 kW		05/04→			
18.390 FLS, FLS-TS, FLS/M, FLLS, FLLS/N, FLLRS, FLRS	287 kW		05/04→			
18.400 FLS, FLLS, FLRS, FLLRS	294 kW		10/05→			
18.430, 18.440 FAC, FHLC	316 - 324 kW		05/04→			
18.430, 18.440 FAK, FALK, FALK-L, FHLK, FHLK/M	316 - 324 kW		05/04→			
18.430, 18.440 FAS, FALS, FHLS, FHLS/M	316 - 324 kW		05/04→			
18.430, 18.440 FC, FLC, FLLC, FLLW, FLLW/N, FLLRC, FLLRW	316 - 324 kW		05/04→			
18.430, 18.440 FK, FK-L, FLK, FLK/M	316 - 324 kW		05/04→			
18.430 FLS, FLS/M, FLS-TS, FLLS, FLLS/N, FLLRS, FLRS	316 kW		05/04→			
18.440 FLS, FLLS, FLRS, FLLRS	324 kW		09/05→			
24.350, 24.360 FNLLC, FNLLW/N, FNLLRW	257 - 265 kW		05/04→			
24.350, 24.360 FPLS, FPLRS	257 - 265 kW		02/04→			
24.390, 24.400 FNLLC/N, FNLLW/N, FNLLRC, FNLLRW	287 - 294 kW		05/04→			
24.390, 24.400 FPLS, FPLRS	287 - 294 kW		05/04→			

Manufacturer - Model	Power	Displ.	Year of Constr.	Remark	Part Number	Page
MAN - TGA						04/00→
24.430, 24.440 FNLLC/N, FNLR, FNLLW	316 - 324 kW		05/04→	Depth [mm]: 42; L 920 mm; Vers. produced by BEHR; W 938 mm	8MK 376 721-681 Radiator, engine cooling	510
24.430, 24.440 FPLS, FPLRS	316 - 324 kW		05/04→	Depth [mm]: 42; L 845 mm; Vers. produced by BEHR; W 938 mm	8MK 376 728-661 Radiator, engine cooling	513
26.310, 26.320 FDC, FDR, FDC/M, FDR/M, FDL, FNHLC, FVHLC	228 - 235 kW		05/04→		Depth [mm]: 52; L 938 mm; Vers. produced by BEHR; W 844 mm	8MK 376 756-011 Radiator, engine cooling
26.310, 26.320 FDH, FDHC, FDHC/M	228 - 235 kW		06/05→	Depth [mm]: 52; L 938 mm; Vers. produced by BEHR; W 919 mm	8MK 376 756-021 Radiator, engine cooling	518
26.310, 26.320 FDHK	228 - 235 kW		06/05→	Ø 270 mm; 5 ports	8MV 376 757-231 Clutch, radiator fan	500
26.310, 26.320 FDHS, FDHS/M	228 - 235 kW		06/05→		for tropical climates; Ø 245 mm; 2 ports	8MV 376 757-261 Clutch, radiator fan
26.310, 26.320 FDH-TM	228 - 235 kW		06/05→	Ø 245 mm	8MV 376 757-661 Clutch, radiator fan	501
26.310, 26.320 FDK, FDLK	228 - 235 kW		05/04→		Ø 754 mm; + OE 51066010275; Number of Fan Blades: 9	8MV 376 757-721 Fan Wheel, engine cooling
26.310, 26.320 FDS, FDS/M, FDL, FDR, FDRS/M, FNHLS, FDLRS	228 - 235 kW		05/04→	Bore Ø [mm]: 1; Depth [mm]: 128; Ø 190 mm; Number of mounting bores: 6; 2 pol; elec.	8MV 376 758-481 Clutch, radiator fan	502
26.310, 26.320 FD-TM	228 - 235 kW		06/05→	Bore Ø [mm]: 152; Diameter 1 [mm]: 704; Diameter 2 [mm]: 127; Number of Fan Blades: 9; Number of mounting bores: 6	8MV 376 758-561 Fan Wheel, engine cooling	507
26.310, 26.320 FNLC, FNLLC, FNLR, FNLLW	228 - 235 kW		05/04→		Bore Ø [mm]: 200; Diameter 1 [mm]: 750; Diameter 2 [mm]: 180; Number of Fan Blades: 9	8MV 376 758-571 Fan Wheel, engine cooling
26.310, 26.320 FNLS, FNLLS, FNLR, FNLLRS	228 - 235 kW		05/04→			
26.310, 26.320 FVHL-KO	228 - 235 kW		06/05→			
26.310, 26.320 FVLC	228 - 235 kW		02/04→			
26.310, 26.320 FVL-KO	228 - 235 kW		02/04→			
26.350, 26.360 FDC, FDR, FDC/M, FDR/M, FDL, FNHLC	257 - 265 kW		05/04→			
26.350, 26.360 FDHK, FDHLK	257 - 265 kW		05/04→			
26.350, 26.360 FDHS, FDHS/M, FDHLS	257 - 265 kW		05/04→			
26.350, 26.360 FDH-TM	257 - 265 kW		05/04→			
26.350, 26.360 FDK, FDLK, FDRK	257 - 265 kW		05/04→			
26.350, 26.360 FDS, FDS/M, FDL, FDR, FNHLS, FPHLS	257 - 265 kW		05/04→			
26.350, 26.360 FD-TM	257 - 265 kW		02/04→			
26.350, 26.360 FNLC, FNLLC, FNLLW, FNLR, FNLLR	257 - 265 kW		05/04→			
26.350, 26.360 FNLS, FNLLS, FNLR, FNLLRS, FPLS, FPLRS	257 - 265 kW		05/04→			
26.350, 26.360 FVHL-KO	257 - 265 kW		06/05→			
26.350, 26.360 FVL-KO	257 - 265 kW		01/04→			
26.350 FDHC, FDHC/M	257 kW		04/05→			
26.350 FDL, FDLRS, FDLRS/M, FDLRS-WW	257 kW		05/04→			
26.350 FVHLC	257 kW		06/05→			
26.350 FVHLS	257 kW		07/05→			
26.350 FVLC	257 kW		01/04→			
26.350 FVLS, FVLR	257 kW		07/05→			
26.360 FDHC, FDHLC	265 kW		05/04→			
26.360 FDL, FDLRS, FDLRS-WW, FNHLS	265 kW		05/04→			
26.360 FVHLC	265 kW		04/06→			
26.360 FVHLS	265 kW		04/06→			
26.360 FVLC	265 kW		04/06→			
26.360 FVLS, FVLR	265 kW		04/06→			
26.390, 26.400 FDC, FDR, FDLR, FDR/M, FDL, FNHLC, FVHLC	287 - 294 kW		05/04→			
26.390, 26.400 FDHC, FDHC/M, FDHLC	287 - 294 kW		06/05→			
26.390, 26.400 FDHK, FDHLK	287 - 294 kW		06/05→			
26.390, 26.400 FDHS, FDHS/M, FDHLS	287 - 294 kW		06/05→			
26.390, 26.400 FDK, FDLK	287 - 294 kW		05/04→			
26.390, 26.400 FDS, FDS/M, FDL, FDLRS, FNHLS, FPHLS, FVHLS	287 - 294 kW		05/04→			
26.390, 26.400 FD-TM	287 - 294 kW		05/04→			
26.390, 26.400 FNLC, FNLLC, FNLLW, FNLR, FNLLR	287 - 294 kW		05/04→			
26.390, 26.400 FNLS, FNLLS, FNLR, FNLLRS, FPLS, FPLRS	287 - 294 kW		05/04→			
26.390, 26.400 FVHL-KO	287 - 294 kW		06/05→			
26.390, 26.400 FVL-KO	287 - 294 kW		02/04→			
26.390 FDH-TM	287 kW		06/05→			
26.390 FVLC	287 kW		02/04→			
26.390 FVLS, FVLR	287 kW		07/05→			
26.400 FDH-TM	294 kW		04/06→			
26.400 FVLC	294 kW		04/06→			
26.400 FVLS, FVLR	294 kW		04/06→			

Manufacturer - Model	Power	Displ.	Year of Constr.	Remark	Part Number	Page
MAN - TGA						04/00→
26.430, 26.440, FNLC, FNLLC, FNLLW, FNLR, FNLLRC, FVLC	316 - 324 kW		05/04→	Depth [mm]: 42; L 920 mm; Vers. produced by BEHR; W 938 mm	8MK 376 721-681 Radiator, engine cooling	510
26.430, 26.440, FNLS, FNLLS, FNLR, FNLLRS, FPLS, FPLRS	316 - 324 kW		05/04→	Depth [mm]: 42; L 845 mm; Vers. produced by BEHR; W 938 mm	8MK 376 728-661 Radiator, engine cooling	513
26.430, 26.440 FDC, FDRC, FDLC, FDLRC, FDC/M, FNHLC, FVHLC	316 - 324 kW		05/04→	Depth [mm]: 52; L 938 mm; Vers. produced by BEHR; W 844 mm	8MK 376 756-011 Radiator, engine cooling	518
26.430, 26.440 FDHC, FDHC/M, FDHLC	316 - 324 kW		06/05→	Depth [mm]: 52; L 938 mm; Vers. produced by BEHR; W 919 mm	8MK 376 756-021 Radiator, engine cooling	518
26.430, 26.440 FDHK, FDHLK	316 - 324 kW		06/05→	∅ 270 mm; 5 ports	8MV 376 757-231 Clutch, radiator fan	500
26.430, 26.440 FDHS, FDHS/M, FDHLS	316 - 324 kW		06/05→	for tropical climates; ∅ 245 mm; 2 ports	8MV 376 757-261 Clutch, radiator fan	500
26.430, 26.440 FDH-TM	316 - 324 kW		06/05→	∅ 245 mm	8MV 376 757-661 Clutch, radiator fan	501
26.430, 26.440 FDK, FDLK	316 - 324 kW		05/04→	∅ 754 mm; + OE 51066010275; Number of Fan Blades: 9	8MV 376 757-721 Fan Wheel, engine cooling	506
26.430, 26.440 FDS, FDLS, FDRS, FDLRS, FNHLS, FPHLS, FVHLS	316 - 324 kW		02/04→	Bore ∅ [mm]: 1; Depth [mm]: 128; ∅ 190 mm; Number of mounting bores: 6; 2 pol; elec.	8MV 376 758-481 Clutch, radiator fan	502
26.430, 26.440 FD-TM	316 - 324 kW		05/04→	Bore ∅ [mm]: 152; Diameter 1 [mm]: 704; Diameter 2 [mm]: 127; Number of Fan Blades: 9; Number of mounting bores: 6	8MV 376 758-561 Fan Wheel, engine cooling	507
26.430, 26.440 FVLH-KO	316 - 324 kW		06/05→	Bore ∅ [mm]: 200; Diameter 1 [mm]: 750; Diameter 2 [mm]: 180; Number of Fan Blades: 9	8MV 376 758-571 Fan Wheel, engine cooling	508
26.430 FDL, FDL/M, FDLRS-WW	316 kW		12/00→			
26.430 FVLS, FVLR	316 kW		07/05→			
26.440 FVL-KO	324 kW		09/05→			
26.440 FVLS, FVLR	324 kW		09/05→			
28.310, 28.320 FNLC, FNLLC, FNLL-LE, FNLLR-LE	228 - 235 kW		07/06→			
28.310, 28.320 FNLC, FNLLC, FNLLRC, FNLLR-LE	228 - 235 kW		07/06→			
28.310 FNLS, FNLR	228 kW		06/04→			
28.320 FNLC, FNLLC, FNLR	235 kW		06/04→			
28.320 FNLS, FNLR	235 kW		06/04→			
28.350, 28.360 FNLC, FNLLC, FNLL-LE	257 - 265 kW		07/06→			
28.350, 28.360 FNLC, FNLLC, FNLR, FNLL-LE	257 - 265 kW		06/04→			
28.350 FNLS, FNLR-WW	257 kW		02/04→			
28.360 FNLS, FNLR-WW	265 kW		04/06→			
28.390, 28.400 FNLC, FNLLC, FNLR-WW	287 - 294 kW		06/04→			
28.390 FNLS, FNLR	287 kW		05/04→			
28.400 FANLK	294 kW		07/06→			
28.400 FNLS, FNLR	294 kW		04/06→			
28.430, 28.440 FNLC, FNLLC, FNLR-WW	316 - 324 kW		06/04→			
28.430 FNLS, FNLR-WW	316 kW		05/04→			
28.440 FNLS, FNLR-WW	324 kW		09/05→			
33.350, 33.360 FDAC, FDHC, FDHC/M	257 - 265 kW		06/05→			
33.350, 33.360 FDK, FDHK	257 - 265 kW		06/05→			
33.350, 33.360 FDAS, FDHS, FDHS/M	257 - 265 kW		06/05→			
33.350, 33.360 FDC, FDC/M, FDLC, FDRC	257 - 265 kW		05/04→			
33.350, 33.360 FDK, FDLK, FDRK	257 - 265 kW		05/04→			
33.350, 33.360 FDS, FDLS, FDS/M, FDRS	257 - 265 kW		05/04→			
33.390, 33.400 FDAC, FDHC, FDHC/M	287 - 295 kW		06/05→			
33.390, 33.400 FDK, FDHK	287 - 295 kW		06/05→			
33.390, 33.400 FDAS, FDHS, FDHS/M	287 - 295 kW		06/05→			
33.390, 33.400 FDC, FDLC, FDRC, FDC/M	287 - 294 kW		05/04→			
33.390, 33.400 FDK, FDLK, FDRK	287 - 294 kW		05/04→			
33.390, 33.400 FDS, FDLS, FDLRS, FDRS, FDS/M	287 - 294 kW		05/04→			
33.430, 33.440 FDAC, FDALC, FDHC, FDHC/M	316 - 324 kW		06/05→			
33.430, 33.440 FDK, FDLK, FDHK	316 - 324 kW		06/05→			
33.430, 33.440 FDAS, FDALS, FDHS	316 - 324 kW		06/05→			
33.430, 33.440 FDC, FDLC, FDRC, FDLRC, FDC/M	316 - 324 kW		05/04→			
33.430, 33.440 FDK, FDLK, FDRK	316 - 324 kW		05/04→			
33.430, 33.440 FDS, FDLS, FDRS, FDLRS, FDS/M	316 - 324 kW		05/04→			

Manufacturer - Model	Power	Displ.	Year of Constr.	Remark	Part Number	Page
MAN - TGA						04/00→
35.390 FDNLC	287 kW		07/06→	Depth [mm]: 42; L 920 mm; Vers. produced by BEHR; W 938 mm	8MK 376 721-681 Radiator, engine cooling	510
35.400 FDNLC	294 kW		07/06→			
35.430 FDNLC	316 kW		07/06→	Depth [mm]: 42; L 845 mm; Vers. produced by BEHR; W 938 mm	8MK 376 728-661 Radiator, engine cooling	513
35.440 FDNLC	324 kW		07/06→			
39.390 FVNLC	287 kW		07/06→	Depth [mm]: 52; L 938 mm; Vers. produced by BEHR; W 844 mm	8MK 376 756-011 Radiator, engine cooling	518
39.400 FVNLC	294 kW		07/06→			
39.430 FVNLC	316 kW		07/06→	Depth [mm]: 52; L 938 mm; Vers. produced by BEHR; W 919 mm	8MK 376 756-021 Radiator, engine cooling	518
39.440 FVNLC	324 kW		07/06→			
				Ø 270 mm; 5 ports	8MV 376 757-231 Clutch, radiator fan	500
				for tropical climates; Ø 245 mm; 2 ports	8MV 376 757-261 Clutch, radiator fan	500
				Ø 245 mm	8MV 376 757-661 Clutch, radiator fan	501
				Ø 754 mm; + OE 51066010275; Number of Fan Blades: 9	8MV 376 757-721 Fan Wheel, engine cooling	506
				Bore Ø [mm]: 1; Depth [mm]: 128; Ø 190 mm; Number of mounting bores: 6; 2 pol; elec.	8MV 376 758-481 Clutch, radiator fan	502
				Bore Ø [mm]: 152; Diameter 1 [mm]: 704; Diameter 2 [mm]: 127; Number of Fan Blades: 9; Number of mounting bores: 6	8MV 376 758-561 Fan Wheel, engine cooling	507
				Bore Ø [mm]: 200; Diameter 1 [mm]: 750; Diameter 2 [mm]: 180; Number of Fan Blades: 9	8MV 376 758-571 Fan Wheel, engine cooling	508
18.310, 18320 FC, FLC, FRC, FLLC, FLLC/N, FLLW, FLLRC, FLLRW	228 - 235 kW		04/00→	Depth [mm]: 42; L 920 mm; Vers. produced by BEHR; W 938 mm	8MK 376 721-681 Radiator, engine cooling	510
18.310, 18320 FK, FLK, FK-L, FLRK	228 - 235 kW		12/00→	Depth [mm]: 42; L 845 mm; Vers. produced by BEHR; W 938 mm	8MK 376 728-661 Radiator, engine cooling	513
18.310 FAC, FARC	228 kW		09/02→	Ø 245 mm; 2 ports	8MV 376 757-251 Clutch, radiator fan	500
18.310 FAK, FAK-L, FALK	228 kW		09/02→			
18.310 FAS, FARS	228 kW		09/02→	Bore Ø [mm]: 152; Depth [mm]: 128; Ø 190 mm; Number of mounting bores: 6; 2 pol; elec.	8MV 376 758-491 Clutch, radiator fan	503
18.310 FLS, FLLS, FLLS/N, FLS-TS, FLRS, FLLRS	228 kW		04/00→			
18.360 FAC, FARC	265 kW		09/02→	Bore Ø [mm]: 200; Depth [mm]: 138; Ø 236 mm; Number of mounting bores: 6; 2 pol; elec.	8MV 376 758-511 Clutch, radiator fan	503
18.360 FAK, FALK, FAK-L, FALK-L	265 kW		09/02→			
18.360 FAS, FALS, FARS	265 kW		09/02→	Bore Ø [mm]: 152; Diameter 1 [mm]: 704; Diameter 2 [mm]: 127; Number of Fan Blades: 9; Number of mounting bores: 6	8MV 376 758-561 Fan Wheel, engine cooling	507
18.360 FC, FLC, FRC, FLLC, FLLC/N, FLLW, FLLRW	265 kW		04/00→	Bore Ø [mm]: 200; Diameter 1 [mm]: 750; Diameter 2 [mm]: 180; Number of Fan Blades: 9	8MV 376 758-571 Fan Wheel, engine cooling	508
18.360 FK, FLK, FK-L, FLRK	265 kW		12/00→			
18.360 FLS, FLLS, FLLS/N, FLS-TS, FLRS, FLLRS	265 kW		04/00→			
24.360 FNLLC/N, FNLLW, FNLLRW, FNLLRC	265 kW		09/01→			
26.310 FDAC, FDARC	228 kW		02/02→			
26.310 FDAK	228 kW		02/02→			
26.310 FDAS, FDARS	228 kW		02/02→			
26.310 FDC, FDLC, FDRC, FDLC/M, FDLRC	228 kW		01/01→			
26.310 FDK, FDLK, FDRK	228 kW		09/02→			
26.310 FDS, FDLS, FDLS/M, FDLRS	228 kW		01/01→			
26.310 FD-TM, FDR-TM	228 kW		10/00→			
26.310 FNLC, FNLLC, FVLC, FNLLW, FNLRRC, FNLLRW	228 kW		09/00→			
26.310 FPLS, FVLS, FNLS, FNLLS, FPLRS, FNLRCS, FVLRCS	228 kW		12/00→			
26.310 FVLC	228 kW		09/03→			
26.310 FVL-KO	228 kW		12/00→			
26.360 FDAC, FDARC	265 kW		02/02→			
26.360 FDAK, FDALK	265 kW		02/02→			
26.360 FDAS, FDARS	265 kW		02/02→			
26.360 FDC, FDLC, FDLC/M, FDRC, FDLRC-WW	265 kW		01/01→			
26.360 FDK, FDLK, FDRK, FDLRK	265 kW		09/02→			
26.360 FDLS, FDLS/M, FDLRS, FDLRS/M, FDLRS-WW, FDRS	265 kW		09/03→			
26.360 FDS, FDLS, FNLS, FNLLS, FPLS, FPLRS, FVLS, FVLRCS	265 kW		12/00→			
26.360 FD-TM, FDR-TM	265 kW		01/01→			
26.360 FNLC, FNLLC, FNLLW, FNLLRC, FNLLRW, FVLC	265 kW		09/00→			
26.360 FVL-KO	265 kW		12/00→			
28.310 FNLC, FNLLC	228 kW		09/02→			
28.310 FNLS, FNLRCS	228 kW		09/02→			
28.360 FNLC, FNLLC	265 kW		09/02→			
28.360 FNLS, FNLRCS	265 kW		09/02→			

Manufacturer - Model	Power	Displ.	Year of Constr.	Remark	Part Number	Page
MAN - TGA						04/00→
32.310 FFDC, FFDLC, FFDLRC	228 kW		01/02→	Depth [mm]: 42; L 920 mm; Vers. produced by BEHR; W 938 mm	8MK 376 721-681	510
32.310 FFDK, FFDLK	228 kW		01/02→		Radiator, engine cooling	
32.310 FFD-TM	228 kW		01/02→	Depth [mm]: 42; L 845 mm; Vers. produced by BEHR; W 938 mm	8MK 376 728-661	513
32.360 FFDC, FFDLC, FFDLRC	265 kW		01/02→		Radiator, engine cooling	
32.360 FFDK, FFDLK	265 kW		01/02→	Ø 245 mm; 2 ports	8MV 376 757-251	500
32.360 FFD-TM	265 kW		01/02→		Clutch, radiator fan	
33.360 FDAC, FDARC, FDAC-WW	265 kW		09/02→	Bore Ø [mm]: 152; Depth [mm]: 128; Ø 190 mm; Number of mounting bores: 6; 2 pol; elec.	8MV 376 758-491	503
33.360 FDAK, FDAK-WW	265 kW		09/02→		Clutch, radiator fan	
33.360 FDAS, FDAS-WW	265 kW		09/02→	Bore Ø [mm]: 200; Depth [mm]: 138; Ø 236 mm; Number of mounting bores: 6; 2 pol; elec.	8MV 376 758-511	503
33.360 FDC, FDC-WW, FDLC/M, FDRC-WW, FDLRC	265 kW		10/00→		Clutch, radiator fan	
33.360 FDK, FDK-WW, FDLK, FDRK-WW	265 kW		01/01→	Bore Ø [mm]: 152; Diameter 1 [mm]: 704; Diameter 2 [mm]: 127; Number of Fan Blades: 9; Number of mounting bores: 6	8MV 376 758-561 Fan	507
33.360 FDS, FDS-WW, FDLs, FDLRS, FDRS-WW	265 kW		10/00→		Wheel, engine cooling	
33.360 FD-TM, FDR-TM	265 kW		01/01→	Bore Ø [mm]: 200; Diameter 1 [mm]: 750; Diameter 2 [mm]: 180; Number of Fan Blades: 9	8MV 376 758-571 Fan	508
35.310 FFDC, FFDLC	228 kW		06/03→		Wheel, engine cooling	
35.310 FFDK, FFDLK	228 kW		06/03→			
35.310 FFD-TM	228 kW		11/03→			
35.360 FFDC, FFDLC	265 kW		10/03→			
35.360 FFDK, FFDLK	265 kW		10/03→			
35.360 FFD-TM	265 kW		11/03→			
37.310 FFDC	228 kW		12/04→			
37.310 FFDK	228 kW		12/04→			
37.310 FFD-TM	228 kW		12/04→			
37.360 FFDC	265 kW		12/04→			
37.360 FFDK	265 kW		12/04→			
37.360 FFD-TM	265 kW		12/04→			
41.360 FFDC, FFDC/M, FFDC/M-WW, FFDC	265 kW		01/03→			
41.360 FFDK-WW	265 kW		09/03→			
41.360 FFD-TM	265 kW		12/04→			
18.410, 18420 FAK, FAK-L, FALK	301 - 309 kW		09/02→	Depth [mm]: 42; L 920 mm; Vers. produced by BEHR; W 938 mm	8MK 376 721-681	510
18.410, 18420 FC, FRC, FLC, FLRC, FLLC, FLLC/N, FLLW, FLLRC	301 - 309 kW		04/00→		Radiator, engine cooling	
18.410, 18420 FK, FK-L, FLK, FLRK	301 - 309 kW		12/00→	Depth [mm]: 42; L 845 mm; Vers. produced by BEHR; W 938 mm	8MK 376 728-661	513
18.410 FAC, FARC	301 kW		09/02→		Radiator, engine cooling	
18.410 FAS, FALS, FARS	301 kW		09/02→	Ø 245 mm; 2 ports	8MV 376 757-251	500
18.410 FLS, FLLS, FLLS/N, FLS-TS, FLRS, FLLRS	301 kW		04/00→		Clutch, radiator fan	
24.410 FNLLC/N, FNLLW, FNLLRW	301 kW		09/01→	Bore Ø [mm]: 152; Depth [mm]: 128; Ø 190 mm; Number of mounting bores: 6; 2 pol; elec.	8MV 376 758-491	503
26.410 FDAC, FDARC	301 kW		02/02→		Clutch, radiator fan	
26.410 FDAK, FDALK	301 kW		02/02→	Bore Ø [mm]: 152; Diameter 1 [mm]: 704; Diameter 2 [mm]: 127; Number of Fan Blades: 9; Number of mounting bores: 6	8MV 376 758-561 Fan	507
26.410 FDAS, FDALS, FDARS	301 kW		02/02→		Wheel, engine cooling	
26.410 FDC, FDLC, FDLC/M, FDLC-WW; FDRC-WW, FDLRC-WW	301 kW		01/01→	Bore Ø [mm]: 200; Diameter 1 [mm]: 750; Diameter 2 [mm]: 180; Number of Fan Blades: 9	8MV 376 758-571 Fan	508
26.410 FDK, FDRK, FDLK, FDLRK	301 kW		09/01→		Wheel, engine cooling	
26.410 FDS, FDLs, FDLs/M, FDLs-WW, FDRS-WW, FDLRS-WW	301 kW		06/01→			
26.410 FD-TM, FDR-TM	301 kW		01/01→			
26.410 FNLC, FNLLC, FNLLW, FNLRK, FNLLRC, FVLC	301 kW		04/00→			
26.410 FPLS, FPLRS, FVLS, FNLS, FNLLS	301 kW		12/00→			
26.410 FVLC	301 kW		09/03→			
26.410 FVL-KO	301 kW		12/00→			
26.410 FVLS, FVLRs	301 kW		07/05→			
28.410 FANLC	301 kW		07/06→			
28.410 FANLK	301 kW		07/06→			
28.410 FNLC, FNLLC	301 kW		09/02→			
28.410 FNLC, FNLLC, FNLRK	301 kW		09/02→			
28.410 FNLS, FNLRs	301 kW		09/02→			
32.410 FFDC, FFDLC, FFDC, FFDLRC	301 kW		01/02→			
32.410 FFDK, FFDLK	301 kW		01/02→			
32.410 FFD-TM	301 kW		01/02→			
33.410 FDAC, FDAC-WW, FDALC	301 kW		09/02→			
33.410 FDAK, FDAK-WW, FDALK	301 kW		09/02→			
33.410 FDAS, FDAS-WW, FDALS	301 kW		09/02→			
33.410 FDC, FDC-WW, FDLC, FDLRC, FDRK-WW	301 kW		10/00→			

Manufacturer - Model	Power	Displ.	Year of Constr.	Remark	Part Number	Page
MAN - TGA						04/00→
33.410 FDK, FDK-WW, FDLK, FDRK-WW	301 kW		10/00→	Depth [mm]: 42; L 920 mm; Vers. produced by BEHR; W 938 mm	8MK 376 721-681 Radiator, engine cooling	510
33.410 FDS, FDS-WW, FDLS, FDLS/M, FDLRS, FDRS-WW	301 kW		10/00→	Depth [mm]: 42; L 845 mm; Vers. produced by BEHR; W 938 mm	8MK 376 728-661 Radiator, engine cooling	513
33.410 FD-TM, FDR-TM	301 kW		10/00→	Ø 245 mm; 2 ports	8MV 376 757-251 Clutch, radiator fan	500
35.410 FDNLC	301 kW		07/06→			
35.410 FFDAK	301 kW		07/06→			
35.410 FFDC, FFDLC	301 kW		10/03→	Bore Ø [mm]: 152; Depth [mm]: 128; Ø 190 mm; Number of mounting bores: 6; 2 pol; elec.	8MV 376 758-491 Clutch, radiator fan	503
35.410 FFDK, FFDLK	301 kW		10/03→			
35.410 FFD-TM	301 kW		11/03→	Bore Ø [mm]: 152; Diameter 1 [mm]: 704; Diameter 2 [mm]: 127; Number of Fan Blades: 9; Number of mounting bores: 6	8MV 376 758-561 Fan Wheel, engine cooling	507
35.410 FFNLC	301 kW		07/06→			
37.410 FFDC	301 kW		12/04→			
37.410 FFDK	301 kW		12/04→	Bore Ø [mm]: 200; Diameter 1 [mm]: 750; Diameter 2 [mm]: 180; Number of Fan Blades: 9	8MV 376 758-571 Fan Wheel, engine cooling	508
37.410 FFD-TM	301 kW		12/04→			
40.410 FDAK-WW	301 kW		04/04→			
40.410 FDAS-WW	301 kW		04/04→			
41.410 FFDAK	301 kW		07/06→			
41.410 FFDC-WW, FDRC	301 kW		09/03→			
41.410 FFDK-WW	301 kW		09/03→			
41.410 FFD-TM	301 kW		12/04→			
18.460 FAK	338 kW		12/00→	Ø 245 mm; 2 ports	8MV 376 757-251 Clutch, radiator fan	500
18.460 FC, FLC, FRC, FLLC, FLLC/N, FLLW, FLLRC, FLLRW	338 kW		04/00→	Depth [mm]: 42; L 920 mm; Vers. produced by BEHR; W 938 mm	8MK 376 721-681 Radiator, engine cooling	510
18.460 FK, FK-L, FLK, FLRK	338 kW		12/00→	Depth [mm]: 42; L 845 mm; Vers. produced by BEHR; W 938 mm	8MK 376 728-661 Radiator, engine cooling	513
18.460 FLS, FLLS, FLLS/N, FLS-TS, FLRS, FLLRS	338 kW		04/00→	Ø 245 mm; 2 ports	8MV 376 757-251 Clutch, radiator fan	500
24.460 FNLLC/N, FNLLW, FNLLRC, FNLLRW	338 kW		09/01→			
26.460 FDC, FDLC, FDLC/M, FDLC-WW, FDRC, FDLRC-WW	338 kW		01/01→	Bore Ø [mm]: 152; Depth [mm]: 128; Ø 190 mm; Number of mounting bores: 6; 2 pol; elec.	8MV 376 758-491 Clutch, radiator fan	503
26.460 FDK, FDLK, FDLRK	338 kW		01/01→	Bore Ø [mm]: 200; Depth [mm]: 138; Ø 236 mm; Number of mounting bores: 6; 2 pol; elec.	8MV 376 758-511 Clutch, radiator fan	503
26.460 FDS, FDLS, FDLS/M, FDLS-WW, FDRS-WW, FDLRS-WW	338 kW		06/01→	Bore Ø [mm]: 200; Depth [mm]: 105; Ø 236 mm; Number of mounting bores: 6; 2 pol; elec.	8MV 376 758-531 Clutch, radiator fan	504
26.460 FD-TM, FDR-TM	338 kW		01/01→	Bore Ø [mm]: 152; Diameter 1 [mm]: 704; Diameter 2 [mm]: 127; Number of Fan Blades: 9; Number of mounting bores: 6	8MV 376 758-561 Fan Wheel, engine cooling	507
26.460 FNLC, FNLR, FNLLC, FNLLRW, FNLLRC	338 kW		04/00→			
26.460 FPLS, FPLRS, FVLS, FVLRS, FNLS, FNLLS, FNLR	338 kW		12/00→	Bore Ø [mm]: 200; Diameter 1 [mm]: 750; Diameter 2 [mm]: 180; Number of Fan Blades: 9	8MV 376 758-571 Fan Wheel, engine cooling	508
26.460 FVLC	338 kW		02/01→			
26.460 FVL-KO	338 kW		12/00→			
28.460 FNLC, FNLLC, FNLR	338 kW		09/02→			
28.460 FNLS, FNLR	338 kW		09/02→			
32.460 FFDC, FFDLC, FFDLRC	338 kW		01/02→			
32.460 FFDK, FFDLK	338 kW		01/02→			
32.460 FFD-TM	338 kW		01/02→			
33.460 FDAC-WW	338 kW		09/02→			
33.460 FDAK-WW	338 kW		09/02→			
33.460 FDAS-WW	338 kW		09/02→			
33.460 FDC, FDC-WW, FDLC, FDLRC, FDRC-WW	338 kW		09/02→			
33.460 FDK, FDK-WW, FDLK, FDRK-WW	338 kW		09/02→			
33.460 FDS, FDLS, FDLS/M, FDLRS, FDRS-WW	338 kW		09/02→			
33.460 FD-TM, FDR-TM	338 kW		09/02→			
35.460 FFDC, FFDLC	338 kW		10/03→			
35.460 FFDK, FFDLK	338 kW		10/03→			
35.460 FFD-TM	338 kW		11/03→			
35.460 FFNLC	338 kW		07/06→			
37.460 FFDC	338 kW		12/04→			
37.460 FFDK	338 kW		12/04→			
37.460 FFD-TM	338 kW		12/04→			
40.460 FDAK-WW	338 kW		04/04→			
40.460 FDAS-WW	338 kW		04/04→			
41.460 FFDC-WW, FFDR	338 kW		09/03→			
41.460 FFDK-WW	338 kW		09/03→			
41.460 FFD-TM	338 kW		12/04→			
18.480 FAC	353 kW		02/06→	Depth [mm]: 42; L 845 mm; Vers. produced by BEHR; W 938 mm	8MK 376 728-661 Radiator, engine cooling	513
18.480 FAK, FALK	353 kW		02/06→			
18.480 FAS, FALS	353 kW		02/06→	Depth [mm]: 52; L 938 mm; Vers. produced by BEHR; W 844 mm	8MK 376 756-011 Radiator, engine cooling	518
35.480 FFDAK, FFDHK, FFDHLK	353 kW		07/06→			
35.480 FFDH-TM	353 kW		07/06→	Ø 270 mm; 5 ports	8MV 376 757-231 Clutch, radiator fan	500
35.480 FFNHLC	353 kW		11/06→	for tropical climates; Ø 245 mm; 2 ports	8MV 376 757-261 Clutch, radiator fan	500
				Ø 245 mm	8MV 376 757-661 Clutch, radiator fan	501

Manufacturer - Model	Power	Displ.	Year of Constr.	Remark	Part Number	Page
MAN - TGA						04/00→
18.480 FAC	353 kW		02/06→	Bore Ø [mm]: 152; Diameter 1 [mm]: 704; Diameter 2 [mm]: 127; Number of Fan Blades: 9; Number of mounting bores: 6	8MV 376 758-561 Fan Wheel, engine cooling	507
18.480 FAK, FALK	353 kW		02/06→			
18.480 FAS, FALS	353 kW		02/06→			
35.480 FFDK, FFDHK, FFDHLK	353 kW		07/06→			
35.480 FFDH-TM	353 kW		07/06→			
35.480 FFNHLC	353 kW		11/06→	Bore Ø [mm]: 200; Diameter 1 [mm]: 750; Diameter 2 [mm]: 180; Number of Fan Blades: 9	8MV 376 758-571 Fan Wheel, engine cooling	508
18.480 FAC, FARC	353 kW		09/02→	Depth [mm]: 42; L 920 mm; Vers. produced by BEHR; W 938 mm	8MK 376 721-681 Radiator, engine cooling	510
				Depth [mm]: 42; L 845 mm; Vers. produced by BEHR; W 938 mm	8MK 376 728-661 Radiator, engine cooling	513
				Ø 245 mm; 2 ports	8MV 376 757-251 Clutch, radiator fan	500
				Bore Ø [mm]: 200; Depth [mm]: 105; Ø 236 mm; Number of mounting bores: 6; 2 pol; elec.	8MV 376 758-531 Clutch, radiator fan	504
18.480 FAK, FAK-L, FALK	353 kW		09/02→	Depth [mm]: 42; L 920 mm; Vers. produced by BEHR; W 938 mm	8MK 376 721-681 Radiator, engine cooling	510
18.480 FAS, FALS, FARS	353 kW		09/02→			
18.480 FC, FLC, FLLC, FLLW, FLLRW, FLLRC	353 kW		09/02→	Depth [mm]: 42; L 845 mm; Vers. produced by BEHR; W 938 mm	8MK 376 728-661 Radiator, engine cooling	513
18.480 FK, FLK, FK-L	353 kW		09/02→	Ø 245 mm; 2 ports	8MV 376 757-251 Clutch, radiator fan	500
18.480 FLS, FLLS, FLLS/N, FLS-TS, FLRS-WW	353 kW		09/02→			
18.530 FAC	390 kW		04/04→	Bore Ø [mm]: 200; Depth [mm]: 105; Ø 236 mm; Number of mounting bores: 6; 2 pol; elec.	8MV 376 758-531 Clutch, radiator fan	504
18.530 FAK, FALK	390 kW		04/04→			
18.530 FAS, FALS	390 kW		04/04→	Bore Ø [mm]: 152; Diameter 1 [mm]: 704; Diameter 2 [mm]: 127; Number of Fan Blades: 9; Number of mounting bores: 6	8MV 376 758-561 Fan Wheel, engine cooling	507
18.530 FC, FLC, FLLC, FLLC/N, FLLW, FLLRC, FLLRW	390 kW		09/02→	Bore Ø [mm]: 200; Diameter 1 [mm]: 750; Diameter 2 [mm]: 180; Number of Fan Blades: 9	8MV 376 758-571 Fan Wheel, engine cooling	508
18.530 FLS, FLLS, FLLS/N	390 kW		09/02→			
24.480 FNLLC/N, FNLLW, FNLLRC, FNLLRW	353 kW		09/02→			
24.480 FPLS, FPLRS	353 kW		07/05→			
24.530 FNLLC/N, FNLLW, FNLLRW	390 kW		09/01→			
24.530 FPLS, FPLRS	390 kW		07/05→			
26.480 FDAC, FDALC, FDARC	353 kW		09/02→			
26.480 FDK, FDLK, FDLRK	353 kW		09/02→			
26.480 FDAK, FDALK	353 kW		09/02→			
26.480 FDAS, FDALS, FDARS	353 kW		09/02→			
26.480 FDC, FDLC, FDCR, FDLC/M, FDLRC-WW	353 kW		09/02→			
26.480 FDK, FDLK, FDLRK	353 kW		09/02→			
26.480 FDS, FDLS, FDLS/M, FDLRS-WW, FDRS	353 kW		09/02→			
26.480 FD-TM	353 kW		09/02→			
26.480 FNLC, FNLLC, FVLC, FNLLRC, FVLLW	353 kW		09/02→			
26.480 FNLS, FNLLS, FNLRs, FPLS, FVLS	353 kW		09/02→			
26.480 FVL-KO	353 kW		09/02→			
26.530 FDAC, FDALC	390 kW		07/06→			
26.530 FDK, FDLK, FDLRK	390 kW		09/02→			
26.530 FDS, FDLS, FDLS/M, FDLRS	390 kW		07/06→			
26.530 FDC, FDLC, FDC/M, FDLRC	390 kW		01/01→			
26.530 FDK, FDLK, FDLRK	390 kW		09/02→			
26.530 FDS, FDLS, FDLS/M, FDLRS	390 kW		01/01→			
26.530 FNLC, FNLLC, FNLLW, FNLLRC, FVLC, FVLRc	390 kW		09/02→			
26.530 FNLS, FNLLS, FNLRs, FPLS, FVLS, FVLRs	390 kW		09/02→			
28.390 FNLLC	353 kW		07/06→			
28.480 FNLC, FNLLC, FNLRc	353 kW		09/02→			
28.480 FNLS, FNLRs	353 kW		09/02→			
28.530 FANLC	390 kW		07/06→			
28.530 FANLK	390 kW		07/06→			
28.530 FNLC, FNLLC, FNLRc	390 kW		09/02→			
28.530 FNLS, FNLRs	390 kW		09/02→			
32.480 FFDK, FFDLC, FFDLRC	353 kW		09/02→			
32.480 FFDK, FFDLK	353 kW		09/02→			
32.480 FFD-TM	353 kW		09/02→			
33.480 FDAC, FDAC-WW, FDALC, FDARC	353 kW		09/02→			
33.480 FDK, FDK-WW, FDALK	353 kW		09/02→			
33.480 FDAS, FDAS-WW, FDARS, FDALS	353 kW		09/02→			
33.480 FDC, FDC-WW, FDLc, FDLRC-WW, FDLRC	353 kW		09/02→			
33.480 FDK, FDK-WW, FDLK, FDLRC-WW	353 kW		09/02→			

Manufacturer - Model	Power	Displ.	Year of Constr.	Remark	Part Number	Page
MAN - TGA						04/00→
33.480 FDS, FDS-WW, FDLs, FDLs/M, FDRS-WW, FDLRS	353 kW		09/02→	Depth [mm]: 42; L 920 mm; Vers. produced by BEHR; W 938 mm	8MK 376 721-681 Radiator, engine cooling	510
33.480 FD-TM	353 kW		09/02→	Depth [mm]: 42; L 845 mm; Vers. produced by BEHR; W 938 mm	8MK 376 728-661 Radiator, engine cooling	513
33.530 FDAK, FDALC	390 kW		09/02→			
33.530 FDALK	390 kW		09/02→			
33.530 FDAS, FDALS	390 kW		09/02→	Ø 245 mm; 2 ports	8MV 376 757-251 Clutch, radiator fan	500
33.530 FDC, FDC/M, FDLC, FDRC, FDLRC	390 kW		09/02→	Bore Ø [mm]: 200; Depth [mm]: 105; Ø 236 mm; Number of mounting bores: 6; 2 pol; elec.	8MV 376 758-531 Clutch, radiator fan	504
33.530 FDK, FDLK	390 kW		07/03→			
33.530 FDS, FDLs, FDLs/M, FDRS, FDLRS	390 kW		07/03→	Bore Ø [mm]: 152; Diameter 1 [mm]: 704; Diameter 2 [mm]: 127; Number of Fan Blades: 9; Number of mounting bores: 6	8MV 376 758-561 Fan Wheel, engine cooling	507
35.480 FFDARS	353 kW		07/06→			
35.480 FFDLC	353 kW		10/03→			
35.480 FFDK, FFDLK	353 kW		10/03→			
35.480 FFD-TM	353 kW		11/03→			
35.530 FDNLC	390 kW		04/04→			
35.530 FDDAK	390 kW		07/06→			
35.530 FFDC, FFDLC	390 kW		04/04→			
35.530 FFDK, FFDLK	390 kW		04/04→			
35.530 FFD-TM	390 kW		04/04→			
35.530 FFNLC	390 kW		07/06→			
37.480 FFDC	353 kW		12/04→			
37.480 FFDK	353 kW		12/04→			
37.480 FFD-TM	353 kW		12/04→			
37.530 FFDC	390 kW		12/04→			
37.530 FFDK	390 kW		12/04→			
37.530 FFD-TM	390 kW		12/04→			
40.480 FDAK-WW	353 kW		04/04→			
41.480 FFDARC	353 kW		07/06→			
41.480 FFDC-WW, FFDRC	353 kW		06/05→			
41.480 FFDK-WW	353 kW		06/05→			
41.480 FFD-TM	353 kW		12/04→			
41.530 FDDAK	353 kW		07/06→			
41.530 FDDAK	390 kW		07/06→			
41.530 FFDC	390 kW		12/04→			
41.530 FFDK	390 kW		12/04→			
41.530 FFD-TM	390 kW		12/04→			
18.480 FC, FLC, FLLC, FLLRC, FLLW, FLRC	353 kW		01/06→	Depth [mm]: 42; L 920 mm; Vers. produced by BEHR; W 938 mm	8MK 376 721-681 Radiator, engine cooling	510
				Depth [mm]: 42; L 845 mm; Vers. produced by BEHR; W 938 mm	8MK 376 728-661 Radiator, engine cooling	513
				Depth [mm]: 52; L 938 mm; Vers. produced by BEHR; W 844 mm	8MK 376 756-011 Radiator, engine cooling	518
				Depth [mm]: 52; L 938 mm; Vers. produced by BEHR; W 919 mm	8MK 376 756-021 Radiator, engine cooling	518
				Ø 270 mm; 5 ports	8MV 376 757-231 Clutch, radiator fan	500
				for tropical climates; Ø 245 mm; 2 ports	8MV 376 757-261 Clutch, radiator fan	500
				Bore Ø [mm]: 200; Depth [mm]: 105; Ø 236 mm; Number of mounting bores: 6; 2 pol; elec.	8MV 376 758-531 Clutch, radiator fan	504
				Bore Ø [mm]: 152; Diameter 1 [mm]: 704; Diameter 2 [mm]: 127; Number of Fan Blades: 9; Number of mounting bores: 6	8MV 376 758-561 Fan Wheel, engine cooling	507
				Bore Ø [mm]: 200; Diameter 1 [mm]: 750; Diameter 2 [mm]: 180; Number of Fan Blades: 9	8MV 376 758-571 Fan Wheel, engine cooling	508
18.480 FHLC	353 kW		04/06→	Depth [mm]: 42; L 920 mm; Vers. produced by BEHR; W 938 mm	8MK 376 721-681 Radiator, engine cooling	510
18.480 FHLK, FHLK/M	353 kW		04/06→			
18.480 FHLS, FHLS/M	353 kW		04/06→	Depth [mm]: 42; L 845 mm; Vers. produced by BEHR; W 938 mm	8MK 376 728-661 Radiator, engine cooling	513
18.480 FK, FK-L, FLK	353 kW		01/06→			
26.480 FDC, FDC/M, FDLC, FDLRC, FDRC, FNHLC, FVHLC, FDLRC-WW	353 kW		02/06→	Depth [mm]: 52; L 938 mm; Vers. produced by BEHR; W 844 mm	8MK 376 756-011 Radiator, engine cooling	518
26.480 FDHC, FDHC/M, FDHLC	353 kW		02/06→	Depth [mm]: 52; L 938 mm; Vers. produced by BEHR; W 919 mm	8MK 376 756-021 Radiator, engine cooling	518
26.480 FDHK, FDHLK	353 kW		02/06→			
26.480 FDHS, FDHS/M, FDHLS	353 kW		02/06→	Ø 270 mm; 5 ports	8MV 376 757-231 Clutch, radiator fan	500
26.480 FDH-TM	353 kW		02/06→			
26.480 FDK, FDLK	353 kW		02/06→			
26.480 FDS, FDLs, FDLRS, FNHLS, FPHLS, FVHLS	353 kW		02/06→	for tropical climates; Ø 245 mm; 2 ports	8MV 376 757-261 Clutch, radiator fan	500
26.480 FD-TM	353 kW		02/06→	Ø 245 mm	8MV 376 757-661 Clutch, radiator fan	501
26.480 FVHL-KO	353 kW		02/06→			
33.480 FDAC, FDALC, FDHC, FDHC/M	353 kW		02/06→	Ø 754 mm; + OE 51066010275; Number of Fan Blades: 9	8MV 376 757-721 Fan Wheel, engine cooling	506
33.480 FDAK, FDALK, FDHK	353 kW		02/06→	Bore Ø [mm]: 152; Diameter 1 [mm]: 704; Diameter 2 [mm]: 127; Number of Fan Blades: 9; Number of mounting bores: 6	8MV 376 758-561 Fan Wheel, engine cooling	507
33.480 FDAS, FDALS, FDHS	353 kW		02/06→			
33.480 FDC, FDLC, FDRC, FDC/M	353 kW		01/06→	Bore Ø [mm]: 200; Diameter 1 [mm]: 750; Diameter 2 [mm]: 180; Number of Fan Blades: 9	8MV 376 758-571 Fan Wheel, engine cooling	508
33.480 FDK, FDLK, FDRK	353 kW		01/06→			

Manufacturer - Model	Power	Displ.	Year of Constr.	Remark	Part Number	Page				
MAN - TGA						04/00→				
33.480 FDS, FDRS, FDLS, FDS/M	353 kW		01/06→	Depth [mm]: 42; L 920 mm; Vers. produced by BEHR; W 938 mm	8MK 376 721-681 Radiator, engine cooling	510				
				Depth [mm]: 42; L 845 mm; Vers. produced by BEHR; W 938 mm	8MK 376 728-661 Radiator, engine cooling	513				
				Depth [mm]: 52; L 938 mm; Vers. produced by BEHR; W 844 mm	8MK 376 756-011 Radiator, engine cooling	518				
				Depth [mm]: 52; L 938 mm; Vers. produced by BEHR; W 919 mm	8MK 376 756-021 Radiator, engine cooling	518				
				Ø 270 mm; 5 ports	8MV 376 757-231 Clutch, radiator fan	500				
				for tropical climates; Ø 245 mm; 2 ports	8MV 376 757-261 Clutch, radiator fan	500				
				Ø 245 mm	8MV 376 757-661 Clutch, radiator fan	501				
				Ø 754 mm; + OE 51066010275; Number of Fan Blades: 9	8MV 376 757-721 Fan Wheel, engine cooling	506				
				Bore Ø [mm]: 152; Diameter 1 [mm]: 704; Diameter 2 [mm]: 127; Number of Fan Blades: 9; Number of mounting bores: 6	8MV 376 758-561 Fan Wheel, engine cooling	507				
Bore Ø [mm]: 200; Diameter 1 [mm]: 750; Diameter 2 [mm]: 180; Number of Fan Blades: 9	8MV 376 758-571 Fan Wheel, engine cooling	508								
18.480 FLS, FLLS, FLRS, FLLRS 18.540 FLC, FLRC, FLLC, FLLRC, FLLW 18.540 FLS, FLRS, FLLS, FLLRS 24.480 FNLLC/N, FNLLW/N 24.480 FPLS, FPLRS 24.540 FNLLC/N, FLLCW/N 26.480 FNLC, FNLCR-WW, FNLLC, FNLLRC, FNLLW, FVLC 26.480 FNLS, FNLLS, FNLRs, FPLS, FVLS, FVLRs 26.480 FVL-KO 26.540 FNLC, FNLLC, FNLLRC, FNLLW 28.480 FNLC, FNLCR-WW, FNLLC 28.480 FNLS, FNLRs-WW 28.540 FNLC, FNLLC 28.540 FNLS 39.480 FVNLC	353 kW 397 kW 397 kW 353 kW 353 kW 397 kW 353 kW 353 kW 353 kW 353 kW 353 kW 353 kW 353 kW 353 kW 353 kW		01/06→ 08/06→ 08/06→ 01/06→ 01/06→ 01/06→ 02/06→ 02/06→ 01/06→ 08/06→ 02/06→ 02/06→ 08/06→ 08/06→ 08/06→ 07/06→	Depth [mm]: 42; L 920 mm; Vers. produced by BEHR; W 938 mm	8MK 376 721-681 Radiator, engine cooling	510				
				Depth [mm]: 42; L 845 mm; Vers. produced by BEHR; W 938 mm	8MK 376 728-661 Radiator, engine cooling	513				
				Depth [mm]: 52; L 938 mm; Vers. produced by BEHR; W 844 mm	8MK 376 756-011 Radiator, engine cooling	518				
				Depth [mm]: 52; L 938 mm; Vers. produced by BEHR; W 919 mm	8MK 376 756-021 Radiator, engine cooling	518				
				Ø 270 mm; 5 ports	8MV 376 757-231 Clutch, radiator fan	500				
				for tropical climates; Ø 245 mm; 2 ports	8MV 376 757-261 Clutch, radiator fan	500				
				Ø 245 mm	8MV 376 757-661 Clutch, radiator fan	501				
				Bore Ø [mm]: 152; Diameter 1 [mm]: 704; Diameter 2 [mm]: 127; Number of Fan Blades: 9; Number of mounting bores: 6	8MV 376 758-561 Fan Wheel, engine cooling	507				
				Bore Ø [mm]: 200; Diameter 1 [mm]: 750; Diameter 2 [mm]: 180; Number of Fan Blades: 9	8MV 376 758-571 Fan Wheel, engine cooling	508				
				18.510 FC, FLC, FRC, FLLC, FLLC/N, FLLW, FLLRC, FLLRW 18.510 FLS, FLLS, FLLS/N, FLRS, FLLRS 24.510 FNLLC/N, FNLLW, FNLLRW 26.510 FDC, FDC/M, FDRC, FDLC, FDLC/M, FDLRC 26.510 FDS, FDLS, FDLS/M, FDRS, FDLRS 26.510 FNLC, FNLLC, FNLLW, FNLLRC, FVLC 26.510 FNLS, FNLLS, FNLRs, FPLS, FVLS 28.510 FNLC, FNLLC, FNLCR 28.510 FNLS, FNLRs 33.510 FDC, FDC/M, FDLC, FDRC, FDLRC 33.510 FDS, FDLS/M, FDRS, FDLRS/M	375 kW 375 kW 375 kW 375 kW 375 kW 375 kW 375 kW 375 kW 375 kW 375 kW 375 kW 375 kW		09/00→ 04/00→ 09/01→ 01/01→ 01/01→ 12/00→ 12/00→ 09/02→ 09/02→ 09/02→ 09/02→	Depth [mm]: 42; L 920 mm; Vers. produced by BEHR; W 938 mm	8MK 376 721-681 Radiator, engine cooling	510
								Depth [mm]: 42; L 845 mm; Vers. produced by BEHR; W 938 mm	8MK 376 728-661 Radiator, engine cooling	513
								Ø 245 mm; 2 ports	8MV 376 757-251 Clutch, radiator fan	500
								Bore Ø [mm]: 152; Depth [mm]: 128; Ø 190 mm; Number of mounting bores: 6; 2 pol; elec.	8MV 376 758-491 Clutch, radiator fan	503
								Bore Ø [mm]: 200; Depth [mm]: 105; Ø 236 mm; Number of mounting bores: 6; 2 pol; elec.	8MV 376 758-531 Clutch, radiator fan	504
								Bore Ø [mm]: 152; Diameter 1 [mm]: 704; Diameter 2 [mm]: 127; Number of Fan Blades: 9; Number of mounting bores: 6	8MV 376 758-561 Fan Wheel, engine cooling	507
Bore Ø [mm]: 200; Diameter 1 [mm]: 750; Diameter 2 [mm]: 180; Number of Fan Blades: 9	8MV 376 758-571 Fan Wheel, engine cooling	508								
19.350 FS, FRS, FLS, FLRS-WW 19.360 FS, FRS, FLS, FLRS-WW 19.390 FS, FRS, FLS, FLRS-WW 19.400 FS/M-WW, FRS/M-WW, FLS, FLRS 19.430 FS/M-WW, FLS, FRS, FLRS 26.350 FDLRC-WW 26.360 FDLC-WW, FDLRC 40.390, 40.400 FDK-WW, FDRK 40.390, 40.400 FDS-WW, FDRS 40.430 FDK-WW, FDRK 40.430 FDS-WW, FDRS 41.350 FFDC-TM, FFDC-TM 41.360 FFD 41.360 FFDC-TM, FDCR-TM 41.390 FFDC-TM, FDCR-TM 41.400 FFD	257 kW 265 kW 287 kW 294 kW 316 kW 257 kW 265 kW 287 - 294 kW 287 - 294 kW 316 kW 316 kW 257 kW 265 kW 265 kW 287 kW 294 kW		05/04→ 05/04→ 05/04→ 05/04→ 05/04→ 05/04→ 06/05→ 06/05→ 06/05→ 06/05→ 09/07→ 12/08→ 09/07→ 09/07→ 12/08→					Depth [mm]: 42; L 845 mm; Vers. produced by BEHR; W 938 mm	8MK 376 728-661 Radiator, engine cooling	513
								Ø 270 mm; 5 ports	8MV 376 757-231 Clutch, radiator fan	500
								for tropical climates; Ø 245 mm; 2 ports	8MV 376 757-261 Clutch, radiator fan	500
								Ø 245 mm	8MV 376 757-661 Clutch, radiator fan	501
								Ø 754 mm; + OE 51066010275; Number of Fan Blades: 9	8MV 376 757-721 Fan Wheel, engine cooling	506
				Bore Ø [mm]: 1; Depth [mm]: 128; Ø 190 mm; Number of mounting bores: 6; 2 pol; elec.	8MV 376 758-481 Clutch, radiator fan	502				
				Bore Ø [mm]: 152; Diameter 1 [mm]: 704; Diameter 2 [mm]: 127; Number of Fan Blades: 9; Number of mounting bores: 6	8MV 376 758-561 Fan Wheel, engine cooling	507				
				Bore Ø [mm]: 200; Diameter 1 [mm]: 750; Diameter 2 [mm]: 180; Number of Fan Blades: 9	8MV 376 758-571 Fan Wheel, engine cooling	508				

Manufacturer - Model	Power	Displ.	Year of Constr.	Remark	Part Number	Page
MAN - TGA						04/00→
41.400 FFDC-TM, FDRC-TM	294 kW		09/07→	Depth [mm]: 42; L 845 mm; Vers. produced by BEHR; W 938 mm Ø 270 mm; 5 ports for tropical climates; Ø 245 mm; 2 ports Ø 245 mm Ø 754 mm; + OE 51066010275; Number of Fan Blades: 9 Bore Ø [mm]: 1; Depth [mm]: 128; Ø 190 mm; Number of mounting bores: 6; 2 pol; elec. Bore Ø [mm]: 152; Diameter 1 [mm]: 704; Diameter 2 [mm]: 127; Number of Fan Blades: 9; Number of mounting bores: 6 Bore Ø [mm]: 200; Diameter 1 [mm]: 750; Diameter 2 [mm]: 180; Number of Fan Blades: 9	8MK 376 728-661	513
41.430 FFDC-TM, FFDC	316 kW		09/07→		Radiator, engine cooling	
					8MV 376 757-231	500
					Clutch, radiator fan	
					8MV 376 757-261	500
					Clutch, radiator fan	
					8MV 376 757-661	501
					Clutch, radiator fan	
				8MV 376 757-721 Fan	506	
				Wheel, engine cooling		
				8MV 376 758-481	502	
				Clutch, radiator fan		
				8MV 376 758-561 Fan	507	
				Wheel, engine cooling		
				8MV 376 758-571 Fan	508	
				Wheel, engine cooling		
19.360 FS/M-WW, FRS/M-WW	265 kW		05/04→	Depth [mm]: 42; L 845 mm; Vers. produced by BEHR; W 938 mm Ø 245 mm; 2 ports Bore Ø [mm]: 152; Depth [mm]: 128; Ø 190 mm; Number of mounting bores: 6; 2 pol; elec. Bore Ø [mm]: 200; Depth [mm]: 138; Ø 236 mm; Number of mounting bores: 6; 2 pol; elec. Bore Ø [mm]: 152; Diameter 1 [mm]: 704; Diameter 2 [mm]: 127; Number of Fan Blades: 9; Number of mounting bores: 6 Bore Ø [mm]: 200; Diameter 1 [mm]: 750; Diameter 2 [mm]: 180; Number of Fan Blades: 9	8MK 376 728-661	513
					Radiator, engine cooling	
					8MV 376 757-251	500
					Clutch, radiator fan	
					8MV 376 758-491	503
					Clutch, radiator fan	
				8MV 376 758-511	503	
				Clutch, radiator fan		
				8MV 376 758-561 Fan	507	
				Wheel, engine cooling		
				8MV 376 758-571 Fan	508	
				Wheel, engine cooling		
19.410 FS/M-WW, FRS/M-WW	301 kW		05/04→	Depth [mm]: 42; L 845 mm; Vers. produced by BEHR; W 938 mm Ø 245 mm; 2 ports Bore Ø [mm]: 152; Depth [mm]: 128; Ø 190 mm; Number of mounting bores: 6; 2 pol; elec. Bore Ø [mm]: 152; Diameter 1 [mm]: 704; Diameter 2 [mm]: 127; Number of Fan Blades: 9; Number of mounting bores: 6 Bore Ø [mm]: 200; Diameter 1 [mm]: 750; Diameter 2 [mm]: 180; Number of Fan Blades: 9	8MK 376 728-661	513
40.410 FDK-WW	301 kW		04/04→		Radiator, engine cooling	
40.410 FDS-WW	301 kW		04/04→		8MV 376 757-251	500
					Clutch, radiator fan	
					8MV 376 758-491	503
				Clutch, radiator fan		
				8MV 376 758-561 Fan	507	
				Wheel, engine cooling		
				8MV 376 758-571 Fan	508	
				Wheel, engine cooling		
19.440 FRS, FS/M-WW, FLS, FLRS	324 kW		02/06→	Depth [mm]: 42; L 845 mm; Vers. produced by BEHR; W 938 mm Ø 270 mm; 5 ports for tropical climates; Ø 245 mm; 2 ports Ø 245 mm Ø 754 mm; + OE 51066010275; Number of Fan Blades: 9 Bore Ø [mm]: 152; Diameter 1 [mm]: 704; Diameter 2 [mm]: 127; Number of Fan Blades: 9; Number of mounting bores: 6 Bore Ø [mm]: 200; Diameter 1 [mm]: 750; Diameter 2 [mm]: 180; Number of Fan Blades: 9	8MK 376 728-661	513
19.480 FLS, FRS, FLRS-WW	353 kW		02/06→		Radiator, engine cooling	
19.480 FS/M, FRS/M-WW	353 kW		02/06→		8MV 376 757-231	500
26.440 FDLC-WW, FDLRC-WW	324 kW		02/06→		Clutch, radiator fan	
26.440 FDS, FDLS, FDLRS-WW, FDLRS-WW	324 kW		02/06→		8MV 376 757-261	500
					Clutch, radiator fan	
					8MV 376 757-661	501
					Clutch, radiator fan	
33.440 FDAC, FDHC	324 kW		06/05→		8MV 376 757-721 Fan	506
33.440 FDK, FDHK	324 kW		06/05→		Wheel, engine cooling	
33.440 FDAS, FDHS	324 kW		06/05→		8MV 376 757-721 Fan	506
40.440 FDK-WW, FDRK	324 kW		06/05→		Wheel, engine cooling	
40.440 FDS-WW, FDRS	324 kW		06/05→		8MV 376 758-561 Fan	507
40.480 FDK-WW, FDRK	353 kW		06/05→		Wheel, engine cooling	
40.480 FDS-WW; FDRS	353 kW		06/05→		8MV 376 758-571 Fan	508
41.440 FFD/M	324 kW		12/04→		Wheel, engine cooling	
41.440 FFDC, FFDC	324 kW		12/04→		8MV 376 758-571 Fan	508
41.440 FFDC-TM, FFDC-TM	324 kW		09/07→		Wheel, engine cooling	
41.440 FFDK, FFDK	324 kW		12/04→			
41.480 FFD	353 kW		12/08→			
41.480 FFDC-TM, FFDC-TM	353 kW		09/07→			
19.460 FS/M-WW, FRS/M-WW	338 kW		05/04→	Depth [mm]: 42; L 845 mm; Vers. produced by BEHR; W 938 mm Ø 245 mm; 2 ports Bore Ø [mm]: 152; Depth [mm]: 128; Ø 190 mm; Number of mounting bores: 6; 2 pol; elec. Bore Ø [mm]: 200; Depth [mm]: 138; Ø 236 mm; Number of mounting bores: 6; 2 pol; elec. Bore Ø [mm]: 200; Depth [mm]: 105; Ø 236 mm; Number of mounting bores: 6; 2 pol; elec. Bore Ø [mm]: 152; Diameter 1 [mm]: 704; Diameter 2 [mm]: 127; Number of Fan Blades: 9; Number of mounting bores: 6 Bore Ø [mm]: 200; Diameter 1 [mm]: 750; Diameter 2 [mm]: 180; Number of Fan Blades: 9	8MK 376 728-661	513
40.460 FDK-WW	338 kW		04/04→		Radiator, engine cooling	
40.460 FDS-WW	338 kW		04/04→		8MV 376 757-251	500
					Clutch, radiator fan	
					8MV 376 758-491	503
					Clutch, radiator fan	
					8MV 376 758-511	503
					Clutch, radiator fan	
				8MV 376 758-531	504	
				Clutch, radiator fan		
				8MV 376 758-561 Fan	507	
				Wheel, engine cooling		
				8MV 376 758-571 Fan	508	
				Wheel, engine cooling		

Manufacturer - Model	Power	Displ.	Year of Constr.	Remark	Part Number	Page
MAN - TGA						04/00→
19.480 FS/M-WW, FRS/M-WW	353 kW		05/04→	Depth [mm]: 42; L 845 mm; Vers. produced by BEHR; W 938 mm	8MK 376 728-661 Radiator, engine cooling	513
40.480 FDK-WW	353 kW		04/04→			
40.480 FDS-WW	353 kW		04/04→	Ø 245 mm; 2 ports	8MV 376 757-251 Clutch, radiator fan	500
				Bore Ø [mm]: 200; Depth [mm]: 105; Ø 236 mm; Number of mounting bores: 6; 2 pol; elec.	8MV 376 758-531 Clutch, radiator fan	504
				Bore Ø [mm]: 152; Diameter 1 [mm]: 704; Diameter 2 [mm]: 127; Number of Fan Blades: 9; Number of mounting bores: 6	8MV 376 758-561 Fan Wheel, engine cooling	507
				Bore Ø [mm]: 200; Diameter 1 [mm]: 750; Diameter 2 [mm]: 180; Number of Fan Blades: 9	8MV 376 758-571 Fan Wheel, engine cooling	508
26.280 FNLC, FNLLC, FNLLW	206 kW		11/02→	Bore Ø [mm]: 152; Depth [mm]: 128; Ø 190 mm; Number of mounting bores: 6; 2 pol; elec.	8MV 376 758-471 Clutch, radiator fan	502
				Bore Ø [mm]: 152; Diameter 1 [mm]: 704; Diameter 2 [mm]: 127; Number of Fan Blades: 9; Number of mounting bores: 6	8MV 376 758-561 Fan Wheel, engine cooling	507
				Bore Ø [mm]: 200; Diameter 1 [mm]: 750; Diameter 2 [mm]: 180; Number of Fan Blades: 9	8MV 376 758-571 Fan Wheel, engine cooling	508
26.310 FDAC	228 kW		01/04→	Depth [mm]: 42; L 920 mm; Vers. produced by BEHR; W 938 mm	8MK 376 721-681 Radiator, engine cooling	510
26.310 FDAK	228 kW		01/04→			
26.310 FDAS	228 kW		01/04→	Depth [mm]: 42; L 845 mm; Vers. produced by BEHR; W 938 mm	8MK 376 728-661 Radiator, engine cooling	513
26.320 FDAC	235 kW		04/06→			
26.320 FDAK	235 kW		04/06→	Depth [mm]: 52; L 938 mm; Vers. produced by BEHR; W 844 mm	8MK 376 756-011 Radiator, engine cooling	518
26.320 FDAS	235 kW		04/06→			
26.350 FDAC	257 kW		02/04→	Ø 270 mm; 5 ports	8MV 376 757-231 Clutch, radiator fan	500
26.350 FDAK	257 kW		02/04→			
26.350 FDAS	257 kW		02/04→			
26.360 FDAC, FDARC	265 kW		06/04→	for tropical climates; Ø 245 mm; 2 ports	8MV 376 757-261 Clutch, radiator fan	500
26.360 FDAK, FDARK	265 kW		06/04→			
26.360 FDAS, FDARS	265 kW		06/04→	Ø 245 mm	8MV 376 757-661 Clutch, radiator fan	501
26.390 FDAC, FDALC	287 kW		01/04→			
26.390 FDAK, FDALK	287 kW		02/04→	Ø 754 mm; + OE 51066010275; Number of Fan Blades: 9	8MV 376 757-721 Fan Wheel, engine cooling	506
26.390 FDAS, FDALS	287 kW		02/04→			
26.400 FDAC, FDALC	294 kW		01/04→	Bore Ø [mm]: 1; Depth [mm]: 128; Ø 190 mm; Number of mounting bores: 6; 2 pol; elec.	8MV 376 758-481 Clutch, radiator fan	502
26.400 FDAK, FDALK	294 kW		01/04→			
26.400 FDAS, FDALS	294 kW		01/04→	Bore Ø [mm]: 152; Diameter 1 [mm]: 704; Diameter 2 [mm]: 127; Number of Fan Blades: 9; Number of mounting bores: 6	8MV 376 758-561 Fan Wheel, engine cooling	507
26.430 FDAC, FDALC	316 kW		01/04→			
26.430 FDAK, FDALK	316 kW		01/04→	Bore Ø [mm]: 200; Diameter 1 [mm]: 750; Diameter 2 [mm]: 180; Number of Fan Blades: 9	8MV 376 758-571 Fan Wheel, engine cooling	508
26.430 FDAS, FDALS	316 kW		01/04→			
26.440 FDAC, FDALC	324 kW		09/05→			
26.440 FDAK, FDALK	324 kW		01/04→			
26.440 FDAS, FDALS	324 kW		01/04→			
26.330 FNLC, FNLLC, FNLLW	240 kW		11/02→	Bore Ø [mm]: 152; Diameter 1 [mm]: 704; Diameter 2 [mm]: 127; Number of Fan Blades: 9; Number of mounting bores: 6	8MV 376 758-561 Fan Wheel, engine cooling	507
				Bore Ø [mm]: 200; Diameter 1 [mm]: 750; Diameter 2 [mm]: 180; Number of Fan Blades: 9	8MV 376 758-571 Fan Wheel, engine cooling	508
26.480 FDAC, FDALC	353 kW		02/06→	Depth [mm]: 42; L 920 mm; Vers. produced by BEHR; W 938 mm	8MK 376 721-681 Radiator, engine cooling	510
26.480 FDAK, FDALK	353 kW		02/06→			
26.480 FDAS, FDALS	353 kW		02/06→	Depth [mm]: 42; L 845 mm; Vers. produced by BEHR; W 938 mm	8MK 376 728-661 Radiator, engine cooling	513
				Depth [mm]: 52; L 938 mm; Vers. produced by BEHR; W 844 mm	8MK 376 756-011 Radiator, engine cooling	518
				Ø 270 mm; 5 ports	8MV 376 757-231 Clutch, radiator fan	500
				for tropical climates; Ø 245 mm; 2 ports	8MV 376 757-261 Clutch, radiator fan	500
				Ø 245 mm	8MV 376 757-661 Clutch, radiator fan	501
				Bore Ø [mm]: 152; Diameter 1 [mm]: 704; Diameter 2 [mm]: 127; Number of Fan Blades: 9; Number of mounting bores: 6	8MV 376 758-561 Fan Wheel, engine cooling	507
				Bore Ø [mm]: 200; Diameter 1 [mm]: 750; Diameter 2 [mm]: 180; Number of Fan Blades: 9	8MV 376 758-571 Fan Wheel, engine cooling	508
27.440 FDS, FDLS, FDRS, FDLRS	324 kW		10/08→	Ø 270 mm; 5 ports	8MV 376 757-231 Clutch, radiator fan	500
				for tropical climates; Ø 245 mm; 2 ports	8MV 376 757-261 Clutch, radiator fan	500
				Ø 245 mm	8MV 376 757-661 Clutch, radiator fan	501
				Ø 754 mm; + OE 51066010275; Number of Fan Blades: 9	8MV 376 757-721 Fan Wheel, engine cooling	506
				Bore Ø [mm]: 152; Diameter 1 [mm]: 704; Diameter 2 [mm]: 127; Number of Fan Blades: 9; Number of mounting bores: 6	8MV 376 758-561 Fan Wheel, engine cooling	507
				Bore Ø [mm]: 200; Diameter 1 [mm]: 750; Diameter 2 [mm]: 180; Number of Fan Blades: 9	8MV 376 758-571 Fan Wheel, engine cooling	508

Manufacturer - Model	Power	Displ.	Year of Constr.	Remark	Part Number	Page
MAN - TGA						04/00→
28.310 FNLC, FNLLC, FNLRC	228 kW		09/02→	Depth [mm]: 42; L 920 mm; Vers. produced by BEHR; W 938 mm	8MK 376 721-681 Radiator, engine cooling	510
				Depth [mm]: 42; L 845 mm; Vers. produced by BEHR; W 938 mm	8MK 376 728-661 Radiator, engine cooling	513
				Depth [mm]: 52; L 938 mm; Vers. produced by BEHR; W 844 mm	8MK 376 756-011 Radiator, engine cooling	518
				Depth [mm]: 52; L 938 mm; Vers. produced by BEHR; W 919 mm	8MK 376 756-021 Radiator, engine cooling	518
				Ø 270 mm; 5 ports	8MV 376 757-231 Clutch, radiator fan	500
				Ø 245 mm; 2 ports	8MV 376 757-251 Clutch, radiator fan	500
				for tropical climates; Ø 245 mm; 2 ports	8MV 376 757-261 Clutch, radiator fan	500
				Ø 245 mm	8MV 376 757-661 Clutch, radiator fan	501
				Ø 754 mm; + OE 51066010275; Number of Fan Blades: 9	8MV 376 757-721 Fan Wheel, engine cooling	506
				Bore Ø [mm]: 1; Depth [mm]: 128; Ø 190 mm; Number of mounting bores: 6; 2 pol; elec.	8MV 376 758-481 Clutch, radiator fan	502
				Bore Ø [mm]: 152; Depth [mm]: 128; Ø 190 mm; Number of mounting bores: 6; 2 pol; elec.	8MV 376 758-491 Clutch, radiator fan	503
				Bore Ø [mm]: 200; Depth [mm]: 138; Ø 236 mm; Number of mounting bores: 6; 2 pol; elec.	8MV 376 758-511 Clutch, radiator fan	503
				Bore Ø [mm]: 152; Diameter 1 [mm]: 704; Diameter 2 [mm]: 127; Number of Fan Blades: 9; Number of mounting bores: 6	8MV 376 758-561 Fan Wheel, engine cooling	507
				Bore Ø [mm]: 200; Diameter 1 [mm]: 750; Diameter 2 [mm]: 180; Number of Fan Blades: 9	8MV 376 758-571 Fan Wheel, engine cooling	508
28.350 FANLC	257 kW		07/06→	Depth [mm]: 42; L 845 mm; Vers. produced by BEHR; W 938 mm	8MK 376 728-661 Radiator, engine cooling	513
28.350 FANLK	257 kW		07/06→			
28.390 FANLC	287 kW		07/06→	Depth [mm]: 52; L 938 mm; Vers. produced by BEHR; W 844 mm	8MK 376 756-011 Radiator, engine cooling	518
28.390 FANLK	287 kW		07/06→			
28.400 FANLC	294 kW		07/06→	Ø 270 mm; 5 ports	8MV 376 757-231 Clutch, radiator fan	500
28.430 FANLC	316 kW		07/06→			
28.430 FANLK	316 kW		07/06→			
28.440 FANLC	324 kW		07/06→	for tropical climates; Ø 245 mm; 2 ports	8MV 376 757-261 Clutch, radiator fan	500
28.440 FANLK	324 kW		07/06→			
32.350, 32.360 FFDRC	257 - 265 kW		05/04→	Ø 245 mm	8MV 376 757-661 Clutch, radiator fan	501
32.350, 32.360 FFD-TM, FFDR-TM	257 - 265 kW		02/04→			
32.390, 32.400 FFDRC	287 - 294 kW		05/04→	Ø 754 mm; + OE 51066010275; Number of Fan Blades: 9	8MV 376 757-721 Fan Wheel, engine cooling	506
32.390, 32.400 FFD-TM, FFDR-TM	287 - 294 kW		05/04→			
32.430, 32.440 FFDRC	316 - 324 kW		05/04→	Bore Ø [mm]: 1; Depth [mm]: 128; Ø 190 mm; Number of mounting bores: 6; 2 pol; elec.	8MV 376 758-481 Clutch, radiator fan	502
32.430, 32.440 FFD-TM, FFDR-TM	316 - 324 kW		05/04→			
35.310, 35.320 FFDK, FFDLC	228 - 235 kW		02/04→	Bore Ø [mm]: 152; Diameter 1 [mm]: 704; Diameter 2 [mm]: 127; Number of Fan Blades: 9; Number of mounting bores: 6	8MV 376 758-561 Fan Wheel, engine cooling	507
35.310, 35.320 FFDK, FFDLC	228 - 235 kW		02/04→			
35.310, 35.320 FFD-TM	228 - 235 kW		02/04→			
35.350, 35.360 FFDK, FFDRC, FFDLC	257 - 265 kW		02/04→	Bore Ø [mm]: 200; Diameter 1 [mm]: 750; Diameter 2 [mm]: 180; Number of Fan Blades: 9	8MV 376 758-571 Fan Wheel, engine cooling	508
35.350, 35.360 FFDK, FFDRC, FFDLC	257 - 265 kW		02/04→			
35.350, 35.360 FFDK, FFDRC, FFDLC	257 - 265 kW		02/04→			
35.350, 35.360 FFD-TM	257 - 265 kW		02/04→			
35.350 FFDHK, FFDHLK	257 kW		07/06→			
35.350 FFDH-TM	257 kW		07/06→			
35.350 FFNLC	257 kW		07/06→			
35.360 FFDHK, FFDHLK	265 kW		07/06→			
35.360 FFDH-TM	265 kW		07/06→			
35.360 FFNHLC	265 kW		07/06→			
35.390, 35.400 FFDK, FFDRC, FFDLC	287 - 294 kW		02/04→			
35.390, 35.400 FFDK, FFDRC, FFDLC	287 - 294 kW		02/04→			
35.390, 35.400 FFD-TM	287 - 294 kW		02/04→			
35.390 FFDK	287 kW		02/04→			
35.390 FFDK, FFDHK, FFDHLK	287 kW		07/06→			
35.390 FFDH-TM	287 kW		07/06→			
35.390 FFNLC	287 kW		07/06→			
35.400 FFDK	294 kW		02/04→			
35.400 FFDK, FFDHK, FFDHLK	294 kW		07/06→			
35.400 FFDH-TM	294 kW		07/06→			
35.400 FFNHLC	294 kW		11/06→			
35.400 FFNLC	294 kW		07/06→			
35.430, 35.440 FFDK, FFDRC, FFDLC	316 - 324 kW		02/04→			

Manufacturer - Model	Power	Displ.	Year of Constr.	Remark	Part Number	Page
MAN - TGA						04/00→
35.430, 35.440 FFDK, FFDK, FFDLK	316 - 324 kW		02/04→	Depth [mm]: 42; L 845 mm; Vers. produced by BEHR; W 938 mm	8MK 376 728-661 Radiator, engine cooling	513
35.430, 35.440 FFD-TM	316 - 324 kW		02/04→	Depth [mm]: 52; L 938 mm; Vers. produced by BEHR; W 844 mm	8MK 376 756-011 Radiator, engine cooling	518
35.430 FFDH-TM	316 kW		07/06→	Ø 270 mm; 5 ports	8MV 376 757-231 Clutch, radiator fan	500
35.430 FFDH-TM	316 kW		07/06→		8MV 376 757-261 Clutch, radiator fan	500
35.440 FFDK, FFDH, FFDHLK	324 kW		07/06→	for tropical climates; Ø 245 mm; 2 ports	8MV 376 757-261 Clutch, radiator fan	500
35.440 FFDH-TM	324 kW		07/06→	Ø 245 mm	8MV 376 757-661 Clutch, radiator fan	501
35.440 FFDH-TM	324 kW		11/06→		8MV 376 757-721 Fan Wheel, engine cooling	506
35.440 FFDH-TM	324 kW		11/06→	Ø 754 mm; + OE 51066010275; Number of Fan Blades: 9	8MV 376 758-481 Clutch, radiator fan	502
35.440 FFDH-TM	324 kW		07/06→	Bore Ø [mm]: 1; Depth [mm]: 128; Ø 190 mm; Number of mounting bores: 6; 2 pol; elec.	8MV 376 758-481 Clutch, radiator fan	502
37.310, 37.320 FFDK	228 - 235 kW		12/04→	Bore Ø [mm]: 152; Diameter 1 [mm]: 704; Diameter 2 [mm]: 127; Number of Fan Blades: 9; Number of mounting bores: 6	8MV 376 758-561 Fan Wheel, engine cooling	507
37.310, 37.320 FFDK	228 - 235 kW		12/04→	Bore Ø [mm]: 200; Diameter 1 [mm]: 750; Diameter 2 [mm]: 180; Number of Fan Blades: 9	8MV 376 758-571 Fan Wheel, engine cooling	508
37.310, 37.320 FFD-TM	228 - 235 kW		12/04→			
37.350, 37.360 FFDK	257 - 265 kW		12/04→			
37.350, 37.360 FFDK	257 - 265 kW		12/04→			
37.350, 37.360 FFD-TM	257 - 265 kW		12/04→			
37.390, 37.400 FFDK	287 - 294 kW		12/04→			
37.390, 37.400 FFDK	287 - 294 kW		12/04→			
37.390, 37.400 FFD-TM	287 - 294 kW		12/04→			
37.430, 37.440 FFDK	316 - 324 kW		12/04→			
37.430, 37.440 FFD-TM	316 - 324 kW		12/04→			
40.390, 40.400 FDK-WW	287 - 294 kW		06/05→			
40.390, 40.400 FDK-WW	287 - 294 kW		06/05→			
40.430, 40.440 FDK-WW	316 - 324 kW		06/05→			
40.430, 40.440 FDK-WW	316 - 324 kW		06/05→			
41.350, 41.360 FFDK, FFDK/M, FFDRC	257 - 265 kW		12/04→			
41.350, 41.360 FFDK, FFDK	257 - 265 kW		12/04→			
41.350, 41.360 FFD-TM	257 - 265 kW		12/04→			
41.390, 41.400 FFDK, FFDRC, FFDK/M	287 - 294 kW		12/04→			
41.390, 41.400 FFDK, FFDK	287 - 294 kW		12/04→			
41.390, 41.400 FFD-TM	287 - 294 kW		12/04→			
41.390 FFDK	287 kW		12/04→			
41.430, 41.440 FFDK, FFDRC, FFDK/M	316 - 324 kW		12/04→			
41.430, 41.440 FFDK, FFDK	316 - 324 kW		12/04→			
41.430 FFDK	316 kW		12/04→			
41.430 FFDK	316 kW		07/06→			
41.440 FFDK	324 kW		07/06→			
28.360 FANLC	265 kW		07/06→	Depth [mm]: 42; L 920 mm; Vers. produced by BEHR; W 938 mm	8MK 376 721-681 Radiator, engine cooling	510
28.360 FANLC	265 kW		07/06→	Depth [mm]: 42; L 845 mm; Vers. produced by BEHR; W 938 mm	8MK 376 728-661 Radiator, engine cooling	513
35.360 FFDK	265 kW		07/06→	Depth [mm]: 52; L 938 mm; Vers. produced by BEHR; W 844 mm	8MK 376 756-011 Radiator, engine cooling	518
				Ø 270 mm; 5 ports	8MV 376 757-231 Clutch, radiator fan	500
				Ø 245 mm; 2 ports	8MV 376 757-251 Clutch, radiator fan	500
				for tropical climates; Ø 245 mm; 2 ports	8MV 376 757-261 Clutch, radiator fan	500
				Ø 245 mm	8MV 376 757-661 Clutch, radiator fan	501
				Ø 754 mm; + OE 51066010275; Number of Fan Blades: 9	8MV 376 757-721 Fan Wheel, engine cooling	506
				Bore Ø [mm]: 1; Depth [mm]: 128; Ø 190 mm; Number of mounting bores: 6; 2 pol; elec.	8MV 376 758-481 Clutch, radiator fan	502
				Bore Ø [mm]: 152; Depth [mm]: 128; Ø 190 mm; Number of mounting bores: 6; 2 pol; elec.	8MV 376 758-491 Clutch, radiator fan	503
				Bore Ø [mm]: 200; Depth [mm]: 138; Ø 236 mm; Number of mounting bores: 6; 2 pol; elec.	8MV 376 758-511 Clutch, radiator fan	503
				Bore Ø [mm]: 152; Diameter 1 [mm]: 704; Diameter 2 [mm]: 127; Number of Fan Blades: 9; Number of mounting bores: 6	8MV 376 758-561 Fan Wheel, engine cooling	507
				Bore Ø [mm]: 200; Diameter 1 [mm]: 750; Diameter 2 [mm]: 180; Number of Fan Blades: 9	8MV 376 758-571 Fan Wheel, engine cooling	508
28.480 FANLC	353 kW		07/06→	Depth [mm]: 42; L 920 mm; Vers. produced by BEHR; W 938 mm	8MK 376 721-681 Radiator, engine cooling	510
				Depth [mm]: 42; L 845 mm; Vers. produced by BEHR; W 938 mm	8MK 376 728-661 Radiator, engine cooling	513
				Depth [mm]: 52; L 938 mm; Vers. produced by BEHR; W 844 mm	8MK 376 756-011 Radiator, engine cooling	518
				Ø 270 mm; 5 ports	8MV 376 757-231 Clutch, radiator fan	500
				Ø 245 mm; 2 ports	8MV 376 757-251 Clutch, radiator fan	500

Manufacturer - Model	Power	Displ.	Year of Constr.	Remark	Part Number	Page
MAN - TGA						04/00→
28.480 FANLC	353 kW		07/06→	for tropical climates; Ø 245 mm; 2 ports	8MV 376 757-261	500
					Clutch, radiator fan	
				Ø 245 mm	8MV 376 757-661	501
					Clutch, radiator fan	
				Bore Ø [mm]: 152; Diameter 1 [mm]: 704; Diameter 2 [mm]: 127; Number of Fan Blades: 9; Number of mounting bores: 6	8MV 376 758-561 Fan	507
					Wheel, engine cooling	
				Bore Ø [mm]: 200; Diameter 1 [mm]: 750; Diameter 2 [mm]: 180; Number of Fan Blades: 9	8MV 376 758-571 Fan	508
					Wheel, engine cooling	
28.480 FANLK	353 kW		07/06→	Depth [mm]: 42; L 920 mm; Vers. produced by BEHR; W 938 mm	8MK 376 721-681	510
35.480 FFDK	353 kW		07/06→		Radiator, engine cooling	
35.480 FFNLC	353 kW		07/06→	Depth [mm]: 42; L 845 mm; Vers. produced by BEHR; W 938 mm	8MK 376 728-661	513
41.480 FFDK	353 kW		07/06→		Radiator, engine cooling	
				Depth [mm]: 52; L 938 mm; Vers. produced by BEHR; W 844 mm	8MK 376 756-011	518
					Radiator, engine cooling	
				Ø 270 mm; 5 ports	8MV 376 757-231	500
					Clutch, radiator fan	
				Ø 245 mm; 2 ports	8MV 376 757-251	500
					Clutch, radiator fan	
				for tropical climates; Ø 245 mm; 2 ports	8MV 376 757-261	500
					Clutch, radiator fan	
				Ø 245 mm	8MV 376 757-661	501
					Clutch, radiator fan	
				Bore Ø [mm]: 200; Depth [mm]: 105; Ø 236 mm; Number of mounting bores: 6; 2 pol; elec.	8MV 376 758-531	504
					Clutch, radiator fan	
				Bore Ø [mm]: 152; Diameter 1 [mm]: 704; Diameter 2 [mm]: 127; Number of Fan Blades: 9; Number of mounting bores: 6	8MV 376 758-561 Fan	507
					Wheel, engine cooling	
				Bore Ø [mm]: 200; Diameter 1 [mm]: 750; Diameter 2 [mm]: 180; Number of Fan Blades: 9	8MV 376 758-571 Fan	508
					Wheel, engine cooling	
				Depth [mm]: 42; L 845 mm; Vers. produced by BEHR; W 938 mm	8MK 376 728-661	513
					Radiator, engine cooling	
Depth [mm]: 52; L 938 mm; Vers. produced by BEHR; W 844 mm	8MK 376 756-011	518				
	Radiator, engine cooling					
32.480 FFDRC	353 kW		02/06→	Ø 270 mm; 5 ports	8MV 376 757-231	500
32.480 FFD-TM, FFDR-TM	353 kW		02/06→		Clutch, radiator fan	
35.480 FFDK, FFDLC	353 kW		02/04→			
35.480 FFDK, FFDLK	353 kW		02/04→			
37.480 FFDK	353 kW		02/06→			
37.480 FFDK	353 kW		02/06→			
37.480 FFD-TM	353 kW		02/06→			
40.440 FDK-WW	324 kW		06/05→	for tropical climates; Ø 245 mm; 2 ports	8MV 376 757-261	500
40.440 FDK-WW	324 kW		06/05→		Clutch, radiator fan	
40.480 FDK-WW	353 kW		06/05→	Ø 245 mm	8MV 376 757-661	501
40.480 FDK-WW	353 kW		06/05→		Clutch, radiator fan	
40.480 FDK-WW	353 kW		06/05→			
41.480 FFDK, FFDRC, FFDK/M	353 kW		02/06→	Ø 754 mm; + OE 51066010275; Number of Fan Blades: 9	8MV 376 757-721 Fan	506
41.480 FFDK, FFDRC	353 kW		02/06→		Wheel, engine cooling	
41.480 FFD-TM	353 kW		02/06→	Bore Ø [mm]: 152; Diameter 1 [mm]: 704; Diameter 2 [mm]: 127; Number of Fan Blades: 9; Number of mounting bores: 6	8MV 376 758-561 Fan	507
					Wheel, engine cooling	
				Bore Ø [mm]: 200; Diameter 1 [mm]: 750; Diameter 2 [mm]: 180; Number of Fan Blades: 9	8MV 376 758-571 Fan	508
					Wheel, engine cooling	
33.350 FDK-TM, FDK-TM	257 kW		09/07→	Depth [mm]: 42; L 920 mm; Vers. produced by BEHR; W 938 mm	8MK 376 721-681	510
33.360 FDK-TM, FDK-TM	265 kW		09/07→		Radiator, engine cooling	
33.390, 33.400 FDK-TM, FDK-TM	287 - 294 kW		09/07→	Depth [mm]: 42; L 845 mm; Vers. produced by BEHR; W 938 mm	8MK 376 728-661	513
					Radiator, engine cooling	
				Ø 270 mm; 5 ports	8MV 376 757-231	500
					Clutch, radiator fan	
				for tropical climates; Ø 245 mm; 2 ports	8MV 376 757-261	500
					Clutch, radiator fan	
				Ø 245 mm	8MV 376 757-661	501
					Clutch, radiator fan	
				Ø 754 mm; + OE 51066010275; Number of Fan Blades: 9	8MV 376 757-721 Fan	506
					Wheel, engine cooling	
				Bore Ø [mm]: 1; Depth [mm]: 128; Ø 190 mm; Number of mounting bores: 6; 2 pol; elec.	8MV 376 758-481	502
					Clutch, radiator fan	
				Bore Ø [mm]: 152; Diameter 1 [mm]: 704; Diameter 2 [mm]: 127; Number of Fan Blades: 9; Number of mounting bores: 6	8MV 376 758-561 Fan	507
					Wheel, engine cooling	
				Bore Ø [mm]: 200; Diameter 1 [mm]: 750; Diameter 2 [mm]: 180; Number of Fan Blades: 9	8MV 376 758-571 Fan	508
					Wheel, engine cooling	
33.440 FDK, FDK	324 kW		06/05→	Depth [mm]: 42; L 920 mm; Vers. produced by BEHR; W 938 mm	8MK 376 721-681	510
33.440 FDK-TM, FDK-TM	324 kW		09/07→		Radiator, engine cooling	
33.440 FDK, FDK	324 kW		06/05→	Depth [mm]: 42; L 845 mm; Vers. produced by BEHR; W 938 mm	8MK 376 728-661	513
33.440 FDK, FDK	324 kW		06/05→		Radiator, engine cooling	
33.480 FDK-TM, FDK-TM	353 kW		09/07→	Ø 270 mm; 5 ports	8MV 376 757-231	500
					Clutch, radiator fan	
				for tropical climates; Ø 245 mm; 2 ports	8MV 376 757-261	500
					Clutch, radiator fan	
				Ø 245 mm	8MV 376 757-661	501
					Clutch, radiator fan	

Manufacturer - Model	Power	Displ.	Year of Constr.	Remark	Part Number	Page
MAN - TGA						04/00→
33.440 FDC, FDRC	324 kW		06/05→	Ø 754 mm; + OE 51066010275; Number of Fan Blades: 9	8MV 376 757-721 Fan Wheel, engine cooling	506
33.440 FDC-TM, FDRC-TM	324 kW		09/07→			
33.440 FDK, FDRK	324 kW		06/05→	Bore Ø [mm]: 152; Diameter 1 [mm]: 704; Diameter 2 [mm]: 127; Number of Fan Blades: 9; Number of mounting bores: 6	8MV 376 758-561 Fan Wheel, engine cooling	507
33.440 FDS, FDRS	324 kW		06/05→			
33.480 FDC-TM, FDRC-TM	353 kW		09/07→	Bore Ø [mm]: 200; Diameter 1 [mm]: 750; Diameter 2 [mm]: 180; Number of Fan Blades: 9	8MV 376 758-571 Fan Wheel, engine cooling	508
35.480 FDNLC	353 kW		07/06→	Depth [mm]: 42; L 920 mm; Vers. produced by BEHR; W 938 mm	8MK 376 721-681 Radiator, engine cooling	510
				Depth [mm]: 42; L 845 mm; Vers. produced by BEHR; W 938 mm	8MK 376 728-661 Radiator, engine cooling	513
				Depth [mm]: 52; L 938 mm; Vers. produced by BEHR; W 844 mm	8MK 376 756-011 Radiator, engine cooling	518
				Depth [mm]: 52; L 938 mm; Vers. produced by BEHR; W 919 mm	8MK 376 756-021 Radiator, engine cooling	518
				Ø 270 mm; 5 ports	8MV 376 757-231 Clutch, radiator fan	500
				Ø 245 mm; 2 ports	8MV 376 757-251 Clutch, radiator fan	500
				for tropical climates; Ø 245 mm; 2 ports	8MV 376 757-261 Clutch, radiator fan	500
				Ø 245 mm	8MV 376 757-661 Clutch, radiator fan	501
				Bore Ø [mm]: 200; Depth [mm]: 105; Ø 236 mm; Number of mounting bores: 6; 2 pol; elec.	8MV 376 758-531 Clutch, radiator fan	504
				Bore Ø [mm]: 152; Diameter 1 [mm]: 704; Diameter 2 [mm]: 127; Number of Fan Blades: 9; Number of mounting bores: 6	8MV 376 758-561 Fan Wheel, engine cooling	507
Bore Ø [mm]: 200; Diameter 1 [mm]: 750; Diameter 2 [mm]: 180; Number of Fan Blades: 9	8MV 376 758-571 Fan Wheel, engine cooling	508				
35.480 FFD-TM	353 kW		02/04→	Depth [mm]: 42; L 845 mm; Vers. produced by BEHR; W 938 mm	8MK 376 728-661 Radiator, engine cooling	513
				Depth [mm]: 52; L 938 mm; Vers. produced by BEHR; W 844 mm	8MK 376 756-011 Radiator, engine cooling	518
				Ø 270 mm; 5 ports	8MV 376 757-231 Clutch, radiator fan	500
				for tropical climates; Ø 245 mm; 2 ports	8MV 376 757-261 Clutch, radiator fan	500
				Ø 754 mm; + OE 51066010275; Number of Fan Blades: 9	8MV 376 757-721 Fan Wheel, engine cooling	506
				Bore Ø [mm]: 152; Diameter 1 [mm]: 704; Diameter 2 [mm]: 127; Number of Fan Blades: 9; Number of mounting bores: 6	8MV 376 758-561 Fan Wheel, engine cooling	507
				Bore Ø [mm]: 200; Diameter 1 [mm]: 750; Diameter 2 [mm]: 180; Number of Fan Blades: 9	8MV 376 758-571 Fan Wheel, engine cooling	508
37.430, 37.440 FFDK	316 - 324 kW		12/04→	Depth [mm]: 42; L 845 mm; Vers. produced by BEHR; W 938 mm	8MK 376 728-661 Radiator, engine cooling	513
				Depth [mm]: 52; L 938 mm; Vers. produced by BEHR; W 844 mm	8MK 376 756-011 Radiator, engine cooling	518
				Ø 270 mm; 5 ports	8MV 376 757-231 Clutch, radiator fan	500
				for tropical climates; Ø 245 mm; 2 ports	8MV 376 757-261 Clutch, radiator fan	500
				Ø 754 mm; + OE 51066010275; Number of Fan Blades: 9	8MV 376 757-721 Fan Wheel, engine cooling	506
				Bore Ø [mm]: 1; Depth [mm]: 128; Ø 190 mm; Number of mounting bores: 6; 2 pol; elec.	8MV 376 758-481 Clutch, radiator fan	502
				Bore Ø [mm]: 152; Diameter 1 [mm]: 704; Diameter 2 [mm]: 127; Number of Fan Blades: 9; Number of mounting bores: 6	8MV 376 758-561 Fan Wheel, engine cooling	507
				Bore Ø [mm]: 200; Diameter 1 [mm]: 750; Diameter 2 [mm]: 180; Number of Fan Blades: 9	8MV 376 758-571 Fan Wheel, engine cooling	508
37.530 FVDS, FVDLS	390 kW		07/06→	Depth [mm]: 42; L 920 mm; Vers. produced by BEHR; W 938 mm	8MK 376 721-681 Radiator, engine cooling	510
				Depth [mm]: 42; L 845 mm; Vers. produced by BEHR; W 938 mm	8MK 376 728-661 Radiator, engine cooling	513
				Ø 245 mm; 2 ports	8MV 376 757-251 Clutch, radiator fan	500
				Ø 754 mm; + OE 51066010275; Number of Fan Blades: 9	8MV 376 757-721 Fan Wheel, engine cooling	506
				Bore Ø [mm]: 200; Depth [mm]: 105; Ø 236 mm; Number of mounting bores: 6; 2 pol; elec.	8MV 376 758-531 Clutch, radiator fan	504
				Bore Ø [mm]: 152; Diameter 1 [mm]: 704; Diameter 2 [mm]: 127; Number of Fan Blades: 9; Number of mounting bores: 6	8MV 376 758-561 Fan Wheel, engine cooling	507

Manufacturer - Model	Power	Displ.	Year of Constr.	Remark	Part Number	Page
MAN - TGA						04/00→
37.530 FVDS, FVDLS	390 kW		07/06→	Bore Ø [mm]: 200; Diameter 1 [mm]: 750; Diameter 2 [mm]: 180; Number of Fan Blades: 9	8MV 376 758-571 Fan Wheel, engine cooling	508
40.480 FDAS-WW	353 kW		04/04→	Depth [mm]: 42; L 920 mm; Vers. produced by BEHR; W 938 mm	8MK 376 721-681 Radiator, engine cooling	510
				Depth [mm]: 42; L 845 mm; Vers. produced by BEHR; W 938 mm	8MK 376 728-661 Radiator, engine cooling	513
				Depth [mm]: 52; L 938 mm; Vers. produced by BEHR; W 844 mm	8MK 376 756-011 Radiator, engine cooling	518
				Ø 245 mm; 2 ports	8MV 376 757-251 Clutch, radiator fan	500
				Bore Ø [mm]: 200; Depth [mm]: 105; Ø 236 mm; Number of mounting bores: 6; 2 pol; elec.	8MV 376 758-531 Clutch, radiator fan	504
				Bore Ø [mm]: 152; Diameter 1 [mm]: 704; Diameter 2 [mm]: 127; Number of Fan Blades: 9; Number of mounting bores: 6	8MV 376 758-561 Fan Wheel, engine cooling	507
41.480 FVDS, FVDLS	353 kW		07/06→	Bore Ø [mm]: 200; Diameter 1 [mm]: 750; Diameter 2 [mm]: 180; Number of Fan Blades: 9	8MV 376 758-571 Fan Wheel, engine cooling	508
				Depth [mm]: 42; L 920 mm; Vers. produced by BEHR; W 938 mm	8MK 376 721-681 Radiator, engine cooling	510
				Depth [mm]: 52; L 938 mm; Vers. produced by BEHR; W 919 mm	8MK 376 756-021 Radiator, engine cooling	518
				Ø 245 mm; 2 ports	8MV 376 757-251 Clutch, radiator fan	500
				Bore Ø [mm]: 200; Depth [mm]: 105; Ø 236 mm; Number of mounting bores: 6; 2 pol; elec.	8MV 376 758-531 Clutch, radiator fan	504
				Bore Ø [mm]: 152; Diameter 1 [mm]: 704; Diameter 2 [mm]: 127; Number of Fan Blades: 9; Number of mounting bores: 6	8MV 376 758-561 Fan Wheel, engine cooling	507
41.530 FVDS, FVDLS	390 kW		09/02→	Bore Ø [mm]: 200; Diameter 1 [mm]: 750; Diameter 2 [mm]: 180; Number of Fan Blades: 9	8MV 376 758-571 Fan Wheel, engine cooling	508
				Depth [mm]: 42; L 920 mm; Vers. produced by BEHR; W 938 mm	8MK 376 721-681 Radiator, engine cooling	510
				Depth [mm]: 52; L 938 mm; Vers. produced by BEHR; W 919 mm	8MK 376 756-021 Radiator, engine cooling	518
				Ø 245 mm; 2 ports	8MV 376 757-251 Clutch, radiator fan	500
				Ø 753 mm; Number of Fan Blades: 9	8MV 376 757-271 Fan, radiator	505
				Bore Ø [mm]: 200; Depth [mm]: 105; Ø 236 mm; Number of mounting bores: 6; 2 pol; elec.	8MV 376 758-531 Clutch, radiator fan	504
41.540 FVDS, FVDLS	397 kW		11/06→	Bore Ø [mm]: 152; Diameter 1 [mm]: 704; Diameter 2 [mm]: 127; Number of Fan Blades: 9; Number of mounting bores: 6	8MV 376 758-561 Fan Wheel, engine cooling	507
				Bore Ø [mm]: 200; Diameter 1 [mm]: 750; Diameter 2 [mm]: 180; Number of Fan Blades: 9	8MV 376 758-571 Fan Wheel, engine cooling	508
				Depth [mm]: 42; L 920 mm; Vers. produced by BEHR; W 938 mm	8MK 376 721-681 Radiator, engine cooling	510
				Depth [mm]: 52; L 938 mm; Vers. produced by BEHR; W 919 mm	8MK 376 756-021 Radiator, engine cooling	518
				Ø 270 mm; 5 ports	8MV 376 757-231 Clutch, radiator fan	500
				for tropical climates; Ø 245 mm; 2 ports	8MV 376 757-261 Clutch, radiator fan	500
41.660 FVDS, FVDLS	485 kW		09/02→	Ø 753 mm; Number of Fan Blades: 9	8MV 376 757-271 Fan, radiator	505
				Ø 245 mm	8MV 376 757-661 Clutch, radiator fan	501
				Bore Ø [mm]: 152; Diameter 1 [mm]: 704; Diameter 2 [mm]: 127; Number of Fan Blades: 9; Number of mounting bores: 6	8MV 376 758-561 Fan Wheel, engine cooling	507
				Bore Ø [mm]: 200; Diameter 1 [mm]: 750; Diameter 2 [mm]: 180; Number of Fan Blades: 9	8MV 376 758-571 Fan Wheel, engine cooling	508
				Ø 245 mm; 2 ports	8MV 376 757-251 Clutch, radiator fan	500
				Ø 753 mm; Number of Fan Blades: 9	8MV 376 757-271 Fan, radiator	505
MAN - TGL						04/05→
10.180 FC, FRC, FLC, FLRC	132 kW		04/05→	Depth [mm]: 40; L 590 mm; Vers. produced by BEHR; W 608 mm	8MK 376 728-671 Radiator, engine cooling	514
10.180 FK, FRK	132 kW		04/05→			
10.210 FC, FRC, FLC, FLRC	151 kW		04/05→			

Manufacturer - Model	Power	Displ.	Year of Constr.	Remark	Part Number	Page
MAN - TGL						04/05→
10.210 FK, FRK	151 kW		04/05→	Depth [mm]: 40; L 705 mm; Vers. produced by BEHR; W 608 mm	8MK 376 730-621	514
10.220 FC, FLC, FRC, FLRC	162 kW		04/05→		Radiator, engine cooling	
10.220 FK, FRK	162 kW		04/05→	Ø 165 mm; + OE 51066300071	8MV 376 757-681	501
12.180 FC, FRC, FLC, FLRC	132 kW		04/05→		Clutch, radiator fan	
12.180 FK, FRK	132 kW		04/05→	Ø 600 mm; + OE 51066010266; Number of Fan Blades: 8	8MV 376 757-731 Fan	507
12.210 FC, FRC, FLC, FLRC	151 kW		04/05→		Wheel, engine cooling	
12.210 FK, FRK	151 kW		04/05→			
12.220 FC, FRC, FLC, FLRC	162 kW		04/05→			
12.220 FK, FRK	162 kW		04/05→			
7.150, 8.150 FC, FRC, FLC, FLRC	110 kW		04/05→			
7.180 FC, FLC, FRC, FLRC	132 kW		04/05→			
8.150 FK, FRK, FK-L, FRK-L	110 kW		10/06→			
8.180 FC, FRC, FLC, FLRC	132 kW		04/05→			
8.180 FK, FK-L, FRK, FRK-L	132 kW		04/05→			
8.210 FC, FRC, FLC, FLRC	151 kW		04/05→			
8.210 FK, FK-L, FRK, FRK-L	151 kW		04/05→			
8.220 FC, FLC, FRC, FLRC	162 kW		04/05→			
8.220 FK, FRK, FK-L, FRK-L	162 kW		04/05→			
10.240 FC, FRC, FLC, FLRC	176 kW		04/05→	Depth [mm]: 40; L 705 mm; Vers. produced by BEHR; W 608 mm	8MK 376 730-621	514
10.240 FK, FRK	176 kW		04/05→		Radiator, engine cooling	
10.250 FC, FLC, FRC, FLRC	184 kW		04/05→	Depth [mm]: 40; L 668 mm; Vers. produced by BEHR; W 950 mm	8MK 376 755-391	515
10.250 FK, FRK	184 kW		04/05→		Radiator, engine cooling	
12.240 FC, FRC, FLC, FLRC	176 kW		04/05→	Depth [mm]: 40; L 668 mm; Vers. produced by BEHR; W 830 mm	8MK 376 755-401	515
12.240 FK, FRK	176 kW		04/05→		Radiator, engine cooling	
12.250 FC, FLC, FRC, FLRC	184 kW		04/05→	Depth [mm]: 40; L 668 mm; Vers. produced by BEHR; W 780 mm	8MK 376 755-411	516
12.250 FK, FRK	184 kW		04/05→		Radiator, engine cooling	
8.240 FC, FRC, FLC, FLRC	176 kW		04/05→	Depth [mm]: 40; L 668 mm; Vers. produced by BEHR; W 900 mm	8MK 376 755-641	517
8.250 FC, FLC, FLRC, FRC	184 kW		04/05→		Radiator, engine cooling	
8.250 FK, FK-L, FRK, FRK-L	184 kW		04/05→			
7.220 FC, FLC, FRC, FLRC	162 kW		04/05→	Ø 165 mm; + OE 51066300071	8MV 376 757-681	501
					Clutch, radiator fan	
				Ø 600 mm; + OE 51066010266; Number of Fan Blades: 8	8MV 376 757-731 Fan	507
					Wheel, engine cooling	
7.250 FC, FLC, FRC, FLRC	184 kW		04/05→	Depth [mm]: 40; L 668 mm; Vers. produced by BEHR; W 830 mm	8MK 376 755-401	515
					Radiator, engine cooling	
				Depth [mm]: 40; L 668 mm; Vers. produced by BEHR; W 900 mm	8MK 376 755-641	517
					Radiator, engine cooling	
8.240 FK, FK-L, FRK, FRK-L	176 kW		04/05→	Depth [mm]: 40; L 705 mm; Vers. produced by BEHR; W 608 mm	8MK 376 730-621	514
					Radiator, engine cooling	
				Depth [mm]: 40; L 668 mm; Vers. produced by BEHR; W 830 mm	8MK 376 755-401	515
					Radiator, engine cooling	
				Depth [mm]: 40; L 668 mm; Vers. produced by BEHR; W 780 mm	8MK 376 755-411	516
					Radiator, engine cooling	
				Depth [mm]: 40; L 668 mm; Vers. produced by BEHR; W 900 mm	8MK 376 755-641	517
					Radiator, engine cooling	
MAN - TGM						10/05→
12.240 FLC, FLLC	176 kW		10/05→	Depth [mm]: 40; L 705 mm; Vers. produced by BEHR; W 608 mm	8MK 376 730-621	514
12.250 FLC, FLLC	184 kW		10/05→		Radiator, engine cooling	
12.280 FC, FLC, FLLC	206 kW		10/05→	Depth [mm]: 40; L 668 mm; Vers. produced by BEHR; W 950 mm	8MK 376 755-391	515
12.290 FLC, FLLC	213 kW		10/05→		Radiator, engine cooling	
13.240 FALK, FALRK, FALK-L, FALRK-L	176 kW		04/06→	Depth [mm]: 40; L 668 mm; Vers. produced by BEHR; W 830 mm	8MK 376 755-401	515
					Radiator, engine cooling	
13.250 FALK, FALRK, FALK-L, FALRK-L	184 kW		10/05→	Depth [mm]: 40; L 668 mm; Vers. produced by BEHR; W 780 mm	8MK 376 755-411	516
					Radiator, engine cooling	
13.280 FALK, FALRK, FALK-L, FALRK-L	206 kW		04/06→	Depth [mm]: 40; L 668 mm; Vers. produced by BEHR; W 900 mm	8MK 376 755-641	517
					Radiator, engine cooling	
13.290 FALK, FALRK, FALK-L, FALRK-L	213 kW		10/05→			
15.240 FC, FLC, FLLC, FLRC, FLLRC	176 kW		10/05→			
15.240 FLK, FLRK	176 kW		10/05→			
15.250 FC, FLC, FLRC, FLLC, FLLRC	184 kW		10/05→			
15.250 FLK, FLRK	184 kW		10/05→			
15.280 FC, FLC, FLLC, FLRC, FLLRC	206 kW		10/05→			
15.280 FLK, FLRK	206 kW		10/05→			
15.290 FC, FLC, FLRC, FLLC, FLLRC	213 kW		10/05→			
15.290 FLK, FLRK	213 kW		10/05→			
15.330 FC, FLC, FRC, FLRC	240 kW		10/05→			
15.330 FLK, FLRK	240 kW		10/05→			
15.340 FC, FLC, FLRC	250 kW		10/05→			
15.340 FLK, FLRK	250 kW		10/05→			
18.240 FAC, FARC	176 kW		10/05→			
18.240 FAK, FARK, FAK-L, FARK-L	176 kW		05/06→			

Manufacturer - Model	Power	Displ.	Year of Constr.	Remark	Part Number	Page
MAN - TGM						10/05→
18.240 FC, FRC, FLC, FLRC, FLLC, FLLRC	176 kW		10/05→	Depth [mm]: 40; L 705 mm; Vers. produced by BEHR; W 608 mm	8MK 376 730-621 Radiator, engine cooling	514
18.240 FK, FRK, FLK, FK-L, FLRK	176 kW		10/05→	Depth [mm]: 40; L 668 mm; Vers. produced by BEHR; W 950 mm	8MK 376 755-391 Radiator, engine cooling	515
18.250 FAC, FARC	184 kW		10/05→	Depth [mm]: 40; L 668 mm; Vers. produced by BEHR; W 830 mm	8MK 376 755-401 Radiator, engine cooling	515
18.250 FAK, FARK, FAK-L, FARK-L	184 kW		10/05→			
18.250 FC, FLC, FLLC, FRC, FLRC, FLLRC	184 kW		10/05→	Depth [mm]: 40; L 668 mm; Vers. produced by BEHR; W 780 mm	8MK 376 755-411 Radiator, engine cooling	516
18.250 FK, FLK, FRK, FLRK	184 kW		10/05→	Depth [mm]: 40; L 668 mm; Vers. produced by BEHR; W 900 mm	8MK 376 755-641 Radiator, engine cooling	517
18.280 FAC, FARC	206 kW		10/05→			
18.280 FAK, FARK, FAK-L, FARK-L	206 kW		10/05→			
18.280 FC, FRC, FLC, FLRC, FLLC, FLLRC	206 kW		10/05→			
18.280 FK, FLK, FRK, FLRK, FK-L	206 kW		10/05→			
18.290 FAC, FARC	213 kW		10/05→			
18.290 FAK, FARK, FAK-L, FARK-L	213 kW		10/05→			
18.290 FC, FLC, FRC, FLRC, FLLC, FLLRC	213 kW		10/05→			
18.290 FK, FLK, FRK, FLRK	213 kW		10/05→			
18.330 FAC, FARC	240 kW		10/05→			
18.330 FAK, FARK, FAK-L, FARK, L	240 kW		10/05→			
18.330 FC, FRC, FLC, FLRC, FLLC, FLLRC	240 kW		10/05→			
18.330 FK, FLK, FRK, FLRK, FK-L	240 kW		10/05→			
18.340 FAC, FARC	250 kW		10/05→			
18.340 FAK, FARK, FAK-L, FARK-L	250 kW		10/05→			
18.340 FC, FLC, FLRC, FLLC, FLLRC, FRC	250 kW		10/05→			
18.340 FK, FRK, FLK, FLRK	250 kW		10/05→			
22.240 FNLLC	176 kW		10/05→			
22.250 FNLLC	184 kW		10/05→			
22.280 FNL, 22.280 FNLLC	206 kW		10/05→			
22.290 FNL, 22.290 FNLLC	213 kW		10/05→			
26.280 FD	206 kW		10/05→			
26.280 FDK-HK, FDRK-HK	206 kW		04/06→			
26.280 FD-TM, FDR-TM	206 kW		04/06→			
26.290 FD, FDR	213 kW		10/05→			
26.290 FDK-HK, FDRK-HK	213 kW		10/05→			
26.290 FD-TM, FDR-TM	213 kW		07/08→			
26.330 FD, FDR	240 kW		10/05→			
26.330 FDK-HK, FDRK-HK	240 kW		04/06→			
26.330 FD-TM, FDR-TM	240 kW		04/06→			
26.340 FD, FDR	250 kW		10/05→			
26.340 FDK-HK, FDRK-HK	250 kW		10/05→			
26.340 FD-TM, FDR-TM	250 kW		07/08→			
13.240 FAL, FALC, FALRC, FAEC, FAERC, FALR	176 kW		04/06→	Depth [mm]: 40; L 705 mm; Vers. produced by BEHR; W 608 mm	8MK 376 730-621 Radiator, engine cooling	514
13.280 FAEC, FAERC, FAL, FALC, FALRC	206 kW		04/06→	Vers. N36,N37; Depth [mm]: 40; L 668 mm; Vers. produced by BEHR; W 950 mm	8MK 376 755-391 Radiator, engine cooling	515
				Depth [mm]: 40; L 668 mm; Vers. produced by BEHR; W 830 mm	8MK 376 755-401 Radiator, engine cooling	515
				Vers. N36,N37; Depth [mm]: 40; L 668 mm; Vers. produced by BEHR; W 780 mm	8MK 376 755-411 Radiator, engine cooling	516
				Depth [mm]: 40; L 668 mm; Vers. produced by BEHR; W 900 mm	8MK 376 755-641 Radiator, engine cooling	517
				Vers. N34; Depth [mm]: 40; L 668 mm; Vers. produced by BEHR; W 780 mm	8MK 376 755-651 Radiator, engine cooling	517
13.250 FAEC, FAERC, FALC, FAL, FALRC, FALR	184 kW		10/05→	Depth [mm]: 40; L 705 mm; Vers. produced by BEHR; W 608 mm	8MK 376 730-621 Radiator, engine cooling	514
13.290 FAEC, FAERC, FAL, FALR, FALC, FALRC	213 kW		10/05→	Vers. N36,N37; Depth [mm]: 40; L 668 mm; Vers. produced by BEHR; W 950 mm	8MK 376 755-391 Radiator, engine cooling	515
				Depth [mm]: 40; L 668 mm; Vers. produced by BEHR; W 830 mm	8MK 376 755-401 Radiator, engine cooling	515
				Vers. N36,N37; Depth [mm]: 40; L 668 mm; Vers. produced by BEHR; W 780 mm	8MK 376 755-411 Radiator, engine cooling	516
				Depth [mm]: 40; L 668 mm; Vers. produced by BEHR; W 900 mm	8MK 376 755-641 Radiator, engine cooling	517
				02/06→; Vers. N34; Depth [mm]: 40; L 668 mm; Vers. produced by BEHR; W 780 mm	8MK 376 755-651 Radiator, engine cooling	517

Manufacturer - Model	Power	Displ.	Year of Constr.	Remark	Part Number	Page
MAN - TGM						10/05→
26.280 FNLC, FNLLC, FNLRC, FNLLRC	206 kW		10/05→	Depth [mm]: 40; L 705 mm; Vers. produced by BEHR; W 608 mm	8MK 376 730-621 Radiator, engine cooling	514
26.290 FNLC, FNLLC, FNLRC, FNLLRC, FVL	213 kW		10/05→	Depth [mm]: 40; L 668 mm; Vers. produced by BEHR; W 950 mm	8MK 376 755-391 Radiator, engine cooling	515
26.330 FNLC, FNLLC, FNLRC, FNLLRC, FVL	240 kW		10/05→	Depth [mm]: 40; L 668 mm; Vers. produced by BEHR; W 900 mm	8MK 376 755-641 Radiator, engine cooling	517
26.340 FNLC, FNLLC, FNLRC, FNLLRC	250 kW		10/05→			
MAN - TGS						09/07→
18.320 FAC, FHLC	235 kW		10/07→	Depth [mm]: 42; L 938 mm; Vers. produced by BEHR; W 765 mm	8MV 376 721-711 Radiator, engine cooling	511
18.320 FAK, FAK-L, FALK, FALK-L, FHLK, FHLK/M	235 kW		10/07→	Depth [mm]: 42; L 845 mm; Vers. produced by BEHR; W 938 mm	8MK 376 728-661 Radiator, engine cooling	513
18.320 FAS, FHLS, FHLS/M	235 kW		10/07→	Depth [mm]: 52; L 938 mm; Vers. produced by BEHR; W 844 mm	8MK 376 756-011 Radiator, engine cooling	518
18.360 FAC, FHLC	265 kW		10/07→	Ø 270 mm; 5 ports	8MV 376 757-231 Clutch, radiator fan	500
18.360 FAK, FAK-L, FALK, FALK-L, FHLK, FHLK/M	265 kW		10/07→	for tropical climates; Ø 245 mm; 2 ports	8MV 376 757-261 Clutch, radiator fan	500
18.360 FAS, FALS, FHLS, FHLS/M	265 kW		10/07→	Bore Ø [mm]: 1; Depth [mm]: 128; Ø 190 mm; Number of mounting bores: 6; 2 pol; elec.	8MV 376 758-481 Clutch, radiator fan	502
18.400 FAC, FHLC	294 kW		10/07→	Bore Ø [mm]: 152; Diameter 1 [mm]: 704; Diameter 2 [mm]: 127; Number of Fan Blades: 9; Number of mounting bores: 6	8MV 376 758-561 Fan Wheel, engine cooling	507
18.400 FAK, FAK-L, FALK, FALK-L, FHLK, FHLK/M	294 kW		10/07→	Bore Ø [mm]: 200; Diameter 1 [mm]: 750; Diameter 2 [mm]: 180; Number of Fan Blades: 9	8MV 376 758-571 Fan Wheel, engine cooling	508
18.400 FAS, FALS, FHLS, FHLS/M	294 kW		10/07→			
24.320 FNLLW/N	235 kW		10/07→			
24.360 FNLLW/N	265 kW		10/07→			
24.360 FPLS, FPLRS	265 kW		10/07→			
24.400 FNLLW/N	294 kW		10/07→			
24.400 FPLS, FPLRS	294 kW		10/07→			
24.440 FNLLW/N	324 kW		10/07→			
24.440 FPLS, FPLRS	324 kW		10/07→			
26.320 FDC, FDRC, FDLC, FDLC/M, FDLRC, FDLRC/M, FNHLC	235 kW		07/08→			
26.320 FDK, FDLK	235 kW		07/08→			
26.320 FDS, FDLS, FDLS/M, FDRS, FDLRS, FDLRS/M, FNHLS	235 kW		07/08→			
26.320 FD-TM	235 kW		07/08→			
26.320 FNLC, FNLRC, FNLLC, FNLLRC, FNLLW, FVLC, FVL-KO	235 kW		10/07→			
26.320 FNLS, FNLRS, FNLLS, FPLS, FVLS	235 kW		07/08→			
26.360 FDC, FDRC, FDRC/M, FDLC, FDLRC, FNHLC	265 kW		08/08→			
26.360 FDK, FDLK, FDRK	265 kW		08/08→			
26.360 FDS, FDRS, FDRS/M, FDLS, FDLRS, FNHLS	265 kW		08/08→			
26.360 FD-TM	265 kW		07/08→			
26.360 FNLC, FNLRC, FNLLC, FNLLRC, FVLC, FVL-KO	265 kW		10/07→			
26.360 FNLLW	265 kW		04/08→			
26.360 FNLS, FNLLS, FNLRS, FPLS, FPLRS, FVLS	265 kW		08/08→			
26.360 FVHLC	265 kW		10/07→			
26.400 FDC, FDRC, FDC/M, FDLC, FDLC/M, FDLRC, FDLRC/M, FNHLC	294 kW		08/08→			
26.400 FDK, FDLK	294 kW		02/09→			
26.400 FDS, FDS/M, FDLS, FDLS/M, FDRS, FDLRS, FNHLS	294 kW		02/09→			
26.400 FD-TM	294 kW		07/08→			
26.400 FNLC, FNLRC, FNLLC, FNLLRC, FVLC, FVL-KO, FNLLW	294 kW		10/07→			
26.400 FNLS, FNLRS, FNLLS, FNLLRS, FPLS, FPLRS, FVLS	294 kW		02/09→			
26.400 FVHLC	294 kW		10/07→			
26.440 FDC, FDRC, FDC/M, FDLC, FDLC/M, FDLRC, FNHLC	324 kW		02/09→			
26.440 FDK, FDLK	324 kW		07/08→			
26.440 FDS, FDRS, FDS/M, FDLS, FDLRS, FNHLS	324 kW		02/09→			
26.440 FD-TM	324 kW		07/08→			

Manufacturer - Model	Power	Displ.	Year of Constr.	Remark	Part Number	Page
MAN - TGS						09/07→
26.440 FNLC, FNLLC, FNLLW, FNLR, FNLLRC, FVLC, FVL-KO	324 kW		10/07→	Depth [mm]: 42; L 938 mm; Vers. produced by BEHR; W 765 mm	8MK 376 721-711 Radiator, engine cooling	511
26.440 FNLS, FNLLS, FNLR, FPLS, FPLRS, FVLS	324 kW		02/09→	Depth [mm]: 42; L 845 mm; Vers. produced by BEHR; W 938 mm	8MK 376 728-661 Radiator, engine cooling	513
28.320 FNHLC	235 kW		07/08→	Depth [mm]: 52; L 938 mm; Vers. produced by BEHR; W 844 mm	8MK 376 756-011 Radiator, engine cooling	518
28.320 FNLC	235 kW		07/08→			
28.320 FNLS	235 kW		07/08→			
28.360 FANLC, FNHLC	265 kW		08/08→	Ø 270 mm; 5 ports	8MV 376 757-231 Clutch, radiator fan	500
28.360 FANLK	265 kW		08/08→	for tropical climates; Ø 245 mm; 2 ports	8MV 376 757-261 Clutch, radiator fan	500
28.360 FNLC	265 kW		08/08→			
28.360 FNLS	265 kW		08/08→			
28.400 FANLC, FNHLC	294 kW		08/08→	Bore Ø [mm]: 1; Depth [mm]: 128; Ø 190 mm; Number of mounting bores: 6; 2 pol; elec.	8MV 376 758-481 Clutch, radiator fan	502
28.400 FANLK	294 kW		08/08→			
28.400 FNLC	294 kW		08/08→	Bore Ø [mm]: 152; Diameter 1 [mm]: 704; Diameter 2 [mm]: 127; Number of Fan Blades: 9; Number of mounting bores: 6	8MK 376 756-011 Fan Wheel, engine cooling	507
28.400 FNLS	294 kW		08/08→			
28.440 FANLC, FNHLC	324 kW		08/08→	Bore Ø [mm]: 200; Diameter 1 [mm]: 750; Diameter 2 [mm]: 180; Number of Fan Blades: 9	8MV 376 758-571 Fan Wheel, engine cooling	508
28.440 FANLK	324 kW		08/08→			
28.440 FNLC	324 kW		08/08→			
28.440 FNLS	324 kW		08/08→			
32.320 FFD-TM	235 kW		02/09→			
32.360 FFDRC	265 kW		08/08→			
32.360 FFD-TM, FFDR-TM	265 kW		10/07→			
32.400 FFDRC	294 kW		08/08→			
32.400 FFD-TM, FFDR-TM	294 kW		10/07→			
32.440 FFDRC	324 kW		08/08→			
32.440 FFD-TM, FFDR-TM	324 kW		10/07→			
33.360 FDAC, FDALC	265 kW		06/08→			
33.360 FDAK, FDALK, FDHK	265 kW		10/07→			
33.360 FDAS, FDALS, FDHS	265 kW		10/07→			
33.360 FDC, FDLC	265 kW		06/08→			
33.360 FDK, FDLK	265 kW		02/09→			
33.360 FDS, FDLS	265 kW		06/08→			
33.400 FDAC, FDALC	294 kW		07/08→			
33.400 FDAK, FDALK, FDHK	294 kW		07/08→			
33.400 FDAS, FDALS, FDHS	294 kW		07/08→			
33.400 FDC, FDLC	294 kW		06/08→			
33.400 FDK, FDLK	294 kW		07/08→			
33.400 FDS, FDLS	294 kW		07/08→			
33.440 FDAC, FDALC	324 kW		07/08→			
33.440 FDAK, FDALK, FDHK	324 kW		11/07→			
33.440 FDAS, FDALS, FDHS	324 kW		10/07→			
33.440 FDC, FDLC	324 kW		06/08→			
33.440 FDK, FDLK	324 kW		06/08→			
33.440 FDS, FDLS, FDLS/M	324 kW		06/08→			
35.320 FFDAK, FFDHLK	235 kW		06/08→			
35.320 FFDC, FFDLC, FDNLC	235 kW		06/08→			
35.320 FFDK, FFDLK	235 kW		08/08→			
35.320 FFD-TM	235 kW		10/07→			
35.320 FFNLC	235 kW		01/09→			
35.360 FFDAK, FFHDLK	265 kW		06/08→			
35.360 FFDC, FFDLC, FDNLC	265 kW		06/08→			
35.360 FFDK, FFDLK, FFDRK	265 kW		08/08→			
35.360 FFD-TM	265 kW		10/07→			
35.360 FFNLC	265 kW		06/08→			
35.400 FFDC, FFDLC, FDNLC	294 kW		06/08→			
35.400 FFDK, FFDLK, FFDRK	294 kW		08/08→			
35.400 FFD-TM	294 kW		10/07→			
35.400 FFNHLC	294 kW		10/07→			
35.400 FFNLC	294 kW		06/08→			
35.440 FFDAK, FFDHLK	324 kW		06/08→			
35.440 FFDK, FFDLK, FFDRK	324 kW		08/08→			
35.440 FFD-TM	324 kW		10/07→			
35.440 FFNHLC	324 kW		10/07→			
35.440 FFNLC	324 kW		06/08→			
37.320 FFDC	235 kW		07/08→			
37.320 FFDK	235 kW		07/08→			
37.320 FFD-TM	235 kW		10/07→			
37.360 FFDC	265 kW		07/08→			
37.360 FFDK	265 kW		07/08→			
37.360 FFD-TM	265 kW		10/07→			
37.400 FFDC	294 kW		07/08→			
37.400 FFDK	294 kW		07/08→			
37.400 FFD-TM	294 kW		10/07→			
37.440 FFDC	324 kW		07/08→			
37.440 FFDK	324 kW		07/08→			
37.440 FFD-TM	324 kW		10/07→			
41.360 FFDC	265 kW		07/08→			
41.360 FFDK	265 kW		07/08→			
41.360 FFD-TM	265 kW		10/07→			
41.400 FFDC	294 kW		07/08→			
41.400 FFDK	294 kW		07/08→			

Manufacturer - Model	Power	Displ.	Year of Constr.	Remark	Part Number	Page
MAN - TGS						09/07→
41.400 FFD-TM	294 kW		10/07→	Depth [mm]: 42; L 938 mm; Vers. produced by BEHR; W 765 mm Depth [mm]: 42; L 845 mm; Vers. produced by BEHR; W 938 mm Depth [mm]: 52; L 938 mm; Vers. produced by BEHR; W 844 mm Ø 270 mm; 5 ports for tropical climates; Ø 245 mm; 2 ports Bore Ø [mm]: 1; Depth [mm]: 128; Ø 190 mm; Number of mounting bores: 6; 2 pol; elec. Bore Ø [mm]: 152; Diameter 1 [mm]: 704; Diameter 2 [mm]: 127; Number of Fan Blades: 9; Number of mounting bores: 6 Bore Ø [mm]: 200; Diameter 1 [mm]: 750; Diameter 2 [mm]: 180; Number of Fan Blades: 9	8MK 376 721-711	511
41.440 FFDC	324 kW		07/08→		Radiator, engine cooling	
41.440 FFDK	324 kW		07/08→		8MK 376 728-661	513
41.440 FFD-TM	324 kW		10/07→		Radiator, engine cooling	
					8MK 376 756-011	518
					Radiator, engine cooling	
					8MV 376 757-231	500
					Clutch, radiator fan	
				8MV 376 757-261	500	
				Clutch, radiator fan		
				8MV 376 758-481	502	
				Clutch, radiator fan		
				8MV 376 758-561 Fan	507	
				Wheel, engine cooling		
				8MV 376 758-571 Fan	508	
				Wheel, engine cooling		
18.320 FC, FLC, FLRC, FLLC, FLLRC, FLLW, FLLW/N	235 kW		10/07→	Depth [mm]: 42; L 920 mm; Vers. produced by BEHR; W 938 mm Depth [mm]: 42; L 938 mm; Vers. produced by BEHR; W 765 mm Depth [mm]: 42; L 845 mm; Vers. produced by BEHR; W 938 mm Depth [mm]: 52; L 938 mm; Vers. produced by BEHR; W 844 mm Depth [mm]: 52; L 938 mm; Vers. produced by BEHR; W 919 mm Ø 270 mm; 5 ports for tropical climates; Ø 245 mm; 2 ports Bore Ø [mm]: 1; Depth [mm]: 128; Ø 190 mm; Number of mounting bores: 6; 2 pol; elec. Bore Ø [mm]: 152; Diameter 1 [mm]: 704; Diameter 2 [mm]: 127; Number of Fan Blades: 9; Number of mounting bores: 6 Bore Ø [mm]: 200; Diameter 1 [mm]: 750; Diameter 2 [mm]: 180; Number of Fan Blades: 9	8MK 376 721-681	510
18.320 FK, FK-L, FLK, FLK/M	235 kW		10/07→		Radiator, engine cooling	
18.320 FLS, FLS/M, FLS-TS, FLRS, FLRS/M, FLLS, FLLS/N, FLLRS	235 kW		10/07→		8MK 376 721-711	511
					Radiator, engine cooling	
18.360 FC, FLC, FLRC, FLLC, FLLRC, FLLW, FLLW/N	265 kW		10/07→		8MK 376 728-661	513
18.360 FK, FK-L, FLK, FLK/M	265 kW		10/07→		Radiator, engine cooling	
18.360 FLS, FLS/M, FLS-TS, FLRS, FLRS/M, FLLS, FLLS/N, FLLRS	265 kW		10/07→		8MK 376 756-011	518
					Radiator, engine cooling	
18.400 FC, FLC, FLRC, FLLC, FLLRC, FLLW, FLLW/N	294 kW		10/07→	Ø 270 mm; 5 ports for tropical climates; Ø 245 mm; 2 ports Bore Ø [mm]: 1; Depth [mm]: 128; Ø 190 mm; Number of mounting bores: 6; 2 pol; elec. Bore Ø [mm]: 152; Diameter 1 [mm]: 704; Diameter 2 [mm]: 127; Number of Fan Blades: 9; Number of mounting bores: 6 Bore Ø [mm]: 200; Diameter 1 [mm]: 750; Diameter 2 [mm]: 180; Number of Fan Blades: 9	8MV 376 757-231	500
18.400 FK, FK-L, FLK, FLK/M	294 kW		10/07→		Clutch, radiator fan	
18.400 FLS, FLS/M, FLS-TS, FLRS, FLRS/M, FLLS, FLLS/N, FLLRS	294 kW		10/07→		8MV 376 757-261	500
					Clutch, radiator fan	
18.440 FC, FLC, FLRC, FLLC, FLLRC, FLLW, FLLW/N	324 kW		10/07→		8MV 376 758-481	502
18.440 FK, FK-L, FLK, FLK/M	324 kW		10/07→		Clutch, radiator fan	
18.440 FLS, FLS/M, FLS-TS, FLRS, FLRS/M, FLLS, FLLS/N, FLLRS	324 kW		10/07→		8MV 376 758-561 Fan	507
					Wheel, engine cooling	
18.480 FAC, FHLC	353 kW		10/07→	Depth [mm]: 42; L 938 mm; Vers. produced by BEHR; W 765 mm Depth [mm]: 42; L 845 mm; Vers. produced by BEHR; W 938 mm Depth [mm]: 52; L 938 mm; Vers. produced by BEHR; W 844 mm Ø 270 mm; 5 ports for tropical climates; Ø 245 mm; 2 ports Bore Ø [mm]: 152; Diameter 1 [mm]: 704; Diameter 2 [mm]: 127; Number of Fan Blades: 9; Number of mounting bores: 6 Bore Ø [mm]: 200; Diameter 1 [mm]: 750; Diameter 2 [mm]: 180; Number of Fan Blades: 9	8MK 376 721-711	511
18.480 FAK, FAK-L, FALK, FALK-L, FHLK, FHLK/M	353 kW		10/07→		Radiator, engine cooling	
18.480 FAS, FALS, FHLS	353 kW		10/07→		8MK 376 728-661	513
18.540 FAC, FHLC	397 kW		10/07→		Radiator, engine cooling	
18.540 FAK, FAK-L, FALK, FALK-L, FHLK, FHLK/M	397 kW		10/07→		8MK 376 756-011	518
18.540 FAS, FALS, FHLS, FHLS/M	397 kW		10/07→		Radiator, engine cooling	
24.480 FPLS, FPLRS	353 kW		10/07→		8MV 376 757-231	500
24.540 FPLS, FPLRS	397 kW		10/07→		Clutch, radiator fan	
26.480 FDC, FDC/M, FDLC, FDLC/M, FDRC, FDRC/M, FDLRC, FNLHC	353 kW		02/09→	Bore Ø [mm]: 152; Diameter 1 [mm]: 704; Diameter 2 [mm]: 127; Number of Fan Blades: 9; Number of mounting bores: 6 Bore Ø [mm]: 200; Diameter 1 [mm]: 750; Diameter 2 [mm]: 180; Number of Fan Blades: 9	8MV 376 758-561 Fan	507
26.480 FDK, FDLK	353 kW		07/08→		Wheel, engine cooling	
26.480 FDS, FDS/M, FDLS, FDLS/M, FDRS, FDLRS, FDRS/M, FNHLS	353 kW		02/09→		8MV 376 758-571 Fan	508
26.480 FNLC, FNLRC, FNLLC, FNLLRC, FNLLW, FVLC, FVLC-KO	353 kW		10/07→		Wheel, engine cooling	
26.480 FNLS, FNLLS, FNLRS, FPLS, FPLRS, FVLS	353 kW		02/09→			
26.540 FDC, FDC/M, FDLC, FDLC/M, FDLRC, FDLRC/M, FNHLC	397 kW		02/09→			
26.540 FDK, FDLK	397 kW		02/09→			
26.540 FDS, FDS/M, FDLS, FDRS, FDLRS, FDLRS/M, FNHLS	397 kW		02/09→			
26.540 FNLC, FNLRC, FNLLC, FNLLRC, FNLLW, FVLC, FVLC-KO	397 kW		10/07→			
26.540 FNLS, FNLLS, FPLS, FPLRS, FVLS	397 kW		02/09→			
28.480 FANLC, FNHLC	353 kW		08/08→			
28.480 FANLK	353 kW		08/08→			
28.480 FNLC	353 kW		08/08→			
28.480 FNLS	353 kW		08/08→			

Manufacturer - Model	Power	Displ.	Year of Constr.	Remark	Part Number	Page
MAN - TGS						09/07→
28.540 FNHLC	397 kW		06/08→	Depth [mm]: 42; L 938 mm; Vers. produced by BEHR; W 765 mm	8MK 376 721-711 Radiator, engine cooling	511
28.540 FNLC	397 kW		02/09→			
28.540 FNLS	397 kW		02/09→	Depth [mm]: 42; L 845 mm; Vers. produced by BEHR; W 938 mm	8MK 376 728-661 Radiator, engine cooling	513
32.480 FFD-TM	353 kW		08/08→			
33.480 FDAC, FDALC	353 kW		08/08→	Depth [mm]: 52; L 938 mm; Vers. produced by BEHR; W 844 mm	8MK 376 756-011 Radiator, engine cooling	518
33.480 FDAK, FDALK	353 kW		08/08→			
33.480 FDAS, FDALS, FDHS	353 kW		10/07→	Ø 270 mm; 5 ports	8MV 376 757-231 Clutch, radiator fan	500
33.480 FDC, FDC/M, FDLC, FDLC/M	353 kW		08/08→			
33.480 FDK, FDLK	353 kW		08/08→	for tropical climates; Ø 245 mm; 2 ports	8MV 376 757-261 Clutch, radiator fan	500
33.480 FDS, FDLs, FDLs/M	353 kW		08/08→			
33.540 FDAC, FDALC	397 kW		02/09→	Bore Ø [mm]: 152; Diameter 1 [mm]: 704; Diameter 2 [mm]: 127; Number of Fan Blades: 9; Number of mounting bores: 6	8MV 376 758-561 Fan	507
33.540 FDAK, FDALK	397 kW		02/09→			
33.540 FDAS, FDALS	397 kW		02/09→	Bore Ø [mm]: 200; Diameter 1 [mm]: 750; Diameter 2 [mm]: 180; Number of Fan Blades: 9	8MV 376 758-571 Fan	508
33.540 FDC, FDLC, FDLC/M	397 kW		02/09→			
33.540 FDK, FDLK	397 kW		02/09→			
33.540 FDS, FDLs, FDLs/M	397 kW		02/09→			
35.480 FDNLC, FFDC, FFDLC	353 kW		06/08→			
35.480 FDDAK, FDDHLK	353 kW		06/08→			
35.480 FFDK, FFDLK, FFDK	353 kW		08/08→			
35.480 FFD-TM	353 kW		10/07→			
35.480 FFNHLC	353 kW		10/07→			
35.480 FFNLC	353 kW		06/08→			
35.540 FDNLC, FFDC, FFDLC	397 kW		06/08→			
35.540 FDDAK, FDDHLK	397 kW		02/09→			
35.540 FFDK, FFDLK, FFDK	397 kW		02/09→			
35.540 FFD-TM	397 kW		10/07→			
35.540 FFNLC	397 kW		02/09→			
37.480 FFDC	353 kW		07/08→			
37.480 FFDK	353 kW		07/08→			
37.480 FFD-TM	353 kW		10/07→			
37.540 FFDC	397 kW		02/09→			
37.540 FFDK	397 kW		02/09→			
37.540 FFD-TM	397 kW		10/07→			
41.480 FFDC	353 kW		07/08→			
41.480 FFDK	353 kW		07/08→			
41.480 FFD-TM	353 kW		10/07→			
41.540 FFDC	397 kW		02/09→			
41.540 FFDK	397 kW		02/09→			
41.540 FFD-TM	397 kW		10/07→			
18.480 FC, FLC, FLRC, FLLC, FLLRC, FLLW, FLLW/N	353 kW		10/07→	Depth [mm]: 42; L 920 mm; Vers. produced by BEHR; W 938 mm	8MK 376 721-681 Radiator, engine cooling	510
18.480 FK, FK-L, FLK, FLK/M	353 kW		10/07→			
18.480 FLS, FLS/M, FLS-TS, FLRS, FLRS/M, FLLS, FLLS/N, FLLRS	353 kW		10/07→	Depth [mm]: 42; L 845 mm; Vers. produced by BEHR; W 938 mm	8MK 376 728-661 Radiator, engine cooling	513
18.540 FC, FLC, FLRC, FLLC, FLLRC, FLLW, FLLW/N	397 kW		10/07→			
18.540 FK, FK-L, FLK, FLK/M	397 kW		10/07→	Depth [mm]: 52; L 938 mm; Vers. produced by BEHR; W 844 mm	8MK 376 756-011 Radiator, engine cooling	518
18.540 FLS, FLS/M, FLRS, FLRS/M, FLLS, FLLS/N, FLLRS	397 kW		10/07→			
				Ø 270 mm; 5 ports	8MV 376 757-231 Clutch, radiator fan	500
				for tropical climates; Ø 245 mm; 2 ports	8MV 376 757-261 Clutch, radiator fan	500
				Bore Ø [mm]: 152; Diameter 1 [mm]: 704; Diameter 2 [mm]: 127; Number of Fan Blades: 9; Number of mounting bores: 6	8MV 376 758-561 Fan	507
				Bore Ø [mm]: 200; Diameter 1 [mm]: 750; Diameter 2 [mm]: 180; Number of Fan Blades: 9	8MV 376 758-571 Fan	508
19.360 FS/M-WW, FLS/M-WW, FRS/M-WW, FLRS/M-WW	265 kW		02/11→	Ø 270 mm; 5 ports	8MV 376 757-231 Clutch, radiator fan	500
19.400 FS/M-WW, FLS/M-WW, FRS/M-WW, FLRS/M-WW	294 kW		02/11→			
19.440 FS-WW, FRS-WW, FLS-WW, FLRS-WW	324 kW		02/11→	for tropical climates; Ø 245 mm; 2 ports	8MV 376 757-261 Clutch, radiator fan	500
19.480 FS/M-WW, FRS/M-WW, FLS/M-WW, FLRS/M-WW	353 kW		02/11→			
40.400 FDAK-WW, FDARK-WW	294 kW		02/11→			
40.400 FDAS-WW, FDARS-WW	294 kW		02/11→			
40.440 FDAK-WW, FDARK-WW	324 kW		02/11→			
40.440 FDAS-WW, FDARS-WW	324 kW		02/11→			
26.320 FDAC, FDALC, FDHLC, FDHLC/M	235 kW		07/08→	Depth [mm]: 42; L 920 mm; Vers. produced by BEHR; W 938 mm	8MK 376 721-681 Radiator, engine cooling	510
26.320 FDAK, FDALK, FDHK, FDHLK	235 kW		07/08→			
26.320 FDAS, FDALS, FDHS, FDHLS, FDHLS/M	235 kW		07/08→	Depth [mm]: 42; L 845 mm; Vers. produced by BEHR; W 938 mm	8MK 376 728-661 Radiator, engine cooling	513
26.320 FVHLC	235 kW		10/07→			
				Depth [mm]: 52; L 938 mm; Vers. produced by BEHR; W 844 mm	8MK 376 756-011 Radiator, engine cooling	518

Manufacturer - Model	Power	Displ.	Year of Constr.	Remark	Part Number	Page
MAN - TGS						09/07→
26.360 FDAC, FDALC, FDHLC, FDHLC/M	265 kW		08/08→	Ø 270 mm; 5 ports	8MV 376 757-231 Clutch, radiator fan	500
26.360 FDAK, FDALK, FDHK, FDHLK	265 kW		08/08→	for tropical climates; Ø 245 mm; 2 ports	8MV 376 757-261 Clutch, radiator fan	500
26.360 FDAS, FDALS, FDHS, FDHLS, FDHLS/M	265 kW		08/08→	Bore Ø [mm]: 1; Depth [mm]: 128; Ø 190 mm; Number of mounting bores: 6; 2 pol; elec.	8MV 376 758-481 Clutch, radiator fan	502
26.360 FPHLS	265 kW		05/08→			
26.360 FVHLS	265 kW		05/08→	Bore Ø [mm]: 152; Diameter 1 [mm]: 704; Diameter 2 [mm]: 127; Number of Fan Blades: 9; Number of mounting bores: 6	8MV 376 758-561 Fan	507
26.400 FDAC, FDALC, FDHLC, FDHLC/M	294 kW		02/09→		Wheel, engine cooling	
26.400 FDAK, FDALK, FDHK, FDHLK	294 kW		11/07→	Bore Ø [mm]: 200; Diameter 1 [mm]: 750; Diameter 2 [mm]: 180; Number of Fan Blades: 9	8MV 376 758-571 Fan	508
26.400 FDAS, FDALS, FDHS, FDHLS, FDHLS/M	294 kW		09/07→		Wheel, engine cooling	
26.400 FPHLS	294 kW		05/08→			
26.400 FVHLS	294 kW		05/08→			
26.440 FDAC, FDALC, FDHLC, FDHLC/M	324 kW		02/09→			
26.440 FDAK, FDALK, FDHK, FDHLK	324 kW		11/07→			
26.440 FDAS, FDALS, FDHLS, FDHLS/M	324 kW		02/09→			
26.440 FPHLS	324 kW		05/08→			
26.440 FVHLC	324 kW		10/07→			
26.440 FVHLS	324 kW		05/08→			
35.320 FFDAK	235 kW		06/08→			
35.360 FFDAK	265 kW		06/08→			
35.400 FFDAK	294 kW		06/08→			
35.400 FFDAK, FFDHLK	294 kW		06/08→			
35.440 FDNLC, FFDC, FFDLC, FFNLC	324 kW		06/08→			
35.440 FFDAK	324 kW		06/08→			
41.320 FFDAK	235 kW		06/08→			
41.360 FFDAK	265 kW		06/08→			
41.440 FFDAK	324 kW		06/08→			
26.480 FDAC, FDALC, FDHLC, FDHLC/M	353 kW		02/09→	Depth [mm]: 42; L 920 mm; Vers. produced by BEHR; W 938 mm	8MK 376 721-681 Radiator, engine cooling	510
26.480 FDAK, FDALK, FDHK, FDHLK	353 kW		02/09→	Depth [mm]: 42; L 938 mm; Vers. produced by BEHR; W 765 mm	8MK 376 721-711 Radiator, engine cooling	511
26.480 FDAS, FDALS, FDHS, FDHLS	353 kW		02/09→	Depth [mm]: 42; L 845 mm; Vers. produced by BEHR; W 938 mm	8MK 376 728-661 Radiator, engine cooling	513
26.480 FPHLS	353 kW		05/08→	Depth [mm]: 52; L 938 mm; Vers. produced by BEHR; W 844 mm	8MK 376 756-011 Radiator, engine cooling	518
26.480 FVHLC	353 kW		10/07→			
26.480 FVHLS	353 kW		05/08→			
26.540 FDAC, FDALC, FDHLC, FDHLC/M	397 kW		02/09→	Ø 270 mm; 5 ports	8MV 376 757-231 Clutch, radiator fan	500
26.540 FDAK, FDALK, FDHLK	397 kW		11/07→	for tropical climates; Ø 245 mm; 2 ports	8MV 376 757-261 Clutch, radiator fan	500
26.540 FDAS, FDALS, FDHLS	397 kW		02/09→			
35.480 FFDAK	353 kW		06/08→	Bore Ø [mm]: 152; Diameter 1 [mm]: 704; Diameter 2 [mm]: 127; Number of Fan Blades: 9; Number of mounting bores: 6	8MV 376 758-561 Fan	507
35.540 FFDAK	397 kW		02/09→		Wheel, engine cooling	
41.480 FFDAK	353 kW		06/08→			
41.480 FFDARC	353 kW		06/08→	Bore Ø [mm]: 200; Diameter 1 [mm]: 750; Diameter 2 [mm]: 180; Number of Fan Blades: 9	8MV 376 758-571 Fan	508
41.540 FFDAK	397 kW		02/09→		Wheel, engine cooling	
MAN - TGX						09/07→
18.360 FHLC	265 kW		10/07→	Depth [mm]: 42; L 920 mm; Vers. produced by BEHR; W 938 mm	8MK 376 721-681 Radiator, engine cooling	510
18.360 FHLS, FHLS/M	265 kW		10/07→			
18.400 FHLC	294 kW		10/07→	Depth [mm]: 52; L 938 mm; Vers. produced by BEHR; W 919 mm	8MK 376 756-021 Radiator, engine cooling	518
18.400 FHLS, FHLS/M	294 kW		10/07→			
18.440 FHLC	324 kW		10/07→	Ø 270 mm; 5 ports	8MV 376 757-231 Clutch, radiator fan	500
18.440 FHLS, FHLS/M	324 kW		10/07→			
24.360 FNLLW/N	265 kW		10/07→	for tropical climates; Ø 245 mm; 2 ports	8MV 376 757-261 Clutch, radiator fan	500
24.360 FPLS, FPLRS	265 kW		10/07→			
24.400 FNLLW/N	294 kW		10/07→	Bore Ø [mm]: 1; Depth [mm]: 128; Ø 190 mm; Number of mounting bores: 6; 2 pol; elec.	8MV 376 758-481 Clutch, radiator fan	502
24.400 FPLS, FPLRS	294 kW		10/07→			
24.440 FNLLW/N	324 kW		10/07→			
24.440 FPLS, FPLRS	324 kW		10/07→	Bore Ø [mm]: 152; Diameter 1 [mm]: 704; Diameter 2 [mm]: 127; Number of Fan Blades: 9; Number of mounting bores: 6	8MV 376 758-561 Fan	507
26.320 FNLS, FNLLS	235 kW		10/07→		Wheel, engine cooling	
26.360 FNLC, FNLR, FNLLC, FNLLRC, FNLLW	265 kW		10/07→	Bore Ø [mm]: 200; Diameter 1 [mm]: 750; Diameter 2 [mm]: 180; Number of Fan Blades: 9	8MV 376 758-571 Fan	508
26.360 FNLS, FNLLS, FNLR, FNLLRS, FPLS, FPLRS, FVLS	265 kW		10/07→		Wheel, engine cooling	
26.360 FVHLS	265 kW		05/08→			
26.400 FNLC, FNLR, FNLLC, FNLLRC, FNLLW	294 kW		10/07→			
26.400 FNLS, FNLLS, FNLR, FNLLRS, FPLS, FPLRS, FVLS	294 kW		10/07→			
26.400 FPHLS	294 kW		05/08→			
26.400 FVHLS	294 kW		05/08→			

Manufacturer - Model	Power	Displ.	Year of Constr.	Remark	Part Number	Page
MAN - TGX						09/07→
26.440 FNLC, FNLRC, FNLLC, FNLLRC, FNLLW	324 kW		10/07→	Depth [mm]: 42; L 920 mm; Vers. produced by BEHR; W 938 mm	8MK 376 721-681 Radiator, engine cooling	510
26.440 FNLS, FNLLS, FNLRs, FNLLRS, FPLS, FPLRS, FVLS	324 kW		10/07→	Depth [mm]: 52; L 938 mm; Vers. produced by BEHR; W 919 mm	8MK 376 756-021 Radiator, engine cooling	518
26.440 FPHLS	324 kW		05/08→	Ø 270 mm; 5 ports	8MV 376 757-231 Clutch, radiator fan	500
26.440 FVHLS	324 kW		05/08→		8MV 376 757-261 Clutch, radiator fan	500
28.360 FNLC	265 kW		10/07→	for tropical climates; Ø 245 mm; 2 ports	8MV 376 757-261 Clutch, radiator fan	500
28.360 FNLS	265 kW		10/07→		8MV 376 758-481 Clutch, radiator fan	502
28.400 FNLC	294 kW		10/07→	Bore Ø [mm]: 1; Depth [mm]: 128; Ø 190 mm; Number of mounting bores: 6; 2 pol; elec.	8MV 376 758-561 Fan	507
28.400 FNLS	294 kW		10/07→		8MV 376 758-571 Fan	508
28.440 FNLC	324 kW		10/07→	Bore Ø [mm]: 152; Diameter 1 [mm]: 704; Diameter 2 [mm]: 127; Number of Fan Blades: 9; Number of mounting bores: 6	8MV 376 758-561 Fan	507
28.440 FNLS	324 kW		10/07→		8MV 376 758-571 Fan	508
35.360 FDNLC	265 kW		06/08→	Bore Ø [mm]: 200; Diameter 1 [mm]: 750; Diameter 2 [mm]: 180; Number of Fan Blades: 9	8MV 376 758-561 Fan	507
35.400 FDNLC	294 kW		06/08→		8MV 376 758-571 Fan	508
35.440 FDNLC	324 kW		06/08→	Bore Ø [mm]: 200; Diameter 1 [mm]: 750; Diameter 2 [mm]: 180; Number of Fan Blades: 9	8MV 376 758-561 Fan	507
					8MV 376 758-571 Fan	508
18.360 FLC, FLRC, FLLC, FLLRC, FLLW, FLLW/N	265 kW		10/07→	Depth [mm]: 42; L 920 mm; Vers. produced by BEHR; W 938 mm	8MK 376 721-681 Radiator, engine cooling	510
18.360 FLS, FLS/M, FLRS, FLRS/N, FLS, FLLS/N, FLLRS, FLLRS/N	265 kW		10/07→	Depth [mm]: 42; L 938 mm; Vers. produced by BEHR; W 765 mm	8MK 376 721-711 Radiator, engine cooling	511
18.400 FLC, FLRC, FLLC, FLLRC, FLLW, FLLW/N	294 kW		10/07→	Depth [mm]: 42; L 845 mm; Vers. produced by BEHR; W 938 mm	8MK 376 728-661 Radiator, engine cooling	513
18.400 FLS, FLS/M, FLRS, FLRS/N, FLS, FLLS/N, FLLRS, FLLRS/N	294 kW		10/07→	Depth [mm]: 52; L 938 mm; Vers. produced by BEHR; W 844 mm	8MK 376 756-011 Radiator, engine cooling	518
18.440 FLC, FLRC, FLLC, FLLRC, FLLW, FLLW/N	324 kW		10/07→	Depth [mm]: 52; L 938 mm; Vers. produced by BEHR; W 919 mm	8MK 376 756-021 Radiator, engine cooling	518
18.440 FLS, FLS/M, FLRS, FLRS/M, FLS, FLLS/N, FLLRS, FLLRS/	324 kW		10/07→	Ø 270 mm; 5 ports	8MV 376 757-231 Clutch, radiator fan	500
				for tropical climates; Ø 245 mm; 2 ports	8MV 376 757-261 Clutch, radiator fan	500
				Bore Ø [mm]: 1; Depth [mm]: 128; Ø 190 mm; Number of mounting bores: 6; 2 pol; elec.	8MV 376 758-481 Clutch, radiator fan	502
				Bore Ø [mm]: 152; Diameter 1 [mm]: 704; Diameter 2 [mm]: 127; Number of Fan Blades: 9; Number of mounting bores: 6	8MV 376 758-561 Fan	507
				Bore Ø [mm]: 200; Diameter 1 [mm]: 750; Diameter 2 [mm]: 180; Number of Fan Blades: 9	8MV 376 758-571 Fan	508
18.440 FLRC	324 kW		10/07→	Depth [mm]: 42; L 920 mm; Vers. produced by BEHR; W 938 mm	8MK 376 721-681 Radiator, engine cooling	510
18.440 FLRS	324 kW		10/07→	Depth [mm]: 42; L 938 mm; Vers. produced by BEHR; W 765 mm	8MK 376 721-711 Radiator, engine cooling	511
18.480 FLC, FLRC, FLLC, FLLRC, FLLW, FLLW/N	353 kW		10/07→	Depth [mm]: 42; L 845 mm; Vers. produced by BEHR; W 938 mm	8MK 376 728-661 Radiator, engine cooling	513
18.480 FLS, FLS/M, FLRS, FLRS/N, FLS, FLLS/N, FLLRS, FLLRS/N	353 kW		10/07→	Depth [mm]: 52; L 938 mm; Vers. produced by BEHR; W 844 mm	8MK 376 756-011 Radiator, engine cooling	518
18.540 FLC, FLRC, FLLC, FLLRC, FLLW, FLLW/N	397 kW		10/07→	Depth [mm]: 52; L 938 mm; Vers. produced by BEHR; W 919 mm	8MK 376 756-021 Radiator, engine cooling	518
18.540 FLS, FLS/M, FLRS, FLRS/N, FLS, FLLS/ N, FLLRS, FLLRS/N	397 kW		10/07→	Ø 270 mm; 5 ports	8MV 376 757-231 Clutch, radiator fan	500
				for tropical climates; Ø 245 mm; 2 ports	8MV 376 757-261 Clutch, radiator fan	500
				Bore Ø [mm]: 152; Diameter 1 [mm]: 704; Diameter 2 [mm]: 127; Number of Fan Blades: 9; Number of mounting bores: 6	8MV 376 758-561 Fan	507
				Bore Ø [mm]: 200; Diameter 1 [mm]: 750; Diameter 2 [mm]: 180; Number of Fan Blades: 9	8MV 376 758-571 Fan	508
18.480 FHLC	353 kW		10/07→	Depth [mm]: 42; L 920 mm; Vers. produced by BEHR; W 938 mm	8MK 376 721-681 Radiator, engine cooling	510
18.480 FHLS, FHLS/M	353 kW		10/07→	Depth [mm]: 52; L 938 mm; Vers. produced by BEHR; W 919 mm	8MK 376 756-021 Radiator, engine cooling	518
18.540 FHLC	397 kW		10/07→	Ø 270 mm; 5 ports	8MV 376 757-231 Clutch, radiator fan	500
18.540 FHLS, FHLS/M	397 kW		10/07→		8MV 376 757-261 Clutch, radiator fan	500
24.440 FPLRS	324 kW		10/07→	for tropical climates; Ø 245 mm; 2 ports	8MV 376 757-261 Clutch, radiator fan	500
24.480 FNLLW/N	353 kW		10/07→		8MV 376 758-561 Fan	507
24.480 FPLS, FPLRS	353 kW		10/07→	Bore Ø [mm]: 152; Diameter 1 [mm]: 704; Diameter 2 [mm]: 127; Number of Fan Blades: 9; Number of mounting bores: 6	8MV 376 758-561 Fan	507
24.540 FNLLW/N	397 kW		02/09→		8MV 376 758-571 Fan	508
24.540 FPLS, FPLRS	397 kW		10/07→	Bore Ø [mm]: 200; Diameter 1 [mm]: 750; Diameter 2 [mm]: 180; Number of Fan Blades: 9	8MV 376 758-561 Fan	507
26.440 FPLRS	324 kW		07/08→		8MV 376 758-571 Fan	508
26.480 FNLC, FNLRC, FNLLC, FNLLRC, FNLLW	353 kW		10/07→	Bore Ø [mm]: 200; Diameter 1 [mm]: 750; Diameter 2 [mm]: 180; Number of Fan Blades: 9	8MV 376 758-561 Fan	507
26.480 FNLS, FNLLS, FNLRs, FNLLRS, FPLS, FPLRS, FVLS	353 kW		10/07→		8MV 376 758-571 Fan	508
26.480 FPHLS	353 kW		05/08→			
26.480 FVHLS	353 kW		05/08→			
26.540 FNLC, FNLRC, FNLLC, FNLLRC, FNLLW	397 kW		10/07→			
26.540 FNLS, FNLRs, FNLLS, FPLS, FPLRS, FVLS	397 kW		10/07→			
28.480 FNLC	353 kW		10/07→			
28.480 FNLS	353 kW		10/07→			

Manufacturer - Model	Power	Displ.	Year of Constr.	Remark	Part Number	Page	
MAN - TGX						09/07→	
28.540 FNLC	397 kW		10/07→	Depth [mm]: 42; L 920 mm; Vers. produced by BEHR; W 938 mm	8MK 376 721-681	510	
28.540 FNLS	397 kW		02/09→		Radiator, engine cooling		
35.480 FDNLC	353 kW		06/08→		Depth [mm]: 52; L 938 mm; Vers. produced by BEHR; W 919 mm	8MK 376 756-021	518
35.540 FDNLC	397 kW		06/08→			Radiator, engine cooling	
						Ø 270 mm; 5 ports	8MV 376 757-231
				for tropical climates; Ø 245 mm; 2 ports	8MV 376 757-261	500	
				Bore Ø [mm]: 152; Diameter 1 [mm]: 704; Diameter 2 [mm]: 127; Number of Fan Blades: 9; Number of mounting bores: 6	8MV 376 758-561 Fan	507	
				Bore Ø [mm]: 200; Diameter 1 [mm]: 750; Diameter 2 [mm]: 180; Number of Fan Blades: 9	8MV 376 758-571 Fan	508	
					Wheel, engine cooling		
18.680 FLS	500 kW		10/07→	Bore Ø [mm]: 152; Diameter 1 [mm]: 704; Diameter 2 [mm]: 127; Number of Fan Blades: 9; Number of mounting bores: 6	8MV 376 758-561 Fan	507	
33.680 FDLC	500 kW		10/07→		Wheel, engine cooling		
33.680 FDLS	500 kW		10/07→		Bore Ø [mm]: 200; Diameter 1 [mm]: 750; Diameter 2 [mm]: 180; Number of Fan Blades: 9	8MV 376 758-571 Fan	508
					Wheel, engine cooling		
26.360 FDC, FDLC, FDRC, FDLRC	265 kW		07/08→	Depth [mm]: 42; L 920 mm; Vers. produced by BEHR; W 938 mm	8MK 376 721-681	510	
26.360 FDS, FDLS, FDRS, FDLRS	265 kW		07/08→		Radiator, engine cooling		
26.400 FDC, FDLC, FDRC, FDLRC	294 kW		07/08→	Depth [mm]: 42; L 845 mm; Vers. produced by BEHR; W 938 mm	8MK 376 728-661	513	
26.400 FDS, FDLS, FDRS, FDLRS	294 kW		07/08→		Radiator, engine cooling		
26.400 FDC, FDLC, FDRC, FDLRC	294 kW		07/08→	Depth [mm]: 52; L 938 mm; Vers. produced by BEHR; W 919 mm	8MK 376 756-021	518	
26.400 FDS, FDLS, FDRS, FDLRS	294 kW		07/08→		Radiator, engine cooling		
26.440 FDC, FDLC, FDRC, FDLRC	324 kW		07/08→	Ø 270 mm; 5 ports	8MV 376 757-231	500	
26.440 FDS, FDLS, FDRS, FDLRS	324 kW		07/08→		Clutch, radiator fan		
26.440 FDC, FDLC, FDRC, FDLRC	324 kW		07/08→	for tropical climates; Ø 245 mm; 2 ports	8MV 376 757-261	500	
26.440 FDS, FDLS, FDRS, FDLRS	324 kW		07/08→	Clutch, radiator fan			
33.360 FDC, FDC/M, FDLC	265 kW		10/07→	Bore Ø [mm]: 1; Depth [mm]: 128; Ø 190 mm; Number of mounting bores: 6; 2 pol; elec.	8MV 376 758-481	502	
33.360 FDS, FDS/M, FDLS, FDLS/M	265 kW		10/07→		Clutch, radiator fan		
33.400 FDC, FDC/M, FDLC	294 kW		10/07→	Bore Ø [mm]: 152; Diameter 1 [mm]: 704; Diameter 2 [mm]: 127; Number of Fan Blades: 9; Number of mounting bores: 6	8MV 376 758-561 Fan	507	
33.400 FDS, FDS/M, FDLS, FDLS/M	294 kW		10/07→		Wheel, engine cooling		
33.440 FDC, FDC/M, FDLC	324 kW		10/07→	Bore Ø [mm]: 200; Diameter 1 [mm]: 750; Diameter 2 [mm]: 180; Number of Fan Blades: 9	8MV 376 758-571 Fan	508	
33.440 FDS, FDS/M, FDLS, FDLS/M	324 kW		10/07→		Wheel, engine cooling		
26.360 FDHLC	265 kW		10/07→	Ø 270 mm; 5 ports	8MV 376 757-231	500	
26.360 FDHLS	265 kW		10/07→		Clutch, radiator fan		
26.360 FNHLC	265 kW		10/07→	for tropical climates; Ø 245 mm; 2 ports	8MV 376 757-261	500	
26.360 FNHLS	265 kW		12/07→		Clutch, radiator fan		
26.400 FDHLC	294 kW		10/07→	Bore Ø [mm]: 1; Depth [mm]: 128; Ø 190 mm; Number of mounting bores: 6; 2 pol; elec.	8MV 376 758-481	502	
26.400 FDHLS	294 kW		10/07→		Clutch, radiator fan		
26.400 FNHLC	294 kW		12/07→	Bore Ø [mm]: 152; Diameter 1 [mm]: 704; Diameter 2 [mm]: 127; Number of Fan Blades: 9; Number of mounting bores: 6	8MV 376 758-561 Fan	507	
26.400 FNHLS	294 kW		12/07→		Wheel, engine cooling		
26.440 FDHLC	324 kW		09/07→	Bore Ø [mm]: 200; Diameter 1 [mm]: 750; Diameter 2 [mm]: 180; Number of Fan Blades: 9	8MV 376 758-571 Fan	508	
26.440 FDHLS	324 kW		10/07→		Wheel, engine cooling		
26.440 FNHLC	324 kW		12/07→	Ø 270 mm; 5 ports	8MV 376 757-231	500	
26.440 FNHLS	324 kW		12/07→		Clutch, radiator fan		
26.480 FDC, FDLC, FDRC, FDLRC	353 kW		07/08→	Depth [mm]: 42; L 920 mm; Vers. produced by BEHR; W 938 mm	8MK 376 721-681	510	
26.480 FDS, FDLS, FDRS, FDLRS	353 kW		07/08→		Radiator, engine cooling		
26.540 FDC, FDLC, FDRC, FDLRC	397 kW		02/09→	Depth [mm]: 42; L 845 mm; Vers. produced by BEHR; W 938 mm	8MK 376 728-661	513	
26.540 FDS, FDLS, FDRS, FDLRS	397 kW		02/09→		Radiator, engine cooling		
33.480 FDC, FDC/M, FDLC	353 kW		10/07→	Depth [mm]: 52; L 938 mm; Vers. produced by BEHR; W 919 mm	8MK 376 756-021	518	
33.480 FDS, FDS/M, FDLS, FDLS/M	353 kW		10/07→		Radiator, engine cooling		
33.540 FDC, FDC/M, FDLC	397 kW		10/07→	Ø 270 mm; 5 ports	8MV 376 757-231	500	
33.540 FDS, FDS/M, FDLS, FDLS/M	397 kW		10/07→		Clutch, radiator fan		
				for tropical climates; Ø 245 mm; 2 ports	8MV 376 757-261	500	
				Bore Ø [mm]: 152; Diameter 1 [mm]: 704; Diameter 2 [mm]: 127; Number of Fan Blades: 9; Number of mounting bores: 6	8MV 376 758-561 Fan	507	
				Bore Ø [mm]: 200; Diameter 1 [mm]: 750; Diameter 2 [mm]: 180; Number of Fan Blades: 9	8MV 376 758-571 Fan	508	
					Wheel, engine cooling		
26.480 FDHLC	353 kW		09/07→	Ø 270 mm; 5 ports	8MV 376 757-231	500	
26.480 FDHLS	353 kW		10/07→		Clutch, radiator fan		
26.480 FNHLC	353 kW		12/07→	for tropical climates; Ø 245 mm; 2 ports	8MV 376 757-261	500	
26.480 FNHLS	353 kW		12/07→		Clutch, radiator fan		
				Bore Ø [mm]: 152; Diameter 1 [mm]: 704; Diameter 2 [mm]: 127; Number of Fan Blades: 9; Number of mounting bores: 6	8MV 376 758-561 Fan	507	
				Bore Ø [mm]: 200; Diameter 1 [mm]: 750; Diameter 2 [mm]: 180; Number of Fan Blades: 9	8MV 376 758-571 Fan	508	
					Wheel, engine cooling		
41.540 FVDS, FVDLS	397 kW		06/08→	Depth [mm]: 42; L 920 mm; Vers. produced by BEHR; W 938 mm	8MK 376 721-681	510	
					Radiator, engine cooling		

Manufacturer - Model	Power	Displ.	Year of Constr.	Remark	Part Number	Page
MAN - TGX						09/07→
41.540 FVDS, FVDLS	397 kW		06/08→	Depth [mm]: 52; L 938 mm; Vers. produced by BEHR; W 919 mm	8MK 376 756-021	518
				Ø 270 mm; 5 ports	8MV 376 757-231	500
				for tropical climates; Ø 245 mm; 2 ports	8MV 376 757-261	500
				Ø 753 mm; Number of Fan Blades: 9	8MV 376 757-271	505
				Bore Ø [mm]: 152; Diameter 1 [mm]: 704; Diameter 2 [mm]: 127; Number of Fan Blades: 9; Number of mounting bores: 6	8MV 376 758-561	507
				Bore Ø [mm]: 200; Diameter 1 [mm]: 750; Diameter 2 [mm]: 180; Number of Fan Blades: 9	8MV 376 758-571	508
41.680 FVDS, FVDLS	500 kW		10/07→	Depth [mm]: 42; L 920 mm; Vers. produced by BEHR; W 938 mm	8MK 376 721-681	510
				Ø 753 mm; Number of Fan Blades: 9	8MV 376 757-271	505
				Bore Ø [mm]: 152; Diameter 1 [mm]: 704; Diameter 2 [mm]: 127; Number of Fan Blades: 9; Number of mounting bores: 6	8MV 376 758-561	507
				Bore Ø [mm]: 200; Diameter 1 [mm]: 750; Diameter 2 [mm]: 180; Number of Fan Blades: 9	8MV 376 758-571	508
MAN - ÜL						04/92→
ÜL 272	198 kW		03/93→		8MK 376 774-501	519
ÜL 312, ÜL 322	228 - 235 kW		04/92→09/96		Radiator, engine cooling	
ÜL 313	228 kW		09/96→	+ OE 81061016487; Depth [mm]: 42; L 945 mm; Vers. produced by BEHR; W 708 mm	8MK 376 722-411	513
ÜL 353	257 kW		06/97→		8MK 376 774-501	519
					Radiator, engine cooling	

DAF	HELLA	MAN	HELLA
1399819	8MV 376 757-421	81.06102.6222	8MA 376 705-331
IVECO	HELLA	81.06102.6226	8MA 376 705-381
8604 052	8MV 376 728-131	81.06102.6227	8MA 376 705-331
LIEBHERR	HELLA	81.06601.0072	8MV 376 757-421
1 033 794 4	8MA 376 705-241	81.06630.6064	8MV 376 728-131
MAN	HELLA	8106101.6514	8MK 376 722-241
51.06601.0257	8MV 376 757-271	81 06101 6327	8MK 376 709-561
51.06601.0263	8MV 376 758-561	81 06101 6352	8MK 376 709-561
51.06601.0266	8MV 376 757-731	81 06101 6353	8MK 376 709-561
51.06601.0268	8MV 376 758-571	81 06101 6355	8MK 376 709-561
51.06601.0275	8MV 376 757-271	81 06101 6358	8MK 376 709-561
51.06601.0275	8MV 376 757-721	81 06101 6379	8MK 376 709-561
51.06630.0060	8MV 376 758-551	81 06101 6385	8MK 376 709-561
51.06630.0065	8MV 376 758-551	81 06101 6421	8MK 376 721-461
51.06630.0067	8MV 376 757-671	81 06101 6423	8MK 376 721-481
51.06630.0068	8MV 376 757-221	81 06101 6437	8MK 376 721-761
51.06630.0071	8MV 376 757-681	81 06101 6438	8MK 376 721-481
51.06630.0073	8MV 376 758-511	81 06101 6439	8MK 376 721-461
51.06630.0076	8MV 376 758-471	81 06101 6458	8MK 376 721-711
51.06630.0077	8MV 376 758-511	81 06101 6459	8MK 376 721-681
51.06630.0086	8MV 376 758-491	81 06101 6462	8MK 376 721-681
51.06630.0087	8MV 376 758-531	81 06101 6468	8MK 376 721-711
51.06630.0093	8MV 376 758-541	81 06101 6469	8MK 376 721-711
51.06630.0094	8MV 376 758-481	81 06101 6472	8MK 376 721-681
51.06630.0106	8MV 376 757-661	81 06101 6473	8MK 376 721-681
51.06630.0108	8MV 376 758-471	81 06101 6477	8MK 376 721-681
51.06630.0110	8MV 376 758-491	81 06101 6480	8MK 376 722-401
51.06630.0112	8MV 376 758-541	81 06101 6487	8MK 376 722-411
51.06630.0113	8MV 376 758-481	81 06101 6487	8MK 376 709-561
51.06630.0115	8MV 376 758-471	81 06101 9353	8MV 376 728-131
51.06630.0116	8MV 376 758-491	81 06630 6072	8MK 376 774-441
51.06630.0117	8MV 376 758-481	85.061.016.010	8MK 376 774-441
51.06630.0119	8MV 376 757-231	85.06101.6011	
51.06630.0129	8MV 376 757-251	NEOPLAN	HELLA
51.06630.0130	8MV 376 757-261	1107.807.9	8MK 376 722-401
51.06630.106	8MV 376 757-661	1111.708.1	8MA 376 705-241
51.06630.130	8MV 376 757-661	1114.233.6	8MK 376 722-241
51 06601 0250	8MV 376 733-131		
51 06630 0062	8MV 376 731-281		
51 06630 0066	8MV 376 731-281		
81.061.016.779	8MK 376 774-441		
81.06101.0058	8MK 376 756-011		
81.06101.0059	8MK 376 756-021		
81.06101.0060	8MK 376 755-401		
81.06101.0061	8MK 376 755-391		
81.06101.0063	8MK 376 755-411		
81.06101.0064	8MK 376 755-641		
81.06101.0065	8MK 376 755-651		
81.06101.6324	8MK 376 774-441		
81.06101.6384	8MK 376 709-561		
81.06101.6397	8MK 376 774-441		
81.06101.6407	8MK 376 721-481		
81.06101.6410	8MK 376 774-501		
81.06101.6446	8MK 376 774-441		
81.06101.6447	8MK 376 774-441		
81.06101.6482	8MK 376 728-661		
81.06101.6485	8MK 376 774-501		
81.06101.6492	8MK 376 728-671		
81.06101.6493	8MK 376 730-621		
81.06101.6502	8MK 376 755-421		
81.06101.6503	8MK 376 730-621		
81.06101.6510	8MK 376 721-711		
81.06101.6511	8MK 376 728-661		
81.06101.6512	8MK 376 721-681		
81.06101.6515	8MK 376 755-431		
81.06101.6518	8MK 376 721-711		
81.06101.6519	8MK 376 728-661		
81.06101.6520	8MK 376 721-681		
81.06101.6522	8MK 376 756-011		
81.06101.6523	8MK 376 756-021		
81.06101.6527	8MK 376 755-441		
81.06101.6529	8MK 376 749-821		
81.06102.6098	8MA 376 705-231		
81.06102.6098	8MA 376 705-241		
81.06102.6099	8MA 376 705-241		
81.06102.6100	8MA 376 705-251		
81.06102.6109	8MA 376 705-341		
81.06102.6110	8MA 376 705-331		
81.06102.6112	8MA 376 705-331		
81.06102.6117	8MA 376 705-381		
81.06102.6201	8MA 376 705-231		
81.06102.6201	8MA 376 705-241		
81.06102.6202	8MA 376 705-241		
81.06102.6203	8MA 376 705-251		
81.06102.6204	8MA 376 705-341		
81.06102.6205	8MA 376 705-331		
81.06102.6206	8MA 376 705-381		
81.06102.6208	8MA 376 705-381		
81.06102.6209	8MA 376 705-331		
81.06102.6218	8MA 376 705-241		
81.06102.6219	8MA 376 705-341		
81.06102.6220	8MA 376 705-251		
81.06102.6221	8MA 376 705-381		

8MA ...

8MA 376 705-231	520
8MA 376 705-241	520
8MA 376 705-251	521
8MA 376 705-331	521
8MA 376 705-341	522
8MA 376 705-381	522

8MK ...

8MK 376 709-561	509
8MK 376 721-461	509
8MK 376 721-481	510
8MK 376 721-681	510
8MK 376 721-711	511
8MK 376 721-761	511
8MK 376 722-241	512
8MK 376 722-401	512
8MK 376 722-411	513
8MK 376 728-661	513
8MK 376 728-671	514
8MK 376 730-621	514
8MK 376 737-041	514
8MK 376 749-821	515
8MK 376 755-391	515
8MK 376 755-401	515
8MK 376 755-411	516
8MK 376 755-421	516
8MK 376 755-431	516
8MK 376 755-441	517
8MK 376 755-641	517
8MK 376 755-651	517
8MK 376 756-011	518
8MK 376 756-021	518
8MK 376 774-441	519
8MK 376 774-501	519

8MV ...

8MV 376 728-131	505
8MV 376 731-281	500
8MV 376 733-131	506
8MV 376 757-221	500
8MV 376 757-231	500
8MV 376 757-251	500
8MV 376 757-261	500
8MV 376 757-271	505
8MV 376 757-421	506
8MV 376 757-661	501
8MV 376 757-671	501
8MV 376 757-681	501
8MV 376 757-721	506
8MV 376 757-731	507
8MV 376 758-471	502
8MV 376 758-481	502
8MV 376 758-491	503
8MV 376 758-511	503
8MV 376 758-531	504
8MV 376 758-541	504
8MV 376 758-551	504
8MV 376 758-561	507
8MV 376 758-571	508



Oil Cooler, engine oil.....	585
-----------------------------	-----

Heat Exchanger - Oil Cooler, engine oil

8MO 376 781-181
BEHR HELLA SERVICE

Depth [mm]	43
Length [mm]	552
Width [mm]	182



MAN.....587

Manufacturer - Model	Power	Displ.	Year of Constr.	Remark	Part Number	Page
MAN - E 2000						05/00→
19.310 FALK	228 kW		05/00→	Depth [mm]: 43; L 552 mm; W 182 mm	8MO 376 781-181 Oil	585
19.310 FALS	228 kW		05/00→			
19.310 FLK	228 kW		05/00→			
19.310 FLS	228 kW		05/00→			
19.360 FALK	265 kW		05/00→			
19.360 FALS	265 kW		05/00→			
19.360 FLK	265 kW		05/00→			
19.360 FLS	265 kW		05/00→			
19.410 FALK	301 kW		05/00→			
19.410 FALS	301 kW		05/00→			
19.410 FLK	301 kW		05/00→			
19.410 FLS	301 kW		05/00→			
26.310 FAVLC	228 kW		05/00→			
26.310 FAVLK	228 kW		05/00→			
26.360 FAVLC	265 kW		05/00→			
26.360 FAVLK	265 kW		05/00→			
26.410 DFARC	301 kW		05/00→			
26.410 DFRC, FAVLC	301 kW		05/00→			
26.410 FAVLK	301 kW		05/00→			
28.310 FNLC	228 kW		05/00→			
28.360 FANLC	265 kW		05/00→			
28.360 FANLK	265 kW		05/00→			
28.360 FNALC	265 kW		05/00→			
28.360 FNLC	265 kW		05/00→			
28.410 FANLC	301 kW		05/00→			
28.410 FANLK	301 kW		05/00→			
28.410 FNLC	301 kW		05/00→			
30.310 FNLC	228 kW		05/00→			
30.360 FANLC	265 kW		05/00→			
30.360 FANLK	265 kW		05/00→			
30.360 FNLC	265 kW		05/00→			
30.410 FANLC	301 kW		05/00→			
30.410 FANLK	301 kW		05/00→			
30.410 FNLC	301 kW		05/00→			
32.310 VFCL	228 kW		05/00→			
32.310 VFNLCL	228 kW		05/00→			
32.360 VFCL	265 kW		05/00→			
32.360 VFNLCL	265 kW		05/00→			
32.410 VFARK	301 kW		05/00→			
32.410 VFCL, VFRC, VFRLC	301 kW		05/00→			
32.410 VFNLCL	301 kW		05/00→			
33.360 DFAK, DFALK	265 kW		05/00→			
33.360 DFALC	265 kW		05/00→			
33.360 DFALS	265 kW		04/01→			
33.360 DFCL	265 kW		05/00→			
33.360 DFCL	265 kW		05/00→			
33.360 DFSL	265 kW		05/00→			
33.410 DFAK, DFALK	301 kW		05/00→			
33.410 DFALC	301 kW		05/00→			
33.410 DFALS	301 kW		04/01→			
33.410 DFCL	301 kW		05/00→			
33.410 DFCL	301 kW		05/00→			
33.410 DFSL	301 kW		05/00→			
35.360 VFAK	265 kW		05/00→			
35.410 FVNLC	301 kW		05/00→			
35.410 VFAK	301 kW		05/00→			
41.360 VFAK	265 kW		05/00→			
41.410 VFAK	301 kW		05/00→			
50.410 VFAK	301 kW		05/00→			
50.410 VFAVK, VFAV-G	301 kW		03/01→			
50.410 VFK	301 kW		05/00→			
50.410 VFVK, VFV-G	301 kW		10/00→			
MAN - F 2000						01/94→
19.314 FAS	228 kW		06/98→	Depth [mm]: 43; L 552 mm; W 182 mm	8MO 376 781-181 Oil	585
19.314 FC, FLC, FLLC, FLLW, FRC, FLRC, FLLRC, FLL, FLLR, F-N	228 kW		06/98→			
19.314 FK, FLK, F-KI, FL-KI	228 kW		06/98→			
19.314 FS, FLS, FLLS, FRS, FLRS, FLLRS	228 kW		06/98→			
19.364 FAC	265 kW		06/98→			
19.364 FAK, FA-KI	265 kW		06/98→			
19.364 FAS	265 kW		06/98→			
19.364 FC, FLC, FLLC, FLLW, FRC, FLRC, FLLRC, FLL, FLLR, F-N	265 kW		06/98→			
19.364 FK, FLK, F-KI, FL-KI	265 kW		06/98→			
19.364 FS, FLS, FLLS, FRS, FLRS, FLLRS	265 kW		06/98→			

Manufacturer - Model	Power	Displ.	Year of Constr.	Remark	Part Number	Page
MAN - F 2000						01/94→
19.373 FAC	272 kW		01/94→	Depth [mm]: 43; L 552 mm; W 182 mm	8MO 376 781-181 Oil Cooler, engine oil	585
19.373 FAK, FA-KI	272 kW		01/94→			
19.373 FAS	272 kW		01/94→			
19.373 FC, FLC, FLLC, FRC, FLRC, F-NL	272 kW		01/94→			
19.373 FK, FLK, F-KI, FL-KI	272 kW		01/94→			
19.403 FAC	294 kW		01/94→			
19.403 FAK, FA-KI	294 kW		01/94→			
19.403 FAS	294 kW		01/94→			
19.403 FC, FLC, FLLC, FRC, FLRC, F-NL	294 kW		01/94→			
19.403 FK, FLK, F-KI, FL-KI	294 kW		01/94→			
19.403 FS, FLS, FLLS, FRS, FLRS, FLLRS	294 kW		01/94→			
19.414 FAC	301 kW		06/98→			
19.414 FAK, FA-KI	301 kW		06/98→			
19.414 FAS	301 kW		06/98→			
19.414 FC, FLC, FLLC, FRC, FLRC, FLLRC, FLL, FLLR, F-NL	301 kW		06/98→			
19.414 FK, FLK, F-KI, FL-KI	301 kW		06/98→			
19.414 FS, FLS, FLLS, FRS, FLRS, FLLRS	301 kW		06/98→			
19.423 FAC	309 kW		01/94→12/95			
19.423 FAK, FA-KI	309 kW		01/94→			
19.423 FAS	309 kW		01/94→12/95			
19.423 FC, FLC, FLLC, F-NL	309 kW		01/94→			
19.423 FK, FLK, F-KI, FL-KI	309 kW		01/94→			
19.423 FS, FLS, FLLS	309 kW		01/94→			
23.403 FNLLC	294 kW		01/94→			
24.373 FNLLC	272 kW		01/94→12/95			
24.403 FNLLC	294 kW		01/94→			
24.423 FNLLC	309 kW		01/94→12/95			
26.314 DFK, DFLK	228 kW		05/01→			
26.314 DFS, DFSL	228 kW		05/01→			
26.314 DF-TM	228 kW		05/01→			
26.314 FNLC, FNLLC, FNLLRC, FNLLW, FVLC	228 kW		05/01→			
26.314 FNLS	228 kW		05/01→			
26.314 FVL-KO	228 kW		05/01→			
26.314 FVLS, FVLRS	228 kW		05/01→			
26.364 DFC, DFCL	265 kW		05/01→			
26.364 DFK, DFLK	265 kW		05/01→			
26.364 DFS, DFSL	265 kW		05/01→			
26.364 DF-TM	265 kW		05/01→			
26.364 FNLC, FNLLC, FNLLRC, FNLLW, FVLC	265 kW		05/01→			
26.364 FNLS	265 kW		05/01→			
26.364 FVL-KO	265 kW		05/01→			
26.364 FVLS, FVLRS	265 kW		05/01→			
26.373 DFC,26.373 DFCL	272 kW		01/94→12/95			
26.373 DFK,26.373 DFLK	272 kW		01/94→12/95			
26.373 DFS,26.373 DFSL	272 kW		01/94→12/95			
26.373 FNLC,26.373 FNLLC, 26.373 FVLC	272 kW		01/94→12/95			
26.373 FNLS,26.373 FVLS	272 kW		01/94→12/95			
26.403 DFC,26.403 DFCL	294 kW		01/94→			
26.403 DFK,26.403 DFLK	294 kW		01/94→			
26.403 DFS,26.403 DFSL	294 kW		01/94→			
26.403 FNLC,26.403 FNLLC, 26.403 FVLC	294 kW		01/94→			
26.403 FNLS,26.403 FVLS	294 kW		01/94→			
26.414 DFC, DFCL	301 kW		05/01→			
26.414 DFK, DFLK	301 kW		05/01→			
26.414 DFS, DFSL	301 kW		05/01→			
26.414 DF-TM	301 kW		05/01→			
26.414 FNLC, FNLLC, FNLLRC, FNLLW, FVLC	301 kW		05/01→			
26.414 FNLS	301 kW		05/01→			
26.414 FVL-KO	301 kW		05/01→			
26.414 FVLS, FVLRS	301 kW		05/01→			
26.423 DFC,26.423 DFCL	309 kW		01/94→12/95			
26.423 DFK,26.423 DFLK	309 kW		01/94→12/95			
26.423 DFS,26.423 DFSL	309 kW		01/94→12/95			
26.423 FNLC,26.423 FNLLC, 26.423 FVLC	309 kW		01/94→12/95			
26.423 FNLS,26.423 FVLS	309 kW		01/94→12/95			
27.314 DFAC	228 kW		05/01→			
27.314 FVL	228 kW		06/98→			
27.364 DFAC	265 kW		05/01→			
27.364 FVL	265 kW		06/98→			
27.373 DFAC	272 kW		01/94→			

Manufacturer - Model	Power	Displ.	Year of Constr.	Remark	Part Number	Page
MAN - F 2000						01/94→
27.373 DFAK, DFA-KI	272 kW		01/94→	Depth [mm]: 43; L 552 mm; W 182 mm	8MO 376 781-181 Oil	585
27.373 DFAS	272 kW		01/94→			
27.373 DFC	272 kW		01/94→			
27.373 DFK, DF-KI	272 kW		01/94→			
27.373 DFS	272 kW		01/94→			
27.403 DFAC	294 kW		01/94→			
27.403 DFAK, DFA-KI	294 kW		01/94→			
27.403 DFAS	294 kW		01/94→			
27.403 DFC	294 kW		01/94→			
27.403 DFK, DF-KI	294 kW		01/94→			
27.403 DFS	294 kW		01/94→			
27.414 DFAC	301 kW		05/01→			
27.414 FVL	301 kW		06/98→			
27.423 DFAC	309 kW		01/94→			
27.423 DFAK, DFA-KI	309 kW		01/94→			
27.423 DFAS	309 kW		01/94→12/95			
27.423 DFC	309 kW		01/94→			
27.423 DFK, DF-KI	309 kW		01/94→			
27.423 DFS	309 kW		01/94→			
32.314 VF, VFC	228 kW		05/01→			
32.314 VFK, VF-HK	228 kW		05/01→			
32.314 VF-TM	228 kW		05/01→			
32.364 VF, VFC	265 kW		05/01→			
32.364 VFK, VF-HK	265 kW		05/01→			
32.364 VF-TM	265 kW		05/01→			
32.403 VFC	294 kW		08/95→			
32.403 VFK	294 kW		08/95→			
32.414 VF, VFC	301 kW		05/01→			
32.414 VFK, VF-HK	301 kW		05/01→			
32.414 VF-TM	301 kW		05/01→			
33.373 DFAC	272 kW		01/94→			
33.373 DFAK, DFA-KI	272 kW		01/94→			
33.373 DFAS	272 kW		01/94→			
33.373 DFC	272 kW		01/94→			
33.373 DFK, DF-KI	272 kW		01/94→			
33.373 DFS, DFRS	272 kW		01/94→			
33.403 DFAC	294 kW		01/94→			
33.403 DFAK, DFA-KI	294 kW		01/94→			
33.403 DFAS	294 kW		01/94→			
33.403 DFC	294 kW		01/94→			
33.403 DFK, DF-KI	294 kW		01/94→			
33.403 DFS, DFRS	294 kW		01/94→			
33.423 DFAC	309 kW		01/94→			
33.423 DFAK, DFA-KI	309 kW		01/94→			
33.423 DFAS	309 kW		01/94→			
33.423 DFC	309 kW		01/94→			
33.423 DFK, DF-KI	309 kW		01/94→			
33.423 DFS, DFRS	309 kW		01/94→			
35.364 VF, VFC, VFRC	265 kW		05/01→			
35.364 VFK, VF-HK, VF-KI	265 kW		03/02→			
35.364 VF-TM	265 kW		03/02→			
35.403 VF, VFC, VFRC	294 kW		08/95→			
35.403 VFK, VF-HK, VF-KI	294 kW		03/02→			
35.414 VF, VFC, VFRC	301 kW		05/01→			
35.414 VFK, VF-HK, VF-KI	301 kW		03/02→			
35.414 VF-TM	301 kW		03/02→			
37.414 VFA	301 kW		06/98→			
40.403 DFAK	294 kW		01/94→			
40.403 DFAS	294 kW		01/94→			
40.403 DFK	294 kW		01/94→			
40.403 DFS	294 kW		01/94→			
41.403 VF, VFC, VFRC	294 kW		08/95→			
41.403 VFK, VF-HK, VF-KI	294 kW		08/95→			
MAN - LION S COACH						09/95→
FRH 352,RH 353	257 kW		09/95→	Depth [mm]: 43; L 552 mm; W 182 mm	8MO 376 781-181 Oil	585
FRH 402,RH 403	294 kW		09/95→			
RH 402	294 kW		09/98→			
RH 413	301 kW		01/00→			
RH 463, RHC 464	338 kW		01/00→			
RHC 414	301 kW		06/02→			
MAN - LION S STAR						01/93→
FRH 352,RH 353	257 kW		09/95→	Depth [mm]: 43; L 552 mm; W 182 mm	8MO 376 781-181 Oil	585
FRH 402,RH 403	294 kW		09/95→			
FRH 422	309 kW		01/93→09/96			
RH 464, RHS 464	301 kW		03/00→			
RH 464, RHS 464	301 kW		01/02→			
RH 414	338 kW		03/00→			
RH 464, RHS 464	338 kW		01/02→			



MAN	HELLA
81.32560.6062	8MO 376 781-181
81.32560.6069	8MO 376 781-181



8MO ...
8MO 376 781-181 585



Intercooler, charger.....	593
Radiator Core, intercooler.....	599

Heat Exchanger - Intercooler, charger

8ML 376 723-741
BEHR HELLA SERVICE

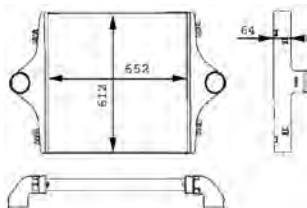

Depth [mm]	66
Length [mm]	652
Version	produced by BEHR
Width [mm]	612

Spare Parts

1 x 8MY 376 744-371 Radiator Core, intercooler

8ML 376 723-751
BEHR HELLA SERVICE

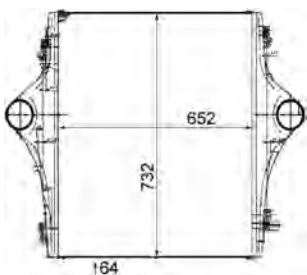

Depth [mm]	64
Length [mm]	652
Version	produced by BEHR
Width [mm]	732

8ML 376 723-761
BEHR HELLA SERVICE

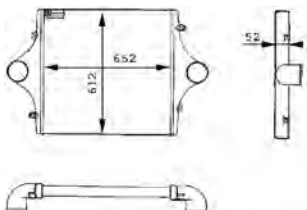

Depth [mm]	52
Length [mm]	652
Version	produced by BEHR
Width [mm]	612

Heat Exchanger - Intercooler, charger

8ML 376 724-201
BEHR HELLA SERVICE

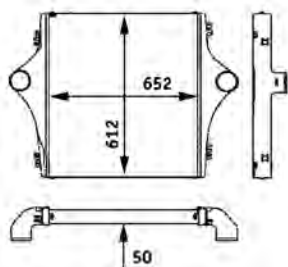

Depth [mm]	50
Length [mm]	652
Version	produced by BEHR
Width [mm]	612

8ML 376 724-211
BEHR HELLA SERVICE

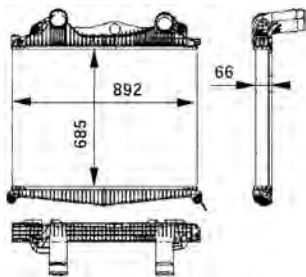

Depth [mm]	66
for OE number	81061300170/5
Length [mm]	685
Version	produced by BEHR
Width [mm]	892

8ML 376 724-221
BEHR HELLA SERVICE

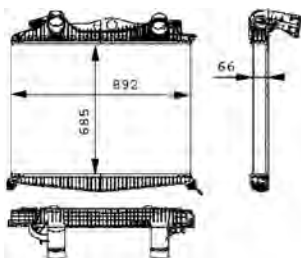

Depth [mm]	66
for OE number	81061300176/8
Length [mm]	685
Version	produced by BEHR
Width [mm]	892

Heat Exchanger - Intercooler, charger

8ML 376 724-321
BEHR HELLA SERVICE

Plastic-air tank

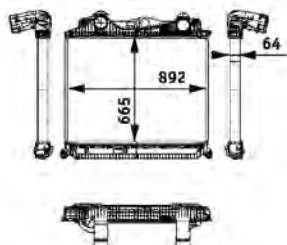

Depth [mm]	64
for OE number	81061300216
Length [mm]	665
Observe technical data	1
Version	produced by BEHR
Width [mm]	892

8ML 376 724-351
BEHR HELLA SERVICE

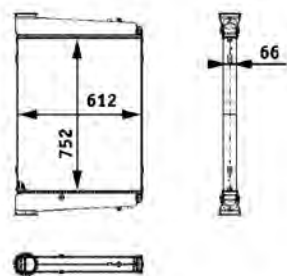

Depth [mm]	66
Length [mm]	752
Version	produced by BEHR
Width [mm]	612

8ML 376 724-361
BEHR HELLA SERVICE

Alu-air tank

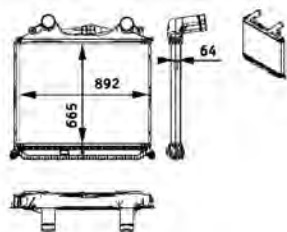

Depth [mm]	64
Length [mm]	665
Version	produced by BEHR
Width [mm]	892

Heat Exchanger - Intercooler, charger

8ML 376 724-371
BEHR HELLA SERVICE

Alu-air tank

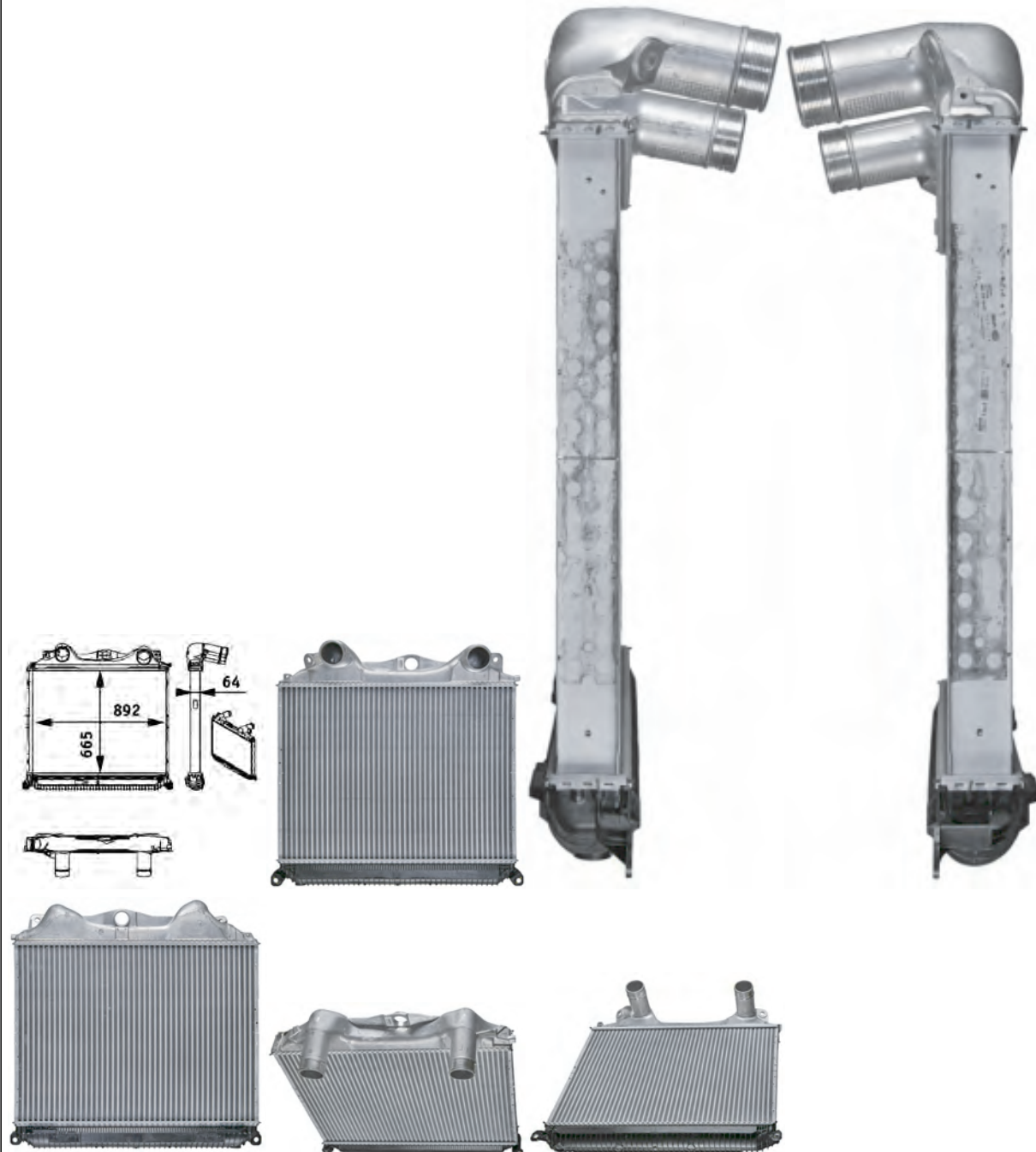

Depth [mm]	64
Length [mm]	892
Version	produced by BEHR
Width [mm]	665

Heat Exchanger - Intercooler, charger

8ML 376 724-381
BEHR HELLA SERVICE

Plastic-air tank

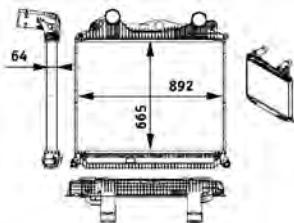

Depth [mm]	64
for OE number	81061300215
Length [mm]	665
Observe technical data	1
Version	produced by BEHR
Width [mm]	892

8ML 376 724-431
BEHR HELLA SERVICE

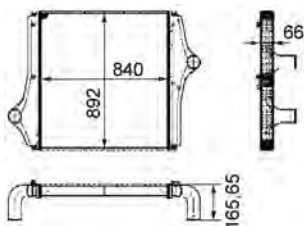

Depth [mm]	66
Length [mm]	840
Version	produced by BEHR
Width [mm]	892

8ML 376 728-701
BEHR HELLA SERVICE

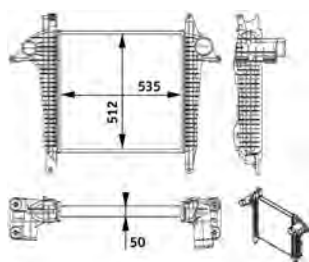

Depth [mm]	50
Length [mm]	535
Version	produced by BEHR
Width [mm]	512

Heat Exchanger - Intercooler, charger

8ML 376 733-401
BEHR HELLA SERVICE

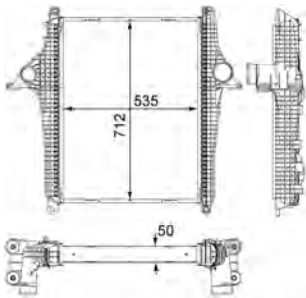

Depth [mm]	50
Length [mm]	535
Version	produced by BEHR
Width [mm]	712

8ML 376 746-301
BEHR HELLA SERVICE

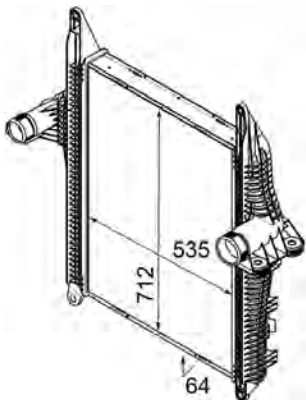

Depth [mm]	64
Length [mm]	712
Version	produced by BEHR
Width [mm]	535

8ML 376 746-311
BEHR HELLA SERVICE

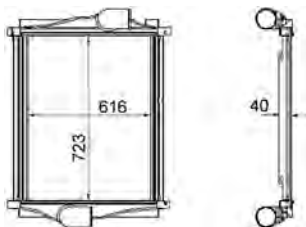

Depth [mm]	40
Length [mm]	723
Width [mm]	617

Heat Exchanger - Intercooler, charger

8ML 376 755-451
BEHR HELLA SERVICE



Depth [mm]	64
Length [mm]	931
to year	2008
Version	produced by BEHR
Width [mm]	732

8ML 376 755-461
BEHR HELLA SERVICE



Depth [mm]	64
Length [mm]	931
Version	produced by BEHR
Width [mm]	732

8ML 376 756-001
BEHR HELLA SERVICE

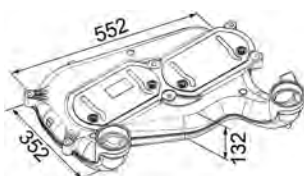

Charge Type	Indirect charge air cooler
Depth [mm]	132
Length [mm]	552
Version	produced by BEHR
Width [mm]	352

Heat Exchanger - Radiator Core, intercooler

8MY 376 744-371
BEHR HELLA SERVICE

Core Intercooler

Depth [mm]	64
Length [mm]	652
Version	produced by BEHR
Width [mm]	612



MAN.....601

Manufacturer - Model	Power	Displ.	Year of Constr.	Remark	Part Number	Page
MAN - E 2000						05/00→
19.310 FALK	228 kW		05/00→	Depth [mm]: 64; L 652 mm; Vers. produced by BEHR; W 732 mm	8ML 376 723-751 Intercooler, charger	593
19.310 FALS	228 kW		05/00→			
19.310 FLK	228 kW		05/00→	Depth [mm]: 50; L 652 mm; Vers. produced by BEHR; W 612 mm	8ML 376 724-201 Intercooler, charger	594
19.310 FLS	228 kW		05/00→			
19.360 FALK	265 kW		05/00→			
19.360 FALS	265 kW		05/00→			
19.360 FLK	265 kW		05/00→			
19.360 FLS	265 kW		05/00→			
19.410 FALK	301 kW		05/00→			
19.410 FALS	301 kW		05/00→			
19.410 FLK	301 kW		05/00→			
19.410 FLS	301 kW		05/00→			
19.460 FALK	338 kW		05/00→			
19.460 FALS	338 kW		05/00→			
19.460 FLK	338 kW		05/00→			
19.460 FLS	338 kW		05/00→			
26.310 FAVLC	228 kW		05/00→			
26.310 FAVLK	228 kW		05/00→			
26.360 FAVLC	265 kW		05/00→			
26.360 FAVLK	265 kW		05/00→			
26.410 DFARC	301 kW		05/00→			
26.410 DFRC, FAVLC	301 kW		05/00→			
26.410 FAVLK	301 kW		05/00→			
26.460 DFARC	338 kW		05/00→			
26.460 DFLRS	338 kW		05/00→			
26.460 FAVLC	338 kW		05/00→			
26.460 FAVLK	338 kW		05/00→			
28.310 FNLC	228 kW		05/00→			
28.360 FANLC	265 kW		05/00→			
28.360 FANLK	265 kW		05/00→			
28.360 FNALC	265 kW		05/00→			
28.360 FNLC	265 kW		05/00→			
28.410 FANLC	301 kW		05/00→			
28.410 FANLK	301 kW		05/00→			
28.410 FNLC	301 kW		05/00→			
28.460 FANLC	338 kW		05/00→			
28.460 FANLK	338 kW		05/00→			
28.460 FNLC	338 kW		05/00→			
29.460 FVAS	338 kW		05/00→			
30.310 FNLC	228 kW		05/00→			
30.360 FANLC	265 kW		05/00→			
30.360 FANLK	265 kW		05/00→			
30.360 FNLC	265 kW		05/00→			
30.410 FANLC	301 kW		05/00→			
30.410 FANLK	301 kW		05/00→			
30.410 FNLC	301 kW		05/00→			
30.460 FANLC	338 kW		05/00→			
30.460 FANLK	338 kW		05/00→			
30.460 FNLC	338 kW		05/00→			
32.310 VFCL	228 kW		05/00→			
32.310 VFNLCL	228 kW		05/00→			
32.360 VFCL	265 kW		05/00→			
32.360 VFNLCL	265 kW		05/00→			
32.410 VFARK	301 kW		05/00→			
32.410 VFCL, VFRC, VFRLC	301 kW		05/00→			
32.410 VFNLCL	301 kW		05/00→			
32.460 VFCL, VFRLC	338 kW		05/00→			
32.460 VFNLCL	338 kW		05/00→			
33.360 DFAK, DFALK	265 kW		05/00→			
33.360 DFALC	265 kW		05/00→			
33.360 DFALS	265 kW		04/01→			
33.360 DFCL	265 kW		05/00→			
33.360 DFLK	265 kW		05/00→			
33.360 DFSL	265 kW		05/00→			
33.410 DFAK, DFALK	301 kW		05/00→			
33.410 DFALC	301 kW		05/00→			
33.410 DFALS	301 kW		04/01→			
33.410 DFCL	301 kW		05/00→			
33.410 DFLK	301 kW		05/00→			
33.410 DFSL	301 kW		05/00→			
33.460 DFAK, DFALK	338 kW		05/00→			
33.460 DFALC	338 kW		05/00→			
33.460 DFALS	338 kW		04/01→			
33.460 DFCL	338 kW		05/00→			
33.460 DFLK	338 kW		05/00→			
33.460 DFSL	338 kW		05/00→			
35.360 VFAK	265 kW		05/00→			
35.410 FVNLC	301 kW		05/00→			
35.410 VFAK	301 kW		05/00→			
35.460 FVNLC	338 kW		05/00→			
35.460 VFAK	338 kW		05/00→			

Manufacturer - Model	Power	Displ.	Year of Constr.	Remark	Part Number	Page			
MAN - E 2000						05/00→			
41.360 VFAK	265 kW		05/00→	Depth [mm]: 64; L 652 mm; Vers. produced by BEHR; W 732 mm	8ML 376 723-751 Intercooler, charger	593			
41.410 VFAK	301 kW		05/00→						
41.460 DFVS, DFVLS	338 kW		06/00→	Depth [mm]: 50; L 652 mm; Vers. produced by BEHR; W 612 mm	8ML 376 724-201 Intercooler, charger	594			
41.460 VFAK	338 kW		05/00→						
50.410 VFAK	301 kW		05/00→						
50.410 VFAVK, VFAV-G	301 kW		03/01→						
50.410 VFK	301 kW		05/00→						
50.410 VFKV, VFKV-G	301 kW		10/00→						
50.460 VFAK	338 kW		05/00→						
50.460 VFAVK, VFAV-G	338 kW		03/01→						
50.460 VFK	338 kW		05/00→						
50.460 VFKV, VFKV-G	338 kW		10/00→						
41.600 DFVS, DFVLS	441 kW		06/00→	Depth [mm]: 64; L 652 mm; Vers. produced by BEHR; W 732 mm	8ML 376 723-751 Intercooler, charger	593			
MAN - EL						01/93→			
EL 202,EL 222	157 - 169 kW		01/93→06/97	Depth [mm]: 40; L 723 mm; W 617 mm	8ML 376 746-311 Intercooler, charger	598			
EL 202,EL 262	184 kW		04/94→06/97						
EL 262	191 kW		07/98→						
MAN - F 90						07/86→02/90			
19.362 F, 19.362 FL, 19.362 FLL	265 kW		07/86→02/90	Depth [mm]: 52; L 652 mm; Vers. produced by BEHR; W 612 mm	8ML 376 723-761 Intercooler, charger	593			
19.362 FK	265 kW		07/86→02/90						
19.362 FS, 19.362 FLS, 19.362 FLLS	265 kW		07/86→02/90	Depth [mm]: 52; L 652 mm; Vers. produced by BEHR; W 612 mm	8ML 376 723-761 Intercooler, charger	593			
24.362 FNL, 24.362 FNLL, 24.362 FVL	265 kW		10/86→02/90						
24.362 FNLS, 24.362 FVLS	265 kW		10/86→02/90						
MAN - F 2000						01/94→			
19.233 FKNG	170 kW			Depth [mm]: 66; L 652 mm; Vers. produced by BEHR; W 612 mm	8ML 376 723-741 Intercooler, charger	593			
26.233 FVL-KO	170 kW		03/00→						
27.314 FVL	228 kW		06/98→	Depth [mm]: 66; L 652 mm; Vers. produced by BEHR; W 612 mm	8ML 376 723-741 Intercooler, charger	593			
27.364 FVL	265 kW		06/98→						
27.414 FVL	301 kW		06/98→						
27.464 FVL	338 kW		06/98→						
37.414 VFA	301 kW		06/98→						
37.464 VFA	338 kW		06/98→						
19.293 FAC	213 kW		01/94→				Depth [mm]: 66; L 652 mm; Vers. produced by BEHR; W 612 mm	8ML 376 723-741 Intercooler, charger	593
19.293 FAK	213 kW		01/94→						
19.293 FAS	213 kW		01/94→				Depth [mm]: 64; L 652 mm; Vers. produced by BEHR; W 612 mm	8MY 376 744-371 Radiator Core, intercooler	599
19.293 FC, 19.293 FLC, 19.293 FLLC	213 kW		01/94→						
19.293 FK, 19.293 FLK	213 kW		01/94→	Depth [mm]: 64; L 652 mm; Vers. produced by BEHR; W 612 mm	8MY 376 744-371 Radiator Core, intercooler	599			
19.293 FS, 19.293 FLS, 19.293 FLLS	213 kW		01/94→						
19.323 FAC	235 kW		01/94→12/95						
19.323 FAK	235 kW		01/94→12/95						
19.323 FAS	235 kW		01/94→12/95						
19.323 FC, 19.323 FLC, 19.323 FLLC	235 kW		01/94→12/95						
19.323 FK, 19.323 FLK	235 kW		01/94→12/95						
19.323 FS, 19.323 FLS, 19.323 FLLS	235 kW		01/94→12/95						
23.293 FNLLC	213 kW		01/94→						
23.343 FNLLC	250 kW		01/94→						
23.463 FNLLC	338 kW		01/94→						
24.293 FNLLC	213 kW		01/94→						
24.343 FNLLC	250 kW		01/94→						
26.293 DFC, 26.293 DFCL	213 kW		01/94→						
26.293 DFS, 26.293 DFSL	213 kW		01/94→						
26.293 FNLC, 26.293 FNLLC, 26.293 FVLC	213 kW		01/94→						
26.293 FNLS, 26.293 FVLS	213 kW		01/94→						
26.323 DFC, 26.323 DFCL	235 kW		01/94→12/95						
26.323 DFK, 26.323 DFLLK	235 kW		01/94→12/95						
26.323 DFS, 26.323 DFSL	235 kW		01/94→12/95						
26.343 DFC, 26.343 DFCL	250 kW		01/94→						
26.343 DFK, 26.343 DFLLK	250 kW		01/94→						
26.343 DFS, 26.343 DFSL	250 kW		01/94→						
26.343 FNLC, 26.343 FNLLC, 26.343 FVLC	250 kW		01/94→						
26.343 FNLS, 26.343 FVLS	250 kW		01/94→						
27.293 DFAC	213 kW		01/94→						
27.293 DFAK	213 kW		01/94→						
27.293 DFAS	213 kW		01/94→						
27.293 DFC	213 kW		01/94→						
27.293 DFK	213 kW		01/94→						
27.293 DFS	213 kW		01/94→						

Manufacturer - Model	Power	Displ.	Year of Constr.	Remark	Part Number	Page
MAN - F 2000						01/94→
27.343 DFAC	250 kW		01/94→	Depth [mm]: 66; L 652 mm; Vers. produced by BEHR; W 612 mm	8ML 376 723-741 Intercooler, charger	593
27.343 DFAK	250 kW		01/94→			
27.343 DFC	250 kW		01/94→	Depth [mm]: 64; L 652 mm; Vers. produced by BEHR; W 612 mm	8MY 376 744-371 Radiator Core, intercooler	599
27.343 DFK	250 kW		01/94→			
27.343 DFS	250 kW		01/94→			
32.293 VFC	213 kW		08/95→			
32.343 VFC	250 kW		08/95→			
35.343 VFC	250 kW		08/95→			
35.343 VFK	250 kW		08/95→			
41.343 VFC	250 kW		08/95→			
41.343 VFK	250 kW		08/95→			
19.314 FAC	228 kW		05/01→			
19.314 FAK, FA-KI	228 kW		05/01→			
19.314 FAS	228 kW		06/98→			
19.314 FC, FLC, FLLC, FLLW, FRC, FLRC, FLLRC, FLL, FLLR, F-N	228 kW		06/98→			
19.314 FK, FLK, F-KI, FL-KI	228 kW		06/98→			
19.314 FS, FLS, FLLS, FRS, FLRS, FLLRS	228 kW		06/98→			
19.364 FAC	265 kW		06/98→			
19.364 FAK, FA-KI	265 kW		06/98→			
19.364 FAS	265 kW		06/98→			
19.364 FC, FLC, FLLC, FLLW, FRC, FLRC, FLLRC, FLL, FLLR, F-N	265 kW		06/98→			
19.364 FK, FLK, F-KI, FL-KI	265 kW		06/98→			
19.364 FS, FLS, FLLS, FRS, FLRS, FLLRS	265 kW		06/98→			
19.373 FAK, FA-KI	272 kW		01/94→			
19.373 FAS	272 kW		01/94→			
19.373 FC, FLC, FLLC, FRC, FLRC, F-NL	272 kW		01/94→			
19.373 FK, FLK, F-KI, FL-KI	272 kW		01/94→			
19.373 FS, FLS, FLLS, FRS, FLRS, FLLRS	272 kW		01/94→			
19.414 FAC	301 kW		06/98→			
19.414 FAK, FA-KI	301 kW		06/98→			
19.414 FAS	301 kW		06/98→			
19.414 FC, FLC, FLLC, FRC, FLRC, FLLRC, FLL, FLLR, F-NL	301 kW		06/98→			
19.414 FK, FLK, F-KI, FL-KI	301 kW		06/98→			
19.414 FS, FLS, FLLS, FRS, FLRS, FLLRS	301 kW		06/98→			
19.423 FAC	309 kW		01/94→12/95			
19.423 FAK, FA-KI	309 kW		01/94→			
19.423 FAS	309 kW		01/94→12/95			
19.423 FC, FLC, FLLC, F-NL	309 kW		01/94→			
19.423 FK, FLK, F-KI, FL-KI	309 kW		01/94→			
19.423 FS, FLS, FLLS	309 kW		01/94→			
19.463 FAC	338 kW		01/94→			
19.463 FAK, FA-KI	338 kW		01/94→			
19.463 FAS	338 kW		01/94→			
19.463 FC, FLC, FLLC, FRC, FLRC, F-NL	338 kW		01/94→			
19.463 FK, FLK, F-KI, FL-KI	338 kW		01/94→			
19.463 FS, FLS, FLLS, FRS, FLRS, FLLRS	338 kW		01/94→			
19.464 FAC	338 kW		06/98→			
19.464 FAK, FA-KI	338 kW		06/98→			
19.464 FAS	338 kW		06/98→			
19.464 FC, FLC, FLLC, FLL, FRC, FLLR, FLLRC, FLLW, F-NL	338 kW		06/98→			
19.464 FK, FLK, F-KI, FL-KI	338 kW		06/98→			
19.464 FS, FLS, FLLS, FRS, FLRS, FLLRS	338 kW		06/98→			
23.314 FNLLC	228 kW		05/01→			
23.364 FNLLC	265 kW		05/01→			
23.414 FNLLC	301 kW		05/01→			
23.464 FNLLC	338 kW		05/01→			
24.314 FNLLRC	228 kW		05/01→			
24.364 FNLLRC	265 kW		05/01→			
24.373 FNLLC	272 kW		01/94→12/95			
24.414 FNLLRC	301 kW		05/01→			
24.423 FNLLC	309 kW		01/94→12/95			
24.463 FNLLC	338 kW		01/94→			
24.464 FNLLRC	338 kW		05/01→			
26.314 DFC, DFCL	228 kW		05/01→			
26.314 DFK, DFLK	228 kW		05/01→			
26.314 DFS, DFSL	228 kW		05/01→			
26.314 DF-TM	228 kW		05/01→			

Manufacturer - Model	Power	Displ.	Year of Constr.	Remark	Part Number	Page
MAN - F 2000						01/94→
26.314 FNLC, FNLLC, FNLLRC, FNLLW, FVLC	228 kW		05/01→	Depth [mm]: 64; L 652 mm; Vers. produced by BEHR; W 732 mm	8ML 376 723-751 Intercooler, charger	593
26.314 FNLS	228 kW		05/01→			
26.314 FVL-KO	228 kW		05/01→			
26.314 FVLS, FVLRS	228 kW		05/01→			
26.364 DFC, DFLC	265 kW		05/01→			
26.364 DFK, DFLK	265 kW		05/01→			
26.364 DFS, DFSL	265 kW		05/01→			
26.364 DF-TM	265 kW		05/01→			
26.364 FNLC, FNLLC, FNLLRC, FNLLW, FVLC	265 kW		05/01→			
26.364 FNLS	265 kW		05/01→			
26.364 FVL-KO	265 kW		05/01→			
26.364 FVLS, FVLRS	265 kW		05/01→			
26.414 DFC, DFLC	301 kW		05/01→			
26.414 DFK, DFLK	301 kW		05/01→			
26.414 DFS, DFSL	301 kW		05/01→			
26.414 DF-TM	301 kW		05/01→			
26.414 FNLC, FNLLC, FNLLRC, FNLLW, FVLC	301 kW		05/01→			
26.414 FNLS	301 kW		05/01→			
26.414 FVL-KO	301 kW		05/01→			
26.414 FVLS, FVLRS	301 kW		05/01→			
26.423 DFC,26.423 DFLC	309 kW		01/94→12/95			
26.423 DFK,26.423 DFLK	309 kW		01/94→12/95			
26.423 DFS,26.423 DFSL	309 kW		01/94→12/95			
26.423 FNLC,26.423 FNLLC, 26.423 FVLC	309 kW		01/94→12/95			
26.423 FNLS,26.423 FVLS	309 kW		01/94→12/95			
26.463 DFC, DFLC	338 kW		01/94→			
26.463 DFK,26.463 DFLK	338 kW		01/94→			
26.463 DFS,26.463 DFSL	338 kW		01/94→			
26.463 FNLC, FNLLC, FVLC	338 kW		01/94→			
26.463 FNLS,26.463 FVLS	338 kW		01/94→			
26.464 DFC, DFLC	338 kW		05/01→			
26.464 DFK, DFLK	338 kW		05/01→			
26.464 DFS, DFSL	338 kW		05/01→			
26.464 DF-TM	338 kW		05/01→			
26.464 FNLC, FNLLC, FNLLW, FVLC	338 kW		05/01→			
26.464 FNLS	338 kW		05/01→			
26.464 FVL-KO	338 kW		05/01→			
26.464 FVLS, FVLRS	338 kW		05/01→			
27.314 DFAC	228 kW		05/01→			
27.314 DFAK, DFA-KI	228 kW		05/01→			
27.314 DFAS	228 kW		05/01→			
27.314 DFC	228 kW		05/01→			
27.314 DFK, DF-KI	228 kW		05/01→			
27.314 DFS	228 kW		05/01→			
27.314 DF-TM	228 kW		05/01→			
27.364 DFAC	265 kW		05/01→			
27.364 DFAK, DFA-KI	265 kW		05/01→			
27.364 DFAS	265 kW		05/01→			
27.364 DFC	265 kW		05/01→			
27.364 DFK, DF-KI	265 kW		05/01→			
27.364 DFS	265 kW		05/01→			
27.364 DF-TM	265 kW		05/01→			
27.373 DF-TM	272 kW		07/00→			
27.414 DFAC	301 kW		05/01→			
27.414 DFAK, DFA-KI	301 kW		05/01→			
27.414 DFAS	301 kW		05/01→			
27.414 DFC	301 kW		05/01→			
27.414 DFK, DF-KI	301 kW		05/01→			
27.414 DFS	301 kW		05/01→			
27.414 DF-TM	301 kW		05/01→			
27.423 DFAC	309 kW		01/94→			
27.423 DFAK, DFA-KI	309 kW		01/94→			
27.423 DFAS	309 kW		01/94→12/95			
27.423 DFC	309 kW		01/94→			
27.423 DFK, DF-KI	309 kW		01/94→			
27.423 DFS	309 kW		01/94→			
27.423 DF-TM	309 kW		07/00→			
27.463 DFAC	338 kW		01/94→			
27.463 DFAK, DFA-KI	338 kW		01/94→			
27.463 DFAS	338 kW		01/94→			
27.463 DFC	338 kW		01/94→			
27.463 DFK, DF-KI	338 kW		01/94→			
27.463 DFS	338 kW		01/94→			
27.463 DF-TM	338 kW		07/00→			
27.464 DFAC	338 kW		05/01→			
27.464 DFAK, DFA-KI	338 kW		05/01→			

Manufacturer - Model	Power	Displ.	Year of Constr.	Remark	Part Number	Page
MAN - F 2000						01/94→
27.464 DFAS	338 kW		05/01→	Depth [mm]: 64; L 652 mm; Vers. produced by BEHR; W 732 mm	8ML 376 723-751 Intercooler, charger	593
27.464 DFC	338 kW		01/94→			
27.464 DFK, DF-KI	338 kW		05/01→			
27.464 DFS	338 kW		01/94→			
27.464 DF-TM	338 kW		05/01→			
32.314 VF, VFC	228 kW		05/01→			
32.314 VFK, VF-HK	228 kW		05/01→			
32.314 VF-TM	228 kW		05/01→			
32.364 VF, VFC	265 kW		05/01→			
32.364 VFK, VF-HK	265 kW		05/01→			
32.364 VF-TM	265 kW		05/01→			
32.414 VF, VFC	301 kW		05/01→			
32.414 VFK, VF-HK	301 kW		05/01→			
32.414 VF-TM	301 kW		05/01→			
32.463 VFC	338 kW		08/95→			
32.463 VFK	338 kW		08/95→			
32.464 VF, VFC	338 kW		05/01→			
32.464 VFK, VF-HK	338 kW		05/01→			
32.464 VF-TM	338 kW		05/01→			
33.364 DFAC	265 kW		05/01→			
33.364 DFAK, DFA-KI	265 kW		05/01→			
33.364 DFAS	265 kW		05/01→			
33.364 DFC	265 kW		05/01→			
33.364 DFK, DF-KI	265 kW		05/01→			
33.364 DFS, DFRS	265 kW		05/01→			
33.373 DFAC	272 kW		01/94→			
33.373 DFAK, DFA-KI	272 kW		01/94→			
33.373 DFAS	272 kW		01/94→			
33.373 DFC	272 kW		01/94→			
33.373 DFK, DF-KI	272 kW		01/94→			
33.373 DFS, DFRS	272 kW		01/94→			
33.414 DFAC	301 kW		05/01→			
33.414 DFAK, DFA-KI	301 kW		05/01→			
33.414 DFAS	301 kW		05/01→			
33.414 DFC	301 kW		05/01→			
33.414 DFK, DF-KI	301 kW		05/01→			
33.414 DFS, DFRS	301 kW		05/01→			
33.423 DFAC	309 kW		01/94→			
33.423 DFAK, DFA-KI	309 kW		01/94→			
33.423 DFAS	309 kW		01/94→			
33.423 DFC	309 kW		01/94→			
33.423 DFK, DF-KI	309 kW		01/94→			
33.423 DFS, DFRS	309 kW		01/94→			
33.463 DFAC	338 kW		01/94→			
33.463 DFAK, DFA-KI	338 kW		01/94→			
33.463 DFAS	338 kW		01/94→			
33.463 DFC	338 kW		01/94→			
33.463 DFK, DF-KI	338 kW		01/94→			
33.463 DFS, DFRS	338 kW		01/94→			
33.464 DFAC	338 kW		05/01→			
33.464 DFAK, DFA-KI	338 kW		05/01→			
33.464 DFAS	338 kW		05/01→			
33.464 DFC	338 kW		05/01→			
33.464 DFK, DF-KI	338 kW		05/01→			
33.464 DFS, DFRS	338 kW		05/01→			
35.314 VF-TM	228 kW		03/02→			
35.364 VF, VFC, VFRC	265 kW		05/01→			
35.364 VFK, VF-HK, VF-KI	265 kW		03/02→			
35.364 VF-TM	265 kW		03/02→			
35.373 VF, VFC, VFRC	272 kW		05/01→			
35.373 VFK, VF-HK, VF-KI	272 kW		03/02→			
35.414 VF, VFC, VFRC	301 kW		05/01→			
35.414 VFK, VF-HK, VF-KI	301 kW		03/02→			
35.414 VF-TM	301 kW		03/02→			
35.423 VF, VFC	309 kW		05/01→			
35.423 VFK, VF-HK, VF-KI	309 kW		03/02→			
35.463 VF, VFC, VFRC	338 kW		08/95→			
35.463 VFK, VF-HK, VF-KI	338 kW		08/95→			
35.464 VF, VFC, VFRC	338 kW		05/01→			
35.464 VFK, VF-HK, VF-KI	338 kW		03/02→			
35.464 VF-TM	338 kW		03/02→			
40.373 DFAK	272 kW		05/01→			
40.373 DFK	272 kW		05/01→			
40.414 DFAK	301 kW		05/01→			
40.414 DFK	301 kW		05/01→			
40.423 DFAK	309 kW		05/01→			
40.423 DFK	309 kW		05/01→			
41.364 VF, VFC, VFRC	265 kW		05/01→			
41.364 VFK, VF-HK, VF-KI	265 kW		03/02→			
41.373 VF, VFC, VFRC	272 kW		05/01→			
41.373 VFK, VF-HK, VF-KI	272 kW		03/02→			

Manufacturer - Model	Power	Displ.	Year of Constr.	Remark	Part Number	Page
MAN - F 2000						01/94→
41.414 VF, VFC, VFRC	301 kW		05/01→	Depth [mm]: 64; L 652 mm; Vers. produced by BEHR; W 732 mm	8ML 376 723-751 Intercooler, charger	593
41.414 VFK, VF-HK, VF-KI	301 kW		03/02→			
41.423 VF, VFC, VFRC	309 kW		05/01→			
41.423 VFK, VF-HK, VF-KI	309 kW		03/02→			
41.463 VF, VFC, VFRC	338 kW		08/95→			
41.463 VFK, VF-HK, VF-KI	338 kW		08/95→			
41.464 VF, VFC, VFRC	338 kW		06/98→			
41.464 VFK, VF-HK, VF-KI	338 kW		03/02→			
19.403 FAC	294 kW		01/94→	Depth [mm]: 66; L 652 mm; Vers. produced by BEHR; W 612 mm	8ML 376 723-741 Intercooler, charger	593
19.403 FAK, FA-KI	294 kW		01/94→			
19.403 FAS	294 kW		01/94→	Depth [mm]: 64; L 652 mm; Vers. produced by BEHR; W 732 mm	8ML 376 723-751 Intercooler, charger	593
19.403 FC, FLC, FLLC, FRC, FLRC, F-NL	294 kW		01/94→			
19.403 FK, FLK, F-KI, FL-KI	294 kW		01/94→	Depth [mm]: 64; L 652 mm; Vers. produced by BEHR; W 612 mm	8MY 376 744-371 Radiator Core, intercooler	599
19.403 FS, FLS, FLLS, FRS, FLRS, FLLRS	294 kW		01/94→			
23.403 FNLLC	294 kW		01/94→			
24.403 FNLLC	294 kW		01/94→			
26.403 DFC,26.403 DFLLC	294 kW		01/94→			
26.403 DFK,26.403 DFLK	294 kW		01/94→			
26.403 DFS,26.403 DFSL	294 kW		01/94→			
26.403 FNLC,26.403 FNLLC, 26.403 FVLC	294 kW		01/94→			
26.403 FNLS,26.403 FVLS	294 kW		01/94→			
27.403 DFAC	294 kW		01/94→			
27.403 DFAK, DFA-KI	294 kW		01/94→			
27.403 DFAS	294 kW		01/94→			
27.403 DFC	294 kW		01/94→			
27.403 DFK, DF-KI	294 kW		01/94→			
27.403 DFS	294 kW		01/94→			
27.403 DF-TM	294 kW		07/00→			
32.403 VFC	294 kW		08/95→			
32.403 VFK	294 kW		08/95→			
33.403 DFAC	294 kW		01/94→			
33.403 DFAK, DFA-KI	294 kW		01/94→			
33.403 DFAS	294 kW		01/94→			
33.403 DFC	294 kW		01/94→			
33.403 DFK, DF-KI	294 kW		01/94→			
33.403 DFS, DFSL	294 kW		01/94→			
35.403 VF, VFC, VFRC	294 kW		08/95→			
35.403 VFK, VF-HK, VF-KI	294 kW		03/02→			
40.403 DFAK	294 kW		01/94→			
40.403 DFK	294 kW		01/94→			
41.403 VF, VFC, VFRC	294 kW		08/95→			
41.403 VFK, VF-HK, VF-KI	294 kW		08/95→			
19.603 FLS, 19604 FLS	441 kW		04/96→	Depth [mm]: 64; L 652 mm; Vers. produced by BEHR; W 732 mm	8ML 376 723-751 Intercooler, charger	593
26.373 DFC,26.373 DFLLC	272 kW		01/94→12/95			
26.373 DFK,26.373 DFLK	272 kW		01/94→12/95	Depth [mm]: 50; L 652 mm; Vers. produced by BEHR; W 612 mm	8ML 376 724-201 Intercooler, charger	594
26.373 DFS,26.373 DFSL	272 kW		01/94→12/95			
26.373 FNLC,26.373 FNLLC, 26.373 FVLC	272 kW		01/94→12/95			
26.373 FNLS,26.373 FVLS	272 kW		01/94→12/95			
26.603 DFC, DFLLC	441 kW		06/96→			
26.603 DFK, DFLK	441 kW		06/96→			
26.603 DFS, DFSL	441 kW		06/96→			
26.604 DFSL	441 kW		04/00→			
27.373 DFAC	272 kW		01/94→			
27.373 DFAK, DFA-KI	272 kW		01/94→			
27.373 DFAS	272 kW		01/94→			
27.373 DFK, DF-KI	272 kW		01/94→			
27.373 DFS	272 kW		01/94→			
27.603 DFAS	441 kW		01/96→			
27.603 DFS	441 kW		01/96→			
33.603 DFAC	441 kW		06/96→			
33.603 DFAS	441 kW		06/96→			
33.603 DFC	441 kW		06/96→			
33.603 DFS	441 kW		06/96→			
27.373 DFC	272 kW		01/94→	Depth [mm]: 64; L 652 mm; Vers. produced by BEHR; W 732 mm	8ML 376 723-751 Intercooler, charger	593
40.273 DFAK	198 kW		01/94→	Depth [mm]: 52; L 652 mm; Vers. produced by BEHR; W 612 mm	8ML 376 723-761 Intercooler, charger	593
40.273 DFK	198 kW		01/94→			
MAN - FOCL						
12.240	176 kW			Depth [mm]: 50; L 535 mm; Vers. produced by BEHR; W 712 mm	8ML 376 733-401 Intercooler, charger	598
12.250	184 kW					

Manufacturer - Model	Power	Displ.	Year of Constr.	Remark	Part Number	Page
MAN - LION S CITY						06/96→
A 20	191 kW		07/98→	Depth [mm]: 66; L 752 mm; Vers. produced by BEHR; W 612 mm	8ML 376 724-351 Intercooler, charger	595
A 21	184 kW		06/96→			
A 22	206 kW		10/09→			
A 22	235 kW		10/09→			
A 22	265 kW		10/09→			
A 23	191 kW		08/96→			
A 26	265 kW					
A 39	228 kW					
MAN - LION S COACH						09/95→
FRH 352,RH 353	257 kW		09/95→	Depth [mm]: 66; L 840 mm; Vers. produced by BEHR; W 892 mm	8ML 376 724-431 Intercooler, charger	597
FRH 402,RH 403	294 kW		09/95→			
RH 402	294 kW		09/98→			
RH 413	301 kW		01/00→			
RHC 414	301 kW		06/02→			
RH 463, RHC 464	338 kW		01/00→	04/06→ ; Depth [mm]: 64; L 931 mm; Vers. produced by BEHR; W 732 mm	8ML 376 755-461 Intercooler, charger	599
MAN - LION S STAR						01/93→
FRH 352,RH 353	257 kW		09/95→	Depth [mm]: 66; L 840 mm; Vers. produced by BEHR; W 892 mm	8ML 376 724-431 Intercooler, charger	597
FRH 402,RH 403	294 kW		09/95→			
FRH 422	309 kW		01/93→09/96			
RH 464, RHS 464	301 kW		03/00→	Depth [mm]: 66; L 840 mm; Vers. produced by BEHR; W 892 mm	8ML 376 724-431 Intercooler, charger	597
RH 464, RHS 464	301 kW		01/02→			
RH 414	338 kW		03/00→	Depth [mm]: 64; L 931 mm; Vers. produced by BEHR; W 732 mm	8ML 376 755-461 Intercooler, charger	599
RH 464, RHS 464	338 kW		01/02→			
MAN - NG						08/92→07/98
NG 262, NG 272	191 - 198 kW		08/92→07/98	Depth [mm]: 40; L 723 mm; W 617 mm	8ML 376 746-311 Intercooler, charger	598
MAN - NL						09/89→
NL 202	157 kW		09/89→04/94	Depth [mm]: 40; L 723 mm; W 617 mm	8ML 376 746-311 Intercooler, charger	598
NL 202, NL 222, NL 223	157 - 162 kW		08/92→			
NL 202, NL 262, NL 263	184 kW		04/91→			
NL 262	191 kW		06/97→			
NL 262, NL 263	191 kW		07/98→			
NL 312	228 kW		11/95→07/98			
MAN - TGA						
18.310, 18.320 FAC, FHLC	228 - 235 kW		05/04→	+ OE 81061300170/5; Vers. produced by BEHR	8ML 376 724-211 Intercooler, charger	594
18.310, 18.320 FAK, FAK-L, FALK, FALK-L, FHLK, FHLK/M	228 - 235 kW		05/04→			
18.310, 18.320 FAS, FALS, FHLS, FHLS/M	228 - 235 kW		05/04→	Depth [mm]: 66; + OE 81061300176/8; L 685 mm; Vers. produced by BEHR; W 892 mm	8ML 376 724-221 Intercooler, charger	594
18.310, 18.320 FC, FLC, FLLC, FLLC/N, FLLW, FLLW/N	228 - 235 kW		05/04→	Depth [mm]: 64; + OE 81061300216; L 665 mm; Observe technical data: 1; Vers. produced by BEHR; W 892 mm	8ML 376 724-321 Intercooler, charger	595
18.310, 18.320 FK, FK-L, FLK, FLK/M	228 - 235 kW		05/04→	Depth [mm]: 64; L 665 mm; Vers. produced by BEHR; W 892 mm	8ML 376 724-361 Intercooler, charger	595
18.310, 18.320 FLS, FLRS, FLLS, FLLRS	228 - 235 kW		05/04→	Depth [mm]: 64; L 892 mm; Vers. produced by BEHR; W 665 mm	8ML 376 724-371 Intercooler, charger	596
18.350, 18.360 FAC, FHLC	257 - 265 kW		05/04→	+ OE 81061300215; Observe technical data: 1; Vers. produced by BEHR	8ML 376 724-381 Intercooler, charger	597
18.350, 18.360 FAK, FAK-L, FALK, FALK-L, FHLK, FHLK/M	257 - 265 kW		05/04→			
18.350, 18.360 FAS, FALS, FHLS, FHLS/M	257 - 265 kW		05/04→			
18.350, 18.360 FC, FLC, FLLC, FLLRC, FLLC/N, FLLW, FLLW/N	257 - 265 kW		05/04→			
18.350, 18.360 FK, FK-L, FLK, FLK/M,	257 - 265 kW		05/04→			
18.350 FLS, FLS/N, FLS/M, FLS-TS, FLLS, FLLS/N, FLLRS	257 kW		05/04→			
18.360 FLS, FLLS, FLRS, FLLRS	265 kW		01/06→			
18.390, 18.400 FAC, FHLC	287 - 294 kW		05/04→			
18.390, 18.400 FAK, FAK-L, FALK, FALK-L, FHLK, FHLK/M	287 - 294 kW		05/04→			
18.390, 18.400 FAS, FALS, FHLS, FHLS/M	287 - 294 kW		05/04→			
18.390, 18.400 FC, FLC, FLLC, FLLC/N, FLLW, FLLW/N	287 - 294 kW		05/04→			
18.390, 18.400 FK, FK-L, FLK, FLK/M	287 - 294 kW		05/04→			
18.390 FLS, FLS-TS, FLS/M, FLLS, FLLS/N, FLLS/M, FLLRS	287 kW		05/04→			
18.400 FLS, FLLS, FLRS, FLLRS	294 kW		10/05→			
18.440 FLS, FLLS, FLRS, FLLRS	324 kW		09/05→			
18.480 FAC	353 kW		02/06→			
18.480 FAK, FALK	353 kW		02/06→			

Manufacturer - Model	Power	Displ.	Year of Constr.	Remark	Part Number	Page
MAN - TGA						04/00→
18.480 FAS, FALS	353 kW		02/06→	+ OE 81061300170/5; Vers. produced by BEHR	8ML 376 724-211 Intercooler, charger	594
18.480 FLS, FLLS, FLRS, FLLRS	353 kW		01/06→			
18.540 FLC, FLRC, FLLC, FLLRC, FLLW	397 kW		08/06→	Depth [mm]: 66; + OE 81061300176/8; L 685 mm; Vers. produced by BEHR; W 892 mm	8ML 376 724-221 Intercooler, charger	594
18.540 FLS, FLRS, FLLS, FLLRS	397 kW		08/06→			
19.350 FS, FRS, FLS, FLRS-WW	257 kW		05/04→	Depth [mm]: 64; + OE 81061300216; L 665 mm; Observe technical data: 1; Vers. produced by BEHR; W 892 mm	8ML 376 724-321 Intercooler, charger	595
19.360 FS, FRS, FLS, FLRS-WW	265 kW		05/04→			
19.390 FS, FRS, FLS, FLRS-WW	287 kW		05/04→			
19.440 FRS, FS/M-WW, FLS, FLRS	324 kW		02/06→	Depth [mm]: 64; L 665 mm; Vers. produced by BEHR; W 892 mm	8ML 376 724-361 Intercooler, charger	595
19.480 FLS, FRS, FLRS-WW	353 kW		02/06→	Depth [mm]: 64; L 892 mm; Vers. produced by BEHR; W 665 mm	8ML 376 724-371 Intercooler, charger	596
19.480 FS/M, FRS/M-WW	353 kW		02/06→			
24.350, 24.360 FNLLC, FNLLW/N, FNLLRW	257 - 265 kW		05/04→	+ OE 81061300215; Observe technical data: 1; Vers. produced by BEHR	8ML 376 724-381 Intercooler, charger	597
24.350, 24.360 FPLS, FPLRS	257 - 265 kW		02/04→			
24.390, 24.400 FNLLC/N, FNLLW/N, FNLLRC, FNLLRW	287 - 294 kW		05/04→			
24.390, 24.400 FPLS, FPLRS	287 - 294 kW		05/04→			
26.310, 26.320 FDC, FDRC, FDC/M, FDRC/M, FDLC, FNHLC, FVHLC	228 - 235 kW		05/04→			
26.310, 26.320 FDH, FDHC, FDHC/M	228 - 235 kW		06/05→			
26.310, 26.320 FDHK	228 - 235 kW		06/05→			
26.310, 26.320 FDHS, FDHS/M	228 - 235 kW		06/05→			
26.310, 26.320 FDK, FDLK	228 - 235 kW		05/04→			
26.310, 26.320 FDS, FDS/M, FDLS, FDRS, FDRS/M, FNHLS, FDLRS	228 - 235 kW		05/04→			
26.310, 26.320 FNLC, FNLLC, FNLR, FNLLRC, FNLLW	228 - 235 kW		05/04→			
26.310, 26.320 FNLS, FNLLS, FNLR, FNLLRS	228 - 235 kW		05/04→			
26.310, 26.320 FVHL-KO	228 - 235 kW		06/05→			
26.310, 26.320 FVLC	228 - 235 kW		02/04→			
26.310, 26.320 FVL-KO	228 - 235 kW		02/04→			
26.310 FDAC	228 kW		01/04→			
26.310 FDAK	228 kW		01/04→			
26.310 FDAS	228 kW		01/04→			
26.320 FDAC	235 kW		04/06→			
26.320 FDAK	235 kW		04/06→			
26.320 FDAS	235 kW		04/06→			
26.350, 26.360 FDC, FDRC, FDC/M, FDRC/M, FDLC, FDLRC, FNHLC	257 - 265 kW		05/04→			
26.350, 26.360 FDK, FDLK, FDRK	257 - 265 kW		05/04→			
26.350, 26.360 FDS, FDS/M, FDLS, FDRS, FNHLS, FPHLS	257 - 265 kW		05/04→			
26.350, 26.360 FNLC, FNLLC, FNLLW, FNLR, FNLLRC	257 - 265 kW		05/04→			
26.350, 26.360 FNLS, FNLLS, FNLR, FNLLRS, FPLS, FPLRS	257 - 265 kW		05/04→			
26.350, 26.360 FVHL-KO	257 - 265 kW		06/05→			
26.350, 26.360 FVL-KO	257 - 265 kW		01/04→			
26.350 FDAC	257 kW		02/04→			
26.350 FDAK	257 kW		02/04→			
26.350 FDAS	257 kW		02/04→			
26.350 FDHC, FDHC/M	257 kW		04/05→			
26.350 FDLRC-WW	257 kW		05/04→			
26.350 FDLS, FDLRS, FDLRS/M, FDLRS-WW	257 kW		05/04→			
26.350 FVHLC	257 kW		06/05→			
26.350 FVHLS	257 kW		07/05→			
26.350 FVLC	257 kW		01/04→			
26.350 FVLS, FVLRS	257 kW		07/05→			
26.360 FDAC, FDARC	265 kW		06/04→			
26.360 FDAK, FDARK	265 kW		06/04→			
26.360 FDAS, FDARS	265 kW		06/04→			
26.360 FDHC, FDHLC	265 kW		05/04→			
26.360 FDLC-WW, FDLRC	265 kW		05/04→			
26.360 FDLS, FDLRS-WW, FNHLS	265 kW		05/04→			
26.360 FVHLC	265 kW		04/06→			
26.360 FVHLS	265 kW		04/06→			
26.360 FVLC	265 kW		04/06→			
26.360 FVLS, FVLRS	265 kW		04/06→			
26.390, 26.400 FDC, FDRC, FDLRC, FDRC/M, FDLC, FNHLC, FVHLC	287 - 294 kW		05/04→			
26.390, 26.400 FDK, FDLK	287 - 294 kW		05/04→			

Manufacturer - Model	Power	Displ.	Year of Constr.	Remark	Part Number	Page
MAN - TGA						04/00→
26.390, 26.400 FDS, FDS/M, FDLS, FDLRS, FNHLS, FPHLS, FVHLS	287 - 294 kW		05/04→	+ OE 81061300170/5; Vers. produced by BEHR	8ML 376 724-211 Intercooler, charger	594
26.390, 26.400 FNLC, FNLLC, FNLLW, FNLR, FNLLRC	287 - 294 kW		05/04→	Depth [mm]: 66; + OE 81061300176/8; L 685 mm; Vers. produced by BEHR; W 892 mm	8ML 376 724-221 Intercooler, charger	594
26.390, 26.400 FNLS, FNLLS, FNLR, FNLLRS, FPLS, FPLRS	287 - 294 kW		05/04→	Depth [mm]: 64; + OE 81061300216; L 665 mm; Observe technical data: 1; Vers. produced by BEHR; W 892 mm	8ML 376 724-321 Intercooler, charger	595
26.390, 26.400 FVHL-KO	287 - 294 kW		06/05→	Depth [mm]: 64; L 665 mm; Vers. produced by BEHR; W 892 mm	8ML 376 724-361 Intercooler, charger	595
26.390, 26.400 FVL-KO	287 - 294 kW		02/04→			
26.390 FDAC, FDALC	287 kW		01/04→			
26.390 FDAK, FDALK	287 kW		02/04→			
26.390 FDAS, FDALS	287 kW		02/04→			
26.390 FDH-TM	287 kW		06/05→			
26.390 FVLC	287 kW		02/04→			
26.390 FVLS, FVLRS	287 kW		07/05→			
26.400 FDAC, FDALC	294 kW		01/04→			
26.400 FDAK, FDALK	294 kW		01/04→			
26.400 FDAS, FDALS	294 kW		01/04→			
26.400 FDH-TM	294 kW		04/06→			
26.400 FVLC	294 kW		04/06→			
26.400 FVLS, FVLRS	294 kW		04/06→			
26.440 FDAC, FDALC	324 kW		09/05→			
26.440 FDAK, FDALK	324 kW		01/04→			
26.440 FDAS, FDALS	324 kW		01/04→			
26.440 FDLC-WW, FDLRC-WW	324 kW		02/06→			
26.440 FDS, FDLS, FDLRS-WW, FDLRS-WW	324 kW		02/06→			
26.440 FVL-KO	324 kW		09/05→			
26.440 FVLS, FVLRS	324 kW		09/05→			
26.480 FDAC, FDALC	353 kW		02/06→			
26.480 FDAK, FDALK	353 kW		02/06→			
26.480 FDAS, FDALS	353 kW		02/06→			
26.480 FVL-KO	353 kW		01/06→			
26.540 FNLC, FNLLC, FNLLRC, FNLLW	397 kW		08/06→			
28.310 FNLC, FNLLC, FNLR	228 kW		09/02→			
28.310 FNLS, FNLR	228 kW		06/04→			
28.320 FNLC, FNLLC, FNLR	235 kW		06/04→			
28.320 FNLS, FNLR	235 kW		06/04→			
28.350 FANLC	257 kW		07/06→			
28.350 FANLK	257 kW		07/06→			
28.350 FNLS, FNLR-WW	257 kW		02/04→			
28.360 FANLC	265 kW		07/06→			
28.360 FANLK	265 kW		07/06→			
28.360 FNLS, FNLR-WW	265 kW		04/06→			
28.390 FANLC	287 kW		07/06→			
28.390 FANLK	287 kW		07/06→			
28.390 FNLS, FNLR	287 kW		05/04→			
28.400 FANLC	294 kW		07/06→			
28.400 FANLK	294 kW		07/06→			
28.400 FNLS, FNLR	294 kW		04/06→			
28.440 FANLC	324 kW		07/06→			
28.440 FANLK	324 kW		07/06→			
28.440 FNLS, FNLR-WW	324 kW		09/05→			
28.480 FANLC	353 kW		07/06→			
28.480 FANLK	353 kW		07/06→			
28.480 FNLC, FNLR-WW, FNLLC	353 kW		02/06→			
28.480 FNLS, FNLR-WW	353 kW		02/06→			
28.540 FNLC, FNLLC	397 kW		08/06→			
28.540 FNLS	397 kW		08/06→			
32.350, 32.360 FFDRC	257 - 265 kW		05/04→			
32.350, 32.360 FFD-TM, FFDR-TM	257 - 265 kW		02/04→			
32.390, 32.400 FFDRC	287 - 294 kW		05/04→			
32.390, 32.400 FFD-TM, FFDR-TM	287 - 294 kW		05/04→			
33.350 FDC-TM, FDRC-TM	257 kW		09/07→			
33.360 FDC-TM, FDRC-TM	265 kW		09/07→			
33.440 FDAC, FDHC	324 kW		06/05→			
33.440 FDAK, FDHK	324 kW		06/05→			
33.440 FDAS, FDHS	324 kW		06/05→			
33.440 FDC, FDRC	324 kW		06/05→			
33.440 FDC-TM, FDRC-TM	324 kW		09/07→			
33.440 FDK, FDRK	324 kW		06/05→			
33.440 FDS, FDRS	324 kW		06/05→			
33.480 FDC-TM, FDRC-TM	353 kW		09/07→			
35.310, 35.320 FFDLC	228 - 235 kW		02/04→			
35.310, 35.320 FFDK, FFDLK	228 - 235 kW		02/04→			
35.310, 35.320 FFD-TM	228 - 235 kW		02/04→			

Manufacturer - Model	Power	Displ.	Year of Constr.	Remark	Part Number	Page
MAN - TGA						04/00→
35.350, 35.360 FFDC, FFDRC, FFDLC	257 - 265 kW		02/04→	+ OE 81061300170/5; Vers. produced by BEHR	8ML 376 724-211 Intercooler, charger	594
35.350, 35.360 FFDK, FFDRC, FFDLK	257 - 265 kW		02/04→	Depth [mm]: 66; + OE 81061300176/8; L 685 mm; Vers. produced by BEHR; W 892 mm	8ML 376 724-221 Intercooler, charger	594
35.350, 35.360 FFD-TM	257 - 265 kW		02/04→			
35.350 FFDHK, FFDHLK	257 kW		07/06→			
35.350 FFDH-TM	257 kW		07/06→	Depth [mm]: 64; + OE 81061300216; L 665 mm; Observe technical data: 1; Vers. produced by BEHR; W 892 mm	8ML 376 724-321 Intercooler, charger	595
35.350 FFNLC	257 kW		07/06→			
35.360 FFDHK, FFDHLK	265 kW		07/06→	Depth [mm]: 64; L 665 mm; Vers. produced by BEHR; W 892 mm	8ML 376 724-361 Intercooler, charger	595
35.360 FFDH-TM	265 kW		07/06→			
35.360 FFNHLC	265 kW		07/06→	Depth [mm]: 64; L 892 mm; Vers. produced by BEHR; W 665 mm	8ML 376 724-371 Intercooler, charger	596
35.360 FFNLC	265 kW		07/06→			
35.390, 35.400 FFDC, FFDRC, FFDLC	287 - 294 kW		02/04→	+ OE 81061300215; Observe technical data: 1; Vers. produced by BEHR	8ML 376 724-381 Intercooler, charger	597
35.390, 35.400 FFDK, FFDRC, FFDLK	287 - 294 kW		02/04→			
35.390, 35.400 FFD-TM	287 - 294 kW		02/04→			
35.390 FDNLC	287 kW		07/06→			
35.390 FFDAK	287 kW		02/04→			
35.390 FFDAK, FFDHK, FFDHLK	287 kW		07/06→			
35.390 FFDH-TM	287 kW		07/06→			
35.400 FDNLC	294 kW		07/06→			
35.400 FFDAK	294 kW		02/04→			
35.400 FFDAK, FFDHK, FFDHLK	294 kW		07/06→			
35.400 FFDH-TM	294 kW		07/06→			
35.400 FFNHLC	294 kW		11/06→			
35.400 FFNLC	294 kW		07/06→			
35.440 FDNLC	324 kW		07/06→			
35.440 FFDAK, FFDHK, FFDHLK	324 kW		07/06→			
35.440 FFDH-TM	324 kW		07/06→			
35.440 FFNHLC	324 kW		11/06→			
35.440 FFNLC	324 kW		07/06→			
35.480 FDNLC	353 kW		07/06→			
35.480 FFDAK	353 kW		07/06→			
35.480 FFDAK, FFDHK, FFDHLK	353 kW		07/06→			
35.480 FFDH-TM	353 kW		07/06→			
35.480 FFNHLC	353 kW		11/06→			
35.480 FFNLC	353 kW		07/06→			
37.310, 37.320 FFDC	228 - 235 kW		12/04→			
37.310, 37.320 FFDK	228 - 235 kW		12/04→			
37.310, 37.320 FFD-TM	228 - 235 kW		12/04→			
37.350, 37.360 FFDC	257 - 265 kW		12/04→			
37.350, 37.360 FFDK	257 - 265 kW		12/04→			
37.350, 37.360 FFD-TM	257 - 265 kW		12/04→			
37.390, 37.400 FFDC	287 - 294 kW		12/04→			
37.390, 37.400 FFDK	287 - 294 kW		12/04→			
37.390, 37.400 FFD-TM	287 - 294 kW		12/04→			
39.390 FVNLC	287 kW		07/06→			
39.400 FVNLC	294 kW		07/06→			
39.440 FVNLC	324 kW		07/06→			
39.480 FVNLC	353 kW		07/06→			
40.440 FDAK-WW	324 kW		06/05→			
40.440 FDAS-WW	324 kW		06/05→			
40.440 FDK-WW, FDRK	324 kW		06/05→			
40.440 FDS-WW, FDRS	324 kW		06/05→			
40.480 FDK-WW, FDRK	353 kW		06/05→			
40.480 FDS-WW; FDRS	353 kW		06/05→			
41.350, 41.360 FFDC, FFDRC/M, FFDRC	257 - 265 kW		12/04→			
41.350, 41.360 FFDK, FFDRC	257 - 265 kW		12/04→			
41.350, 41.360 FFD-TM	257 - 265 kW		12/04→			
41.350 FFDC-TM, FFDRC-TM	257 kW		09/07→			
41.360 FFD	265 kW		12/08→			
41.360 FFDC-TM, FDRC-TM	265 kW		09/07→			
41.390, 41.400 FFDC, FFDRC, FFDRC/M	287 - 294 kW		12/04→			
41.390, 41.400 FFDK, FFDRC	287 - 294 kW		12/04→			
41.390, 41.400 FFD-TM	287 - 294 kW		12/04→			
41.390 FFDAK	287 kW		12/04→			
41.390 FFDC-TM, FDRC-TM	287 kW		09/07→			
41.430 FFDAK	316 kW		07/06→			
41.440 FFD/M	324 kW		12/04→			
41.440 FFDAK	324 kW		07/06→			
41.440 FFDC, FFDRC	324 kW		12/04→			
41.440 FFDC-TM, FFDRC-TM	324 kW		09/07→			
41.440 FFDK, FFDRC	324 kW		12/04→			
41.480 FFD	353 kW		12/08→			
41.480 FFDAK	353 kW		07/06→			
41.480 FFDC-TM, FFDRC-TM	353 kW		09/07→			
41.540 FVDS, FVDLS	397 kW		11/06→			

Manufacturer - Model	Power	Displ.	Year of Constr.	Remark	Part Number	Page
MAN - TGA						04/00→
18.310, 18320 FC, FLC, FRC, FLLC, FLLC/N, FLLW, FLLRC, FLLRW	228 - 235 kW		04/00→	+ OE 81061300170/5; Vers. produced by BEHR	8ML 376 724-211 Intercooler, charger	594
18.310, 18320 FK, FLK, FK-L, FLRK	228 - 235 kW		12/00→	Depth [mm]: 66; + OE 81061300176/8; L 685 mm; Vers. produced by BEHR; W 892 mm	8ML 376 724-221 Intercooler, charger	594
18.310 FAK, FAK-L, FALK	228 kW		09/02→	Depth [mm]: 64; + OE 81061300216; L 665 mm; Observe technical data: 1; Vers. produced by BEHR; W 892 mm	8ML 376 724-321 Intercooler, charger	595
18.310 FAS, FARS	228 kW		09/02→			
18.310 FLS, FLLS, FLLS/N, FLS-TS, FLRS, FLLRS	228 kW		04/00→	Depth [mm]: 64; L 892 mm; Vers. produced by BEHR; W 665 mm	8ML 376 724-371 Intercooler, charger	596
18.360 FAC, FARC	265 kW		09/02→	+ OE 81061300215; Observe technical data: 1; Vers. produced by BEHR	8ML 376 724-381 Intercooler, charger	597
18.360 FAK, FALK, FAK-L, FALK-L	265 kW		09/02→			
18.360 FAS, FALS, FARS	265 kW		09/02→			
18.360 FC, FLC, FRC, FLLC, FLLC/N, FLLW, FLLRW	265 kW		04/00→			
18.360 FK, FLK, FK-L, FLRK	265 kW		12/00→			
18.360 FLS, FLLS, FLLS/N, FLS-TS, FLRS, FLLRS	265 kW		04/00→			
18.410, 18420 FAK, FAK-L, FALK	301 - 309 kW		09/02→			
18.410, 18420 FC, FRC, FLC, FLRC, FLLC, FLLC/N, FLLW, FLLRC	301 - 309 kW		04/00→			
18.410, 18420 FK, FK-L, FLK, FLRK	301 - 309 kW		12/00→			
18.410 FAC, FARC	301 kW		09/02→			
18.410 FAS, FALS, FARS	301 kW		09/02→			
18.410 FLS, FLLS, FLLS/N, FLS-TS, FLRS, FLLRS	301 kW		04/00→			
18.460 FC, FLC, FRC, FLLC, FLLC/N, FLLW, FLLRC, FLLRW	338 kW		04/00→			
18.460 FK, FK-L, FLK, FLRK	338 kW		12/00→			
18.460 FLS, FLLS, FLLS/N, FLS-TS, FLRS, FLLRS	338 kW		04/00→			
18.480 FAC, FARC	353 kW		09/02→			
18.480 FAK, FAK-L, FALK	353 kW		09/02→			
18.480 FAS, FALS, FARS	353 kW		09/02→			
18.480 FC, FLC, FLLC, FLLRC, FLLW, FLRC	353 kW		01/06→			
18.480 FC, FLC, FLLC, FLLW, FLLRW, FLLRC	353 kW		09/02→			
18.480 FHLK	353 kW		04/06→			
18.480 FHLK, FHLK/M	353 kW		04/06→			
18.480 FK, FLK, FK-L	353 kW		09/02→			
18.480 FLS, FLLS, FLLS/N, FLS-TS, FLRS-WW	353 kW		09/02→			
18.510 FC, FLC, FRC, FLLC, FLLC/N, FLLW, FLLRC, FLLRW	375 kW		09/00→			
18.510 FLS, FLLS, FLLS/N, FLRS, FLLRS	375 kW		04/00→			
18.530 FAC	390 kW		04/04→			
18.530 FAK, FALK	390 kW		04/04→			
18.530 FAS, FALS	390 kW		04/04→			
18.530 FC, FLC, FLLC, FLLC/N, FLLW, FLLRC, FLLRW	390 kW		09/02→			
18.530 FLS, FLLS, FLLS/N	390 kW		09/02→			
19.360 FS/M-WW, FRS/M-WW	265 kW		05/04→			
19.410 FS/M-WW, FRS/M-WW	301 kW		05/04→			
19.460 FS/M-WW, FRS/M-WW	338 kW		05/04→			
19.480 FS/M-WW, FRS/M-WW	353 kW		05/04→			
24.360 FNLLC/N, FNLLW, FNLLRW, FNLLRC	265 kW		09/01→			
24.410 FNLLC/N, FNLLW, FNLLRW	301 kW		09/01→			
24.460 FNLLC/N, FNLLW, FNLLRC, FNLLRW	338 kW		09/01→			
24.480 FNLLC/N, FNLLW, FNLLRC, FNLLRW	353 kW		09/02→			
24.480 FPLS, FPLRS	353 kW		07/05→			
24.510 FNLLC/N, FNLLW, FNLLRW	375 kW		09/01→			
24.530 FNLLC/N, FNLLW, FNLLRW	390 kW		09/01→			
24.530 FPLS, FPLRS	390 kW		07/05→			
26.280 FNLC, FNLLC, FNLLW	206 kW		11/02→			
26.310, 26.320 FDH-TM	228 - 235 kW		06/05→			
26.310, 26.320 FD-TM	228 - 235 kW		06/05→			
26.310 FDAC, FDARC	228 kW		02/02→			
26.310 FDAK	228 kW		02/02→			
26.310 FDAS, FDARS	228 kW		02/02→			
26.310 FDC, FDLC, FDRC, FDLC/M, FDLRC	228 kW		01/01→			

Manufacturer - Model	Power	Displ.	Year of Constr.	Remark	Part Number	Page
MAN - TGA						04/00→
26.310 FDK, FDLK, FDRK	228 kW		09/02→	+ OE 81061300170/5; Vers. produced by BEHR	8ML 376 724-211 Intercooler, charger	594
26.310 FDS, FDLS, FDLS/M, FDLRS	228 kW		01/01→			
26.310 FD-TM, FDR-TM	228 kW		10/00→	Depth [mm]: 66; + OE 81061300176/8; L 685 mm; Vers. produced by BEHR; W 892 mm	8ML 376 724-221 Intercooler, charger	594
26.310 FNLC, FNLLC, FVLC, FNLLW, FNLR, FNLLRW	228 kW		09/00→			
26.310 FPLS, FVLS, FNLS, FNLLS, FPLRS, FNLRS, FVLRS	228 kW		12/00→	Depth [mm]: 64; + OE 81061300216; L 665 mm; Observe technical data: 1; Vers. produced by BEHR; W 892 mm	8ML 376 724-321 Intercooler, charger	595
26.310 FVLC	228 kW		09/03→			
26.310 FVL-KO	228 kW		12/00→	Depth [mm]: 64; L 892 mm; Vers. produced by BEHR; W 665 mm	8ML 376 724-371 Intercooler, charger	596
26.330 FNLC, FNLLC, FNLLW	240 kW		11/02→			
26.350, 26.360 FDHK, FDHLK	257 - 265 kW		05/04→	+ OE 81061300215; Observe technical data: 1; Vers. produced by BEHR	8ML 376 724-381 Intercooler, charger	597
26.350, 26.360 FDHS, FDHS/M, FDHLS	257 - 265 kW		05/04→			
26.350, 26.360 FDH-TM	257 - 265 kW		05/04→			
26.350, 26.360 FD-TM	257 - 265 kW		02/04→			
26.360 FDAC, FDARC	265 kW		02/02→			
26.360 FDAK, FDALK	265 kW		02/02→			
26.360 FDAS, FDARS	265 kW		02/02→			
26.360 FDC, FDLC, FDLC/M, FDR, FDLRC-WW	265 kW		01/01→			
26.360 FDK, FDLK, FDRK, FDLRK	265 kW		09/02→			
26.360 FDLS, FDLS/M, FDLRS, FDLRS/M, FDLRS-WW, FDRS	265 kW		09/03→			
26.360 FDS, FDLS, FNLS, FNLLS, FPLS, FPLRS, FVLS, FVLRS	265 kW		12/00→			
26.360 FD-TM, FDR-TM	265 kW		01/01→			
26.360 FNLC, FNLLC, FNLLW, FNLLRC, FNLLRW, FVLC	265 kW		09/00→			
26.360 FVL-KO	265 kW		12/00→			
26.390, 26.400 FDHC, FDHC/M, FDHLC	287 - 294 kW		06/05→			
26.390, 26.400 FDHK, FDHLK	287 - 294 kW		06/05→			
26.390, 26.400 FDHS, FDHS/M, FDHLS	287 - 294 kW		06/05→			
26.390, 26.400 FD-TM	287 - 294 kW		05/04→			
26.410 FDAC, FDARC	301 kW		02/02→			
26.410 FDAK, FDALK	301 kW		02/02→			
26.410 FDAS, FDALS, FDARS	301 kW		02/02→			
26.410 FDC, FDLC, FDLC/M, FDLC-WW; FDR-WW, FDLRC-WW	301 kW		01/01→			
26.410 FDK, FDRK, FDLK, FDLRK	301 kW		09/01→			
26.410 FDS, FDLS, FDLS/M, FDLS-WW, FDRS-WW, FDLRS-WW	301 kW		06/01→			
26.410 FD-TM, FDR-TM	301 kW		01/01→			
26.410 FNLC, FNLLC, FNLLW, FNLR, FNLLRC, FVLC	301 kW		04/00→			
26.410 FPLS, FPLRS, FVLS, FNLS, FNLLS	301 kW		12/00→			
26.410 FVLC	301 kW		09/03→			
26.410 FVL-KO	301 kW		12/00→			
26.410 FVLS, FVLRS	301 kW		07/05→			
26.460 FDC, FDLC, FDLC/M, FDLC-WW, FDR, FDLRC-WW	338 kW		01/01→			
26.460 FDK, FDLK, FDLRK	338 kW		01/01→			
26.460 FDS, FDLS, FDLS/M, FDLS-WW, FDRS-WW, FDLRS-WW	338 kW		06/01→			
26.460 FD-TM, FDR-TM	338 kW		01/01→			
26.460 FNLC, FNLR, FNLLC, FNLLRW, FNLLRC	338 kW		04/00→			
26.460 FPLS, FPLRS, FVLS, FVLRS, FNLS, FNLLS, FNLRS	338 kW		12/00→			
26.460 FVLC	338 kW		02/01→			
26.460 FVL-KO	338 kW		12/00→			
26.480 FDAC, FDALC, FDARC	353 kW		09/02→			
26.480 FDAK, FDALK	353 kW		09/02→			
26.480 FDAS, FDALS, FDARS	353 kW		09/02→			
26.480 FDC, FDC/M, FDLC, FDLRC, FDR, FNHLC, FVHLC, FDLRC-WW	353 kW		02/06→			
26.480 FDC, FDLC, FDR, FDLC/M, FDLRC-WW	353 kW		09/02→			
26.480 FDHK, FDHLK	353 kW		02/06→			
26.480 FDK, FDLK, FDLRK	353 kW		09/02→			

Manufacturer - Model	Power	Displ.	Year of Constr.	Remark	Part Number	Page
MAN - TGA						04/00→
26.480 FDS, FDLS, FDLRS, FNHLS, FPHLS, FVHLS	353 kW		02/06→	+ OE 81061300170/5; Vers. produced by BEHR	8ML 376 724-211 Intercooler, charger	594
26.480 FDS, FDLS, FDLS/M, FDLRS-WW, FDRS	353 kW		09/02→	Depth [mm]: 66; + OE 81061300176/8; L 685 mm; Vers. produced by BEHR; W 892 mm	8ML 376 724-221 Intercooler, charger	594
26.480 FD-TM	353 kW		09/02→			
26.480 FNLC, FNLLC, FVLC, FNLLRC, FVLLW	353 kW		09/02→	Depth [mm]: 64; + OE 81061300216; L 665 mm; Observe technical data: 1; Vers. produced by BEHR; W 892 mm	8ML 376 724-321 Intercooler, charger	595
26.480 FNLS, FNLLS, FNLRs, FPLS, FVLS	353 kW		09/02→	Depth [mm]: 64; L 892 mm; Vers. produced by BEHR; W 665 mm	8ML 376 724-371 Intercooler, charger	596
26.480 FVL-KO	353 kW		09/02→			
26.510 FDC, FDC/M, FDRC, FDLC, FDLC/M, FDLRC	375 kW		01/01→	+ OE 81061300215; Observe technical data: 1; Vers. produced by BEHR	8ML 376 724-381 Intercooler, charger	597
26.510 FDS, FDLS, FDLS/M, FDRS, FDLRS	375 kW		01/01→			
26.510 FNLC, FNLLC, FNLLW, FNLLRC, FVLC	375 kW		12/00→			
26.510 FNLS, FNLLS, FNLRs, FPLS, FVLS	375 kW		12/00→			
26.530 FDAC, FDALC	390 kW		07/06→			
26.530 FDAK, FDALK	390 kW		09/02→			
26.530 FDAS, FDALS	390 kW		07/06→			
26.530 FDC, FDLC, FDC/M, FDLRC	390 kW		01/01→			
26.530 FDK, FDLK, FDLRK	390 kW		09/02→			
26.530 FDS, FDLS, FDLS/M, FDLRS	390 kW		01/01→			
26.530 FNLC, FNLLC, FNLLW, FNLLRC, FVLC, FVLR	390 kW		09/02→			
26.530 FNLS, FNLLS, FNLRs, FPLS, FVLS, FVLRs	390 kW		09/02→			
28.310, 28.320 FNLC, FNLLC, FNLL-LE, FNLLR-LE	228 - 235 kW		07/06→			
28.310, 28.320 FNLC, FNLLC, FNLLRC, FNLLR-LE	228 - 235 kW		07/06→			
28.310 FNLC, FNLLC	228 kW		09/02→			
28.310 FNLS, FNLRs	228 kW		09/02→			
28.350, 28.360 FNLC, FNLLC, FNLL-LE	257 - 265 kW		07/06→			
28.350, 28.360 FNLC, FNLLC, FNLR, FNLL-LE	257 - 265 kW		06/04→			
28.360 FNLC, FNLLC	265 kW		09/02→			
28.360 FNLS, FNLRs	265 kW		09/02→			
28.390, 28.400 FNLC, FNLLC, FNLR, FNLL-LE	287 - 294 kW		06/04→			
28.390 FNLLC	353 kW		07/06→			
28.410 FANLC	301 kW		07/06→			
28.410 FANLK	301 kW		07/06→			
28.410 FNLC, FNLLC	301 kW		09/02→			
28.410 FNLC, FNLLC, FNLR	301 kW		09/02→			
28.410 FNLS, FNLRs	301 kW		09/02→			
28.460 FNLC, FNLLC, FNLR	338 kW		09/02→			
28.460 FNLS, FNLRs	338 kW		09/02→			
28.480 FNLC, FNLLC, FNLR	353 kW		09/02→			
28.480 FNLS, FNLRs	353 kW		09/02→			
28.510 FNLC, FNLLC, FNLR	375 kW		09/02→			
28.510 FNLS, FNLRs	375 kW		09/02→			
28.530 FANLC	390 kW		07/06→			
28.530 FANLK	390 kW		07/06→			
28.530 FNLC, FNLLC, FNLR	390 kW		09/02→			
28.530 FNLS, FNLRs	390 kW		09/02→			
32.310 FFDLC, FFDLC, FFDLRC	228 kW		01/02→			
32.310 FFDK, FFDLK	228 kW		01/02→			
32.310 FFD-TM	228 kW		01/02→			
32.360 FFDLC, FFDLC, FFDLRC	265 kW		01/02→			
32.360 FFDK, FFDLK	265 kW		01/02→			
32.360 FFD-TM	265 kW		01/02→			
32.410 FFDLC, FFDLC, FFDRC, FFDLRC	301 kW		01/02→			
32.410 FFDK, FFDLK	301 kW		01/02→			
32.410 FFD-TM	301 kW		01/02→			
32.460 FFDLC, FFDLC, FFDLRC	338 kW		01/02→			
32.460 FFDK, FFDLK	338 kW		01/02→			
32.460 FFD-TM	338 kW		01/02→			
32.480 FFDLC, FFDLC, FFDLRC	353 kW		09/02→			
32.480 FFDK, FFDLK	353 kW		09/02→			
32.480 FFD-TM	353 kW		09/02→			
33.350, 33.360 FDAC, FDHC, FDHC/M	257 - 265 kW		06/05→			
33.350, 33.360 FDAK, FDHK	257 - 265 kW		06/05→			
33.350, 33.360 FDAS, FDHS, FDHS/M	257 - 265 kW		06/05→			

Manufacturer - Model	Power	Displ.	Year of Constr.	Remark	Part Number	Page
MAN - TGA						04/00→
33.350, 33.360 FDC, FDC/M, FDLK, FDRK	257 - 265 kW		05/04→	+ OE 81061300170/5; Vers. produced by BEHR	8ML 376 724-211 Intercooler, charger	594
33.350, 33.360 FDK, FDLK, FDRK	257 - 265 kW		05/04→	Depth [mm]: 66; + OE 81061300176/8; L 685 mm; Vers. produced by BEHR; W 892 mm	8ML 376 724-221 Intercooler, charger	594
33.350, 33.360 FDS, FDLK, FDRK	257 - 265 kW		05/04→	Depth [mm]: 64; + OE 81061300216; L 665 mm; Observe technical data: 1; Vers. produced by BEHR; W 892 mm	8ML 376 724-321 Intercooler, charger	595
33.360 FDAC, FDARC, FDAC-WW	265 kW		09/02→	Depth [mm]: 64; L 892 mm; Vers. produced by BEHR; W 665 mm	8ML 376 724-371 Intercooler, charger	596
33.360 FDAK, FDAK-WW	265 kW		09/02→	+ OE 81061300215; Observe technical data: 1; Vers. produced by BEHR	8ML 376 724-381 Intercooler, charger	597
33.360 FDAS, FDAS-WW	265 kW		09/02→			
33.360 FDC, FDC-WW, FDLK/M, FDLRC	265 kW		10/00→			
33.360 FDK, FDK-WW, FDLK, FDRK-WW	265 kW		01/01→			
33.360 FDS, FDS-WW, FDLK, FDLRS, FDRS-WW	265 kW		10/00→			
33.360 FD-TM, FDR-TM	265 kW		01/01→			
33.390, 33.400 FDAC, FDHC, FDHC/M	287 - 295 kW		06/05→			
33.390, 33.400 FDAK, FDHK	287 - 295 kW		06/05→			
33.390, 33.400 FDAS, FDHS, FDHS/M	287 - 295 kW		06/05→			
33.390, 33.400 FDC, FDLK, FDLRC	287 - 294 kW		05/04→			
33.390, 33.400 FDC-TM, FDR-TM	287 - 294 kW		09/07→			
33.390, 33.400 FDK, FDLK, FDRK	287 - 294 kW		05/04→			
33.390, 33.400 FDS, FDLK, FDLRS, FDRS, FDS/M	287 - 294 kW		05/04→			
33.410 FDAC, FDAC-WW, FDALC	301 kW		09/02→			
33.410 FDAK, FDAK-WW, FDALK	301 kW		09/02→			
33.410 FDAS, FDAS-WW, FDALS	301 kW		09/02→			
33.410 FDC, FDC-WW, FDLK, FDLRC, FDRK-WW	301 kW		10/00→			
33.410 FDK, FDK-WW, FDLK, FDRK-WW	301 kW		10/00→			
33.410 FDS, FDS-WW, FDLK, FDLRS, FDRS-WW	301 kW		10/00→			
33.410 FD-TM, FDR-TM	301 kW		10/00→			
33.460 FDAC-WW	338 kW		09/02→			
33.460 FDAK-WW	338 kW		09/02→			
33.460 FDAS-WW	338 kW		09/02→			
33.460 FDC, FDC-WW, FDLK, FDLRC, FDRK-WW	338 kW		09/02→			
33.460 FDK, FDK-WW, FDLK, FDRK-WW	338 kW		09/02→			
33.460 FDS, FDLK, FDLRS, FDRS-WW	338 kW		09/02→			
33.460 FD-TM, FDR-TM	338 kW		09/02→			
33.480 FDAC, FDAC-WW, FDALC, FDARC	353 kW		09/02→			
33.480 FDAC, FDALC, FDHC, FDHC/M	353 kW		02/06→			
33.480 FDAK, FDAK-WW, FDALK	353 kW		09/02→			
33.480 FDAK, FDALK, FDHK	353 kW		02/06→			
33.480 FDAS, FDALS, FDHS	353 kW		02/06→			
33.480 FDAS, FDAS-WW, FDARS, FDALS	353 kW		09/02→			
33.480 FDC, FDC-WW, FDLK, FDLRC, FDRK-WW	353 kW		09/02→			
33.480 FDC, FDLK, FDRK, FDC/M	353 kW		01/06→			
33.480 FDK, FDK-WW, FDLK, FDRK-WW	353 kW		09/02→			
33.480 FDK, FDLK, FDRK	353 kW		01/06→			
33.480 FDS, FDLK, FDLRS, FDRS, FDS/M	353 kW		01/06→			
33.480 FDS, FDS-WW, FDLK, FDLRS, FDRS-WW, FDLRS	353 kW		09/02→			
33.480 FD-TM	353 kW		09/02→			
33.510 FDC, FDC/M, FDLK, FDLRC	375 kW		09/02→			
33.510 FDS, FDLK, FDLRS, FDRS, FDLRS/M	375 kW		09/02→			
33.530 FDAC, FDALC	390 kW		09/02→			
33.530 FDAK, FDALK	390 kW		09/02→			

Manufacturer - Model	Power	Displ.	Year of Constr.	Remark	Part Number	Page
MAN - TGA						04/00→
33.530 FDAS, FDALS	390 kW		09/02→	+ OE 81061300170/5; Vers. produced by BEHR	8ML 376 724-211 Intercooler, charger	594
33.530 FDC, FDC/M, FDLK, FDLRC, FDLRC	390 kW		09/02→			
33.530 FDK, FDLK	390 kW		07/03→	Depth [mm]: 66; + OE 81061300176/8; L 685 mm; Vers. produced by BEHR; W 892 mm	8ML 376 724-221 Intercooler, charger	594
33.530 FDS, FDLS, FDLS/M, FDRS, FDLRS	390 kW		07/03→			
35.310 FFDC, FFDLC	228 kW		06/03→	Depth [mm]: 64; + OE 81061300216; L 665 mm; Observe technical data: 1; Vers. produced by BEHR; W 892 mm	8ML 376 724-321 Intercooler, charger	595
35.310 FFDK, FFDLK	228 kW		06/03→			
35.310 FFD-TM	228 kW		11/03→	Depth [mm]: 64; L 892 mm; Vers. produced by BEHR; W 665 mm	8ML 376 724-371 Intercooler, charger	596
35.360 FFDC, FFDLC	265 kW		10/03→			
35.360 FFDK, FFDLK	265 kW		10/03→	+ OE 81061300215; Observe technical data: 1; Vers. produced by BEHR	8ML 376 724-381 Intercooler, charger	597
35.360 FFD-TM	265 kW		11/03→			
35.410 FDNLC	301 kW		07/06→			
35.410 FFDK	301 kW		07/06→			
35.410 FFDC, FFDLC	301 kW		10/03→			
35.410 FFDK, FFDLK	301 kW		10/03→			
35.410 FFD-TM	301 kW		11/03→			
35.410 FFNLC	301 kW		07/06→			
35.460 FFDC, FFDLC	338 kW		10/03→			
35.460 FFDK, FFDLK	338 kW		10/03→			
35.460 FFD-TM	338 kW		11/03→			
35.460 FFNLC	338 kW		07/06→			
35.480 FFDARS	353 kW		07/06→			
35.480 FFDC, FFDLC	353 kW		10/03→			
35.480 FFDK, FFDLK	353 kW		10/03→			
35.480 FFD-TM	353 kW		11/03→			
35.530 FDNLC	390 kW		04/04→			
35.530 FFDK	390 kW		07/06→			
35.530 FFDC, FFDLC	390 kW		04/04→			
35.530 FFDK, FFDLK	390 kW		04/04→			
35.530 FFD-TM	390 kW		04/04→			
35.530 FFNLC	390 kW		07/06→			
37.310 FFDC	228 kW		12/04→			
37.310 FFDK	228 kW		12/04→			
37.310 FFD-TM	228 kW		12/04→			
37.360 FFDC	265 kW		12/04→			
37.360 FFDK	265 kW		12/04→			
37.360 FFD-TM	265 kW		12/04→			
37.410 FFDC	301 kW		12/04→			
37.410 FFDK	301 kW		12/04→			
37.410 FFD-TM	301 kW		12/04→			
37.460 FFDC	338 kW		12/04→			
37.460 FFDK	338 kW		12/04→			
37.460 FFD-TM	338 kW		12/04→			
37.480 FFDC	353 kW		12/04→			
37.480 FFDK	353 kW		12/04→			
37.480 FFD-TM	353 kW		12/04→			
37.530 FFDC	390 kW		12/04→			
37.530 FFDK	390 kW		12/04→			
37.530 FFD-TM	390 kW		12/04→			
37.530 FVDS, FVDLS	390 kW		07/06→			
40.390, 40.400 FDAK-WW	287 - 294 kW		06/05→			
40.390, 40.400 FDAS-WW	287 - 294 kW		06/05→			
40.410 FDAK-WW	301 kW		04/04→			
40.410 FDAS-WW	301 kW		04/04→			
40.410 FDK-WW	301 kW		04/04→			
40.410 FDS-WW	301 kW		04/04→			
40.460 FDAK-WW	338 kW		04/04→			
40.460 FDAS-WW	338 kW		04/04→			
40.460 FDK-WW	338 kW		04/04→			
40.460 FDS-WW	338 kW		04/04→			
40.480 FDAK-WW	353 kW		04/04→			
40.480 FDAK-WW	353 kW		06/05→			
40.480 FDAS-WW	353 kW		04/04→			
40.480 FDAS-WW	353 kW		06/05→			
40.480 FDK-WW	353 kW		04/04→			
40.480 FDS-WW	353 kW		04/04→			
41.360 FFDC, FFDC/M, FFDC/M-WW, FFDRC	265 kW		01/03→			
41.360 FFDK-WW	265 kW		09/03→			
41.360 FFD-TM	265 kW		12/04→			
41.410 FFDK	301 kW		07/06→			
41.410 FFDC-WW, FDRK	301 kW		09/03→			
41.410 FFDK-WW	301 kW		09/03→			
41.410 FFD-TM	301 kW		12/04→			
41.460 FFDC-WW, FFDRC	338 kW		09/03→			
41.460 FFDK-WW	338 kW		09/03→			
41.460 FFD-TM	338 kW		12/04→			
41.480 FFDARC	353 kW		07/06→			
41.480 FFDC, FFDRC, FFDC/M	353 kW		02/06→			
41.480 FFDC-WW, FFDRC	353 kW		06/05→			

Manufacturer - Model	Power	Displ.	Year of Constr.	Remark	Part Number	Page
MAN - TGA						04/00→
41.480 FFDK, FFDRK	353 kW		02/06→	+ OE 81061300170/5; Vers. produced by BEHR	8ML 376 724-211 Intercooler, charger	594
41.480 FFDK-WW	353 kW		06/05→			
41.480 FFD-TM	353 kW		12/04→			
41.480 FFDK-TM	353 kW		02/06→	Depth [mm]: 66; + OE 81061300176/8; L 685 mm; Vers. produced by BEHR; W 892 mm	8ML 376 724-221 Intercooler, charger	594
41.480 FVDS, FVDLS	353 kW		07/06→			
41.530 FFDK	353 kW		07/06→	Depth [mm]: 64; + OE 81061300216; L 665 mm; Observe technical data: 1; Vers. produced by BEHR; W 892 mm	8ML 376 724-321 Intercooler, charger	595
41.530 FFDK	390 kW		07/06→			
41.530 FFDC	390 kW		12/04→	Depth [mm]: 64; L 892 mm; Vers. produced by BEHR; W 665 mm	8ML 376 724-371 Intercooler, charger	596
41.530 FFDK	390 kW		12/04→			
41.530 FFD-TM	390 kW		12/04→			
41.530 FVDS, FVDLS	390 kW		09/02→	+ OE 81061300215; Observe technical data: 1; Vers. produced by BEHR	8ML 376 724-381 Intercooler, charger	597
18.430, 18.440 FAC, FHLC	316 - 324 kW		05/04→	+ OE 81061300170/5; Vers. produced by BEHR	8ML 376 724-211 Intercooler, charger	594
18.430, 18.440 FAK, FALK, FALK-L, FHLK, FHLK/M	316 - 324 kW		05/04→			
18.430, 18.440 FAS, FALS, FHLS, FHLS/M	316 - 324 kW		05/04→	Depth [mm]: 66; + OE 81061300176/8; L 685 mm; Vers. produced by BEHR; W 892 mm	8ML 376 724-221 Intercooler, charger	594
18.430, 18.440 FC, FLC, FLLC, FLLW, FLLW/N, FLLRC, FLLRW	316 - 324 kW		05/04→	Depth [mm]: 64; + OE 81061300216; L 665 mm; Observe technical data: 1; Vers. produced by BEHR; W 892 mm	8ML 376 724-321 Intercooler, charger	595
18.430, 18.440 FK, FK-L, FLK, FLK/M	316 - 324 kW		05/04→	Depth [mm]: 64; L 665 mm; Vers. produced by BEHR; W 892 mm	8ML 376 724-361 Intercooler, charger	595
18.430 FLS, FLS/M, FLS-TS, FLLS, FLLS/N, FLLRS, FLRS	316 kW		05/04→	Depth [mm]: 64; L 892 mm; Vers. produced by BEHR; W 665 mm	8ML 376 724-371 Intercooler, charger	596
19.430 FS/M-WW, FLS, FRS, FLRS	316 kW		05/04→	+ OE 81061300215; Observe technical data: 1; Vers. produced by BEHR	8ML 376 724-381 Intercooler, charger	597
24.430, 24.440 FNLLC/N, FNLRC, FNLLW	316 - 324 kW		05/04→	Depth [mm]: 64; L 931 mm; →Model 2008; Vers. produced by BEHR; W 732 mm	8ML 376 755-451 Intercooler, charger	599
24.430, 24.440 FPLS, FPLRS	316 - 324 kW		05/04→			
26.430, 26.440 FNLC, FNLLC, FNLLW, FNLRC, FNLLRC, FVLC	316 - 324 kW		05/04→			
26.430, 26.440 FNLS, FNLLS, FNLRS, FNLLRS, FPLS, FPLRS	316 - 324 kW		05/04→			
26.430, 26.440 FDC, FDRC, FDLC, FDLRC, FDLC/M, FNLHC, FVHLC	316 - 324 kW		05/04→			
26.430, 26.440 FDK, FDLK	316 - 324 kW		05/04→			
26.430, 26.440 FDS, FDLS, FDRS, FDLRS, FNHLS, FPHLS, FVHLS	316 - 324 kW		02/04→			
26.430 FDAC, FDALC	316 kW		01/04→			
26.430 FDAK, FDALK	316 kW		01/04→			
26.430 FDAS, FDALS	316 kW		01/04→			
26.430 FVL-KO	316 kW		12/00→			
26.430 FVLS, FVLR	316 kW		07/05→			
28.430 FANLC	316 kW		07/06→			
28.430 FANLK	316 kW		07/06→			
28.430 FNLS, FNLRS-WW	316 kW		05/04→			
32.430, 32.440 FFDRK	316 - 324 kW		05/04→			
32.430, 32.440 FFD-TM, FFDR-TM	316 - 324 kW		05/04→			
35.430, 35.440 FFDC, FFDRK, FFDC	316 - 324 kW		02/04→			
35.430, 35.440 FFDK, FFDRK, FFDLK	316 - 324 kW		02/04→			
35.430, 35.440 FFD-TM	316 - 324 kW		02/04→			
35.430 FDNLC	316 kW		07/06→			
35.430 FFDK, FFDHK, FFDHLK	316 kW		07/06→			
35.430 FFDH-TM	316 kW		07/06→			
35.430 FFNLC	316 kW		07/06→			
37.430, 37.440 FFDC	316 - 324 kW		12/04→			
37.430, 37.440 FFDK	316 - 324 kW		12/04→			
37.430, 37.440 FFD-TM	316 - 324 kW		12/04→			
39.430 FVNLC	316 kW		07/06→			
40.430 FDK-WW, FDRK	316 kW		06/05→			
40.430 FDS-WW, FDRS	316 kW		06/05→			
41.430, 41.440 FFDC, FFDRK, FFDC/M	316 - 324 kW		12/04→			
41.430, 41.440 FFDK, FFDRK	316 - 324 kW		12/04→			
41.430, 41.440 FFD-TM	316 - 324 kW		12/04→			
41.430 FFDK	316 kW		12/04→			
41.430 FFDC-TM, FFDRK	316 kW		09/07→			
18.480 FK, FK-L, FLK	353 kW		01/06→	Depth [mm]: 64; L 665 mm; Vers. produced by BEHR; W 892 mm	8ML 376 724-361 Intercooler, charger	595
27.440 FDS, FDLS, FDRS, FDLRS	324 kW		10/08→			
35.390 FFNLC	287 kW		07/06→			
40.390, 40.400 FDK-WW, FDRK	287 - 294 kW		06/05→			
40.390, 40.400 FDS-WW, FDRS	287 - 294 kW		06/05→			
26.430, 26.440 FDHC, FDHC/M, FDHLC	316 - 324 kW		06/05→	+ OE 81061300170/5; Vers. produced by BEHR	8ML 376 724-211 Intercooler, charger	594
26.430, 26.440 FDHK, FDHLK	316 - 324 kW		06/05→	Depth [mm]: 66; + OE 81061300176/8; L 685 mm; Vers. produced by BEHR; W 892 mm	8ML 376 724-221 Intercooler, charger	594

Manufacturer - Model	Power	Displ.	Year of Constr.	Remark	Part Number	Page
MAN - TGA						04/00→
26.430, 26.440 FDHS, FDHS/M, FDHLS	316 - 324 kW		06/05→	Depth [mm]: 64; + OE 81061300216; L 665 mm; Observe technical data: 1; Vers. produced by BEHR; W 892 mm	8ML 376 724-321 Intercooler, charger	595
26.430, 26.440 FDH-TM	316 - 324 kW		06/05→	Depth [mm]: 64; L 892 mm; Vers. produced by BEHR; W 665 mm	8ML 376 724-371 Intercooler, charger	596
26.430, 26.440 FD-TM	316 - 324 kW		05/04→			
26.430, 26.440 FVLH-KO	316 - 324 kW		06/05→	+ OE 81061300215; Observe technical data: 1; Vers. produced by BEHR	8ML 376 724-381 Intercooler, charger	597
26.430 FDLS, FDLS/M, FDLRS-WW	316 - 324 kW		02/04→			
28.430, 28.440 FNLK, FNLLC, FNLRC-WW	316 - 324 kW		06/04→	Depth [mm]: 64; L 931 mm; →Model 2008; Vers. produced by BEHR; W 732 mm	8ML 376 755-451 Intercooler, charger	599
33.430, 33.440 FDAC, FDALC, FDHC, FDHC/M	316 - 324 kW		06/05→			
33.430, 33.440 FDAK, FDALK, FDHK	316 - 324 kW		06/05→	Depth [mm]: 64; L 931 mm; →Model 2008; Vers. produced by BEHR; W 732 mm	8ML 376 755-451 Intercooler, charger	599
33.430, 33.440 FDAS, FDALS, FDHS	316 - 324 kW		06/05→			
33.430, 33.440 FDC, FDLK, FDLRC, FDLRC/M	316 - 324 kW		05/04→	Depth [mm]: 64; L 931 mm; →Model 2008; Vers. produced by BEHR; W 732 mm	8ML 376 755-451 Intercooler, charger	599
33.430, 33.440 FDK, FDLK, FDRK	316 - 324 kW		05/04→			
33.430, 33.440 FDS, FDLS, FDRS, FDLRS, FDS/M	316 - 324 kW		05/04→	Depth [mm]: 64; L 931 mm; →Model 2008; Vers. produced by BEHR; W 732 mm	8ML 376 755-451 Intercooler, charger	599
40.430, 40.440 FDAK-WW	316 - 324 kW		06/05→			
40.430, 40.440 FDAS-WW	316 - 324 kW		06/05→	Depth [mm]: 64; L 931 mm; →Model 2008; Vers. produced by BEHR; W 732 mm	8ML 376 755-451 Intercooler, charger	599
MAN - TGL						04/05→
10.220 FC, FLC, FRC, FLRC	162 kW		04/05→	Depth [mm]: 50; L 535 mm; Vers. produced by BEHR; W 512 mm	8ML 376 728-701 Intercooler, charger	597
10.220 FK, FRK	162 kW		04/05→			
12.220 FC, FRC, FLC, FLRC	162 kW		04/05→	Depth [mm]: 50; L 535 mm; Vers. produced by BEHR; W 712 mm	8ML 376 733-401 Intercooler, charger	598
12.220 FK, FRK	162 kW		04/05→			
7.220 FC, FLC, FRC, FLRC	162 kW		04/05→	Depth [mm]: 50; L 535 mm; Vers. produced by BEHR; W 712 mm	8ML 376 733-401 Intercooler, charger	598
8.220 FC, FLC, FRC, FLRC	162 kW		04/05→			
8.220 FK, FRK, FK-L, FRK-L	162 kW		04/05→	Depth [mm]: 50; L 535 mm; Vers. produced by BEHR; W 712 mm	8ML 376 733-401 Intercooler, charger	598
10.240 FC, FRC, FLC, FLRC	176 kW		04/05→			
10.240 FK, FRK	176 kW		04/05→	Depth [mm]: 64; L 712 mm; Vers. produced by BEHR; W 535 mm	8ML 376 746-301 Intercooler, charger	598
10.250 FC, FLC, FRC, FLRC	184 kW		04/05→	Depth [mm]: 50; L 535 mm; Vers. produced by BEHR; W 712 mm	8ML 376 733-401 Intercooler, charger	598
10.250 FK, FRK	184 kW		04/05→			
12.250 FC, FLC, FRC, FLRC	184 kW		04/05→	Depth [mm]: 64; L 712 mm; Vers. produced by BEHR; W 535 mm	8ML 376 746-301 Intercooler, charger	598
12.250 FK, FRK	184 kW		04/05→			
7.250 FC, FLC, FRC, FLRC	184 kW		04/05→	Indirect charge air cooler; Depth [mm]: 132; L 552 mm; Vers. produced by BEHR; W 352 mm	8ML 376 756-001 Intercooler, charger	599
8.250 FC, FLC, FRC, FLRC	184 kW		04/05→			
8.250 FK, FK-L, FRK, FRK-L	184 kW		04/05→	Depth [mm]: 50; L 535 mm; Vers. produced by BEHR; W 512 mm	8ML 376 728-701 Intercooler, charger	597
12.180 FC, FRC, FLC, FLRC	132 kW		04/05→			
12.180 FK, FRK	132 kW		04/05→	Depth [mm]: 50; L 535 mm; Vers. produced by BEHR; W 512 mm	8ML 376 728-701 Intercooler, charger	597
12.210 FC, FRC, FLC, FLRC	151 kW		04/05→			
12.210 FK, FRK	151 kW		04/05→	Depth [mm]: 50; L 535 mm; Vers. produced by BEHR; W 512 mm	8ML 376 728-701 Intercooler, charger	597
8.180 FC, FRC, FLC, FLRC	132 kW		04/05→			
8.180 FK, FK-L, FRK, FRK-L	132 kW		04/05→	Depth [mm]: 50; L 535 mm; Vers. produced by BEHR; W 512 mm	8ML 376 728-701 Intercooler, charger	597
8.210 FC, FRC, FLC, FLRC	151 kW		04/05→			
8.210 FK, FK-L, FRK, FRK-L	151 kW		04/05→	Depth [mm]: 50; L 535 mm; Vers. produced by BEHR; W 512 mm	8ML 376 728-701 Intercooler, charger	597
12.240 FC, FRC, FLC, FLRC	176 kW		04/05→			
12.240 FK, FRK	176 kW		04/05→	Depth [mm]: 50; L 535 mm; Vers. produced by BEHR; W 712 mm	8ML 376 733-401 Intercooler, charger	598
8.240 FC, FRC, FLC, FLRC	176 kW		04/05→			
8.240 FK, FK-L, FRK, FRK-L	176 kW		04/05→	Depth [mm]: 64; L 712 mm; Vers. produced by BEHR; W 535 mm	8ML 376 746-301 Intercooler, charger	598
MAN - TGM						10/05→
12.240 FLC, FLLC	176 kW		10/05→	Depth [mm]: 64; L 712 mm; Vers. produced by BEHR; W 535 mm	8ML 376 746-301 Intercooler, charger	598
12.280 FC, FLC, FLLC	206 kW		10/05→			
15.240 FC, FLC, FLLC, FLRC, FLLRC	176 kW		10/05→	Depth [mm]: 64; L 712 mm; Vers. produced by BEHR; W 535 mm	8ML 376 746-301 Intercooler, charger	598
15.280 FC, FLC, FLLC, FLRC, FLLRC	206 kW		10/05→			
26.280 FDK-HK, FDRK-HK	206 kW		04/06→	Indirect charge air cooler; Depth [mm]: 132; L 552 mm; Vers. produced by BEHR; W 352 mm	8ML 376 756-001 Intercooler, charger	599
26.280 FD-TM, FDR-TM	206 kW		04/06→			
26.330 FDK-HK, FDRK-HK	240 kW		04/06→	Depth [mm]: 50; L 535 mm; Vers. produced by BEHR; W 712 mm	8ML 376 733-401 Intercooler, charger	598
26.330 FD-TM, FDR-TM	240 kW		04/06→			
12.250 FLC, FLLC	184 kW		10/05→	Depth [mm]: 64; L 712 mm; Vers. produced by BEHR; W 535 mm	8ML 376 746-301 Intercooler, charger	598
12.290 FLC, FLLC	213 kW		10/05→			
13.250 FAEC, FAERC, FALC, FAL, FALRC, FALR	184 kW		10/05→	Indirect charge air cooler; Depth [mm]: 132; L 552 mm; Vers. produced by BEHR; W 352 mm	8ML 376 756-001 Intercooler, charger	599
13.250 FALK, FALRK, FALK-L, FALRK-L	184 kW		10/05→			
13.290 FAEC, FAERC, FAL, FALR, FALC, FALRC	213 kW		10/05→			

Manufacturer - Model	Power	Displ.	Year of Constr.	Remark	Part Number	Page
MAN - TGM						10/05→
13.290 FALK, FALRK, FALK-L, FALRK-L	213 kW		10/05→	Depth [mm]: 50; L 535 mm; Vers. produced by BEHR; W 712 mm	8ML 376 733-401 Intercooler, charger	598
15.250 FC, FLC, FLRC, FLLC, FLLRC	184 kW		10/05→			
15.250 FLK, FLRK	184 kW		10/05→			
15.290 FC, FLC, FLRC, FLLC, FLLRC	213 kW		10/05→	Indirect charge air cooler; Depth [mm]: 132; L 552 mm; Vers. produced by BEHR; W 352 mm	8ML 376 756-001 Intercooler, charger	599
15.290 FLK, FLRK	213 kW		10/05→			
15.340 FC, FLC, FLRC	250 kW		10/05→			
15.340 FLK, FLRK	250 kW		10/05→			
18.250 FAC, FARC	184 kW		10/05→			
18.250 FAK, FARK, FAK-L, FARK-L	184 kW		10/05→			
18.250 FC, FLC, FLLC, FRC, FLRC, FLLRC	184 kW		10/05→			
18.250 FK, FLK, FRK, FLRK	184 kW		10/05→			
18.290 FAC, FARC	213 kW		10/05→			
18.290 FAK, FARK, FAK-L, FARK-L	213 kW		10/05→			
18.290 FC, FLC, FRC, FLRC, FLLC, FLLRC	213 kW		10/05→			
18.290 FK, FLK, FRK, FLRK	213 kW		10/05→			
18.340 FAC, FARC	250 kW		10/05→			
18.340 FAK, FARK, FAK-L, FARK-L	250 kW		10/05→			
18.340 FC, FLC, FLRC, FLLC, FLLRC, FRC	250 kW		10/05→			
18.340 FK, FRK, FLK, FLRK	250 kW		10/05→			
22.250 FNLLC	184 kW		10/05→			
22.290 FNL, 22.290 FNLLC	213 kW		10/05→			
26.290 FD, FDR	213 kW		10/05→			
26.290 FDK-HK, FDRK-HK	213 kW		10/05→			
26.290 FD-TM, FDR-TM	213 kW		07/08→			
26.290 FNLC, FNLLC, FNLRC, FNLLRC, FVL	213 kW		10/05→			
26.340 FD, FDR	250 kW		10/05→			
26.340 FDK-HK, FDRK-HK	250 kW		10/05→			
26.340 FD-TM, FDR-TM	250 kW		07/08→			
26.340 FNLC, FNLLC, FNLRC, FNLLRC	250 kW		10/05→			
13.240 FAL, FALC, FALRC, FAEC, FAERC, FALR	176 kW		04/06→	Depth [mm]: 50; L 535 mm; Vers. produced by BEHR; W 712 mm	8ML 376 733-401 Intercooler, charger	598
13.240 FALK, FALRK, FALK-L, FALRK-L	176 kW		04/06→			
13.280 FAEC, FAERC, FAL, FALC, FALRC	206 kW		04/06→	Depth [mm]: 64; L 712 mm; Vers. produced by BEHR; W 535 mm	8ML 376 746-301 Intercooler, charger	598
13.280 FALK, FALRK, FALK-L, FALRK-L	206 kW		04/06→			
15.240 FLK, FLRK	176 kW		10/05→			
15.280 FLK, FLRK	206 kW		10/05→			
15.330 FC, FLC, FRC, FLRC	240 kW		10/05→			
15.330 FLK, FLRK	240 kW		10/05→			
18.240 FAC, FARC	176 kW		10/05→			
18.240 FAK, FARK, FAK-L, FARK-L	176 kW		05/06→			
18.240 FC, FRC, FLC, FLRC, FLLC, FLLRC	176 kW		10/05→			
18.240 FK, FRK, FLK, FK-L, FLRK	176 kW		10/05→			
18.280 FAC, FARC	206 kW		10/05→			
18.280 FAK, FARK, FAK-L, FARK-L	206 kW		10/05→			
18.280 FC, FRC, FLC, FLRC, FLLC, FLLRC	206 kW		10/05→			
18.280 FK, FLK, FRK, FLRK, FK-L	206 kW		10/05→			
18.330 FAC, FARC	240 kW		10/05→			
18.330 FAK, FARK, FAK-L, FARK, L	240 kW		10/05→			
18.330 FC, FRC, FLC, FLRC, FLLC, FLLRC	240 kW		10/05→			
18.330 FK, FLK, FRK, FLRK, FK-L	240 kW		10/05→			
22.240 FNLLC	176 kW		10/05→			
22.280 FNL, 22.280 FNLLC	206 kW		10/05→			
26.280 FD	206 kW		10/05→			
26.280 FNLC, FNLLC, FNLRC, FNLLRC	206 kW		10/05→			
26.330 FD, FDR	240 kW		10/05→			
26.330 FNLC, FNLLC, FNLRC, FNLLRC, FVL	240 kW		10/05→			

Manufacturer - Model	Power	Displ.	Year of Constr.	Remark	Part Number	Page
MAN - TGS						09/07→
18.320 FAC, FHLC	235 kW		10/07→	Depth [mm]: 64; L 665 mm; Vers. produced by BEHR; W 892 mm	8ML 376 724-361 Intercooler, charger	595
18.320 FAK, FAK-L, FALK, FALK-L, FHLK, FHLK/M	235 kW		10/07→			
18.320 FAS, FHLS, FHLS/M	235 kW		10/07→	+ OE 81061300215; Observe technical data: 1; Vers. produced by BEHR	8ML 376 724-381 Intercooler, charger	597
18.320 FC, FLC, FLRC, FLLC, FLLRC, FLLW, FLLW/N	235 kW		10/07→			
18.320 FK, FK-L, FLK, FLK/M	235 kW		10/07→			
18.320 FLS, FLS/M, FLS-TS, FLRS, FLRS/M, FLLS, FLLS/N, FLLRS	235 kW		10/07→			
18.360 FAC, FHLC	265 kW		10/07→			
18.360 FAK, FAK-L, FALK, FALK-L, FHLK, FHLK/M	265 kW		10/07→			
18.360 FAS, FALS, FHLS, FHLS/M	265 kW		10/07→			
18.360 FC, FLC, FLRC, FLLC, FLLRC, FLLW, FLLW/N	265 kW		10/07→			
18.360 FK, FK-L, FLK, FLK/M	265 kW		10/07→			
18.360 FLS, FLS/M, FLS-TS, FLRS, FLRS/M, FLLS, FLLS/N, FLLRS	265 kW		10/07→			
18.400 FAC, FHLC	294 kW		10/07→			
18.400 FAK, FAK-L, FALK, FALK-L, FHLK, FHLK/M	294 kW		10/07→			
18.400 FAS, FALS, FHLS, FHLS/M	294 kW		10/07→			
18.400 FC, FLC, FLRC, FLLC, FLLRC, FLLW, FLLW/N	294 kW		10/07→			
18.400 FK, FK-L, FLK, FLK/M	294 kW		10/07→			
18.400 FLS, FLS/M, FLS-TS, FLRS, FLRS/M, FLLS, FLLS/N, FLLRS	294 kW		10/07→			
18.440 FAC, FHLC	324 kW		10/07→			
18.440 FAK, FAK-L, FALK, FALK-L, FHLK, FHLK/M	324 kW		10/07→			
18.440 FAS, FALS, FHLS, FHLS/M	324 kW		10/07→			
18.440 FC, FLC, FLRC, FLLC, FLLRC, FLLW, FLLW/N	324 kW		10/07→			
18.440 FK, FK-L, FLK, FLK/M	324 kW		10/07→			
18.440 FLS, FLS/M, FLS-TS, FLRS, FLRS/M, FLLS, FLLS/N, FLLRS	324 kW		10/07→			
18.480 FAC, FHLC	353 kW		10/07→			
18.480 FAK, FAK-L, FALK, FALK-L, FHLK, FHLK/M	353 kW		10/07→			
18.480 FAS, FALS, FHLS	353 kW		10/07→			
18.480 FC, FLC, FLRC, FLLC, FLLRC, FLLW, FLLW/N	353 kW		10/07→			
18.480 FK, FK-L, FLK, FLK/M	353 kW		10/07→			
18.480 FLS, FLS/M, FLS-TS, FLRS, FLRS/M, FLLS, FLLS/N, FLLRS	353 kW		10/07→			
18.540 FAC, FHLC	397 kW		10/07→			
18.540 FAK, FAK-L, FALK, FALK-L, FHLK, FHLK/M	397 kW		10/07→			
18.540 FAS, FALS, FHLS, FHLS/M	397 kW		10/07→			
18.540 FC, FLC, FLRC, FLLC, FLLRC, FLLW, FLLW/N	397 kW		10/07→			
18.540 FK, FK-L, FLK, FLK/M	397 kW		10/07→			
18.540 FLS, FLS/M, FLRS, FLRS/M, FLLS, FLLS/N, FLLRS	397 kW		10/07→			
24.320 FNLLW/N	235 kW		10/07→			
24.360 FNLLW/N	265 kW		10/07→			
24.360 FPLS, FPLRS	265 kW		10/07→			
24.400 FNLLW/N	294 kW		10/07→			
24.400 FPLS, FPLRS	294 kW		10/07→			
24.440 FNLLW/N	324 kW		10/07→			
24.440 FPLS, FPLRS	324 kW		10/07→			
24.480 FPLS, FPLRS	353 kW		10/07→			
24.540 FPLS, FPLRS	397 kW		10/07→			
26.320 FDAC, FDALC, FDHLC, FDHLC/M	235 kW		07/08→			
26.320 FDAK, FDALK, FDHK, FDHLK	235 kW		07/08→			
26.320 FDAS, FDALS, FDHS, FDHLS, FDHLS/M	235 kW		07/08→			
26.320 FDC, FDRC, FDLC, FDLC/M, FDLRC, FDLRC/M, FNHLC	235 kW		07/08→			

Manufacturer - Model	Power	Displ.	Year of Constr.	Remark	Part Number	Page
MAN - TGS						09/07→
26.320 FDK, FDLK	235 kW		07/08→	Depth [mm]: 64; L 665 mm; Vers. produced by BEHR; W 892 mm	8ML 376 724-361 Intercooler, charger	595
26.320 FDS, FDLS, FDLS/M, FDRS, FDLRS, FDLRS/M, FNHLS	235 kW		07/08→			
26.320 FD-TM	235 kW		07/08→	+ OE 81061300215; Observe technical data: 1; Vers. produced by BEHR	8ML 376 724-381 Intercooler, charger	597
26.320 FNLC, FNLRC, FNLLC, FNLLRC, FNLLW, FVLC, FVL-KO	235 kW		10/07→			
26.320 FNLS, FNLRS, FNLLS, FPLS, FVLS	235 kW		07/08→			
26.320 FVHLC	235 kW		10/07→			
26.360 FDAC, FDALC, FDHLC, FDHLC/M	265 kW		08/08→			
26.360 FDAK, FDALK, FDHK, FDHLK	265 kW		08/08→			
26.360 FDAS, FDALS, FDHS, FDHLS, FDHLS/M	265 kW		08/08→			
26.360 FDC, FDRC, FDRC/M, FDLC, FDLRC, FNHLC	265 kW		08/08→			
26.360 FDK, FDLK, FDRK	265 kW		08/08→			
26.360 FDS, FDRS, FDRS/M, FDLS, FDLRS, FNHLS	265 kW		08/08→			
26.360 FD-TM	265 kW		07/08→			
26.360 FNLC, FNLRC, FNLLC, FNLLRC, FVLC, FVL-KO	265 kW		10/07→			
26.360 FNLLW	265 kW		04/08→			
26.360 FNLS, FNLLS, FNLRS, FPLS, FPLRS, FVLS	265 kW		08/08→			
26.360 FPHLS	265 kW		05/08→			
26.360 FVHLC	265 kW		10/07→			
26.360 FVHLS	265 kW		05/08→			
26.400 FDAC, FDALC, FDHLC, FDHLC/M	294 kW		02/09→			
26.400 FDAK, FDALK, FDHK, FDHLK	294 kW		11/07→			
26.400 FDAS, FDALS, FDHS, FDHLS, FDHLS/M	294 kW		09/07→			
26.400 FDC, FDRC, FDC/M, FDLC, FDLC/M, FDLRC, FDLRC/M, FNHLC	294 kW		08/08→			
26.400 FDK, FDLK	294 kW		02/09→			
26.400 FDS, FDS/M, FDLS, FDLRS, FDLRS, FNHLS	294 kW		02/09→			
26.400 FD-TM	294 kW		07/08→			
26.400 FNLC, FNLRC, FNLLC, FNLLRC, FVLC, FVL-KO, FNLLW	294 kW		10/07→			
26.400 FNLS, FNLRS, FNLLS, FNLLRS, FPLS, FPLRS, FVLS	294 kW		02/09→			
26.400 FPHLS	294 kW		05/08→			
26.400 FVHLC	294 kW		10/07→			
26.400 FVHLS	294 kW		05/08→			
26.440 FDAC, FDALC, FDHLC, FDHLC/M	324 kW		02/09→			
26.440 FDAK, FDALK, FDHK, FDHLK	324 kW		11/07→			
26.440 FDAS, FDALS, FDHLS, FDHLS/M	324 kW		02/09→			
26.440 FDC, FDRC, FDC/M, FDLC, FDLC/M, FDLRC, FNHLC	324 kW		02/09→			
26.440 FDK, FDLK	324 kW		07/08→			
26.440 FDS, FDRS, FDS/M, FDLS, FDLRS, FNHLS	324 kW		02/09→			
26.440 FD-TM	324 kW		07/08→			
26.440 FNLC, FNLLC, FNLLW, FNLRC, FNLLRC, FVLC, FVL-KO	324 kW		10/07→			
26.440 FNLS, FNLLS, FNLRS, FPLS, FPLRS, FVLS	324 kW		02/09→			
26.440 FPHLS	324 kW		05/08→			
26.440 FVHLC	324 kW		10/07→			
26.440 FVHLS	324 kW		05/08→			
26.480 FDAC, FDALC, FDHLC, FDHLC/M	353 kW		02/09→			
26.480 FDAK, FDALK, FDHK, FDHLK	353 kW		02/09→			
26.480 FDAS, FDALS, FDHS, FDHLS	353 kW		02/09→			
26.480 FDC, FDC/M, FDLC, FDLC/M, FDRC, FDRC/M, FDLRC, FNLHC	353 kW		02/09→			
26.480 FDK, FDLK	353 kW		07/08→			

Manufacturer - Model	Power	Displ.	Year of Constr.	Remark	Part Number	Page
MAN - TGS						09/07→
26.480 FDS, FDS/M, FDLS, FDLS/M, FDRS, FDLRS, FDRS/M, FNHLS	353 kW		02/09→	Depth [mm]: 64; L 665 mm; Vers. produced by BEHR; W 892 mm	8ML 376 724-361	595
26.480 FNLRC, FNLRC, FNLLC, FNLLRC, FNLLW, FVLC, FVL-KO	353 kW		10/07→		+ OE 81061300215; Observe technical data: 1; Vers. produced by BEHR	8ML 376 724-381
26.480 FNLS, FNLLS, FNLRS, FPLS, FPLRS, FVLS	353 kW		02/09→			
26.480 FPHLS	353 kW		05/08→			
26.480 FVHLC	353 kW		10/07→			
26.480 FVHLS	353 kW		05/08→			
26.540 FDAC, FDALC, FDHLC, FDHLC/M	397 kW		02/09→			
26.540 FDAK, FDALK, FDHLK	397 kW		11/07→			
26.540 FDAS, FDALS, FDHLS	397 kW		02/09→			
26.540 FDC, FDC/M, FDLC, FDLC/M, FDLRC, FDLRC/M, FNHLC	397 kW		02/09→			
26.540 FDK, FDLK	397 kW		02/09→			
26.540 FDS, FDS/M, FDLS, FDRS, FDLRS, FDLS/M, FNHLS	397 kW		02/09→			
26.540 FNLC, FNLRC, FNLLC, FNLLRC, FNLLW, FVLC, FVL-KO	397 kW		10/07→			
26.540 FNLS, FNLLS, FPLS, FPLRS, FVLS	397 kW		02/09→			
28.320 FNHLC	235 kW		07/08→			
28.320 FNLC	235 kW		07/08→			
28.320 FNLS	235 kW		07/08→			
28.360 FANLC, FNHLC	265 kW		08/08→			
28.360 FANLK	265 kW		08/08→			
28.360 FNLC	265 kW		08/08→			
28.360 FNLS	265 kW		08/08→			
28.400 FANLC, FNHLC	294 kW		08/08→			
28.400 FANLK	294 kW		08/08→			
28.400 FNLC	294 kW		08/08→			
28.400 FNLS	294 kW		08/08→			
28.440 FANLC, FNHLC	324 kW		08/08→			
28.440 FANLK	324 kW		08/08→			
28.440 FNLC	324 kW		08/08→			
28.440 FNLS	324 kW		08/08→			
28.480 FANLC, FNHLC	353 kW		08/08→			
28.480 FANLK	353 kW		08/08→			
28.480 FNLC	353 kW		08/08→			
28.480 FNLS	353 kW		08/08→			
28.540 FNHLC	397 kW		06/08→			
28.540 FNLC	397 kW		02/09→			
28.540 FNLS	397 kW		02/09→			
32.320 FFD-TM	235 kW		02/09→			
32.360 FFDR	265 kW		08/08→			
32.360 FFD-TM, FFDR-TM	265 kW		10/07→			
32.400 FFDR	294 kW		08/08→			
32.400 FFD-TM, FFDR-TM	294 kW		10/07→			
32.440 FFDR	324 kW		08/08→			
32.440 FFD-TM, FFDR-TM	324 kW		10/07→			
32.480 FFD-TM	353 kW		08/08→			
33.360 FDAC, FDALC	265 kW		06/08→			
33.360 FDAK, FDALK, FDHK	265 kW		10/07→			
33.360 FDAS, FDALS, FDHS	265 kW		10/07→			
33.360 FDC, FDLC	265 kW		06/08→			
33.360 FDK, FDLK	265 kW		02/09→			
33.360 FDS, FDLS	265 kW		06/08→			
33.400 FDAC, FDALC	294 kW		07/08→			
33.400 FDAK, FDALK, FDHK	294 kW		07/08→			
33.400 FDAS, FDALS, FDHS	294 kW		07/08→			
33.400 FDC, FDLC	294 kW		06/08→			
33.400 FDK, FDLK	294 kW		07/08→			
33.400 FDS, FDLS	294 kW		07/08→			
33.440 FDAC, FDALC	324 kW		07/08→			
33.440 FDAK, FDALK, FDHK	324 kW		11/07→			
33.440 FDAS, FDALS, FDHS	324 kW		10/07→			
33.440 FDC, FDLC	324 kW		06/08→			
33.440 FDK, FDLK	324 kW		06/08→			
33.440 FDS, FDLS, FDLS/M	324 kW		06/08→			
33.480 FDAC, FDALC	353 kW		08/08→			
33.480 FDAK, FDALK	353 kW		08/08→			
33.480 FDAS, FDALS, FDHS	353 kW		10/07→			
33.480 FDC, FDC/M, FDLC, FDLC/M	353 kW		08/08→			
33.480 FDK, FDLK	353 kW		08/08→			
33.480 FDS, FDLS, FDLS/M	353 kW		08/08→			

Manufacturer - Model	Power	Displ.	Year of Constr.	Remark	Part Number	Page
MAN - TGS						09/07→
33.540 FDAC, FDALC	397 kW		02/09→	Depth [mm]: 64; L 665 mm; Vers. produced by BEHR; W 892 mm	8ML 376 724-361 Intercooler, charger	595
33.540 FDAK, FDALK	397 kW		02/09→			
33.540 FDAS, FDALS	397 kW		02/09→	+ OE 81061300215; Observe technical data: 1; Vers. produced by BEHR	8ML 376 724-381 Intercooler, charger	597
33.540 FDC, FDLC, FDLC/M	397 kW		02/09→			
33.540 FDK, FDLK	397 kW		02/09→			
33.540 FDS, FDLS, FDLS/M	397 kW		02/09→			
35.320 FFDAK	235 kW		06/08→			
35.320 FFDAK, FFDHLK	235 kW		06/08→			
35.320 FFDC, FFDLC, FDNLC	235 kW		06/08→			
35.320 FFDK, FFDLK	235 kW		08/08→			
35.320 FFD-TM	235 kW		10/07→			
35.320 FFNLC	235 kW		01/09→			
35.360 FFDAK	265 kW		06/08→			
35.360 FFDAK, FFHDLK	265 kW		06/08→			
35.360 FFDC, FFDLC, FDNLC	265 kW		06/08→			
35.360 FFDK, FFDLK, FFDRK	265 kW		08/08→			
35.360 FFD-TM	265 kW		10/07→			
35.360 FFNLC	265 kW		06/08→			
35.400 FFDAK	294 kW		06/08→			
35.400 FFDAK, FFDHLK	294 kW		06/08→			
35.400 FFDC, FFDLC, FDNLC	294 kW		06/08→			
35.400 FFDK, FFDLK, FFDRK	294 kW		08/08→			
35.400 FFD-TM	294 kW		10/07→			
35.400 FFNHLC	294 kW		10/07→			
35.400 FFNLC	294 kW		06/08→			
35.440 FDNLC, FFDC, FFDLC, FFNLC	324 kW		06/08→			
35.440 FFDAK	324 kW		06/08→			
35.440 FFDAK, FFDHLK	324 kW		06/08→			
35.440 FFDK, FFDLK, FFDRK	324 kW		08/08→			
35.440 FFD-TM	324 kW		10/07→			
35.440 FFNHLC	324 kW		10/07→			
35.440 FFNLC	324 kW		06/08→			
35.480 FDNLC, FFDC, FFDLC	353 kW		06/08→			
35.480 FFDAK	353 kW		06/08→			
35.480 FFDAK, FFDHLK	353 kW		06/08→			
35.480 FFDK, FFDLK, FFDRK	353 kW		08/08→			
35.480 FFD-TM	353 kW		10/07→			
35.480 FFNHLC	353 kW		10/07→			
35.480 FFNLC	353 kW		06/08→			
35.540 FDNLC, FFDC, FFDLC	397 kW		06/08→			
35.540 FFDAK	397 kW		02/09→			
35.540 FFDAK, FFDHLK	397 kW		02/09→			
35.540 FFDK, FFDLK, FFDRK	397 kW		02/09→			
35.540 FFD-TM	397 kW		10/07→			
35.540 FFNLC	397 kW		02/09→			
37.320 FFDC	235 kW		07/08→			
37.320 FFDK	235 kW		07/08→			
37.320 FFD-TM	235 kW		10/07→			
37.360 FFDC	265 kW		07/08→			
37.360 FFDK	265 kW		07/08→			
37.360 FFD-TM	265 kW		10/07→			
37.400 FFDC	294 kW		07/08→			
37.400 FFDK	294 kW		07/08→			
37.400 FFD-TM	294 kW		10/07→			
37.440 FFDC	324 kW		07/08→			
37.440 FFDK	324 kW		07/08→			
37.440 FFD-TM	324 kW		10/07→			
37.480 FFDC	353 kW		07/08→			
37.480 FFDK	353 kW		07/08→			
37.480 FFD-TM	353 kW		10/07→			
37.540 FFDC	397 kW		02/09→			
37.540 FFDK	397 kW		02/09→			
37.540 FFD-TM	397 kW		10/07→			
41.320 FFDAK	235 kW		06/08→			
41.360 FFDAK	265 kW		06/08→			
41.360 FFDC	265 kW		07/08→			
41.360 FFDK	265 kW		07/08→			
41.360 FFD-TM	265 kW		10/07→			
41.400 FFDC	294 kW		07/08→			
41.400 FFDK	294 kW		07/08→			
41.400 FFD-TM	294 kW		10/07→			
41.440 FFDAK	324 kW		06/08→			
41.440 FFDC	324 kW		07/08→			
41.440 FFDK	324 kW		07/08→			
41.440 FFD-TM	324 kW		10/07→			
41.480 FFDAK	353 kW		06/08→			
41.480 FFDARC	353 kW		06/08→			
41.480 FFDC	353 kW		07/08→			
41.480 FFDK	353 kW		07/08→			
41.480 FFD-TM	353 kW		10/07→			

Manufacturer - Model	Power	Displ.	Year of Constr.	Remark	Part Number	Page
MAN - TGS						09/07→
41.540 FFDK	397 kW		02/09→	Depth [mm]: 64; L 665 mm; Vers. produced by BEHR; W 892 mm + OE 81061300215; Observe technical data: 1; Vers. produced by BEHR	8ML 376 724-361 Intercooler, charger	595
41.540 FFDC	397 kW		02/09→			
41.540 FFDK	397 kW		02/09→			
41.540 FFD-TM	397 kW		10/07→		8ML 376 724-381 Intercooler, charger	597
MAN - TGX						09/07→
18.360 FHLC	265 kW		10/07→	Depth [mm]: 64; + OE 81061300216; L 665 mm; Observe technical data: 1; Vers. produced by BEHR; W 892 mm	8ML 376 724-321 Intercooler, charger	595
18.360 FHLS, FHLS/M	265 kW		10/07→			
18.360 FLC, FLRC, FLLC, FLLRC, FLLW, FLLW/N	265 kW		10/07→	Depth [mm]: 64; L 892 mm; Vers. produced by BEHR; W 665 mm	8ML 376 724-371 Intercooler, charger	596
18.360 FLS, FLS/M, FLRS, FLRS/N, FLLS, FLLS/N, FLLRS, FLLRS/N	265 kW		10/07→			
18.400 FHLC	294 kW		10/07→			
18.400 FHLS, FHLS/M	294 kW		10/07→			
18.400 FLC, FLRC, FLLC, FLLRC, FLLW, FLLW/N	294 kW		10/07→			
18.400 FLS, FLS/M, FLRS, FLRS/N, FLLS, FLLS/N, FLLRS, FLLRS/N	294 kW		10/07→			
18.440 FHLC	324 kW		10/07→			
18.440 FHLS, FHLS/M	324 kW		10/07→			
18.440 FLC, FLRC, FLLC, FLLRC, FLLW, FLLW/N	324 kW		10/07→			
18.440 FLS, FLS/M, FLRS, FLRS/M, FLLS, FLLS/N, FLLRS, FLLRS/	324 kW		10/07→			
18.480 FHLC	353 kW		10/07→			
18.480 FHLS, FHLS/M	353 kW		10/07→			
18.480 FLC, FLRC, FLLC, FLLRC, FLLW, FLLW/N	353 kW		10/07→			
18.480 FLS, FLS/M, FLRS, FLRS/N, FLLS, FLLS/N, FLLRS, FLLRS/N	353 kW		10/07→			
18.540 FHLC	397 kW		10/07→			
18.540 FHLS, FHLS/M	397 kW		10/07→			
18.540 FLC, FLRC, FLLC, FLLRC, FLLW, FLLW/N	397 kW		10/07→			
18.540 FLS, FLS/M, FLRS, FLRS/N, FLLS, FLLS/ N, FLLRS, FLLRS/N	397 kW		10/07→			
24.360 FNLLW/N	265 kW		10/07→			
24.360 FPLS, FPLRS	265 kW		10/07→			
24.400 FNLLW/N	294 kW		10/07→			
24.400 FPLS, FPLRS	294 kW		10/07→			
24.440 FNLLW/N	324 kW		10/07→			
24.440 FPLS, FPLRS	324 kW		10/07→			
24.480 FNLLW/N	353 kW		10/07→			
24.480 FPLS, FPLRS	353 kW		10/07→			
24.540 FNLLW/N	397 kW		02/09→			
24.540 FPLS, FPLRS	397 kW		10/07→			
26.320 FNLS, FNLLS	235 kW		10/07→			
26.360 FDC, FDLC, FDRC, FDLRC	265 kW		07/08→			
26.360 FDHLC	265 kW		10/07→			
26.360 FDHLS	265 kW		10/07→			
26.360 FDS, FDLS, FDRS, FDLRS	265 kW		07/08→			
26.360 FNHLC	265 kW		10/07→			
26.360 FNHLS	265 kW		12/07→			
26.360 FNLC, FNLC, FNLLC, FNLLRC, FNLLW	265 kW		10/07→			
26.360 FNLS, FNLLS, FNLRs, FNLLRS, FPLS, FPLRS, FVLS	265 kW		10/07→			
26.360 FVHLS	265 kW		05/08→			
26.400 FDC, FDLC, FDRC, FDLRC	294 kW		07/08→			
26.400 FDHLC	294 kW		10/07→			
26.400 FDHLS	294 kW		10/07→			
26.400 FDS, FDLS, FDRS, FDLRS	294 kW		07/08→			
26.400 FNHLC	294 kW		12/07→			
26.400 FNHLS	294 kW		12/07→			
26.400 FNLC, FNLC, FNLLC, FNLLRC, FNLLW	294 kW		10/07→			
26.400 FNLS, FNLLS, FNLRs, FNLLRS, FPLS, FPLRS, FVLS	294 kW		10/07→			
26.400 FPHLS	294 kW		05/08→			
26.400 FVHLS	294 kW		05/08→			

Manufacturer - Model	Power	Displ.	Year of Constr.	Remark	Part Number	Page
MAN - TGX						09/07→
26.440 FDC, FDL, FDLR, FDLRC	324 kW		07/08→	Depth [mm]: 64; + OE 81061300216; L 665 mm; Observe technical data: 1; Vers. produced by BEHR; W 892 mm	8ML 376 724-321 Intercooler, charger	595
26.440 FDHLC	324 kW		09/07→			
26.440 FDHLS	324 kW		10/07→	Depth [mm]: 64; L 892 mm; Vers. produced by BEHR; W 665 mm	8ML 376 724-371 Intercooler, charger	596
26.440 FDS, FDL, FDRS, FDLRS	324 kW		07/08→			
26.440 FNHLC	324 kW		12/07→			
26.440 FNHLS	324 kW		12/07→			
26.440 FNLC, FNLR, FNLLC, FNLLRC, FNLLW	324 kW		10/07→			
26.440 FNLS, FNLLS, FNLR, FNLLRS, FNLLRS, FPL, FPLRS, FVLS	324 kW		10/07→			
26.440 FPHLS	324 kW		05/08→			
26.440 FVHLS	324 kW		05/08→			
26.480 FDC, FDL, FDLR, FDLRC	353 kW		07/08→			
26.480 FDHLC	353 kW		09/07→			
26.480 FDHLS	353 kW		10/07→			
26.480 FDS, FDL, FDRS, FDLRS	353 kW		07/08→			
26.480 FNHLC	353 kW		12/07→			
26.480 FNHLS	353 kW		12/07→			
26.480 FNLC, FNLR, FNLLC, FNLLRC, FNLLW	353 kW		10/07→			
26.480 FNLS, FNLLS, FNLR, FNLLRS, FNLLRS, FPL, FPLRS, FVLS	353 kW		10/07→			
26.480 FPHLS	353 kW		05/08→			
26.480 FVHLS	353 kW		05/08→			
26.540 FDC, FDL, FDLR, FDLRC	397 kW		02/09→			
26.540 FDS, FDL, FDRS, FDLRS	397 kW		02/09→			
26.540 FNLC, FNLR, FNLLC, FNLLRC, FNLLW	397 kW		10/07→			
26.540 FNLS, FNLR, FNLLS, FNLR, FNLLRS, FNLLRS, FPL, FPLRS, FVLS	397 kW		10/07→			
28.360 FNLC	265 kW		10/07→			
28.360 FNLS	265 kW		10/07→			
28.400 FNLC	294 kW		10/07→			
28.400 FNLS	294 kW		10/07→			
28.440 FNLC	324 kW		10/07→			
28.440 FNLS	324 kW		10/07→			
28.480 FNLC	353 kW		10/07→			
28.480 FNLS	353 kW		10/07→			
28.540 FNLC	397 kW		10/07→			
28.540 FNLS	397 kW		02/09→			
33.360 FDC, FDL, FDLR, FDLRC	265 kW		10/07→			
33.360 FDS, FDL, FDRS, FDLRS	265 kW		10/07→			
33.400 FDC, FDL, FDLR, FDLRC	294 kW		10/07→			
33.400 FDS, FDL, FDRS, FDLRS	294 kW		10/07→			
33.440 FDC, FDL, FDLR, FDLRC	324 kW		10/07→			
33.440 FDS, FDL, FDRS, FDLRS	324 kW		10/07→			
33.480 FDC, FDL, FDLR, FDLRC	353 kW		10/07→			
33.480 FDS, FDL, FDRS, FDLRS	353 kW		10/07→			
33.540 FDC, FDL, FDLR, FDLRC	397 kW		10/07→			
33.540 FDS, FDL, FDRS, FDLRS	397 kW		10/07→			
35.360 FDNLC	265 kW		06/08→			
35.400 FDNLC	294 kW		06/08→			
35.440 FDNLC	324 kW		06/08→			
35.480 FDNLC	353 kW		06/08→			
35.540 FDNLC	397 kW		06/08→			
41.540 FVDS, FVDLS	397 kW		06/08→			

MAN	HELLA
51.09500.7129	8ML 376 756-001
81.06130.0030	8ML 376 746-311
81.06130.0051	8ML 376 723-761
81.06130.0063	8ML 376 723-761
81.06130.0073	8ML 376 723-741
81.06130.0089	8ML 376 746-311
81.06130.0098	8ML 376 746-311
81.06130.0121	8ML 376 746-311
81.06130.0170	8ML 376 724-211
81.06130.0175	8ML 376 724-211
81.06130.0176	8ML 376 724-221
81.06130.0178	8ML 376 724-221
81.06130.0179	8ML 376 724-381
81.06130.0180	8ML 376 724-321
81.06130.0190	8ML 376 733-401
81.06130.0191	8ML 376 746-301
81.06130.0192	8ML 376 728-701
81.06130.0193	8ML 376 724-431
81.06130.0195	8ML 376 724-351
81.06130.0197	8ML 376 724-381
81.06130.0198	8ML 376 724-321
81.06130.0201	8ML 376 724-351
81.06130.0203	8ML 376 724-371
81.06130.0208	8ML 376 755-451
81.06130.0209	8ML 376 724-351
81.06130.0212	8ML 376 746-301
81.06130.0215	8ML 376 724-381
81.06130.0216	8ML 376 724-321
81.06130.0217	8ML 376 724-361
81.06130.0218	8ML 376 724-371
81.06130.0220	8ML 376 755-461
81.06130.0223	8ML 376 724-351
81.06130.0225	8ML 376 755-461
81.06130.0226	8ML 376 755-451
81.06130.0228	8ML 376 728-701
81.06130.0231	8ML 376 724-381
81.06130.0232	8ML 376 724-321
81.06130.0233	8ML 376 724-361
81.06130.0234	8ML 376 724-371
81 06130 0024	8ML 376 723-761
81 06130 0082	8ML 376 724-201
81 06130 0083	8ML 376 723-741
81 06130 0084	8ML 376 723-751
81 06130 0101	8ML 376 724-201
81 06130 0102	8ML 376 723-741
81 06130 0103	8ML 376 723-751
81 06130 0128	8ML 376 724-201
81 06130 0129	8ML 376 723-741
81 06130 0130	8ML 376 723-751
81 06130 0131	8ML 376 723-761
81 06130 0181	8ML 376 724-201
81 06130 0182	8ML 376 723-741
81 06130 0183	8ML 376 723-751
81 06130 0184	8ML 376 724-431
81 06130 0199	8ML 376 724-381
81 06130 0200	8ML 376 724-371
81 0613 00204	8ML 376 724-361
81 06130 0205	8ML 376 724-371
NEOPLAN	HELLA
1107.808.0	8ML 376 724-431
1114.233.7	8ML 376 724-351
1402.262.2	8ML 376 724-431

8ML ...

8ML 376 723-741	593
8ML 376 723-751	593
8ML 376 723-761	593
8ML 376 724-201	594
8ML 376 724-211	594
8ML 376 724-221	594
8ML 376 724-321	595
8ML 376 724-351	595
8ML 376 724-361	595
8ML 376 724-371	596
8ML 376 724-381	597
8ML 376 724-431	597
8ML 376 728-701	597
8ML 376 733-401	598
8ML 376 746-301	598
8ML 376 746-311	598
8ML 376 755-451	599
8ML 376 755-461	599
8ML 376 756-001	599

8MY ...

8MY 376 744-371	599
-----------------	-----



Oil Cooler, retarder.....628

Heat Exchanger - Oil Cooler, retarder

8MO 376 765-501
BEHR HELLA SERVICE

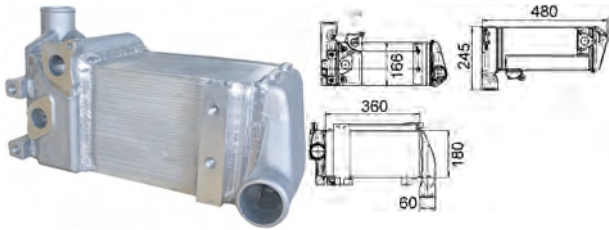

Depth [mm]	180
Length [mm]	360
Version	produced by AKG
Width [mm]	166

8MO 376 765-511
BEHR HELLA SERVICE

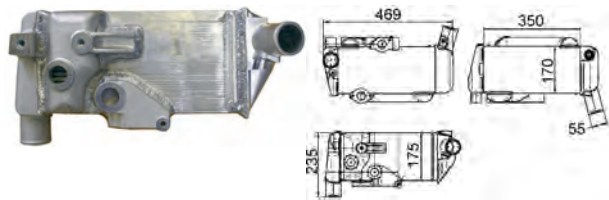

Depth [mm]	170
Length [mm]	350
Version	produced by AKG
Width [mm]	175

8MO 376 765-571
BEHR HELLA SERVICE



Depth [mm]	166
Length [mm]	360
Version	produced by AKG
Width [mm]	180



MAN.....630

Manufacturer - Model	Power	Displ.	Year of Constr.	Remark	Part Number	Page
MAN - TGA						04/00 →
18.310, 18.320 FAC, FHLC	228 - 235 kW		05/04→	Depth [mm]: 180; L 360 mm; Vers. produced by AKG; W 166 mm	8MO 376 765-501 Oil Cooler, retarder	628
18.310, 18.320 FAK, FAK-L, FALK, FALK-L, FHLK, FHLK/M	228 - 235 kW		05/04→			
18.310, 18.320 FAS, FALS, FHLS, FHLS/M	228 - 235 kW		05/04→			
18.310, 18.320 FC, FLC, FLLC, FLLC/N, FLLW, FLLW/N	228 - 235 kW		05/04→			
18.310, 18.320 FK, FK-L, FLK, FLK/M	228 - 235 kW		05/04→			
18.310, 18.320 FLS, FLRS, FLLS, FLLRS	228 - 235 kW		05/04→			
18.310, 18320 FC, FLC, FRC, FLLC, FLLC/N, FLLW, FLLRC, FLLRW	228 - 235 kW		04/00→			
18.310, 18320 FK, FLK, FK-L, FLRK	228 - 235 kW		12/00→			
18.310 FAC, FARC	228 kW		09/02→			
18.310 FAK, FAK-L, FALK	228 kW		09/02→			
18.310 FAS, FARS	228 kW		09/02→			
18.310 FLS, FLLS, FLLS/N, FLS-TS, FLRS, FLLRS	228 kW		04/00→			
18.350, 18.360 FAC, FHLC	257 - 265 kW		05/04→			
18.350, 18.360 FAK, FAK-L, FALK, FALK-L, FHLK, FHLK/M	257 - 265 kW		05/04→			
18.350, 18.360 FAS, FALS, FHLS, FHLS/M	257 - 265 kW		05/04→			
18.350, 18.360 FC, FLC, FLLC, FLLRC, FLLC/N, FLLW, FLLW/N	257 - 265 kW		05/04→			
18.350, 18.360 FK, FK-L, FLK, FLK/M,	257 - 265 kW		05/04→			
18.350 FLS, FLS/N, FLS/M, FLS-TS, FLLS, FLLS/N, FLLRS	257 kW		05/04→			
18.360 FAC, FARC	265 kW		09/02→			
18.360 FAK, FALK, FAK-L, FALK-L	265 kW		09/02→			
18.360 FAS, FALS, FARS	265 kW		09/02→			
18.360 FC, FLC, FRC, FLLC, FLLC/N, FLLW, FLLRW	265 kW		04/00→			
18.360 FK, FLK, FK-L, FLRK	265 kW		12/00→			
18.360 FLS, FLLS, FLLS/N, FLS-TS, FLRS, FLLRS	265 kW		04/00→			
18.360 FLS, FLLS, FLRS, FLLRS	265 kW		01/06→			
18.390, 18.400 FAC, FHLC	287 - 294 kW		05/04→			
18.390, 18.400 FAK, FAK-L, FALK, FALK-L, FHLK, FHLK/M	287 - 294 kW		05/04→			
18.390, 18.400 FAS, FALS, FHLS, FHLS/M	287 - 294 kW		05/04→			
18.390, 18.400 FC, FLC, FLLC, FLLC/N, FLLW, FLLW/N	287 - 294 kW		05/04→			
18.390, 18.400 FK, FK-L, FLK, FLK/M	287 - 294 kW		05/04→			
18.390 FLS, FLS-TS, FLS/M, FLLS, FLLS/N, FLLS/M, FLLRS	287 kW		05/04→			
18.400 FLS, FLLS, FLRS, FLLRS	294 kW		10/05→			
18.410, 18420 FAK, FAK-L, FALK	301 - 309 kW		09/02→			
18.410, 18420 FC, FRC, FLC, FLRC, FLLC, FLLC/N, FLLW, FLLRC	301 - 309 kW		04/00→			
18.410, 18420 FK, FK-L, FLK, FLRK	301 - 309 kW		12/00→			
18.410 FAC, FARC	301 kW		09/02→			
18.410 FAS, FALS, FARS	301 kW		09/02→			
18.410 FLS, FLLS, FLLS/N, FLS-TS, FLRS, FLLRS	301 kW		04/00→			
18.430, 18.440 FAC, FHLC	316 - 324 kW		05/04→			
18.430, 18.440 FAK, FALK, FALK-L, FHLK, FHLK/M	316 - 324 kW		05/04→			
18.430, 18.440 FAS, FALS, FHLS, FHLS/M	316 - 324 kW		05/04→			
18.430, 18.440 FC, FLC, FLLC, FLLW, FLLW/N, FLLRC, FLLRW	316 - 324 kW		05/04→			
18.430, 18.440 FK, FK-L, FLK, FLK/M	316 - 324 kW		05/04→			
18.430 FLS, FLS/M, FLS-TS, FLLS, FLLS/N, FLLRS, FLRS	316 kW		05/04→			
18.440 FLS, FLLS, FLRS, FLLRS	324 kW		09/05→			
18.460 FC, FLC, FRC, FLLC, FLLC/N, FLLW, FLLRC, FLLRW	338 kW		04/00→			
18.460 FK, FK-L, FLK, FLRK	338 kW		12/00→			
18.460 FLS, FLLS, FLLS/N, FLS-TS, FLRS, FLLRS	338 kW		04/00→			

Manufacturer - Model	Power	Displ.	Year of Constr.	Remark	Part Number	Page
MAN - TGA						04/00→
18.480 FAC	353 kW		02/06→	Depth [mm]: 180; L 360 mm; Vers. produced by AKG; W 166 mm	8MO 376 765-501 Oil Cooler, retarder	628
18.480 FAC, FARC	353 kW		09/02→			
18.480 FAK, FAK-L, FALK	353 kW		09/02→			
18.480 FAK, FALK	353 kW		02/06→			
18.480 FAS, FALS	353 kW		02/06→			
18.480 FAS, FALS, FARS	353 kW		09/02→			
18.480 FC, FLC, FLLC, FLLRC, FLLW, FLRC	353 kW		01/06→			
18.480 FC, FLC, FLLC, FLLW, FLLRW, FLLRC	353 kW		09/02→			
18.480 FHLC	353 kW		04/06→			
18.480 FHLK, FHLK/M	353 kW		04/06→			
18.480 FHLS, FHLS/M	353 kW		04/06→			
18.480 FK, FK-L, FLK	353 kW		01/06→			
18.480 FK, FLK, FK-L	353 kW		09/02→			
18.480 FLS, FLLS, FLLS/N, FLS-TS, FLRS-WW	353 kW		09/02→			
18.480 FLS, FLLS, FLRS, FLLRS	353 kW		01/06→			
18.510 FC, FLC, FRC, FLLC, FLLC/N, FLLW, FLLRC, FLLRW	375 kW		09/00→			
18.510 FLS, FLLS, FLLS/N, FLRS, FLLRS	375 kW		04/00→			
18.530 FAC	390 kW		04/04→			
18.530 FAK, FALK	390 kW		04/04→			
18.530 FAS, FALS	390 kW		04/04→			
18.530 FC, FLC, FLLC, FLLC/N, FLLW, FLLRC, FLLRW	390 kW		09/02→			
18.530 FLS, FLLS, FLLS/N	390 kW		09/02→			
18.540 FLC, FLRC, FLLC, FLLRC, FLLW	397 kW		08/06→			
18.540 FLS, FLRS, FLLS, FLLRS	397 kW		08/06→			
24.350, 24.360 FNLLC, FNLLW/N, FNLLRW	257 - 265 kW		05/04→			
24.350, 24.360 FPLS, FPLRS	257 - 265 kW		02/04→			
24.360 FNLLC/N, FNLLW, FNLLRW, FNLLRC	265 kW		09/01→			
24.390, 24.400 FNLLC/N, FNLLW/N, FNLLRC, FNLLRW	287 - 294 kW		05/04→			
24.390, 24.400 FPLS, FPLRS	287 - 294 kW		05/04→			
24.410 FNLLC/N, FNLLW, FNLLRW	301 kW		09/01→			
24.430, 24.440 FNLLC/N, FNLR, FNLLW	316 - 324 kW		05/04→			
24.430, 24.440 FPLS, FPLRS	316 - 324 kW		05/04→			
24.460 FNLLC/N, FNLLW, FNLLRC, FNLLRW	338 kW		09/01→			
24.480 FNLLC/N, FNLLW, FNLLRC, FNLLRW	353 kW		09/02→			
24.480 FNLLC/N, FNLLW/N	353 kW		01/06→			
24.480 FPLS, FPLRS	353 kW		07/05→			
24.480 FPLS, FPLRS	353 kW		01/06→			
24.510 FNLLC/N, FNLLW, FNLLRW	375 kW		09/01→			
24.530 FNLLC/N, FNLLW, FNLLRW	390 kW		09/01→			
24.530 FPLS, FPLRS	390 kW		07/05→			
24.540 FNLLC/N, FLLCW/N	397 kW		01/06→			
26.280 FNLC, FNLLC, FNLLW	206 kW		11/02→			
26.310, 26.320 FDC, FDRC, FDC/M, FDRC/M, FDLC, FNHLC, FVHLC	228 - 235 kW		05/04→			
26.310, 26.320 FDH, FDHC, FDHC/M	228 - 235 kW		06/05→			
26.310, 26.320 FDHK	228 - 235 kW		06/05→			
26.310, 26.320 FDHS, FDHS/M	228 - 235 kW		06/05→			
26.310, 26.320 FDH-TM	228 - 235 kW		06/05→			
26.310, 26.320 FDK, FDLK	228 - 235 kW		05/04→			
26.310, 26.320 FDS, FDS/M, FDLS, FDRS, FDRS/M, FNHLS, FDLRS	228 - 235 kW		05/04→			
26.310, 26.320 FD-TM	228 - 235 kW		06/05→			
26.310, 26.320 FNLC, FNLLC, FNLR, FNLLRC, FNLLW	228 - 235 kW		05/04→			
26.310, 26.320 FNLS, FNLLS, FNLR, FNLLRS	228 - 235 kW		05/04→			
26.310, 26.320 FVHL-KO	228 - 235 kW		06/05→			
26.310, 26.320 FVLC	228 - 235 kW		02/04→			
26.310, 26.320 FVL-KO	228 - 235 kW		02/04→			
26.310 FDAC	228 kW		01/04→			
26.310 FDAC, FDARC	228 kW		02/02→			
26.310 FDAK	228 kW		02/02→			

Manufacturer - Model	Power	Displ.	Year of Constr.	Remark	Part Number	Page
MAN - TGA						04/00→
26.310 FDAK	228 kW		01/04→	Depth [mm]: 180; L 360 mm; Vers. produced by AKG; W 166 mm	8MO 376 765-501 Oil Cooler, retarder	628
26.310 FDAS	228 kW		01/04→			
26.310 FDAS, FDARS	228 kW		02/02→			
26.310 FDC, FDLC, FDRC, FDLC/M, FDLRC	228 kW		01/01→			
26.310 FDK, FDLK, FDRK	228 kW		09/02→			
26.310 FDS, FDLS, FDLS/M, FDLRS	228 kW		01/01→			
26.310 FD-TM, FDR-TM	228 kW		10/00→			
26.310 FNLC, FNLLC, FVLC, FNLLW, FNLRC, FNLLRW	228 kW		09/00→			
26.310 FPLS, FVLS, FNLS, FNLLS, FPLRS, FNLRS, FVLRS	228 kW		12/00→			
26.310 FVLC	228 kW		09/03→			
26.310 FVL-KO	228 kW		12/00→			
26.320 FDAC	235 kW		04/06→			
26.320 FDAK	235 kW		04/06→			
26.320 FDAS	235 kW		04/06→			
26.330 FNLC, FNLLC, FNLLW	240 kW		11/02→			
26.350, 26.360 FDC, FDRC, FDC/M, FDRC/M, FDLC, FDLRC, FNHLC	257 - 265 kW		05/04→			
26.350, 26.360 FDHK, FDHLK	257 - 265 kW		05/04→			
26.350, 26.360 FDHS, FDHS/M, FDHLS	257 - 265 kW		05/04→			
26.350, 26.360 FDH-TM	257 - 265 kW		05/04→			
26.350, 26.360 FDK, FDLK, FDRK	257 - 265 kW		05/04→			
26.350, 26.360 FDS, FDS/M, FDLS, FDRS, FNHLS, FPHLS	257 - 265 kW		05/04→			
26.350, 26.360 FD-TM	257 - 265 kW		02/04→			
26.350, 26.360 FNLC, FNLLC, FNLLW, FNLRC, FNLLRC	257 - 265 kW		05/04→			
26.350, 26.360 FNLS, FNLLS, FNLRS, FNLLRS, FPLS, FPLRS	257 - 265 kW		05/04→			
26.350, 26.360 FVHL-KO	257 - 265 kW		06/05→			
26.350, 26.360 FVL-KO	257 - 265 kW		01/04→			
26.350 FDAC	257 kW		02/04→			
26.350 FDAK	257 kW		02/04→			
26.350 FDAS	257 kW		02/04→			
26.350 FDHC, FDHC/M	257 kW		04/05→			
26.350 FDLRC-WW	257 kW		05/04→			
26.350 FDLS, FDLRS, FDLRS/M, FDLRS-WW	257 kW		05/04→			
26.350 FVHLC	257 kW		06/05→			
26.350 FVHLS	257 kW		07/05→			
26.350 FVLC	257 kW		01/04→			
26.350 FVLS, FVLRS	257 kW		07/05→			
26.360 FDAC, FDARC	265 kW		02/02→			
26.360 FDAC, FDARC	265 kW		06/04→			
26.360 FDAK, FDALK	265 kW		02/02→			
26.360 FDAK, FDARK	265 kW		06/04→			
26.360 FDAS, FDARS	265 kW		02/02→			
26.360 FDAS, FDARS	265 kW		06/04→			
26.360 FDC, FDLC, FDLC/M, FDRC, FDLRC-WW	265 kW		01/01→			
26.360 FDHC, FDHLC	265 kW		05/04→			
26.360 FDK, FDLK, FDRK, FDLRK	265 kW		09/02→			
26.360 FDLC-WW, FDLRC	265 kW		05/04→			
26.360 FDLS, FDLRS-WW, FNHLS	265 kW		05/04→			
26.360 FDLS, FDLS/M, FDLRS, FDLRS/M, FDLRS-WW, FDRS	265 kW		09/03→			
26.360 FDS, FDLS, FNLS, FNLLS, FPLS, FPLRS, FVLS, FVLRS	265 kW		12/00→			
26.360 FD-TM, FDR-TM	265 kW		01/01→			
26.360 FNLC, FNLLC, FNLLW, FNLLRC, FNLLRW, FVLC	265 kW		09/00→			
26.360 FVHLC	265 kW		04/06→			
26.360 FVHLS	265 kW		04/06→			
26.360 FVLC	265 kW		04/06→			
26.360 FVL-KO	265 kW		12/00→			
26.360 FVLS, FVLRS	265 kW		04/06→			
26.390, 26.400 FDC, FDRC, FDLRC, FDRC/M, FDLC, FNHLC, FVHLC	287 - 294 kW		05/04→			
26.390, 26.400 FDHC, FDHC/M, FDHLC	287 - 294 kW		06/05→			
26.390, 26.400 FDHK, FDHLK	287 - 294 kW		06/05→			

Manufacturer - Model	Power	Displ.	Year of Constr.	Remark	Part Number	Page
MAN - TGA						04/00→
26.390, 26.400 FDHS, FDHS/M, FDHLS	287 - 294 kW		06/05→	Depth [mm]: 180; L 360 mm; Vers. produced by AKG; W 166 mm	8MO 376 765-501 Oil Cooler, retarder	628
26.390, 26.400 FDK, FDLK	287 - 294 kW		05/04→			
26.390, 26.400 FDS, FDS/M, FDLS, FDLRS, FNHLS, FPHLS, FVHLS	287 - 294 kW		05/04→			
26.390, 26.400 FD-TM	287 - 294 kW		05/04→			
26.390, 26.400 FNLC, FNLLC, FNLLW, FNLR, FNLLRC	287 - 294 kW		05/04→			
26.390, 26.400 FNLS, FNLLS, FNLR, FNLLRS, FPLS, FPLRS	287 - 294 kW		05/04→			
26.390, 26.400 FVHL-KO	287 - 294 kW		06/05→			
26.390, 26.400 FVL-KO	287 - 294 kW		02/04→			
26.390 FDAC, FDALC	287 kW		01/04→			
26.390 FDAK, FDALK	287 kW		02/04→			
26.390 FDAS, FDALS	287 kW		02/04→			
26.390 FDH-TM	287 kW		06/05→			
26.390 FVLC	287 kW		02/04→			
26.390 FVLS, FVLRS	287 kW		07/05→			
26.400 FDAC, FDALC	294 kW		01/04→			
26.400 FDAK, FDALK	294 kW		01/04→			
26.400 FDAS, FDALS	294 kW		01/04→			
26.400 FDH-TM	294 kW		04/06→			
26.400 FVLC	294 kW		04/06→			
26.400 FVLS, FVLRS	294 kW		04/06→			
26.410 FDAC, FDARC	301 kW		02/02→			
26.410 FDAK, FDALK	301 kW		02/02→			
26.410 FDAS, FDALS, FDARS	301 kW		02/02→			
26.410 FDC, FDLC, FDLC/M, FDLC-WW; FDR, FDR, FDLRC-WW	301 kW		01/01→			
26.410 FDK, FDR, FDLK, FDLRC	301 kW		09/01→			
26.410 FDS, FDLS, FDLS/M, FDLS-WW, FDRS-WW, FDLRS-WW	301 kW		06/01→			
26.410 FD-TM, FDR-TM	301 kW		01/01→			
26.410 FNLC, FNLLC, FNLLW, FNLR, FNLLRC, FVLC	301 kW		04/00→			
26.410 FPLS, FPLRS, FVLS, FNLS, FNLLS	301 kW		12/00→			
26.410 FVLC	301 kW		09/03→			
26.410 FVL-KO	301 kW		12/00→			
26.410 FVLS, FVLRS	301 kW		07/05→			
26.430, 26.440, FNLC, FNLLC, FNLLW, FNLR, FNLLRC, FVLC	316 - 324 kW		05/04→			
26.430, 26.440, FNLS, FNLLS, FNLR, FNLLRS, FPLS, FPLRS	316 - 324 kW		05/04→			
26.430, 26.440 FDC, FDR, FDLC, FDLRC, FDLC/M, FNHLC, FVHLC	316 - 324 kW		05/04→			
26.430, 26.440 FDHC, FDHC/M, FDHLC	316 - 324 kW		06/05→			
26.430, 26.440 FDHK, FDHLK	316 - 324 kW		06/05→			
26.430, 26.440 FDHS, FDHS/M, FDHLS	316 - 324 kW		06/05→			
26.430, 26.440 FDH-TM	316 - 324 kW		06/05→			
26.430, 26.440 FDK, FDLK	316 - 324 kW		05/04→			
26.430, 26.440 FDS, FDLS, FDR, FDLRS, FNHLS, FPHLS, FVHLS	316 - 324 kW		02/04→			
26.430, 26.440 FD-TM	316 - 324 kW		05/04→			
26.430, 26.440 FVLH-KO	316 - 324 kW		06/05→			
26.430 FDAC, FDALC	316 kW		01/04→			
26.430 FDAK, FDALK	316 kW		01/04→			
26.430 FDAS, FDALS	316 kW		01/04→			
26.430 FDLS, FDLS/M, FDLRS-WW	316 - 324 kW		02/04→			
26.430 FVL-KO	316 kW		12/00→			
26.430 FVLS, FVLRS	316 kW		07/05→			
26.440 FDAC, FDALC	324 kW		09/05→			
26.440 FDAK, FDALK	324 kW		01/04→			
26.440 FDAS, FDALS	324 kW		01/04→			
26.440 FDLC-WW, FDLRC-WW	324 kW		02/06→			
26.440 FDS, FDLS, FDLS-WW, FDLRS-WW	324 kW		02/06→			
26.440 FVL-KO	324 kW		09/05→			
26.440 FVLS, FVLRS	324 kW		09/05→			
26.460 FDC, FDLC, FDLC/M, FDLC-WW, FDR, FDLRC-WW	338 kW		01/01→			
26.460 FDK, FDLK, FDLRC	338 kW		01/01→			

Manufacturer - Model	Power	Displ.	Year of Constr.	Remark	Part Number	Page
MAN - TGA						04/00→
26.460 FDS, FDLS, FDLRS/M, FDLS-WW, FDRS-WW, FDLRS- WW	338 kW		06/01→	Depth [mm]: 180; L 360 mm; Vers. produced by AKG; W 166 mm	8MO 376 765-501 Oil Cooler, retarder	628
26.460 FD-TM, FDR-TM	338 kW		01/01→			
26.460 FNLC, FNLC, FNLLC, FNLLRW, FNLLRC	338 kW		04/00→			
26.460 FPLS, FPLRS, FVLS, FVLR, FNLS, FNLLS, FNLR	338 kW		12/00→			
26.460 FVLC	338 kW		02/01→			
26.460 FVL-KO	338 kW		12/00→			
26.480 FDAC, FDALC	353 kW		02/06→			
26.480 FDAC, FDALC, FDARC	353 kW		09/02→			
26.480 FDAK, FDALK	353 kW		09/02→			
26.480 FDAK, FDALK	353 kW		02/06→			
26.480 FDAS, FDALS	353 kW		02/06→			
26.480 FDAS, FDALS, FDARS	353 kW		09/02→			
26.480 FDC, FDC/M, FDLC, FDLRC, FDR, FNHLC, FVHLC, FDLRC-WW	353 kW		02/06→			
26.480 FDC, FDLC, FDR, FDLC/M, FDLRC-WW	353 kW		09/02→			
26.480 FDHC, FDHC/M, FDHLC	353 kW		02/06→			
26.480 FDHK, FDHLK	353 kW		02/06→			
26.480 FDHS, FDHS/M, FDHLS	353 kW		02/06→			
26.480 FDH-TM	353 kW		02/06→			
26.480 FDK, FDLK	353 kW		02/06→			
26.480 FDK, FDLK, FDLRK	353 kW		09/02→			
26.480 FDS, FDLS, FDLRS, FNHLS, FPHLS, FVHLS	353 kW		02/06→			
26.480 FDS, FDLS, FDLRS/M, FDLRS-WW, FDRS	353 kW		09/02→			
26.480 FD-TM	353 kW		09/02→			
26.480 FD-TM	353 kW		02/06→			
26.480 FNLC, FNLLC, FVLC, FNLLRC, FVLLW	353 kW		09/02→			
26.480 FNLC, FNLC-WW, FNLLC, FNLLRC, FNLLW, FVLC	353 kW		02/06→			
26.480 FNLS, FNLLS, FNLR, FPLS, FVLS	353 kW		09/02→			
26.480 FNLS, FNLLS, FNLR, FPLS, FVLS, FVLR	353 kW		02/06→			
26.480 FVHL-KO	353 kW		02/06→			
26.480 FVL-KO	353 kW		09/02→			
26.480 FVL-KO	353 kW		01/06→			
26.510 FDC, FDC/M, FDR, FDLC, FDLC/M, FDLRC	375 kW		01/01→			
26.510 FDS, FDLS, FDLRS/M, FDR, FDLRS	375 kW		01/01→			
26.510 FNLC, FNLLC, FNLLW, FNLLRC, FVLC	375 kW		12/00→			
26.510 FNLS, FNLLS, FNLR, FPLS, FVLS	375 kW		12/00→			
26.530 FDAC, FDALC	390 kW		07/06→			
26.530 FDAK, FDALK	390 kW		09/02→			
26.530 FDAS, FDALS	390 kW		07/06→			
26.530 FDC, FDLC, FDC/M, FDLRC	390 kW		01/01→			
26.530 FDK, FDLK, FDLRK	390 kW		09/02→			
26.530 FDS, FDLS, FDLRS/M, FDLRS	390 kW		01/01→			
26.530 FNLC, FNLLC, FNLLW, FNLLRC, FVLC, FVLR	390 kW		09/02→			
26.530 FNLS, FNLLS, FNLR, FPLS, FVLS, FVLR	390 kW		09/02→			
26.540 FNLC, FNLLC, FNLLRC, FNLLW	397 kW		08/06→			
27.440 FDS, FDLS, FDR, FDLRS	324 kW		10/08→			
28.310, 28.320 FNLC, FNLLC, FNLL-LE, FNLLR-LE	228 - 235 kW		07/06→			
28.310, 28.320 FNLC, FNLLC, FNLLRC, FNLLR-LE	228 - 235 kW		07/06→			
28.310 FNLC, FNLLC	228 kW		09/02→			
28.310 FNLC, FNLLC, FNLR	228 kW		09/02→			
28.310 FNLS, FNLR	228 kW		09/02→			
28.310 FNLS, FNLR	228 kW		06/04→			
28.320 FNLC, FNLLC, FNLR	235 kW		06/04→			
28.320 FNLS, FNLR	235 kW		06/04→			
28.350, 28.360 FNLC, FNLLC, FNLL-LE	257 - 265 kW		07/06→			

Manufacturer - Model	Power	Displ.	Year of Constr.	Remark	Part Number	Page
MAN - TGA						04/00→
28.350, 28.360 FNLC, FNLLC, FNLR, FNLL-LE	257 - 265 kW		06/04→	Depth [mm]: 180; L 360 mm; Vers. produced by AKG; W 166 mm	8MO 376 765-501 Oil Cooler, retarder	628
28.350 FANLC	257 kW		07/06→			
28.350 FANLK	257 kW		07/06→			
28.350 FNLS, FNLR-ww	257 kW		02/04→			
28.360 FANLC	265 kW		07/06→			
28.360 FANLK	265 kW		07/06→			
28.360 FNLC, FNLLC	265 kW		09/02→			
28.360 FNLS, FNLR	265 kW		09/02→			
28.360 FNLS, FNLR-ww	265 kW		04/06→			
28.390, 28.400 FNLC, FNLLC, FNLR-ww	287 - 294 kW		06/04→			
28.390 FANLC	287 kW		07/06→			
28.390 FANLK	287 kW		07/06→			
28.390 FNLLC	353 kW		07/06→			
28.390 FNLS, FNLR	287 kW		05/04→			
28.400 FANLC	294 kW		07/06→			
28.400 FANLK	294 kW		07/06→			
28.400 FNLS, FNLR	294 kW		04/06→			
28.410 FANLC	301 kW		07/06→			
28.410 FANLK	301 kW		07/06→			
28.410 FNLC, FNLLC	301 kW		09/02→			
28.410 FNLC, FNLLC, FNLR	301 kW		09/02→			
28.410 FNLS, FNLR	301 kW		09/02→			
28.430, 28.440 FNLC, FNLLC, FNLR-ww	316 - 324 kW		06/04→			
28.430 FANLC	316 kW		07/06→			
28.430 FANLK	316 kW		07/06→			
28.430 FNLS, FNLR-ww	316 kW		05/04→			
28.440 FANLC	324 kW		07/06→			
28.440 FANLK	324 kW		07/06→			
28.440 FNLS, FNLR-ww	324 kW		09/05→			
28.460 FNLC, FNLLC, FNLR	338 kW		09/02→			
28.460 FNLS, FNLR	338 kW		09/02→			
28.480 FANLC	353 kW		07/06→			
28.480 FANLK	353 kW		07/06→			
28.480 FNLC, FNLLC, FNLR	353 kW		09/02→			
28.480 FNLC, FNLR-ww, FNLLC	353 kW		02/06→			
28.480 FNLS, FNLR	353 kW		09/02→			
28.480 FNLS, FNLR-ww	353 kW		02/06→			
28.510 FNLC, FNLLC, FNLR	375 kW		09/02→			
28.510 FNLS, FNLR	375 kW		09/02→			
28.530 FANLC	390 kW		07/06→			
28.530 FANLK	390 kW		07/06→			
28.530 FNLC, FNLLC, FNLR	390 kW		09/02→			
28.530 FNLS, FNLR	390 kW		09/02→			
28.540 FNLC, FNLLC	397 kW		08/06→			
28.540 FNLS	397 kW		08/06→			
32.310 FFDLC, FFDLC, FFDLC	228 kW		01/02→			
32.310 FFDK, FFDK	228 kW		01/02→			
33.350, 33.360 FDAC, FDHC, FDHC/M	257 - 265 kW		06/05→			
33.350, 33.360 FDAK, FDHK	257 - 265 kW		06/05→			
33.350, 33.360 FDAS, FDHS, FDHS/M	257 - 265 kW		06/05→			
33.350, 33.360 FDC, FDC/M, FDLC, FDRC	257 - 265 kW		05/04→			
33.350, 33.360 FDK, FDLK, FDRK	257 - 265 kW		05/04→			
33.350, 33.360 FDS, FDLS, FDS/M, FDRS	257 - 265 kW		05/04→			
33.350 FDC-TM, FDRC-TM	257 kW		09/07→			
33.360 FDAC, FDARC, FDAC-ww	265 kW		09/02→			
33.360 FDAK, FDAK-ww	265 kW		09/02→			
33.360 FDAS, FDAS-ww	265 kW		09/02→			
33.360 FDC, FDC-ww, FDLC/M, FDRC-ww, FDLRC	265 kW		10/00→			
33.360 FDC-TM, FDRC-TM	265 kW		09/07→			
33.360 FDK, FDK-ww, FDLK, FDRK-ww	265 kW		01/01→			
33.360 FDS, FDS-ww, FDLS, FDLRS, FDRS-ww	265 kW		10/00→			
33.360 FD-TM, FDR-TM	265 kW		01/01→			
33.390, 33.400 FDAC, FDHC, FDHC/M	287 - 295 kW		06/05→			
33.390, 33.400 FDAK, FDHK	287 - 295 kW		06/05→			
33.390, 33.400 FDAS, FDHS, FDHS/M	287 - 295 kW		06/05→			

Manufacturer - Model	Power	Displ.	Year of Constr.	Remark	Part Number	Page
MAN - TGA						04/00→
33.390, 33.400 FDC, FDLC, FDR, FDC/M	287 - 294 kW		05/04→	Depth [mm]: 180; L 360 mm; Vers. produced by AKG; W 166 mm	8MO 376 765-501 Oil Cooler, retarder	628
33.390, 33.400 FDC-TM, FDR-TM	287 - 294 kW		09/07→			
33.390, 33.400 FDK, FDLK, FDRK	287 - 294 kW		05/04→			
33.390, 33.400 FDS, FDLS, FDLRS, FDRS, FDS/M	287 - 294 kW		05/04→			
33.410 FDAC, FDAC-WW, FDALC	301 kW		09/02→			
33.410 FDAK, FDAK-WW, FDALK	301 kW		09/02→			
33.410 FDAS, FDAS-WW, FDALS	301 kW		09/02→			
33.410 FDC, FDC-WW, FDL, FDLRC, FDR, FDR-WW	301 kW		10/00→			
33.410 FDK, FDK-WW, FDLK, FDRK-WW	301 kW		10/00→			
33.410 FDS, FDS-WW, FDLS, FDLS/M, FDLRS, FDRS-WW	301 kW		10/00→			
33.410 FD-TM, FDR-TM	301 kW		10/00→			
33.430, 33.440 FDAC, FDALC, FDHC, FDHC/M	316 - 324 kW		06/05→			
33.430, 33.440 FDAK, FDALK, FDHK	316 - 324 kW		06/05→			
33.430, 33.440 FDAS, FDALS, FDHS	316 - 324 kW		06/05→			
33.430, 33.440 FDC, FDLC, FDR, FDLRC, FDC/M	316 - 324 kW		05/04→			
33.430, 33.440 FDK, FDLK, FDRK	316 - 324 kW		05/04→			
33.430, 33.440 FDS, FDLS, FDRS, FDLRS, FDS/M	316 - 324 kW		05/04→			
33.440 FDAC, FDHC	324 kW		06/05→			
33.440 FDAK, FDHK	324 kW		06/05→			
33.440 FDAS, FDHS	324 kW		06/05→			
33.440 FDC, FDR	324 kW		06/05→			
33.440 FDC-TM, FDR-TM	324 kW		09/07→			
33.440 FDK, FDRK	324 kW		06/05→			
33.440 FDS, FDRS	324 kW		06/05→			
33.460 FDAC-WW	338 kW		09/02→			
33.460 FDAK-WW	338 kW		09/02→			
33.460 FDAS-WW	338 kW		09/02→			
33.460 FDC, FDC-WW, FDL, FDLRC, FDR, FDR-WW	338 kW		09/02→			
33.460 FDK, FDK-WW, FDLK, FDRK-WW	338 kW		09/02→			
33.460 FDS, FDLS, FDLS/M, FDLRS, FDRS-WW	338 kW		09/02→			
33.460 FD-TM, FDR-TM	338 kW		09/02→			
33.480 FDAC, FDAC-WW, FDALC, FDARC	353 kW		09/02→			
33.480 FDAC, FDALC, FDHC, FDHC/M	353 kW		02/06→			
33.480 FDAK, FDAK-WW, FDALK	353 kW		09/02→			
33.480 FDAK, FDALK, FDHK	353 kW		02/06→			
33.480 FDAS, FDALS, FDHS	353 kW		02/06→			
33.480 FDAS, FDAS-WW, FDARS, FDALS	353 kW		09/02→			
33.480 FDC, FDC-WW, FDL, FDLRC, FDR, FDR-WW	353 kW		09/02→			
33.480 FDC, FDLC, FDR, FDC/M	353 kW		01/06→			
33.480 FDC-TM, FDR-TM	353 kW		09/07→			
33.480 FDK, FDK-WW, FDLK, FDRK-WW	353 kW		09/02→			
33.480 FDK, FDLK, FDRK	353 kW		01/06→			
33.480 FDS, FDRS, FDLS, FDS/M	353 kW		01/06→			
33.480 FDS, FDS-WW, FDLS, FDLS/M, FDRS-WW, FDLRS	353 kW		09/02→			
33.480 FD-TM	353 kW		09/02→			
33.510 FDC, FDC/M, FDLC, FDR, FDLRC	375 kW		09/02→			
33.510 FDS, FDLS/M, FDRS, FDLRS/M	375 kW		09/02→			
33.530 FDAC, FDALC	390 kW		09/02→			
33.530 FDAK, FDALK	390 kW		09/02→			
33.530 FDAS, FDALS	390 kW		09/02→			

Manufacturer - Model	Power	Displ.	Year of Constr.	Remark	Part Number	Page			
MAN - TGA						04/00 →			
33.530 FDC, FDC/M, FDL, FDLRC, FDLRC	390 kW		09/02→	Depth [mm]: 180; L 360 mm; Vers. produced by AKG; W 166 mm	8MO 376 765-501 Oil Cooler, retarder	628			
33.530 FDK, FDLK	390 kW		07/03→						
33.530 FDS, FDLS, FDLS/M, FDRS, FDLRS	390 kW		07/03→						
35.530 FFDK, FFDLK	390 kW		04/04→						
35.530 FFNLC	390 kW		07/06→						
39.390 FVNLC	287 kW		07/06→						
39.400 FVNLC	294 kW		07/06→						
39.430 FVNLC	316 kW		07/06→						
39.440 FVNLC	324 kW		07/06→						
39.480 FVNLC	353 kW		07/06→						
40.390, 40.400 FDAK-WW	287 - 294 kW		06/05→						
40.390, 40.400 FDAS-WW	287 - 294 kW		06/05→						
40.390, 40.400 FDK-WW, FDRK	287 - 294 kW		06/05→						
40.390, 40.400 FDS-WW, FDRS	287 - 294 kW		06/05→						
40.410 FDAK-WW	301 kW		04/04→						
40.410 FDAS-WW	301 kW		04/04→						
40.410 FDK-WW	301 kW		04/04→						
40.410 FDS-WW	301 kW		04/04→						
40.430, 40.440 FDAK-WW	316 - 324 kW		06/05→						
40.430, 40.440 FDAS-WW	316 - 324 kW		06/05→						
40.430 FDK-WW, FDRK	316 kW		06/05→						
40.430 FDS-WW, FDRS	316 kW		06/05→						
40.440 FDAK-WW	324 kW		06/05→						
40.440 FDAS-WW	324 kW		06/05→						
40.440 FDK-WW, FDRK	324 kW		06/05→						
40.440 FDS-WW, FDRS	324 kW		06/05→						
40.460 FDAK-WW	338 kW		04/04→						
40.460 FDAS-WW	338 kW		04/04→						
40.460 FDK-WW	338 kW		04/04→						
40.460 FDS-WW	338 kW		04/04→						
40.480 FDAK-WW	353 kW		04/04→						
40.480 FDK-WW	353 kW		06/05→						
40.480 FDAS-WW	353 kW		04/04→						
40.480 FDAS-WW	353 kW		06/05→						
40.480 FDK-WW	353 kW		04/04→						
40.480 FDK-WW, FDRK	353 kW		06/05→						
40.480 FDS-WW	353 kW		04/04→						
40.480 FDS-WW, FDRS	353 kW		06/05→						
32.310 FFD-TM	228 kW		01/02→				Depth [mm]: 180; L 360 mm; Vers. produced by AKG; W 166 mm	8MO 376 765-501 Oil Cooler, retarder	628
32.350, 32.360 FFDRC	257 - 265 kW		05/04→						
32.350, 32.360 FFD-TM, FFDRC-TM	257 - 265 kW		02/04→	Depth [mm]: 166; L 360 mm; Vers. produced by AKG; W 180 mm	8MO 376 765-571 Oil Cooler, retarder	628			
32.360 FFDK, FFDLC, FFDLRC	265 kW		01/02→						
32.360 FFDK, FFDLK	265 kW		01/02→						
32.360 FFD-TM	265 kW		01/02→						
32.390, 32.400 FFDRC	287 - 294 kW		05/04→						
32.390, 32.400 FFD-TM, FFDRC-TM	287 - 294 kW		05/04→						
32.410 FFDK, FFDLC, FFDRC, FFDLRC	301 kW		01/02→						
32.410 FFDK, FFDLK	301 kW		01/02→						
32.410 FFD-TM	301 kW		01/02→						
32.430, 32.440 FFDRC	316 - 324 kW		05/04→						
32.430, 32.440 FFD-TM, FFDRC-TM	316 - 324 kW		05/04→						
32.460 FFDK, FFDLC, FFDLRC	338 kW		01/02→						
32.460 FFDK, FFDLK	338 kW		01/02→						
32.460 FFD-TM	338 kW		01/02→						
32.480 FFDK, FFDLC, FFDLRC	353 kW		09/02→						
32.480 FFDK, FFDLK	353 kW		09/02→						
32.480 FFDRC	353 kW		02/06→						
32.480 FFD-TM	353 kW		09/02→						
32.480 FFD-TM, FFDRC-TM	353 kW		02/06→						
35.310, 35.320 FFDK, FFDLC	228 - 235 kW		02/04→						
35.310, 35.320 FFDK, FFDLK	228 - 235 kW		02/04→						
35.310, 35.320 FFD-TM	228 - 235 kW		02/04→						
35.310 FFDK, FFDLK	228 kW		06/03→						
35.310 FFD-TM	228 kW		11/03→						
35.350, 35.360 FFDK, FFDRC, FFDLC	257 - 265 kW		02/04→						
35.350, 35.360 FFDK, FFDRC, FFDLK	257 - 265 kW		02/04→						
35.350, 35.360 FFD-TM	257 - 265 kW		02/04→						
35.350 FFDHK, FFDHLK	257 kW		07/06→						
35.350 FFDH-TM	257 kW		07/06→						
35.350 FFNLC	257 kW		07/06→						
35.360 FFDHK, FFDHLK	265 kW		07/06→						
35.360 FFDH-TM	265 kW		07/06→						
35.360 FFNHLK	265 kW		07/06→						

Manufacturer - Model	Power	Displ.	Year of Constr.	Remark	Part Number	Page
MAN - TGA						04/00 →
35.360 FFNLC	265 kW		07/06→	Depth [mm]: 180; L 360 mm; Vers. produced by AKG; W 166 mm	8MO 376 765-501 Oil Cooler, retarder	628
35.390, 35.400 FFDC, FFDRC, FFDLC	287 - 294 kW		02/04→			
35.390, 35.400 FFDK, FFDRC, FFDLK	287 - 294 kW		02/04→	Depth [mm]: 166; L 360 mm; Vers. produced by AKG; W 180 mm	8MO 376 765-571 Oil Cooler, retarder	628
35.390, 35.400 FFD-TM	287 - 294 kW		02/04→			
35.390 FDNLC	287 kW		07/06→			
35.390 FFDAK	287 kW		02/04→			
35.390 FFDAK, FFDHK, FFDHLK	287 kW		07/06→			
35.390 FFDH-TM	287 kW		07/06→			
35.390 FFNLC	287 kW		07/06→			
35.400 FDNLC	294 kW		07/06→			
35.400 FFDAK	294 kW		02/04→			
35.400 FFDAK, FFDHK, FFDHLK	294 kW		07/06→			
35.400 FFDH-TM	294 kW		07/06→			
35.400 FFNHLC	294 kW		11/06→			
35.400 FFNLC	294 kW		07/06→			
35.410 FDNLC	301 kW		07/06→			
35.410 FFDAK	301 kW		07/06→			
35.410 FFDC, FFDLC	301 kW		10/03→			
35.410 FFDK, FFDLK	301 kW		10/03→			
35.410 FFD-TM	301 kW		11/03→			
35.410 FFNLC	301 kW		07/06→			
35.430, 35.440 FFDC, FFDRC, FFDLC	316 - 324 kW		02/04→			
35.430, 35.440 FFDK, FFDRC, FFDLK	316 - 324 kW		02/04→			
35.430, 35.440 FFD-TM	316 - 324 kW		02/04→			
35.430 FDNLC	316 kW		07/06→			
35.430 FFDAK, FFDHK, FFDHLK	316 kW		07/06→			
35.430 FFDH-TM	316 kW		07/06→			
35.430 FFNLC	316 kW		07/06→			
35.440 FDNLC	324 kW		07/06→			
35.440 FFDAK, FFDHK, FFDHLK	324 kW		07/06→			
35.440 FFDH-TM	324 kW		07/06→			
35.440 FFNHLC	324 kW		11/06→			
35.440 FFNLC	324 kW		07/06→			
35.460 FFDC, FFDLC	338 kW		10/03→			
35.460 FFD-TM	338 kW		11/03→			
35.460 FFNLC	338 kW		07/06→			
35.480 FFDAK	353 kW		07/06→			
35.480 FFDAK, FFDHK, FFDHLK	353 kW		07/06→			
35.480 FFDARS	353 kW		07/06→			
35.480 FFDC, FFDLC	353 kW		10/03→			
35.480 FFDC, FFDLC	353 kW		02/04→			
35.480 FFDH-TM	353 kW		07/06→			
35.480 FFDK, FFDLK	353 kW		10/03→			
35.480 FFDK, FFDLK	353 kW		02/04→			
35.480 FFD-TM	353 kW		11/03→			
35.480 FFD-TM	353 kW		02/04→			
35.480 FFNHLC	353 kW		11/06→			
35.480 FFNLC	353 kW		07/06→			
35.530 FDNLC	390 kW		04/04→			
35.530 FFDAK	390 kW		07/06→			
35.530 FFDC, FFDLC	390 kW		04/04→			
35.310 FFDC, FFDLC	228 kW		06/03→	Depth [mm]: 180; L 360 mm; Vers. produced by AKG; W 166 mm	8MO 376 765-501 Oil Cooler, retarder	628
35.360 FFDC, FFDLC	265 kW		10/03→			
35.360 FFDK, FFDLK	265 kW		10/03→	Depth [mm]: 170; L 350 mm; Vers. produced by AKG; W 175 mm	8MO 376 765-511 Oil Cooler, retarder	628
35.360 FFD-TM	265 kW		11/03→			
35.460 FFDK, FFDLK	338 kW		10/03→	Depth [mm]: 166; L 360 mm; Vers. produced by AKG; W 180 mm	8MO 376 765-571 Oil Cooler, retarder	628
35.480 FDNLC	353 kW		07/06→			
35.530 FFD-TM	390 kW		04/04→			
41.350, 41.360 FFDC, FFDRC/M, FFDRC	257 - 265 kW		12/04→			
41.350, 41.360 FFDK, FFDRC	257 - 265 kW		12/04→			
41.350, 41.360 FFD-TM	257 - 265 kW		12/04→			
41.350 FFDC-TM, FFDRC-TM	257 kW		09/07→			
41.360 FFD	265 kW		12/08→			
41.360 FFDC, FFDRC/M, FFDRC-M-WW, FFDRC	265 kW		01/03→			
41.360 FFDC-TM, FFDRC-TM	265 kW		09/07→			
41.360 FFDK-WW	265 kW		09/03→			
41.360 FFD-TM	265 kW		12/04→			
41.390, 41.400 FFDC, FFDRC, FFDRC/M	287 - 294 kW		12/04→			
41.390, 41.400 FFDK, FFDRC	287 - 294 kW		12/04→			
41.390, 41.400 FFD-TM	287 - 294 kW		12/04→			
41.390 FFDAK	287 kW		12/04→			
41.390 FFDC-TM, FFDRC-TM	287 kW		09/07→			
41.400 FFD	294 kW		12/08→			
41.400 FFDC-TM, FFDRC-TM	294 kW		09/07→			

Manufacturer - Model	Power	Displ.	Year of Constr.	Remark	Part Number	Page
MAN - TGA						04/00→
41.410 FFDK	301 kW		07/06→	Depth [mm]: 180; L 360 mm; Vers. produced by AKG; W 166 mm	8MO 376 765-501 Oil Cooler, retarder	628
41.410 FFDC-WW, FDRC	301 kW		09/03→			
41.410 FFDK-WW	301 kW		09/03→	Depth [mm]: 170; L 350 mm; Vers. produced by AKG; W 175 mm	8MO 376 765-511 Oil Cooler, retarder	628
41.410 FFD-TM	301 kW		12/04→			
41.430, 41.440 FFDC, FFDRC, FFDC/M	316 - 324 kW		12/04→	Depth [mm]: 166; L 360 mm; Vers. produced by AKG; W 180 mm	8MO 376 765-571 Oil Cooler, retarder	628
41.430, 41.440 FFDK, FFDRC	316 - 324 kW		12/04→			
41.430, 41.440 FFD-TM	316 - 324 kW		12/04→			
41.430 FFDK	316 kW		12/04→			
41.430 FFDK	316 kW		07/06→			
41.430 FFDC-TM, FFDRC	316 kW		09/07→			
41.440 FFD/M	324 kW		12/04→			
41.440 FFDK	324 kW		07/06→			
41.440 FFDC, FFDRC	324 kW		12/04→			
41.440 FFDC-TM, FFDRC-TM	324 kW		09/07→			
41.440 FFDK, FFDRC	324 kW		12/04→			
41.460 FFDC-WW, FFDRC	338 kW		09/03→			
41.460 FFDK-WW	338 kW		09/03→			
41.460 FFD-TM	338 kW		12/04→			
41.480 FFD	353 kW		12/08→			
41.480 FFDK	353 kW		07/06→			
41.480 FFDARC	353 kW		07/06→			
41.480 FFDC, FFDRC, FFDC/M	353 kW		02/06→			
41.480 FFDC-TM, FFDRC-TM	353 kW		09/07→			
41.480 FFDC-WW, FFDRC	353 kW		06/05→			
41.480 FFDK, FFDRC	353 kW		02/06→			
41.480 FFDK-WW	353 kW		06/05→			
41.480 FFD-TM	353 kW		12/04→			
41.480 FFD-TM	353 kW		02/06→			
41.480 FVDS, FVDLS	353 kW		07/06→			
41.530 FFDK	353 kW		07/06→			
41.530 FFDK	390 kW		07/06→			
41.530 FFDC	390 kW		12/04→			
41.530 FFDK	390 kW		12/04→			
41.530 FFD-TM	390 kW		12/04→			
41.530 FVDS, FVDLS	390 kW		09/02→			
41.540 FVDS, FVDLS	397 kW		11/06→			
41.660 FVDS, FVDLS	485 kW		09/02→			
MAN - TGS						09/07→
18.320 FAC, FHLC	235 kW		10/07→	Depth [mm]: 180; L 360 mm; Vers. produced by AKG; W 166 mm	8MO 376 765-501 Oil Cooler, retarder	628
18.320 FAK, FAK-L, FALK, FALK-L, FHLK, FHLK/M	235 kW		10/07→			
18.320 FAS, FHLS, FHLS/M	235 kW		10/07→			
18.320 FC, FLC, FLRC, FLLC, FLLRC, FLLW, FLLW/N	235 kW		10/07→			
18.320 FK, FK-L, FLK, FLK/M	235 kW		10/07→			
18.320 FLS, FLS/M, FLS-TS, FLRS, FLRS/M, FLLS, FLLS/N, FLLRS	235 kW		10/07→			
18.360 FAC, FHLC	265 kW		10/07→			
18.360 FAK, FAK-L, FALK, FALK-L, FHLK, FHLK/M	265 kW		10/07→			
18.360 FAS, FALS, FHLS, FHLS/M	265 kW		10/07→			
18.360 FC, FLC, FLRC, FLLC, FLLRC, FLLW, FLLW/N	265 kW		10/07→			
18.360 FK, FK-L, FLK, FLK/M	265 kW		10/07→			
18.360 FLS, FLS/M, FLS-TS, FLRS, FLRS/M, FLLS, FLLS/N, FLLRS	265 kW		10/07→			
18.400 FAC, FHLC	294 kW		10/07→			
18.400 FAK, FAK-L, FALK, FALK-L, FHLK, FHLK/M	294 kW		10/07→			
18.400 FAS, FALS, FHLS, FHLS/M	294 kW		10/07→			
18.400 FC, FLC, FLRC, FLLC, FLLRC, FLLW, FLLW/N	294 kW		10/07→			
18.400 FK, FK-L, FLK, FLK/M	294 kW		10/07→			
18.400 FLS, FLS/M, FLS-TS, FLRS, FLRS/M, FLLS, FLLS/N, FLLRS	294 kW		10/07→			
18.440 FAC, FHLC	324 kW		10/07→			
18.440 FAK, FAK-L, FALK, FALK-L, FHLK, FHLK/M	324 kW		10/07→			
18.440 FAS, FALS, FHLS, FHLS/M	324 kW		10/07→			
18.440 FC, FLC, FLRC, FLLC, FLLRC, FLLW, FLLW/N	324 kW		10/07→			
18.440 FK, FK-L, FLK, FLK/M	324 kW		10/07→			

Manufacturer - Model	Power	Displ.	Year of Constr.	Remark	Part Number	Page
MAN - TGS						09/07→
18.440 FLS, FLS/M, FLS-TS, FLRS, FLRS/M, FLLS, FLLS/N, FLLRS	324 kW		10/07→	Depth [mm]: 180; L 360 mm; Vers. produced by AKG; W 166 mm	8MO 376 765-501 Oil Cooler, retarder	628
18.480 FAC, FHLC	353 kW		10/07→			
18.480 FAK, FAK-L, FALK, FALK-L, FHLK, FHLK/M	353 kW		10/07→			
18.480 FAS, FALS, FHLS	353 kW		10/07→			
18.480 FC, FLC, FLRC, FLLC, FLLRC, FLLW, FLLW/N	353 kW		10/07→			
18.480 FK, FK-L, FLK, FLK/M	353 kW		10/07→			
18.480 FLS, FLS/M, FLS-TS, FLRS, FLRS/M, FLLS, FLLS/N, FLLRS	353 kW		10/07→			
18.540 FAC, FHLC	397 kW		10/07→			
18.540 FAK, FAK-L, FALK, FALK-L, FHLK, FHLK/M	397 kW		10/07→			
18.540 FAS, FALS, FHLS, FHLS/M	397 kW		10/07→			
18.540 FC, FLC, FLRC, FLLC, FLLRC, FLLW, FLLW/N	397 kW		10/07→			
18.540 FK, FK-L, FLK, FLK/M	397 kW		10/07→			
18.540 FLS, FLS/M, FLRS, FLRS/M, FLLS, FLLS/N, FLLRS	397 kW		10/07→			
24.320 FNLLW/N	235 kW		10/07→			
24.360 FNLLW/N	265 kW		10/07→			
24.360 FPLS, FPLRS	265 kW		10/07→			
24.400 FNLLW/N	294 kW		10/07→			
24.400 FPLS, FPLRS	294 kW		10/07→			
24.440 FNLLW/N	324 kW		10/07→			
24.440 FPLS, FPLRS	324 kW		10/07→			
24.480 FPLS, FPLRS	353 kW		10/07→			
24.540 FPLS, FPLRS	397 kW		10/07→			
26.320 FDAC, FDALC, FDHLC, FDHLC/M	235 kW		07/08→			
26.320 FDAK, FDALK, FDHK, FDHLK	235 kW		07/08→			
26.320 FDAS, FDALS, FDHS, FDHLS, FDHLS/M	235 kW		07/08→			
26.320 FDC, FDRC, FDLC, FDLC/M, FDLRC, FDLRC/M, FNHLC	235 kW		07/08→			
26.320 FDK, FDLK	235 kW		07/08→			
26.320 FDS, FDLS, FDLS/M, FDRS, FDLRS, FDLRS/M, FNHLS	235 kW		07/08→			
26.320 FNLC, FNLRC, FNLLC, FNLLRC, FNLLW, FVLC, FVL- KO	235 kW		10/07→			
26.320 FNLS, FNLRS, FNLLS, FPLS, FVLS	235 kW		07/08→			
26.320 FVHLC	235 kW		10/07→			
26.360 FDAC, FDALC, FDHLC, FDHLC/M	265 kW		08/08→			
26.360 FDAK, FDALK, FDHK, FDHLK	265 kW		08/08→			
26.360 FDAS, FDALS, FDHS, FDHLS, FDHLS/M	265 kW		08/08→			
26.360 FDC, FDRC, FDRC/M, FDLC, FDLRC, FNHLC	265 kW		08/08→			
26.360 FDK, FDLK, FDRK	265 kW		08/08→			
26.360 FDS, FDRS, FDRS/M, FDLS, FDLRS, FNHLS	265 kW		08/08→			
26.360 FD-TM	265 kW		07/08→			
26.360 FNLC, FNLRC, FNLLC, FNLLRC, FVLC, FVL-KO	265 kW		10/07→			
26.360 FNLLW	265 kW		04/08→			
26.360 FNLS, FNLLS, FNLRS, FPLS, FPLRS, FVLS	265 kW		08/08→			
26.360 FPHLS	265 kW		05/08→			
26.360 FVHLC	265 kW		10/07→			
26.360 FVHLS	265 kW		05/08→			
26.400 FDAC, FDALC, FDHLC, FDHLC/M	294 kW		02/09→			
26.400 FDAK, FDALK, FDHK, FDHLK	294 kW		11/07→			
26.400 FDAS, FDALS, FDHS, FDHLS, FDHLS/M	294 kW		09/07→			
26.400 FDC, FDRC, FDC/M, FDLC, FDLC/M, FDLRC, FDLRC/M, FNHLC	294 kW		08/08→			
26.400 FDK, FDLK	294 kW		02/09→			

Manufacturer - Model	Power	Displ.	Year of Constr.	Remark	Part Number	Page
MAN - TGS						09/07→
26.400 FDS, FDS/M, FDLS, FDLS/M, FDRS, FDLRS, FNHLS	294 kW		02/09→	Depth [mm]: 180; L 360 mm; Vers. produced by AKG; W 166 mm	8MO 376 765-501 Oil Cooler, retarder	628
26.400 FD-TM	294 kW		07/08→			
26.400 FNLC, FNLRC, FNLLC, FNLLRC, FVLC, FVL-KO, FNLLW	294 kW		10/07→			
26.400 FNLS, FNLRS, FNLLS, FNLLRS, FPLS, FPLRS, FVLS	294 kW		02/09→			
26.400 FPHLS	294 kW		05/08→			
26.400 FVHLC	294 kW		10/07→			
26.400 FVHLS	294 kW		05/08→			
26.440 FDAC, FDALC, FDHLC, FDHLC/M	324 kW		02/09→			
26.440 FDAK, FDALK, FDHK, FDHLK	324 kW		11/07→			
26.440 FDAS, FDALS, FDHLS, FDHLS/M	324 kW		02/09→			
26.440 FDC, FDC/M, FDLC, FDLC/M, FDLRC, FNHLC	324 kW		02/09→			
26.440 FDK, FDLK	324 kW		07/08→			
26.440 FDS, FDRS, FDS/M, FDLRS, FNHLS	324 kW		02/09→			
26.440 FD-TM	324 kW		07/08→			
26.440 FNLC, FNLLC, FNLLW, FNLRC, FNLLRC, FVLC, FVL-KO	324 kW		10/07→			
26.440 FNLS, FNLLS, FNLRS, FPLS, FPLRS, FVLS	324 kW		02/09→			
26.440 FPHLS	324 kW		05/08→			
26.440 FVHLC	324 kW		10/07→			
26.440 FVHLS	324 kW		05/08→			
26.480 FDC, FDC/M, FDLC, FDLC/M, FDRC, FDRC/M, FDLRC, FNLHC	353 kW		02/09→			
26.480 FDK, FDLK	353 kW		07/08→			
26.480 FDS, FDS/M, FDLS, FDLS/M, FDRS, FDLRS, FDRS/M, FNHLS	353 kW		02/09→			
26.480 FNLC, FNLRC, FNLLC, FNLLRC, FNLLW, FVLC, FVL-KO	353 kW		10/07→			
26.480 FNLS, FNLLS, FNLRS, FPLS, FPLRS, FVLS	353 kW		02/09→			
33.360 FDAC, FDALC	265 kW		06/08→			
33.360 FDAK, FDALK, FDHK	265 kW		10/07→			
33.360 FDAS, FDALS, FDHS	265 kW		10/07→			
33.360 FDC, FDLC	265 kW		06/08→			
33.360 FDK, FDLK	265 kW		02/09→			
33.360 FDS, FDLS	265 kW		06/08→			
33.400 FDAC, FDALC	294 kW		07/08→			
33.400 FDAK, FDALK, FDHK	294 kW		07/08→			
33.400 FDAS, FDALS, FDHS	294 kW		07/08→			
33.400 FDC, FDLC	294 kW		06/08→			
33.400 FDK, FDLK	294 kW		07/08→			
33.400 FDS, FDLS	294 kW		07/08→			
33.440 FDAC, FDALC	324 kW		07/08→			
33.440 FDAK, FDALK, FDHK	324 kW		11/07→			
33.440 FDAS, FDALS, FDHS	324 kW		10/07→			
33.440 FDC, FDLC	324 kW		06/08→			
33.440 FDK, FDLK	324 kW		06/08→			
33.440 FDS, FDLS, FDLS/M	324 kW		06/08→			
33.480 FDAC, FDALC	353 kW		08/08→			
33.480 FDAK, FDALK	353 kW		08/08→			
33.480 FDAS, FDALS, FDHS	353 kW		10/07→			
33.480 FDC, FDC/M, FDLC, FDLC/M	353 kW		08/08→			
33.480 FDK, FDLK	353 kW		08/08→			
33.480 FDS, FDLS, FDLS/M	353 kW		08/08→			
33.540 FDAC, FDALC	397 kW		02/09→			
33.540 FDAK, FDALK	397 kW		02/09→			
33.540 FDAS, FDALS	397 kW		02/09→			
33.540 FDC, FDLC, FDLC/M	397 kW		02/09→			
33.540 FDK, FDLK	397 kW		02/09→			
33.540 FDS, FDLS, FDLS/M	397 kW		02/09→			
26.320 FD-TM	235 kW		07/08→	Depth [mm]: 180; L 360 mm; Vers. produced by AKG; W 166 mm	8MO 376 765-501 Oil Cooler, retarder	628
26.480 FDAC, FDALC, FDHLC, FDHLC/M	353 kW		02/09→			
26.480 FDAK, FDALK, FDHK, FDHLK	353 kW		02/09→	Depth [mm]: 166; L 360 mm; Vers. produced by AKG; W 180 mm	8MO 376 765-571 Oil Cooler, retarder	628
26.480 FDAS, FDALS, FDHS, FDHLS	353 kW		02/09→			
26.480 FPHLS	353 kW		05/08→			

Manufacturer - Model	Power	Displ.	Year of Constr.	Remark	Part Number	Page
MAN - TGS						09/07→
26.480 FVHLC	353 kW		10/07→	Depth [mm]: 180; L 360 mm; Vers. produced by AKG; W 166 mm	8MO 376 765-501 Oil Cooler, retarder	628
26.480 FVHLS	353 kW		05/08→			
26.540 FDAC, FDALC, FDHLC, FDHLC/M	397 kW		02/09→	Depth [mm]: 166; L 360 mm; Vers. produced by AKG; W 180 mm	8MO 376 765-571 Oil Cooler, retarder	628
26.540 FDAK, FDALK, FDHLK	397 kW		11/07→			
26.540 FDAS, FDALS, FDHLS	397 kW		02/09→			
26.540 FDC, FDC/M, FDLC, FDLC/M, FDLRC, FDLRC/M, FNHLC	397 kW		02/09→			
26.540 FDK, FDLK	397 kW		02/09→			
26.540 FDS, FDS/M, FDLS, FDRS, FDLRS, FDLS/M, FNHLS	397 kW		02/09→			
26.540 FNLC, FNLRC, FNLLC, FNLLRC, FNLLW, FVLC, FVL-KO	397 kW		10/07→			
26.540 FNLS, FNLLS, FPLS, FPLRS, FVLS	397 kW		02/09→			
28.320 FNHLC	235 kW		07/08→			
28.320 FNLC	235 kW		07/08→			
28.320 FNLS	235 kW		07/08→			
28.360 FANLC, FNHLC	265 kW		08/08→			
28.360 FANLK	265 kW		08/08→			
28.360 FNLC	265 kW		08/08→			
28.360 FNLS	265 kW		08/08→			
28.400 FANLC, FNHLC	294 kW		08/08→			
28.400 FANLK	294 kW		08/08→			
28.400 FNLC	294 kW		08/08→			
28.400 FNLS	294 kW		08/08→			
28.440 FANLC, FNHLC	324 kW		08/08→			
28.440 FANLK	324 kW		08/08→			
28.440 FNLC	324 kW		08/08→			
28.440 FNLS	324 kW		08/08→			
28.480 FANLC, FNHLC	353 kW		08/08→			
28.480 FANLK	353 kW		08/08→			
28.480 FNLC	353 kW		08/08→			
28.480 FNLS	353 kW		08/08→			
28.540 FNHLC	397 kW		06/08→			
28.540 FNLC	397 kW		02/09→			
28.540 FNLS	397 kW		02/09→			
32.320 FFD-TM	235 kW		02/09→	Depth [mm]: 170; L 350 mm; Vers. produced by AKG; W 175 mm	8MO 376 765-511 Oil Cooler, retarder	628
32.360 FFDRC	265 kW		08/08→			
32.360 FFD-TM, FFDR-TM	265 kW		10/07→	Depth [mm]: 166; L 360 mm; Vers. produced by AKG; W 180 mm	8MO 376 765-571 Oil Cooler, retarder	628
32.400 FFDRC	294 kW		08/08→			
32.400 FFD-TM, FFDR-TM	294 kW		10/07→			
32.440 FFDRC	324 kW		08/08→			
32.440 FFD-TM, FFDR-TM	324 kW		10/07→			
32.480 FFD-TM	353 kW		08/08→			
35.320 FFDAK	235 kW		06/08→			
35.320 FFDAK, FFDHLK	235 kW		06/08→			
35.320 FFDC, FFDLC, FDNLC	235 kW		06/08→			
35.320 FFDK, FFDLK	235 kW		08/08→			
35.320 FFD-TM	235 kW		10/07→			
35.320 FFNLC	235 kW		01/09→			
35.360 FFDAK	265 kW		06/08→			
35.360 FFDAK, FFHDLK	265 kW		06/08→			
35.360 FFDC, FFDLC, FDNLC	265 kW		06/08→			
35.360 FFDK, FFDLK, FFDRK	265 kW		08/08→			
35.360 FFD-TM	265 kW		10/07→			
35.360 FFNLC	265 kW		06/08→			
35.400 FFDAK	294 kW		06/08→			
35.400 FFDAK, FFDHLK	294 kW		06/08→			
35.400 FFDC, FFDLC, FDNLC	294 kW		06/08→			
35.400 FFDK, FFDLK, FFDRK	294 kW		08/08→			
35.400 FFD-TM	294 kW		10/07→			
35.400 FFNHLC	294 kW		10/07→			
35.400 FFNLC	294 kW		06/08→			
35.440 FDNLC, FFDC, FFDLC, FFNLC	324 kW		06/08→			
35.440 FFDAK	324 kW		06/08→			
35.440 FFDAK, FFDHLK	324 kW		06/08→			
35.440 FFDK, FFDLK, FFDRK	324 kW		08/08→			
35.440 FFD-TM	324 kW		10/07→			
35.440 FFNHLC	324 kW		10/07→			
35.440 FFNLC	324 kW		06/08→			
35.480 FDNLC, FFDC, FFDLC	353 kW		06/08→			
35.480 FFDAK	353 kW		06/08→			
35.480 FFDAK, FFDHLK	353 kW		06/08→			
35.480 FFDK, FFDLK, FFDRK	353 kW		08/08→			
35.480 FFD-TM	353 kW		10/07→			
35.480 FFNHLC	353 kW		10/07→			
35.480 FFNLC	353 kW		06/08→			

Manufacturer - Model	Power	Displ.	Year of Constr.	Remark	Part Number	Page
MAN - TGS						09/07→
35.540 FDNLC, FFDC, FFDLC	397 kW		06/08→	Depth [mm]: 170; L 350 mm; Vers. produced by AKG; W 175 mm	8MO 376 765-511 Oil Cooler, retarder	628
35.540 FFDK	397 kW		02/09→			
35.540 FFDK, FFDHLK	397 kW		02/09→	Depth [mm]: 166; L 360 mm; Vers. produced by AKG; W 180 mm	8MO 376 765-571 Oil Cooler, retarder	628
35.540 FFDK, FFDLK, FFDRK	397 kW		02/09→			
35.540 FFD-TM	397 kW		10/07→			
35.540 FFNLC	397 kW		02/09→			
41.320 FFDK	235 kW		06/08→			
41.360 FFDK	265 kW		06/08→			
41.360 FFDC	265 kW		07/08→			
41.360 FFDK	265 kW		07/08→			
41.360 FFD-TM	265 kW		10/07→			
41.400 FFDC	294 kW		07/08→			
41.400 FFDK	294 kW		07/08→			
41.400 FFD-TM	294 kW		10/07→			
41.440 FFDK	324 kW		06/08→			
41.440 FFDC	324 kW		07/08→			
41.440 FFDK	324 kW		07/08→			
41.440 FFD-TM	324 kW		10/07→			
41.480 FFDK	353 kW		06/08→			
41.480 FFDARC	353 kW		06/08→			
41.480 FFDC	353 kW		07/08→			
41.480 FFDK	353 kW		07/08→			
41.480 FFD-TM	353 kW		10/07→			
41.540 FFDK	397 kW		02/09→			
41.540 FFDC	397 kW		02/09→			
41.540 FFDK	397 kW		02/09→			
41.540 FFD-TM	397 kW		10/07→			
MAN - TGX						09/07→
18.360 FHLC	265 kW		10/07→	Depth [mm]: 180; L 360 mm; Vers. produced by AKG; W 166 mm	8MO 376 765-501 Oil Cooler, retarder	628
18.360 FHLS, FHLS/M	265 kW		10/07→			
18.360 FLC, FLRC, FLLC, FLLRC, FLLW, FLLW/N	265 kW		10/07→			
18.360 FLS, FLS/M, FLRS, FLRS/N, FLLS, FLLS/N, FLLRS, FLLRS/N	265 kW		10/07→			
18.400 FHLC	294 kW		10/07→			
18.400 FHLS, FHLS/M	294 kW		10/07→			
18.400 FLC, FLRC, FLLC, FLLRC, FLLW, FLLW/N	294 kW		10/07→			
18.400 FLS, FLS/M, FLRS, FLRS/N, FLLS, FLLS/N, FLLRS, FLLRS/N	294 kW		10/07→			
18.440 FHLC	324 kW		10/07→			
18.440 FHLS, FHLS/M	324 kW		10/07→			
18.440 FLC, FLRC, FLLC, FLLRC, FLLW, FLLW/N	324 kW		10/07→			
18.440 FLRC	324 kW		10/07→			
18.440 FLRS	324 kW		10/07→			
18.440 FLS, FLS/M, FLRS, FLRS/M, FLLS, FLLS/N, FLLRS, FLLRS/	324 kW		10/07→			
18.480 FHLC	353 kW		10/07→			
18.480 FHLS, FHLS/M	353 kW		10/07→			
18.480 FLC, FLRC, FLLC, FLLRC, FLLW, FLLW/N	353 kW		10/07→			
18.480 FLS, FLS/M, FLRS, FLRS/N, FLLS, FLLS/N, FLLRS, FLLRS/N	353 kW		10/07→			
18.540 FHLC	397 kW		10/07→			
18.540 FHLS, FHLS/M	397 kW		10/07→			
18.540 FLC, FLRC, FLLC, FLLRC, FLLW, FLLW/N	397 kW		10/07→			
18.540 FLS, FLS/M, FLRS, FLRS/N, FLLS, FLLS/ N, FLLRS, FLLRS/N	397 kW		10/07→			
24.360 FNLLW/N	265 kW		10/07→			
24.360 FPLS, FPLRS	265 kW		10/07→			
24.400 FNLLW/N	294 kW		10/07→			
24.400 FPLS, FPLRS	294 kW		10/07→			
24.440 FNLLW/N	324 kW		10/07→			
24.440 FPLRS	324 kW		10/07→			
24.440 FPLS, FPLRS	324 kW		10/07→			
24.480 FNLLW/N	353 kW		10/07→			
24.480 FPLS, FPLRS	353 kW		10/07→			
24.540 FNLLW/N	397 kW		02/09→			
24.540 FPLS, FPLRS	397 kW		10/07→			
26.320 FNLS, FNLLS	235 kW		10/07→			
26.360 FDC, FDLC, FDRC, FDLRC	265 kW		07/08→			
26.360 FDHLC	265 kW		10/07→			

Manufacturer - Model	Power	Displ.	Year of Constr.	Remark	Part Number	Page
MAN - TGX						09/07→
26.360 FDHLS	265 kW		10/07→	Depth [mm]: 180; L 360 mm; Vers. produced by AKG; W 166 mm	8MO 376 765-501 Oil Cooler, retarder	628
26.360 FDS, FDLS, FDRS, FDLRS	265 kW		07/08→			
26.360 FNHLC	265 kW		10/07→			
26.360 FNHLS	265 kW		12/07→			
26.360 FNLC, FNLRC, FNLLC, FNLLRC, FNLLW	265 kW		10/07→			
26.360 FNLS, FNLLS, FNLRS, FNLLRS, FPLS, FPLRS, FVLS	265 kW		10/07→			
26.360 FVHLS	265 kW		05/08→			
26.400 FDC, FDLC, FDRC, FDLRC	294 kW		07/08→			
26.400 FDHLC	294 kW		10/07→			
26.400 FDHLS	294 kW		10/07→			
26.400 FDS, FDLS, FDRS, FDLRS	294 kW		07/08→			
26.400 FNHLC	294 kW		12/07→			
26.400 FNHLS	294 kW		12/07→			
26.400 FNLC, FNLRC, FNLLC, FNLLRC, FNLLW	294 kW		10/07→			
26.400 FNLS, FNLLS, FNLRS, FNLLRS, FPLS, FPLRS, FVLS	294 kW		10/07→			
26.400 FPHLS	294 kW		05/08→			
26.400 FVHLS	294 kW		05/08→			
26.440 FDC, FDLC, FDRC, FDLRC	324 kW		07/08→			
26.440 FDHLC	324 kW		09/07→			
26.440 FDHLS	324 kW		10/07→			
26.440 FDS, FDLS, FDRS, FDLRS	324 kW		07/08→			
26.440 FNHLC	324 kW		12/07→			
26.440 FNHLS	324 kW		12/07→			
26.440 FNLC, FNLRC, FNLLC, FNLLRC, FNLLW	324 kW		10/07→			
26.440 FNLS, FNLLS, FNLRS, FNLLRS, FPLS, FPLRS, FVLS	324 kW		10/07→			
26.440 FPHLS	324 kW		05/08→			
26.440 FPLRS	324 kW		07/08→			
26.440 FVHLS	324 kW		05/08→			
26.480 FDC, FDLC, FDRC, FDLRC	353 kW		07/08→			
26.480 FDHLC	353 kW		09/07→			
26.480 FDHLS	353 kW		10/07→			
26.480 FDS, FDLS, FDRS, FDLRS	353 kW		07/08→			
26.480 FNHLC	353 kW		12/07→			
26.480 FNHLS	353 kW		12/07→			
26.480 FNLC, FNLRC, FNLLC, FNLLRC, FNLLW	353 kW		10/07→			
26.480 FNLS, FNLLS, FNLRS, FNLLRS, FPLS, FPLRS, FVLS	353 kW		10/07→			
26.480 FPHLS	353 kW		05/08→			
26.480 FVHLS	353 kW		05/08→			
26.540 FDC, FDLC, FDRC, FDLRC	397 kW		02/09→			
26.540 FDS, FDLS, FDRS, FDLRS	397 kW		02/09→			
26.540 FNLC, FNLRC, FNLLC, FNLLRC, FNLLW	397 kW		10/07→			
26.540 FNLS, FNLRS, FNLLS, FPLS, FPLRS, FVLS	397 kW		10/07→			
28.360 FNLC	265 kW		10/07→			
28.360 FNLS	265 kW		10/07→			
28.400 FNLC	294 kW		10/07→			
28.400 FNLS	294 kW		10/07→			
28.440 FNLC	324 kW		10/07→			
28.440 FNLS	324 kW		10/07→			
28.480 FNLC	353 kW		10/07→			
28.480 FNLS	353 kW		10/07→			
28.540 FNLC	397 kW		10/07→			
28.540 FNLS	397 kW		02/09→			
33.680 FDLC	500 kW		10/07→			
33.680 FDLS	500 kW		10/07→			
41.540 FVDS, FVDLS	397 kW		06/08→			



DAF	HELLA
164 3669	8MO 376 765-511
184 0389	8MO 376 765-511
IVECO	HELLA
4253 6683	8MO 376 765-501
4255 5327	8MO 376 765-501
9319 3341	8MO 376 765-501
MAN	HELLA
81.32560.0041	8MO 376 765-501
81.32560.0051	8MO 376 765-501
81.32560.0055	8MO 376 765-501
81.32560.0059	8MO 376 765-511
81.32560.0071	8MO 376 765-501
81.32560.6082	8MO 376 765-571
81.32560.6092	8MO 376 765-501
RENAULT TRUCKS	HELLA
50 01 857 529	8MO 376 765-571
50 01 865 807	8MO 376 765-511

**8MO ...**

8MO 376 765-501	628
8MO 376 765-511	628
8MO 376 765-571	628

HELLA KGaA Hueck & Co.

Rixbecker Straße 75
59552 Lippstadt /Germany
Tel. +49 2941 38-0
Fax +49 2941 38-71 33
info@hella.com
www.hella.com/truck

© HELLA KGaA Hueck & Co., Lippstadt