

CATALOG SISTEME CAROSERII



SC AMARI ROMANIA SRL

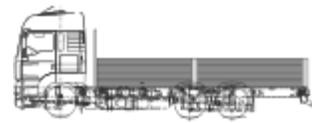
**Piata Ignatie Darabant nr.15 – 410235, ORADEA
jud. Bihor, Romania**

**C.U.I.: RO 15171700, platitor de TVA
Nr. de ord. in registrul comertului : J05/81/2003**

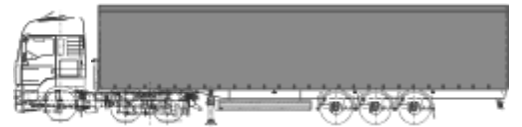
**Cont bancar: RO94 BACX 0000 0003 3005 1310
UNICREDIT TIRIAC BANK**

INDEX

0	PREZENTARE
1	SISTEME PLATFORMA
2	STRUCTURI PRELATA
3	SISTEME PENTRU LEMN
4	SISTEME BASCULANTE
5	STRUCTURI INCHISE
6	RAMPE
7	ACCESORII
8	SISTEM TIMO
9	TABLE STRIATE
10	ANEXA TEHNICA



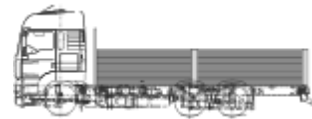
PLATFORME



PRELATE



SISTEME PENTRU LEMN



BASCULANTE



STRUCTURI INCHISE



RAMPE



ACCESORII



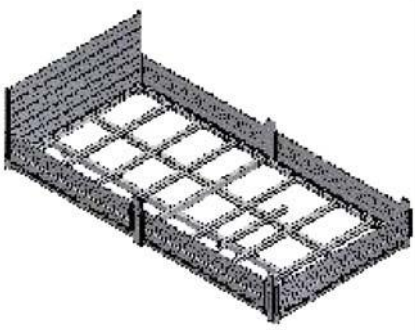
SISTEM TIMO



TABLE STRIATE

COMPONENTE STRUCTURI

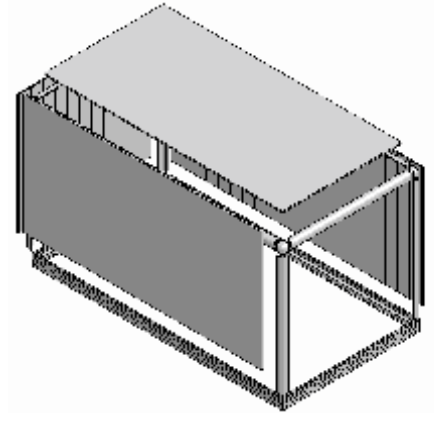
DIMENSIONARE DUPA SOLICITARI



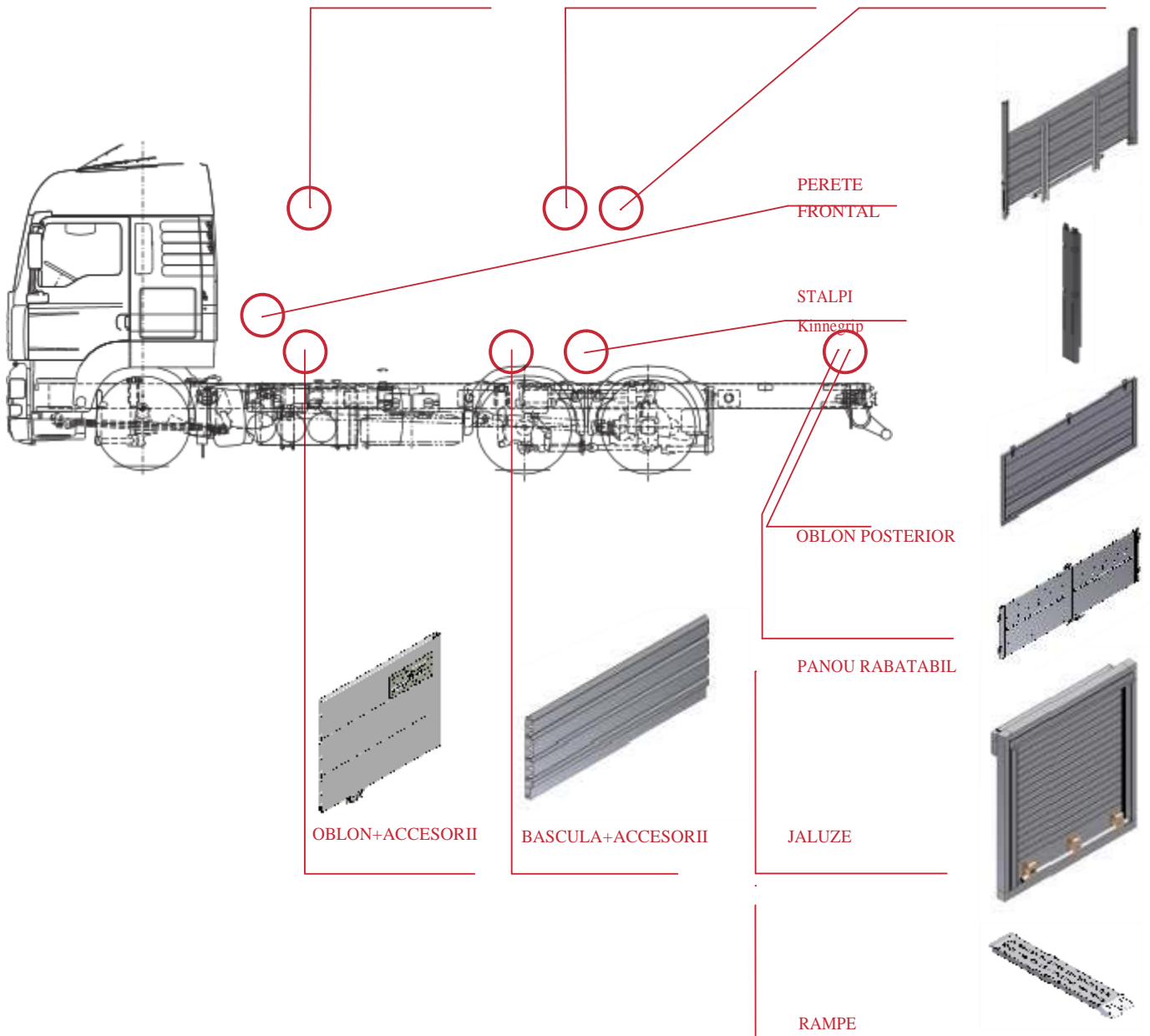
SET COMPLET
PLATFORME / BASCULE



SET COMPLET STRUCTURI
TRANSPORT LEMN

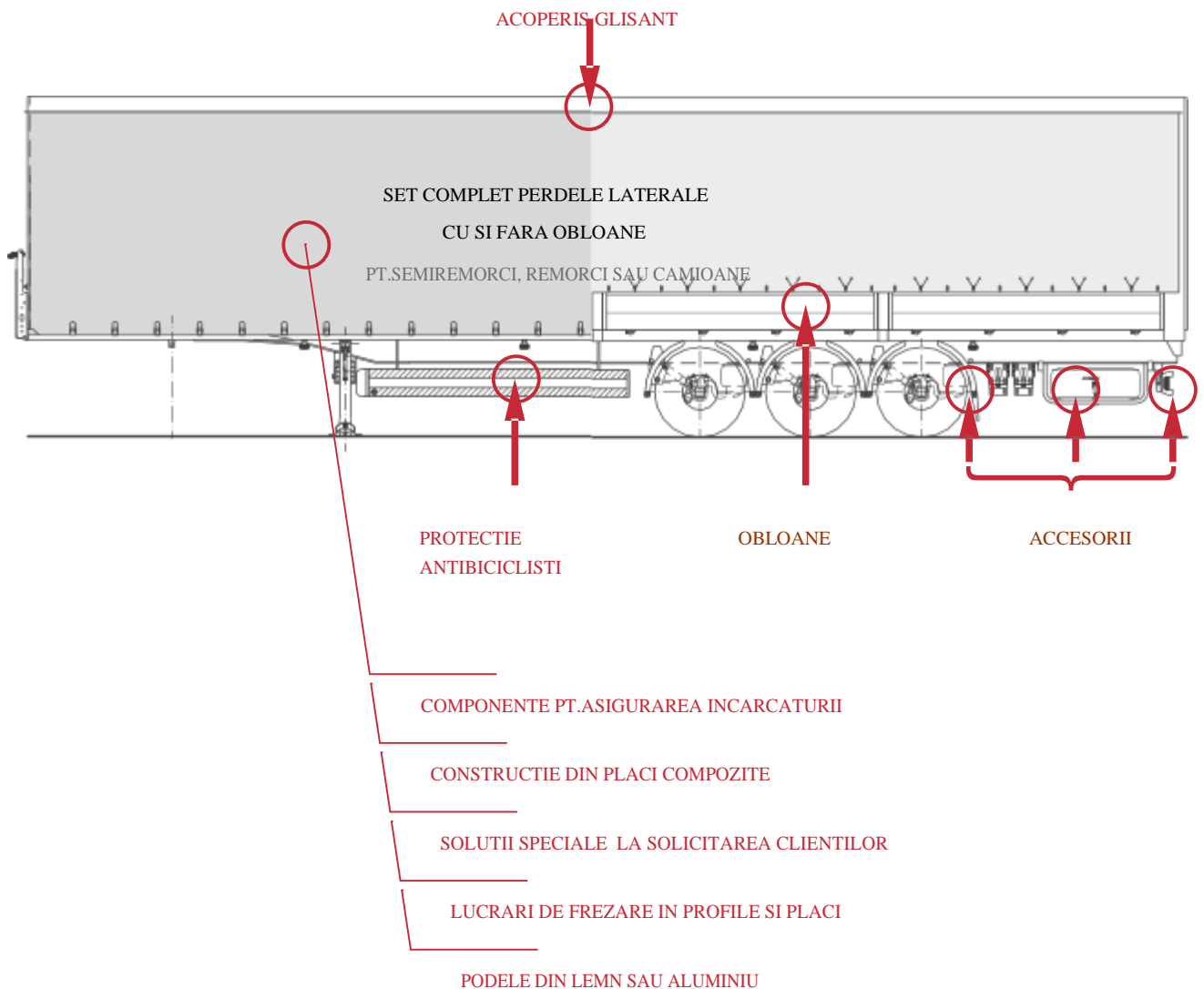
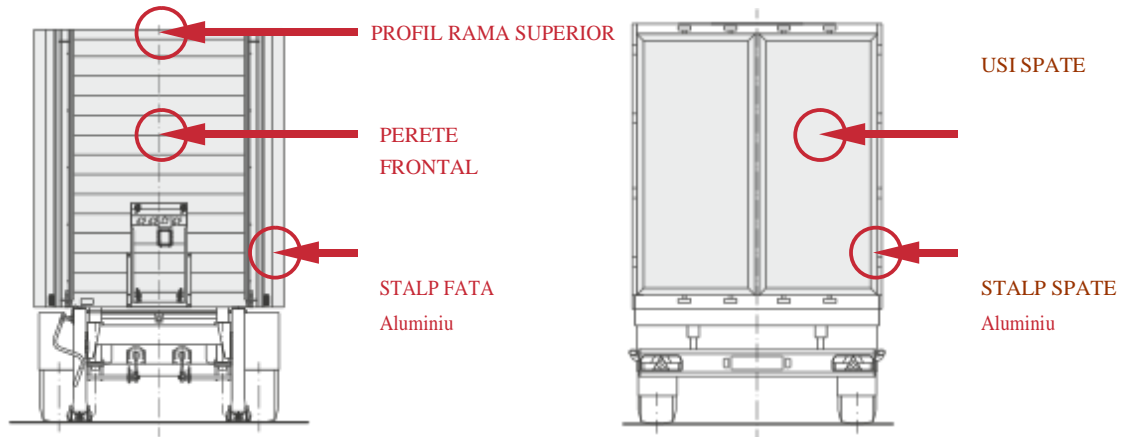


SET COMPLET
STRUCTURI INCHISE



SISTEM PRELATA DECOPERTABILA

DIMENSIONARI DUPA SOLICITARE



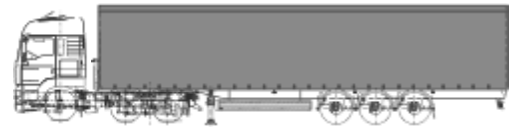
SISTEME PLATFORMA

DIMENSIONARI DUPA SOLICITARE

1.02	OBLON EUROLOCK
1.05	OBLON ZUGANKER
1.06	OBLON ZUGANKER 25 mm
1.07	OBLON MONOBLOC 25 mm
1.08	PROFIL TERMINAL 25 mm
1.10	OBLON ZUGANKER 30 mm
1.12	SISTEME REMORCI
1.13	SISTEME PLATFORME PALCOM/PALFIX
1.18	ACCESORII BALAMA
1.21	ACCESORII INCHIZATOR
1.26	STALPI Kinnegrip



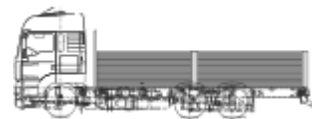
PLATFORME



PRELATE



STRUCTURI PENTRU LEMN



BASCULANTE



STRUCTURI INCHISE



RAMPE



ACCESORII



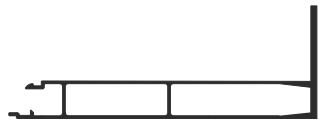







SISTEM TIMO



TABLE
STRIATE














OBLON EUROLOCK

In varianta natur sau eloxat – pe stoc | In varianta vopsit – la cerere

SIMBOL	COD.	DENUMIRE	LUNGINE m
	1008244	PROFIL INFERIOR 200 mm CU PERIMETRU	7,35
	1082441	similar eloxat	7,35
	1007948	PROFIL INFERIOR 100 mm Cu etansare	7,50
	1079483	similar eloxat	7,50
	1541755	Profil inferior 100 mm	7,50
	1007784	Profil inferior 200 mm Cu etansare	7,50 6,50
	1077843	similar eloxat	7,50 6,50
	1007783	Profil inferior 200mm	7,50 6,50
	1077833	Similar eloxat	7,50 6,50
	1007785	Profil intermediar 100 mm	7,50 6,50
	1077853	similar eloxat	7,50 6,50
	1541497	Profil intermediar 150 mm	7,50
	1541493	similar eloxat	7,50
	1007046	Profil intermediar 200 mm	7,50 6,50
	1070463	similar eloxat	7,50 6,50
	1007786	Profil cu prindere directa 120 mm	7,50





OBLON EUROLOCK

In varianta natur sau eloxat – pe stoc | In varianta vopsit – la cerere

SIMBOL	COD	DENUMIRE	LUNGIME ca. m
	1077861	Profil cu prindere directa 120 mm eloxat	7,50
	1541503	Profil pt.prelata 150 mm	La cerere
	1017569	Profil ghidaj rabatabil 200 mm	7,50
	1017570	Profil rabatabil 135 mm	7,40
	1023439	Profil prelata 50 mm	6,50
	1018233	Profil prelata 150 mm	6,00
	1007045	profil intermediar pentru prelată 200 mm	7,50 6,50
	1070453	similar eloxat	7,50 6,50
	1025258	Profil terminal superior 8 mm	la cerere
	1012934	Profil terminal superior 50 mm	la cerere
	1007048	Profil superior 100 mm	7,50
	1070483	similar eloxat	7,50
	1018450	Profil superior 150 mm	la cerere
	1007047	Profil superior 200 mm	7,50 6,50
	1070473	similar eloxat	7,50 6,50
	1541753	Profil superior prelata 200 mm	la cerere









OBLON EUROLOCK

In varianta natur sau eloxat – pe stoc | In varianta vopsit – la cerere

SIMBOL	COD	DENUMIRE	LUNG. ca. m
	1012894	Profil superior 200 mm cu ancorare	la cerere
	1541593	Profil superior 400 mm Garnitura 1063563	7,50 6,50
	1541591	similar eloxat	7,50 6,50
	1701452	Profil superior 400 mm	7,50 6,50
	1701451	similar eloxat	7,50 6,50
	1063563	Etansare la Profil 1007948,1007784,1541593	






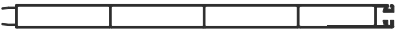


OBLON ZUGANKER

In varianta natur sau eloxat – pe stoc | In varianta vopsit – la cerere

Simbol	cod	denumire	Lung. ca. m
	1044730	profil superior 100 mm	7,50
	1447301	similar eloxat	7,50
	1070191	profil inferior 200 mm etansare 1001220 (vezi pag.1.06)	7,50 6,50
	1701911	similar eloxat	7,50 6,50
	1049063	profil inferior 200 mm	7,50 6,50
	1490631	similar eloxat	7,50 6,50
	1035914	profil intermediar 50 mm	la cerere
	1359141	similar eloxat	la cerere
	1042794	profil intermediar 100 mm	7,50
	1427941	similar eloxat	7,50
	1042795	profil intermediar 200 mm	7,50 6,50
	1427951	similar eloxat	7,50 6,50
	1719092	profil prelata 150 mm	7,20
	1719093	similar eloxat	7,20
	1719074	profil de imbinare 140 x 25 mm	la cerere





000BLON ZUGANKER 25

In varianta natur sau eloxat – pe stoc | In varianta vopsit – la cerere

Simbol	COD.	DENUMIRE	LUNG ca. m
	1042798	profil prelata 200 mm	7,50 6,50
	1427981	eloxat	7,50 6,50
	1042796	profil superior 200 mm	7,50 6,50
	1427961	eloxat	7,50 6,50
	1028140	profil superior 100 mm	la cerere
	1281401	eloxat	la cerere
	1029126	profil superior 50 mm	7,50
	1291261	eloxat	7,50
	1058693	Profil acoperire pt.ancorare	6,00
	1586931	eloxat	6,00
	1701140	profil inferior 400 mm etansare 1001220	7,50 6,50
	7011401	eloxat	7,50 6,50
	1701138	profil superior 400 mm	7,50 6,50
	7011381	eloxat	7,50 6,50
	1001220	etansare Profil 1070191, 1701140	






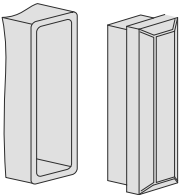



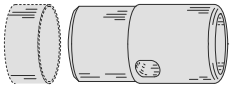
OBLON MONOBLOC 25mm

In varianta natur sau eloxat – pe stoc | In varianta vopsit – la cerere








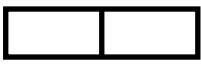
SIMBOL	COD.	Denumire	Lung. ca. m
	5418431	Profil monobloc 400 mm pt.prelata; eloxat cod 5418432	7,50 6,50 4,50
	1033761	Profil 400mm cu etansare eloxat	7,50
	1033651	Profil monobloc 400 mm cu aripa eloxat	7,50
	1256651	Profil monobloc 300 mm pt.prelata	5,35

PROFIL SUSTINERE PRELATA 25
















In varianta natur sau eloxat – pe stoc | In varianta vopsit – la cerere

Simbol	COD.	DENUMIRE	Lung. ca. m
	1007336	profil oblon 150 mm cu imbinare in V	6,60 7,20
	1004766	profil oblon 100 mm cu imbinare in V	6,60 7,20
	1032225	profil prelata 100 x 25 mm	7,50 6,60 4,50
	1322251	profil prelata 100 x 25 mm eloxat	7,50
	1041088	profil prelata 100 x 30 mm	7,50
	1032871	profil profil separator marfa 122x30	7,50
	1000047	dop pt. 1032225	
	1045150	suport otel pt.profil 25 mm	
	1000641	Suport otel stg. spate pt. nituri 26 mm	
	1000642	Suport otel dr. spate pt. nituri 26 mm	
	100237	teava suport prelata 60 x 1,5 mm	4,50 7,50
	1004285	dop plastic suport prelata L = 70 mm pt.100237	0,12 kg/buc.
	1155100	suport pt. teavă D 35 mm cu pat cauciuc	
	1451551	suport pt. teavă D 50 mm cu pat cauciuc	0,50
	1400065	suport pt. profil 25 mm cu ancorare zincat	







PROFILE TERMINALE PT.OBLON 25

Simbol	cod.	Denumire	Lung. ca. m
	1007212	profil terminal	6,50
	1072121	eloxat	6,50
	1027563	profil terminal cu margine 20 mm	6,50
	1275631	eloxat margine: 20 mm	6,50
	1007214	profil terminal cu perimetru: 20 mm	6,50
	1072141	eloxat perimetru 20 mm	6,50
	1017572	profil terminal cu perimetru: 50 mm	7,50
	1175721	eloxat perimetru 50 mm	7,50
	1008830	profil terminal cu inchidere 681S	6,00
	1088301	eloxat	6,00
	1025259	profil terminal cu camera si inchidere 681S + garnitura 1030590 (vezi 1.11)	
			
	1610004	profil terminal pt.stalpi	
			
	1032226	profil suport prelată de 120x25 mm	
			










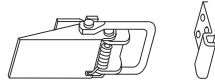
OBLON ZUGANKER 30mm / ZUGANKER 30mm intarit

Simbol	cod.	denumire	Lung. ca. m
	1032949	profil inferior 100 mm	7,40
	1022713	profil inferior cu margine 40 mm 100 mm	6,00
	1000121	profil inferior 200 mm; gros.30mm	7,50
	1050476	profil inferior 200 mm cu etansare	4,40 7,15
	1007667	profil intermediar 50 mm	la cerere
	1005728	profil intermediar 100 mm	4,40 7,40
	1037374	profil intermediar 200 mm; gros.30	4,40 7,15
	1046021	profil intermediar prelata 200 mm; gros.30mm	
	1037373	profil superior 200 mm; gros.30mm	7,50
	1373732	profil superior intarit 200 mm	4,40 7,15
	1026371	profil inferior intarit 88 mm	7,40
	1037377	profil inferior intarit, 88 mm	7,50
	1037376	profil intermediar intarit, 100 mm	7,50
	1037375	profil superior intarit, 112 mm	7,50
	1026646	profil inferior intarit 30/60, 112 mm	5,00 7,40







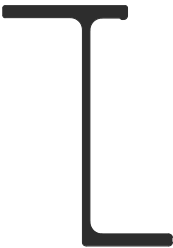

PROFIL TERMINAL ZUGANKER 30mm

Simbol	cod	denumire	Lung ca. m
	1040696	profil terminal pt.profile de 30mm cu pereti subtiri	6,50
	1024907	profil terminal cu margine 20 mm	la cerere
	1032410	profil terminal	6,50
	100059	platbanda 60 x 20 mm	6,50
	100026	platbanda 30 x 10 mm	6,50
	1151408	etanșare pentru profil inferior nr. 1050476	

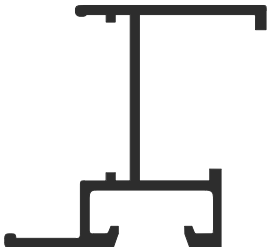
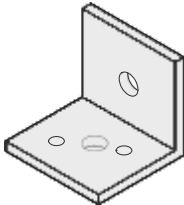
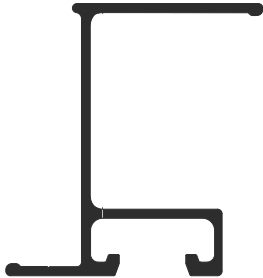
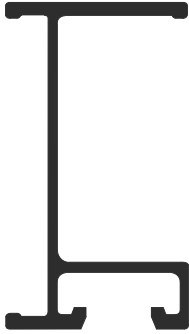
SISTEME PENTRU REMORCI

Simbol	cod.	denumire	greutate kg / buc	Lung. ca. m
	1007870	profil colt		6,60
	1078701	profil colt eloxat		6,60
	1014206	profil terminal remorci		6,00
	1142061	profil terminal eloxat		6,00
	1027563	profil terminal cu margine 20 mm		6,50
	1275631	profil terminal cu margine 20 mm eloxat		6,50
	1044580	profil acoperitor		6,80
	1445801	eloxat		6,80
	100246	suport acoperis FR 30 / 30 / 2		6,50
	100248	suport acoperis FR 35 / 35 / 2		6,50
	1000011	etansare cauciuc pt.profil Nr. 1044580		
	1064230	acoperire colt pt. Profil Nr. 1044580		
	1000030	dop pt. Profil 1007870 1014206		
	1004543	inchizator simplu zincat		
	1010352	inchizator tip broasca zincat		



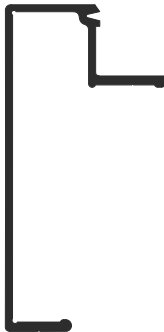

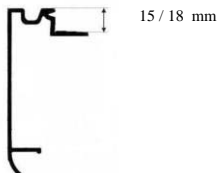
SISTEME PLATFORMA PALCOM / PALFIX

Simbol	cod.	denumire	Lung ca. m
	1006409	lonjeron 80 mm	6,50
	1007316	lonjeron 90 mm	7,50 4,50
	1073161	lonjeron 90 mm eloxat	7,50 4,50
	1007317	lonjeron 108 mm	7,50 4,50 4,90
	1073171	lonjeron 108 mm eloxat	7,50
	1080370	lonjeron 130 mm	7,50
	1052362	lonjeron 160 mm	la cerere
	1031491	lonjeron 200 mm	la cerere

SISTEME PLATFORMA PALCOM / PALFIX

Simbol	cod.	denumire	Lung. ca. m
	1024548	traverse 80 mm	6,60
	1011033	element fixare colt L = 54 mm	
	1007324	traverse 90 mm	6,60 7,50
	1073241	traverse 90 mm eloxate	la cerere
	1007315	traverse 108 mm	6,60 7,50
	1073151	traverse eloxate 108 mm	la cerere
	1007319	traverse 90 mm	6,60 7,50






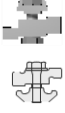
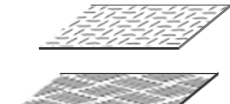
SISTEME PLATFORMA PALCOM / PALFIX

Simbol	cod.	denumire	Lung ca. m
	1007323	profil cadru podea 18 - 21 mm 90 mm intarit	7,50 6,60
	1073231	eloxat	
	1007321	profil cadru podea 18 - 21 mm 108 mm intarit	7,50 6,60
	1073211	eloxat	
	1007326	profil cadru podea 27 - 30 mm 108 mm intarit	7,50
	1073261	eloxat	
	1041440	profil cadru podea 40 - 43 mm 108 mm intarit	7,50
	1414401	eloxat	la crerere
	1007545	profil cadru podea 30 mm	7,50
	1075451	eloxat	
	1054477	cadru podea 21 - 40 mm B = 100 mm	7,50
	1016661	profil cadru de 90 mm pt. podea de 15 mm, anodizat	
	1013971	profil cadru de 90 mm pt. podea 18 mm, anodizat	7,50

SISTEME PLATFORMA PALCOM / PALFIX

Simbol	Cod	Denumire	Greutate
	1538460	element fixare colt din Al, gaurit 100 / 100 / 8	2,20
	153846301	coltar otel universal zincat dreapta	3,60
	153846303	coltar otel universal zincat stanga	3,60
	153846101	coltar otel fata zincat, dreapta pt. profil 1021138	3,60
	153846103	coltar otel fata zincat, stanga pt.profil 1021138	3,60
	100804501	coltar otel spate zincat, dreapta pt.profil Al sau stalp K20	3,60
	100804503	coltar otel spate zincat, stanga pt.profil Al sau stalp K20	3,60
	1642691	set asamblare cu placuta din OL zincata	0,15
	1534900	set asamblare lonjeron, traversă, cadru	0,14
	1534994	piulita set asamblare	0,05
	1534991	placuta set asamblare	0,05

SISTEME PLATFORMA PALCOM / PALFIX


Simbol	Cod	Denumire	Greutate kg / buc.	Lung ca. m
	1007542	Profil podea 21 mm striat B=213 mm		7,50
	1007543	Profil podea 30 mm striat B=200 mm		7,50
	1041095	Profil pentru rampa 30mm		7,50
	1041960	Profil podea 30 mm neted B=200 mm		7,50
	1027485 1041055	Profil podea B = 300 mm striat 30mm Profil podea B = 300mm striat 40mm		7,50
	1007256 1534900	set asamblare profil podea set asamblare lonjeron, l traversa, cadru		
	1158 160	Tabla striata – aluminiu 2.7/3.2 x 2480 x 8000 Tabla striata – aluminiu 8/9.5 x 1250 x 2500		

PODELE ANTIDERAPANTE

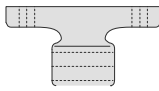

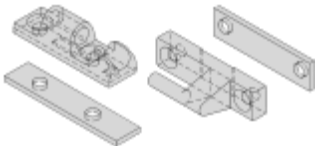
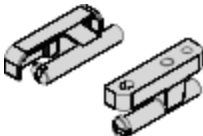


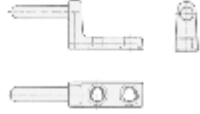
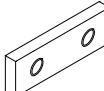


5081183	Mowipan 4 x 2500 x 1250 mm	8.50 kg/mp
5080018	Mowipan 9 x 3000 x 1500 mm	27.54 kg/mp
5081184	Mowipan 9 x 2500 x 1250 mm	19.13 kg/mp
5080016	Mowipan 9 x 2500 x 1500 mm	22.95 kg/mp
5080021	Mowipan 12 x 3000 x 1500 mm	36.72 kg/mp
5080032	Mowipan 12 x 2500 x 1250 mm	25.50 kg/mp
5080020	Mowipan 12 x 2500 x 1500 mm	30.60 kg/mp
5080027	Mowipan 12 x 4200 x 2200 mm	75.40 kg/mp
5080008	Mowipan 15 x 2200 x 1250 mm	28.05 kg/mp
5080033	Mowipan 15 x 2500 x 1250 mm	31.88 kg/mp
5080022	Mowipan 15 x 2500 x 1500 mm	38.25 kg/mp
5080053	Mowipan 18 x 2200 x 1500 mm	40.32 kg/mp
5080034	Mowipan 18 x 2500 x 1250 mm	38.25 kg/mp
5080023	Mowipan 18 x 2500 x 1500 mm	45.90 kg/mp
5081187	Mowipan 21 x 2500 x 1250 mm	44.63 kg/mp
5080024	Mowipan 21 x 2500 x 1500 mm	53.55 kg/mp
5080036	Mowipan 24 x 2500 x 1250 mm	51.00 kg/mp
5081188	Mowipan 27 x 2500 x 1250 mm	57.38 kg/mp
5080011	Mowipan 27 x 2500 x 1500 mm	68.85 kg/mp
5080012	Mowipan 30 x 2500 x 1250 mm	63.75 kg/mp
5081103	Mowipan 30 x 2500 x 1500 mm	75.00 kg/mp
5080132	Mowipan 12 x 2500 x 1250 mm, netratată	26.10 kg/mp
5080031	Mowipan 15 x 2500 x 1250 mm, netratată	32.50 kg/mp
5081105	șurub 6,3 x 70 mm	0.00
5081003	șurub 6,3 x 60 mm	0.00














ACCESORII BALAMALE

Simbol	Cod	Denumire	Greutate kg / buc.
	1511200	placa filetata Al pt. art. Nr. 1006552, 1065523 75 mm dist. Intre gauri	0,07
	1006542	contraplaça pentru balama 1006552	0,13
	1065422	placa filetata pt. art.. 1065522 75 mm dist. Intre gauri	0,13
	1065423	placa filetata 5 gauri	0,20
	1065523	Balama mama zincat	0,25
	1065524	Balama mama cromata	0,25
	1065522	Balama mama zincata Cu gauri filetate M12	0,25
	1065525	Balama mama cromat cu gauri filetate M12	0,25
	1065611	Balama mama zincata cu gauri infundate H=70 mm	0,51
	1016550	Bolt balama sudat stanga, neprelucrat	0,15
	1016551	Bolt balama sudat dreapta, neprelucrat	0,15



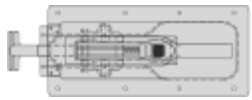


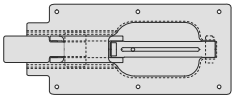
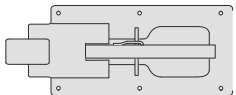
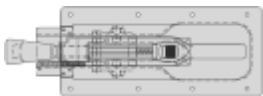
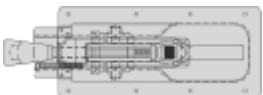

ACCESORII BALAMA

Simbol	COD	DENUMIRE	Greutate kg / buc.
	1065521	Corp balama zincat pt. profil ZUGANKER 25 / 30	0,36
	1006550	cep sudabil pentru balama nr. 1006552	0,20
	1015279	Set balama Tir mic, zincata pentru obloane	0,70
	1152792	Set balama Tir mic, galvanizat complet	0,70
	1008051	Set balama Tir mare, zincat pentru obloane	1,20
	1080512	Set balama Tir mare, galvanizat complet	1,20
	1080511	Set balama TIR mare, zincat complet cu gauri pt. profil ZUGANKER si suruburi	1,20
	1006541	Balama partea tata, zincat insurubabil fara contraplaca	
	1065411	Balama partea tata, zincat insurubabil fara contraplaca cu gauri filetate M12	
	1065412	Balama partea mama, zincat insurubabil fara contraplaca	
	1152609	Lagar balama	
	1152501	Bolt balama	
	1193208	contraplaca dist.intre gauri 50 mm	


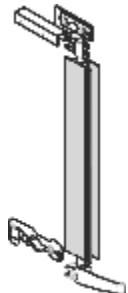
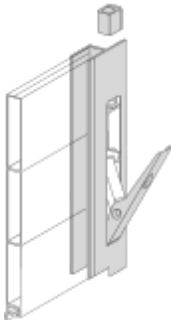
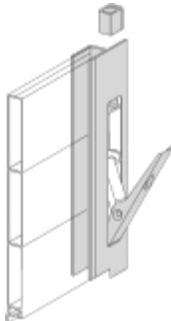
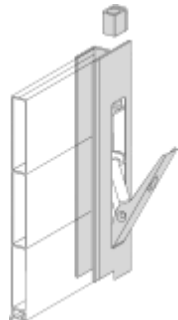
Accesorii BALAMALE / INCHIZATOARE

Simbol	cod.	denumire	Greutate kg / buc.
	1004150	Tija M12 x 415	0,50
	1005150	Tija M12 x 515	0,50
	1006150	Tija M12 x 615	0,55
	1007150	Tija M12 x 715	0,60
	1008150	Tija M12 x 815	0,65
	1009150	Tija M12 x 915	0,70
	1001015	Tija M12 x 1015	0,75
	1006533	Piulita infundata M12 zincat	0,05
	1000123	Tija filetata M 12 zincata L = 3000 mm	
	1008300	Surub M8 x 30 zincat	
	1000825	Surub M8 x 25 zincat	
	1010352	Închizator broasca zincat	0,34
	1020128	Incuietor zincat	0,15



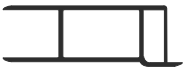
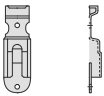
Accesorii INCHIZATOARE

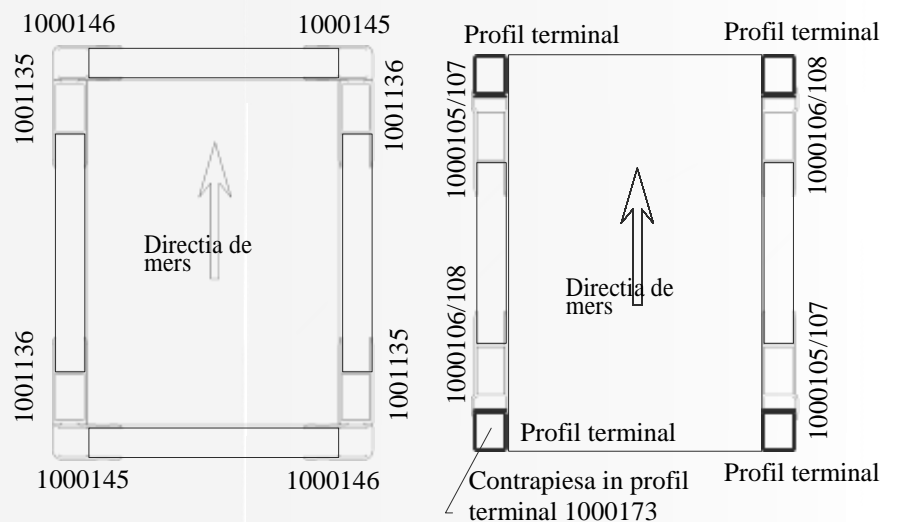
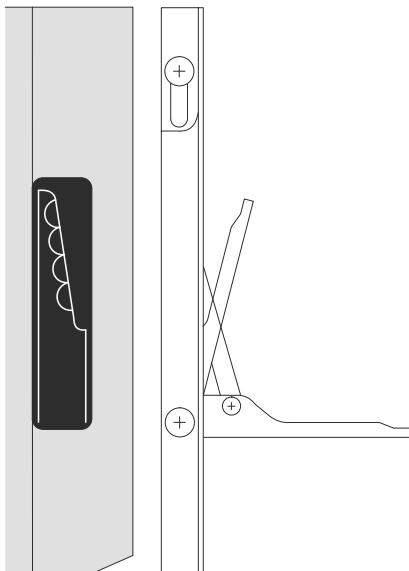
Simbol	Cod.	Denumire	Greutate kg / buc.
	1000686	Inchizator cu limba reglabila tip T-zincat	1,15
	1006863	Contrapiesa	0,20
	1068101	Inchizator cu limba reglabila tip T-zincat cu siguranta	1,57
	1068173	Contrapiesa pt. 1068101	0,21
	1681712	Contrapiesa zincata insurubabila pt. 1068101	0,21
	1000685	Inchizator cu limba incastrat	1,70
	1000682	Inchizator cu limba incastrat	1,50
	1006812	Inchizator incastrat zincat cu bolt 681N cu blocare	1,62
	1000681	Inchizator incastrat zincat cu bolt 681N	1,62
	1006811	Contrapiesa pt. 1000681	0,20

Accesorii INCHIZATOR

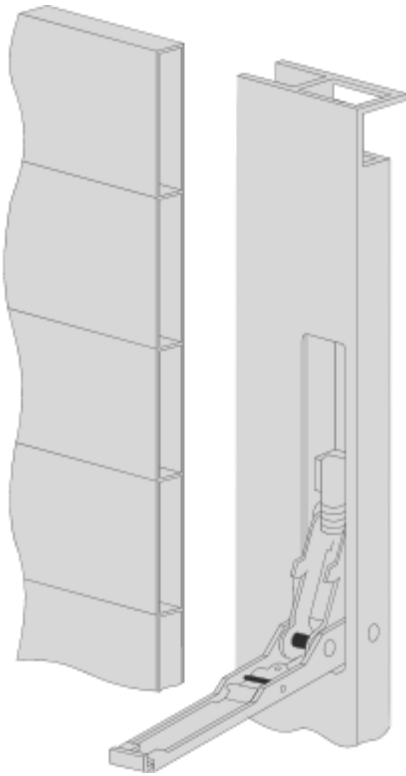

Simbol	Cod	Denumire	Greutate kg / buc
	1219056	Balama cu aripa posteroara aluminiu eloxat la cerere L = 600	2,00
	1219057	Balama cu aripa posteroara aluminiu eloxat la cerere L = 700	2,10
	1219058	Balama cu aripa posteroara aluminiu Eloxat la cerere L = 800	2,30
	2297016	Inchizator pt.usi pliante Aluminiu eloxat la cerere incl. contrapiese fata + spate L = 600	6,15
	2297017	Inchizator pt.usi pliante Aluminiu eloxat la cerere incl. contrapiese fata + spate L = 700	6,30
	2297018	Inchizator pt.usi pliante Aluminiu eloxat la cerere incl. contrapiese fata + pate L = 800	6,50
	1034204	Închizător pentru oblon de 400 mm tip Z cu perimetru stanga + dreapta	1,10
	1034205	Similar, fara perimetru stanga + dreapta	1,10
	1034208	Inchizator pt.oblon 600 mm tip Z stanga + dreapta	1,30
	1034209	Similar, cu perimetru stanga + dreapta	1,35
	1034206	Inchizator pt.oblon de 500mm Tip Z, stanga +dreapta	
	1034207	Inchizator pt.oblon de 800 mm Tip Z, stanga +dreapta	

Accesorii INCHIZATOR

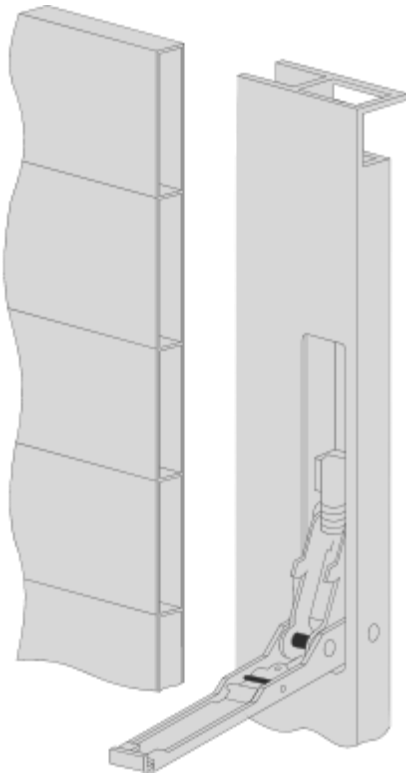

Simbol	Cod	Denumire	Greutate kg / buc.
	1001135	inchizator pt. oblon 400mm stanga spate	0,86
	1001136	similar dreapta	0,86
	1000145	contrapiesa in profil terminal pentru inchizator nr. 1001136	0,52
	1000146	similar pt. inchizator 1001135	0,52
	1000105	Inchizator de 25 mm pentru oblon de 400 mm stanga, eloxat	0,90
	1000107	similar pentru oblon de 600 mm	
	1000106	Inchizator de 25 mm pentru oblon de 400 mm dreapta, eloxat	0,90
	1000108	similar pentru oblon de 600 mm	
	1000173	contrapiesă zincată față pentru închizător nr. 1000105 și nr. 1000106	0,06



Accesorii INCHIZATOR exterior neted, lucios - in profil terminal

Simbol	Cod	Denumire	Greutate kg / buc.	Inaltime ca. mm
	1000714	Inchizator stanga	1,35	400
	1007141	Inchizator dreapta	1,35	400
	1000716	Inchizator stanga	1,70	600
	1007161	Inchizator dreapta	1,70	600
	1000718	Inchizator stanga	2,00	800
	1007181	Inchizator dreapta	2,00	800
	1000715	Inchizator stanga in 2 puncte	3,60	1000
	1007151	Inchizator dreapta in 2 puncte	3,60	1000
	1071020	Contrapiesa stanga sudabila	0,13	
	1171020	Contrapiesa dreapta sudabila	0,13	

Accesorii INCHIZATOR exterior neted, eloxat – in profil terminal

Simbol	Cod	Denumire	Greutate kg / buc.	Inaltime mm
	1071411	Inchizator stanga	1,35	400
	1714111	Inchizator dreapta	1,35	400
	1071611	Inchizator stanga	1,70	600
	1716111	Inchizator dreapta	1,70	600
	1071811	Inchizator stanga	2,00	800
	1718111	Inchizator dreapta	2,00	800
	1007115	Inchizator stanga in 2 puncte	3,60	1000
1071151	Inchizator dreapta in 2 puncte	3,60	1000	
	1071020	Contrapiesa stanga sudabila	0,13	
	1171020	Contrapiesa dreapta sudabila	0,13	

Stalpii au fost dimensionati tinand cont de cele mai ridicate cerinte din transporturile de marfa, de siguranta si protectia muncii..

S-a urmarit reducerea greutatii, ridicarea sarcinii admisibile si o manevrabilitate cat mai buna.

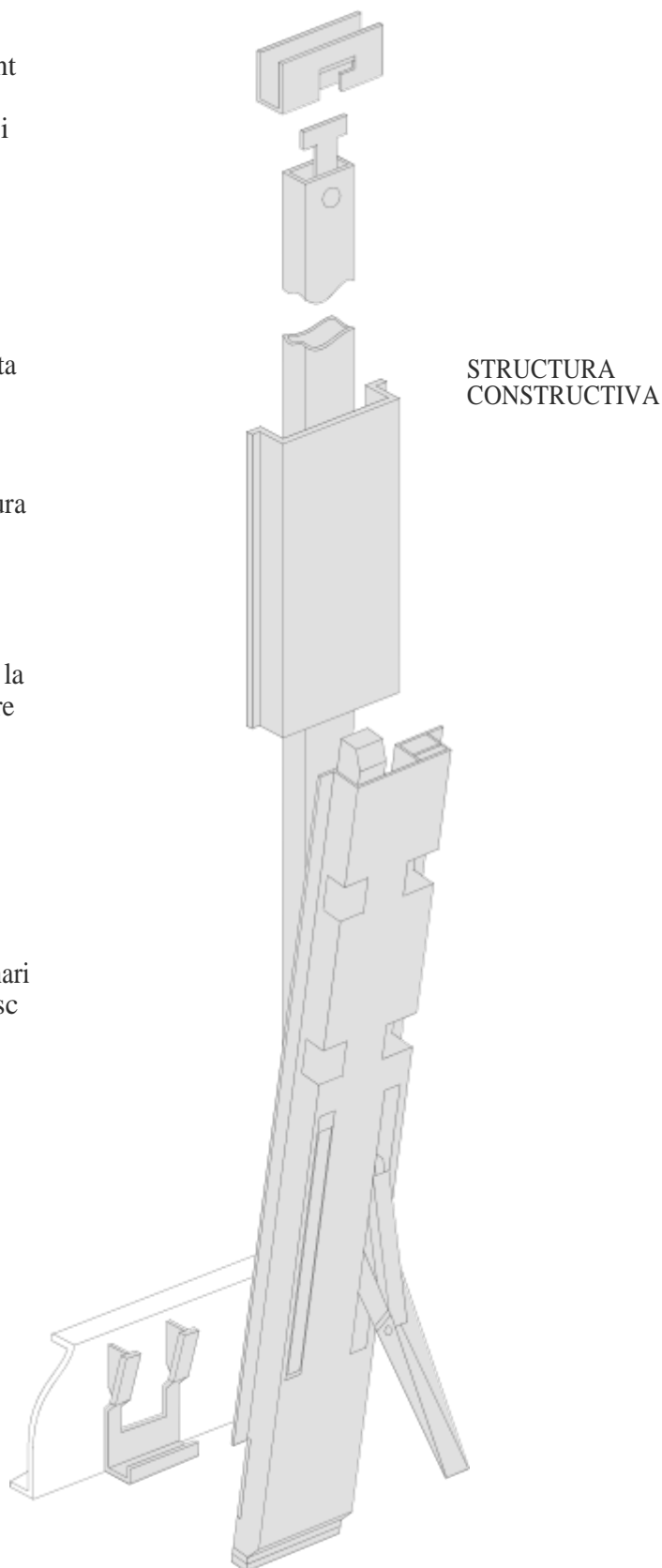
Prin utilizarea unor materiale de calitate superioara s-a obtinut o rezistenta ridicata bazata pe dimensiunea corespunzatoare.

Din experienta se cunoaste ca in structura intervin vibratii care solicita suportul .




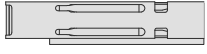







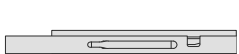
Pentru a inlatura aceste influente, structura peretelui posterior trebuie construita in asa fel incat sa fie reduse la minim balansul si miscarile laterale care se transmit in suport.

S-a demonstrat ca incarcarea statica pe structura este redusa atunci cand obloanele si stalpii nu sunt asigurati cu lanturi.

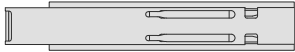
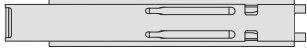
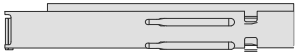
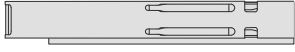







Pentru a avea garantia unei bune functionari a stalpilor K20, aceste conditii trebuiesc indeplinite.















Stalpi Kinnegrip - Tip K20, Otel, 500 + 600 mm

Simbol	Cod	Denumire	Inalt. mm	Greutate kg / buc
	1205201	Stalp intermediar	500	8,70
	1205231	Stalp intermediar cu inalfator	500	8,90
	1205901	Stalp stanga spate	500	8,70
	1205001	Stalp dreapta spate	500	8,70
	1205301	Stalp stanga fata	500	2,80
	1205401	Stalp dreapta fata	500	2,80
	1206201	Stalp intermediar	600	9,60
	1206231	Stalp intermediar cu inalfator	600	9,80
	1206901	Stalp stanga spate	600	9,60
	1206001	Stalp dreapta spate	600	9,60
	1206301	Stalp stanga fata	600	3,10
	1206401	Stalp dreapta fata	600	3,10


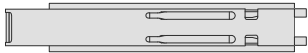
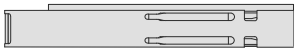


Stalpi KINNEGRIP - Tip K20, oțel, 800 + 1000 mm

Simbol	Cod.	Denumire	Inaltime .mm	Greutate kg / Buc.
	1208241	Stalp intermediar Suport la cerere	800	11,70
	1208251	Stalp intermediar cu inaltator Suport la cerere	800	12,10
	1208941	Stalp stanga spate Suport la cerere	800	11,70
	1208041	Stalp dreapta spate Suport la cerere	800	11,70
	1208341	Stalp stanga fata Suport la cerere	800	4,10
	1208441	Stalp dreapta fata Suport la cerere	800	4,10
	1210201	Stalp intermediar	1000	13,80
	1210231	Stalp intermediar cu inaltator	1000	14,20
	1210901	Stalp stanga spate	1000	13,70
	1210001	Stalp dreapta spate	1000	13,70
	1210301	Stalp stanga fata	1000	4,90
	1210401	Stalp dreapta fata	1000	4,90






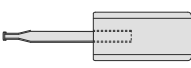
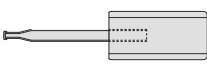
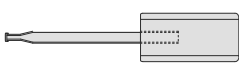
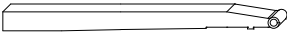
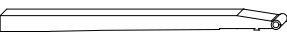
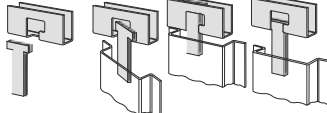
Stalp Kinnegrip - Tip K20, Aluminiu, 500 + 600 mm

Simbol	Cod	Denumire	Inaltim e mm	Greutate kg / buc.
	1205202	Stalp intermediar	500	5,00
	1205232	Stalp intermediar cu inaltator	500	5,10
	1205902	Stalp stanga spate	500	4,90
	1205002	Stalp dreapta spate	500	4,90
	1205302	Stalp stanga fata	500	2,50
	1205402	Stalp dreapta fata	500	2,50
	1206202	Stalp intermediar	600	5,30
	1206232	Stalp intermediar cu inaltator	600	5,40
	1206902	Stalp stanga spate	600	5,20
	1206002	Stalp dreapta spate	600	5,20
	1206302	Stalp stanga fata	600	3,00
	1206402	Stalp dreapta fata	600	3,00

KINNEGRIP RUNGEN - Typ K20, Aluminiu, 800 mm

Simbol	Cod	Denumire	Inalt. mm	Greutate kg / buc.
	1208242	Stalp intermediar	800	6,00
	1208252	Stalp intermediar cu inaltator	800	6,10
	1208942	Stalp stanga spate	800	6,00
	1208042	Stalp dreapta spate	800	6,00
	1208342	Stalp stanga fata	800	3,00
	1208442	Stalp dreapta fata	800	3,00
		Stalp aluminiu fata stanga de diferite lungimi pana la 3000mm		
		Stalp aluminiu fata dreapta de diferite lungimi pana la 3000mm		












Stalpi Kinnegrip - accesorii Tip K20

Simbol	Cod	Denumire	Lung. ca. m	Greutate kg / buc.
	1007270	profil terminal lateral de 25 mm	6,50	
	1072701	profil terminal lateral de 25 mm anodizat	6,50	
	1007271	Profil terminal spate 25mm	6,50	
	1072711	profil terminal spate de 25 mm anodizat	6,50	
	1030590	garnitura PVC elastica pt.profil 1007270,10072711		
	1045578	garnitura PVC pt.profil 1007270, 1007271		
	1320231	Contrapiesa otel zincat pt. Profil 1007270		0,20
	1032023	Contrapiesa otel pt. profil 1007271		0,20
	1042158	inaltator Stalp 500 mm		2,80
	1042159	inaltator Stalp intermediar 600 mm		3,00
	1042160	inaltator Stalp intermediar 800 mm		3,20
	1012181	prelungitor pt. 500-600 mm		
	1012182	prelungitor pt. 800 - 1000 mm		
	1004424	Top-Kupplung otel din 2 componente L = 80 mm		

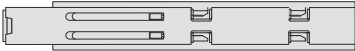





Stalp KINNEGRIP - Accesorii Tip K20

Simbol	Cod	Denumire	Inaltime mm	Greutate kg / buc.
	1032020	Suport sudabil pentru stalp		0,50
	1691801	Suport pt. montaj cu suruburi otel,zincat		0,50
	1032164	Dop plastic mic pt. Stalp fata		0,01
	1032165	Dop plastic mare pt. stalp intermediar si spate		0,02

Stalpi Kinnegrip - Tip IV, 600 + 800 mm

Simbol	Cod	Denumire	Inaltime mm	Greutate kg / buc.
	1004400	Stalp intermediar	600	12,50
	1004423	Stalp intermediar cu inaltator	600	15,50
	1004401	Stalp stanga spate	600	12,30
	1004402	Stalp dreapta spate	600	12,30
	1004403	Stalp stanga fata	600	6,50
	1004404	Stalp dreapta fata	600	6,50
	1004405	Stalp intermediar	800	14,50
	1004406	Stalp intermediar cu inaltator	800	17,10
	1004407	Stalp Spate stanga	800	14,10
	1004408	Stalp Spate dreapta	800	14,10
	1004409	Stalp fata stanga	800	6,80
	1004410	Stalp fata dreapta	800	6,80








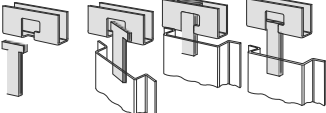
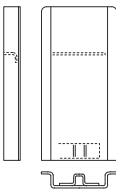
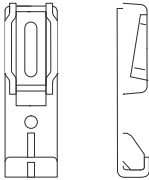
STALP KINNEGRIP - Tip IV, 1000 mm

Simbol	cod.	Denumire	Inalt. ca. mm	Greutate kg / buc.
	1004411	Stalp intermediar	1000	17,20
	1004412	Stalp intermediar cu înaltator	1000	19,70
	1004413	Stalp spate stanga	1000	16,70
	1004414	Stalp spate dreapta	1000	16,70
	1004415	Stalp fata stanga	1000	7,60
	1004416	Stalp fata dreapta	1000	7,60

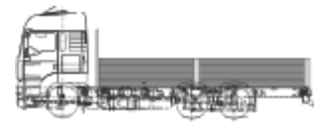
STALPI ITALCAR

1354602	stâlp de 500 mm, stânga-față	2.80
1354802	stâlp de 500 mm, stânga-spate, cu suport	8.70
1354902	stâlp de 500 mm, dreapta-spate, cu suport	8.70
1354502	stâlp de 500 mm, dreapta-față	2.800
1357512	stâlp de 500 mm, mijloc, cu înălțător si suport	8.60
1355002	stâlp de 600 mm, dreapta-față	3.40
1355102	stâlp de 600 mm, stânga-față	3.40
1355232	stâlp de 600 mm, mijloc, cu înălțător si suport	9.50
1355302	stâlp de 600 mm, dreapta-spate, cu suport	9.50
1355402	stâlp de 600 mm, stânga-spate, cu suport	9.50
1355502	stâlp de 800 mm, stânga-spate, cu suport	9.50
1355602	stâlp de 800 mm, dreapta-spate, cu suport	9.50
1355732	stâlp de 800 mm, mijloc, cu înălțător si suport	9.50
1355802	stâlp de 800 mm, stânga-față	3.40
1355902	stâlp de 800 mm, dreapta-față	3.40
1356002	stâlp de 1000 mm, dreapta-față	3.40
1356102	stâlp de 1000 mm, stânga-față	3.40
1356232	stâlp de 1000 mm, mijloc, cu înălțător si suport	9.50
1356302	stâlp de 1000 mm, dreapta-spate, cu suport	9.50
1356402	stâlp de 1000 mm, stânga-spate, cu suport	9.50
1030023	contrapiesă pentru stâlp din otel	0.20

Stalp Kinnegrip - Accesorii Tip IV

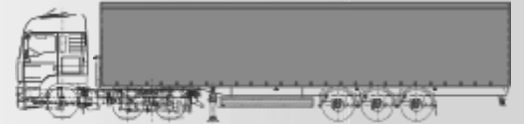
Simbol	Cod	Denumire	Lung. ca. m	Greutate kg / buc.
	1307601	Profil terminal Al pt.stalp Tip K IV	6,00	
	1217971	Profil terminal pt.stalp Tip K IV lateral cu Poliamid, eloxat	3,25	
	1217981	Profil terminal pt.stalp K IV spate cu Poliamid, eloxat	3,25	Tip
	1023009	Insertie filetata din Al Pt. Profil 1021798, 1021797		0,05
	1023011	Distantier pt. Contrapiesa otel pt. cod 1030023 si Profil 1021797, 1021798		0,16
	1004459	Distantier otel Pentru sudura		0,16
	1030023	Distantier din otel zincat cu gauri filetate si suruburi		0,23
	1004424	Top- Kupplung otel din 2 componente L = 80 mm		1,00
	1004418	Inaltator otel pt.stalp Typ IV		1,70
	1004417	Suport stalp pt. stalp Typ IV otel		0,50

Sisteme PRELATA
Dimensiuni dupa solicitare

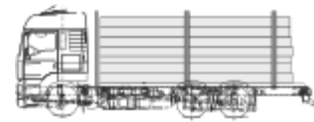


PLATFORME

2.02 Accesorii PRELATA



PRELATE



SISTEME PENTRU LEMN



BASCULANTE



STRUCTURI INCHISE



RAMPE



ACCESORII

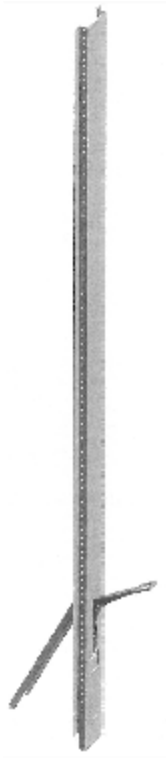

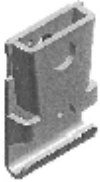




SISTEM TIMO

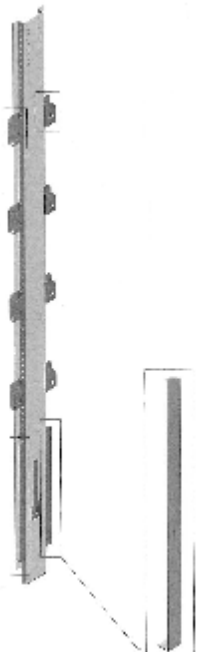


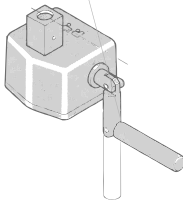






TABLE STRIATE

Accesorii PRELATA




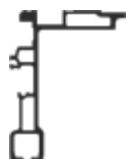
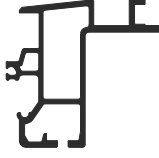

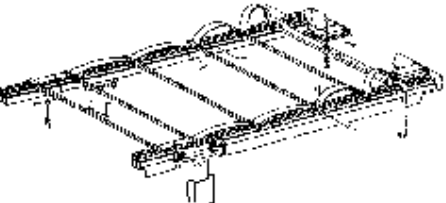
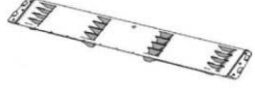
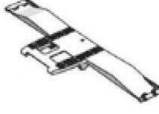

Simbol	Cod	Denumire	Lung. ca. m
	1505014	Sina fara acoperis culisant Dekra testate Adaico	3,00
	28010099	Sina fara acoperis culisant certificata, inclusiv carucior focus	3,00
	28010098	Sina cu acoperis culisant certificata, inclusiv carucior Focus	3,00
	38032400	Carucior pentru stalp Adaico sina 100 mm	
	1506004	Suport Adaico pt.suruburi	
	28030101	Suport Focus sudabil	
	7404177	Etansare Ada slider	

Accesorii PRELATA






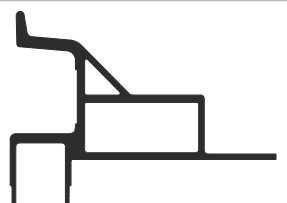
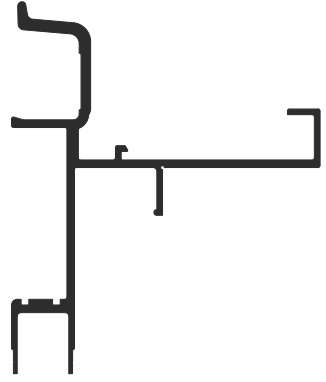
Simbol	COD	Denumire	Lung. ca. m
	1502204	Inaltator Adaico dreapta, sudabil Inalt.=600 mm	
	1502203	Inaltator Adaico stanga, sudabil Inalt.= 600 mm	
	29000682	Inaltator Focus dreapta, pt. nituri, zincat inalt. = 500 mm	
	29000672	Inaltator Focus stanga, pt. nituri, zincat inalt. = 500 mm	
	1502206	Suport dreapta Adaico pt.nituri, KTL	
	1502205	Suport stanga Adaico pt.nituri, KTL	
	29000652	Suport Focus dreapta,zincat	
	29000662	Suport Focus stanga, zincat	
	3110239	Disp. intindere pe dreapta	
	3110238	Disp. intindere pe stanga	
	3110240	Clema pt.dispozitiv intindere	
	3110247	Profil actionare pentru 3110238 3110239	/
	5492041	Profil actionare cu carlig L = 6,5 m Al eloxat	
	3110272	Profil actionare cu carlig L = 3.2 m Al	

PRELATA

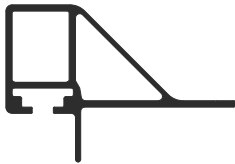
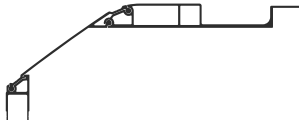
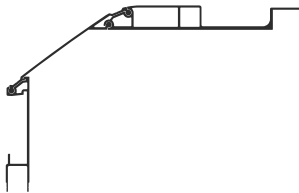


Simbol	Cod	Denumire	Lung. ca. m
	1021070	Profil interior prelată	
	1338201	Mecanism cu clichet dreapta, zincat	
	1338301	Mecanism cu clichete stanga, zincat	
	7022012	Teava intindere prelată Al Ø 34 mm, L=3000mm	
	1043611	Adaptor superior cu stift lung pt. 7022012	
	1043511	Adaptor inferior pt. 7022012	
	1338302	Mecanism cu clichet stanga, zincat B = 37 mm	
	1338202	Mecanism cu clichet dreapta, zincat B = 37 mm	
	7022013	Teava intindere prelată Al Ø 27 mm Pt. mecanism 1338302 / 1338202	
	1043512	Adaptor inferior Pt. teava 7022013	
	1332401	Mecanism antrenare cu manivela detasabila, sudabil pt. teava 7022013	
	1549246	Mecanism antrenare dreapta cu manivela detasabila, cu suruburi, pt. teava 7022013	
	1549247	Mecanism antrenare stanga cu manivela detasabila, cu suruburi, pt. teava 7022013	
	1332451	Cheie pentru mecanism 1332401 / 1549246 / 1549247	

Simbol	Cod	Denumire	Lung. ca. m
	1021142	Profil coperis 60x60 pt .platforme mici cu draperii	6,8
	1005022	sina 100 x 100 pt. acoperis glisant Edscha cu profil din aluminiu brut	7,8 8,3
	7007584	Etansare profil 7007000	
	1805180	sina 162,5 x 35 pt. acoperis Edscha din aluminiu brut	7,7
	1054370	sina 112,5 pt. acoperis Edscha - Ultra Line, din aluminiu brut	7,8
	7055901	Etansare pentru profil 7055900	
	2890900	acoperis glisant Edscha "lite 100" decopertabil monosens lung.ext. 7500mm,latime ext. 2550mm incl. profil terminal, role si etansare	
	2890901	similar lung.ext. 8500mm, latime ext. 2550mm	
	2890902	acoperis glisant Edscha "Ultra line II" decopertabil monosens lung.ext. 7500mm, latime ext. 2550mm	
	7380341	element flexibil din plastic – fixare cu nituri	
	7380342	element flexibil din plastic – fixare cu clipsuri	
	1007701	Mecanism ridicare Hestal 770.1 acoperire KTL incl. ochiuri si telescoape cu gaz	

Accesorii PRELATA

Simbol	Cod	Denumire	Lung. ca. m
	1549212	Profil spate 45 mm latime cu usa integrata din Aluminiu natur, eloxat sau vopsit pt.masini < 40 T	
		adevat pt. draperii	
	1549211	Profil spate 45 mm latime cu inregistarre LBW - BW integrata Aluminiu natur, eloxat sau vopsit pt.masini < 40 T	
		adevat pt. draperii	
	1023714	Profil spate 35 mm latime cu usa integrata din Aluminiu natur, eloxat sau vopsit pt.masini < 15 T	
		adevat pt. draperii	
	1023715	Profil spate 35 mm latime cu inregistarre LBW - BW integrata Aluminiu natur, eloxat sau vopsit pt.masini < 12 T	
		adevat pt. draperii	
	1021139	Profil spate 33 mm latime cadru structural Aluminiu natur, eloxat sau vopsit pt.masini < 7.5 T	
	1549201	Profil fata fara acoperis Pt. remorci si camioane Aluminiu natur, eloxat sau vopsit pt.masini < 26 T	
		adevat pt. draperii	
	1024964	Profil fata pentru constructii de acoperis Pt. remorci si camioane Aluminiu natur, eloxat sau vopsit pt.masini < 26 T	
		adevat pt. draperii	

Accesorii PRELATA

Simbol	Cod	Denumire	Lung. ca. m
	1021138	Profil fata pt.cadru structural Aluminium natur, eloxat sau vopsit pt.masini < 12 T	
	1549202	Profil fata pt.remorci fara acoperis Aluminium natur, eloxat sau vopsit pt.masini < 40 To adevat pt. draperii	
	1549207	Profil fata pt.remorci cu acoperis Aluminium natur, eloxat sau vopsit pt.masini < 40 To adevat pt. draperii	
		Profil usa spate 25 mm livrat asamblat Inalt.interioara 2000 - 3160 mm, latime.exter. 2550 mm cu 3/4 balamale, 4 inchizatoare, asamblare din aluminiu sau otel	
		Usa panou compozit cu placa de 25 mm livrata asamblat Inaltime interioara 2000 - 3160 mm, latime exterioara max. 2550 mm cu 3/4 balamale, 4 inchizatori, rama din otel sau aluminiu Placa compozit acoperita cu aluminiu sau otel Aluminiu brut, eloxat, cu placa compozit lacuita	

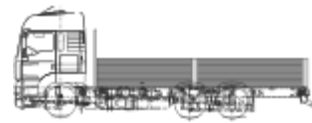
Accesorii PRELATA

Simbol	Cod	Denumire	Lung. ca. m
	1032226	Profil suport prelata 120x 25 mm	
	1045150	Suport din otel pentru profil nr. 1032225	
	1045152	Suport din otel 30mm pentru profil 1032225	
	100284	Teava suport prelata diam.60mm x 1.5mm	
	100393	Teava suport prelata diam. 50mm x 1.5mm	
	1155100	Suport pt.teava D35mm cu pat cauciuc	
	1451551	Suport pt.teava D50mm cu pat cauciuc	
	1004285	Dop plastic pentru suport de prelata	
	1042851	Suport cu cep pentru dop 1004285	

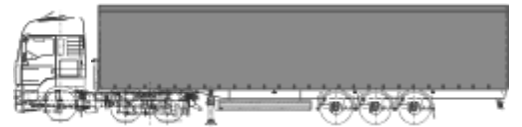
SISTEME PENTRU LEMN
Dimensionare dupa solicitari

3.02 Profile / Accesorii SISTEME PENTRU LEMN

3.03 Sisteme STALPI WOODSTOCK



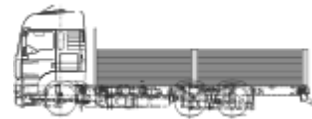
PLATFORME



PRELATE



SISTEME PENTRU LEMN



BASCULANTE



STRUCTURI INCHISE



RAMPE



ACCESORII








SISTEM TIMO




TABLE STRIATE

Sisteme pentru LEMN

Simbol	COD	Denumire	Lung. ca. m
	1088960	Podea pt. sisteme Transport Lemn	5,05
	1008898	profil terminal U pt. sisteme Transport Lemn	6,50
	1088990	profil terminal U pt. sisteme Transport Lemn Margine 60 mm Inaltime 110 mm	6,50
	1000801	Intinzator chinga otel fara chinga	
	1000831	chinga pentru intinzator 100801 rezistenta la strangere 6000 daN	
	1080603	Carlig intinzator 1000801, otel, sudabil	

Sisteme stalpi WOODSTOCK

Simbol	Cod	Denumire	Greutate kg / buc.
 <p>piulite</p>	1004705	Set complet stalp sisteme lemn testat pt. sarcina de 8 T compus din:	160
		2 x Stalpi Aluminiu	
		2 x Prelungitoare din Aluminiu	
		2 x pene din Aluminiu	
		1 x suport din otel	
		2 x insertii otel	
		4 x suruburi cu cap imbuss M 30 x 2 x 35	
		2 x suruburi SKT M 16 x 200	
		2 x	

Notite

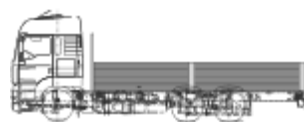
Sisteme BASCULANTE
Dimensionare dupa solicitari

4.02 Oblon EUROTIP 40 / 60

4.03 Oblon EUROTIP 65

4.04 Oblon EUROTIP 40 / 60 / 65

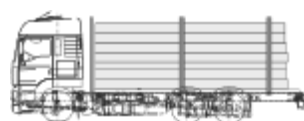
4.05 Accesorii Basculante



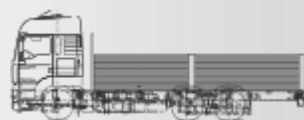
PLATFORME



PRELATE



SISTEME PENTRU LEMN



BASCULANTE



STRUCTURI INCHISE



RAMPE



ACCESORII











SISTEM TIMO



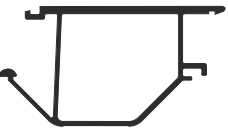
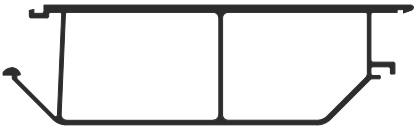



TABLE STRIATE










Oblon basculante EUROTIP 40 / 60

Simbol	Cod	Denumire	Lung. ca. m
	1037238	Profil basculant inferior de 200 mm, cu etanșare laterală Etansare 1151408	7,50 5,80 4,90
	1004649	Profil basculant inferior de 200 mm, cu etanșare inferioară 40 mm	7,50 5,80 4,90
	1038268	Profil intermediar - 200 mm- usor	4,40
	1037242	Profil intermediar - 200 mm	7,50 5,80 4,90
	1037237	Profil intermediar - 100 mm	7,50 5,80 4,90
	1037243	Profil superior 200 mm	7,50 5,80 4,90
	1037258	Profil intermediar 60 mm	7,50 5,80 4,90
	1037257	Profil superior 60 mm	7,50 5,80 4,90

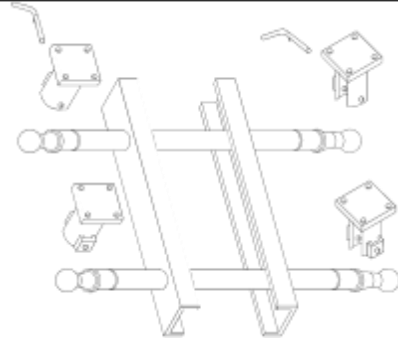
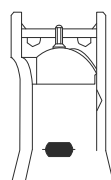
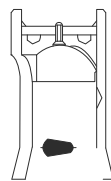
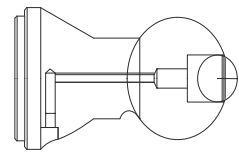
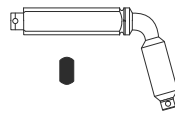
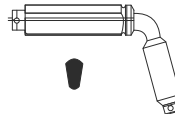
Oblon basculante EUROTIP 65

Simbol	cod.	denumire	Lung. ca. m
	1016746	profil inferior 200 mm	7,50 5,80 4,90
	1543152	profil cadru inferior 300 mm	7,50 5,80 4,90
	1016748	profil intermediar 100 mm	7,50 5,80
	1016747	profil intermediar 200 mm	7,50 5,80 4,90
	1016745	profil superior 200 mm	7,50 5,80 4,90






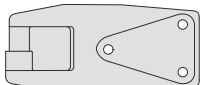
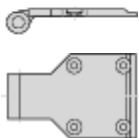
Oblon basculante EUROTIP 40 / 60 / 65

Simbol	Cod	Denumire	Lung. ca. m
	1029079	profil terminal 40/40	6,50
	1020697	profil terminal 65/20	6,50
	100640	profil plat 80 x 20 mm	6,50
	100039	profil plat 40 x 15 mm	6,50
	100040	profil plat 40 x 20 mm	6,50
	100059	platbanda 60 x 20 mm	6,50
	100947	profil plat 70 x 20 mm	6,00
	1151408	Etanșare pentru profil inferior nr. 1050476	
	1063563	Etanșare pentru profil inferior cod 1077843 si 1079481	

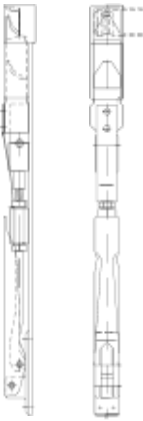
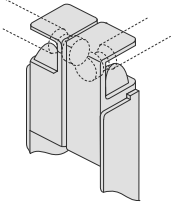

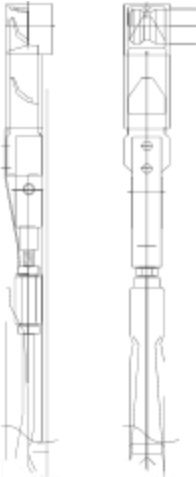
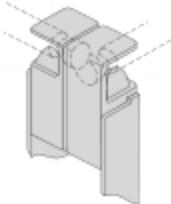

Accesorii BASCULANTE

Simbol	COD	Denumire	Greutate kg / buc.
	1025370	set pivot max. 2 tone (bolțuri sferice și locașuri 4 buc, știfturi 2 buc)	14,30
	1003060	set pivot max. 12 tone (bolțuri sferice și locașuri 4 buc, știfturi 2 buc)	21,70
	1130921	suport articulatie Ø 80 pt.bolt Tip 1	4,00
	1130931	suport articulatie Ø 100 pt.bolt Tip 1	6,50
	1130922	suport articulatie Ø 80 pt.bolt Tip 2	4,00
	1130932	suport articulatie Ø 100 pt.bolt Tip 2	6,50
	1130920	Atenuator vibratii Ø 80 cu orificiu de ungere	5,60
	1130930	Atenuator vibratii Ø 100 cu orificiu de ungere	9,80
	1130923	bolt Ø 80 Tip 1	0,85
	1130933	bolt Ø 100 Tip 1	1,00
	1130924	bolt Ø 80 Tip 2	0,85
	1130934	bolt Ø 100 Tip 2	1,00




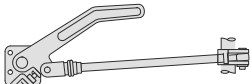
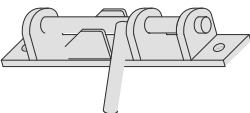
Accesorii BASCULANTE

Simbol	Cod	Denumire	Greutate kg / buc.
	3092117	Placute pt.articulatie sferica 80 mm	
	3092118	Placute pt. articulatie sferica 80 mm	
	3093117	Placute pt. articulatie sferica 100 mm	
	3093118	Placute pt. articulatie sferica 100 mm	
	1000700	balama pentru profil basculant de 40 mm	0,60
	1000725	locas balama pentru profil basculant de 40 mm	0,20
	1000724	Carlig balama pentru profil basculant de 40 mm	0,10
	1001081	placa inchizatorpentru pliere	0,25
	1000778	Suport balama zincat pt. Eurotip 60	1,00
	1000780	placa inchizator	0,45
	1000781	carlig inchizator	0,20
	1004683	surub cap innecat M 8 x 42	0,01
	1000790	Balama pliere	1,00

Accesorii BASCULANTE

Simbol	COD	Denumire	Greutate kg / buc.
	1004345	Inchizator pendula H10 pt. clapeta laterala Oblon Eurotip 40	1,70
	1004349	Inchizator pendula H10 pt. clapeta stanga spate Oblon Eurotip 40	1,70
	1004350	Inchizator pendula H10 pt. clapeta dreapta spate Oblon Eurotip 40	1,70
	1004351	lagar clapeta stanga H10	0,50
	1004352	lagar clapeta dreapta H10	0,50
	1004129	Fus pt. H10	0,40
	1004353	Inchizator pendula H11 Lateral Oblon Eurotip 60	3,00
	1004355	Inchizator pendula H11 spate stanga Oblon Eurotip 60	3,00
	1004356	Inchizator pendula H11 spate dreapta Oblon Eurotip 60	3,00
	1004357	lagar clapeta stanga H11	1,20
	1004358	lagar clapeta dreapta H11	1,20
	1004359	Fus pt H11	0,90

Accesorii BASCULANTE

Simbol	Cod	Denumire	Greutate kg / buc.
	1000740	Fus pentru Hestál 662 NP	0,60
	1000761	Fus pentru Rapid H10	0,60
	1000762	Fus pentru Rapid H11	1,40
	1051930	Inchidere centrala pt. ax Ø 30 mm stanga	2,00
	1051931	similar dreapta	2,00
	1010360	suport alunecare zincat montaj cu suruburi	1,40

Accesorii BASCULANTE

Simbol	COD.	Denumire	Greutate kg / buc.
	1004580	Pompa hidraulică de 12 V, 2 kW, cu panou de comandă și conducte	18
	1004636	Pompa hidraulică de 24 V, 3 kW, cu panou de comandă și conducte	18
	1046587	Cilindru telescopic hidraulic cromat pt. basculare pana la 4 T 6- trepte, cursa 1182 mm cilindrii standard	25
	1046584	Inelul cardanic al cilindrului de forță telescopic	9
	1465841	Inel cardanic pt. cilindru 1046587 Acoperire RAL 9006	9

Notite

STRUCTURI INCHISE

Dimensionare dupa solicitari

5.02 STRUCTURI INCHISE EUROBOX

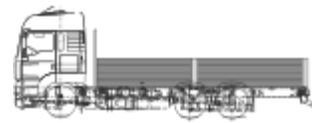
5.06 PANOURI

5.07 FIBRA DE STICLA - GFK

5.08 INCHIZATORI / BALAMALE

5.12 ACCESORII CONSTRUCTIE

5.13 PROFILE ETANSARE



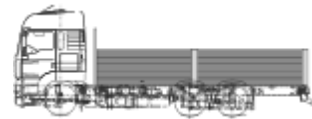
PLATFORME



PRELATE



SISTEME PENTRU LEMN



BASCULANTE



STRUCTURI INCHISE



RAMPE



ACCESORII




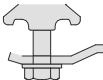
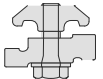







SISTEM TIMO


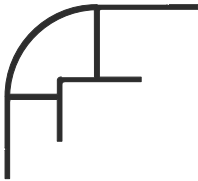

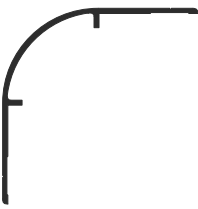
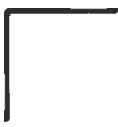
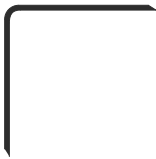

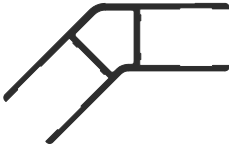


TABLA STRIATA










STRUCTURI INCHISE EUROBOX

Simbol	cod.	Denumire	Lung. ca. m
	1007899	profil cadru interior pentru panee și profile de 25 mm	8,00 6,20
	1078991	profil cadru interior pentru panee și profile de 25 mm, anodizat	
	1007971	profil cadru deschis, pentru traversă de 108 mm	8,00 6,60
	1797111	lonjeron eloxat	
	1007315	traversa 108 mm	7,50 6,60
	1073151	traversa 108 mm eloxat	la cerere
	1642691	set asamblare cu placa zincata	
	1534900	set set de asamblare lonjeron, traversă, cadru	
	1007046 1070463	profil intermediar 200mm profil intermediar 200 mm eloxat	7,50 6,50
	1551841 5518411	profil intermediar 265 mm profil intermediar 265 mm, eloxat	6,20 5,4
	1042795 1427951	profil intermediar 200mm profil intermediar 200 mm, eloxat	7,50 6,50
	1007870	profil colt	6,60
	1078701	profil colt eloxat	
	1089811	profil cadru "I" ANODIZAT	7,50 6,50

STRUCTURI INCHISE EUROBOX

Simbol	Cod	Denumire	Lung ca. m
	1014206	profil terminal pt. remorci, natur	6,50
	1142061	profil terminal pt. remorci eloxat	6,50
	1020517	Profil colț superior, 25/35 mm	8,00 6,50
	1051083	profil omega rigidizare tavan	7,50
	1006817	profil colț exterior	7,50
	1006818	profil colț interior, 60x60 mm	7,50
	1027441	profil colț exterior 80 x 80 mm	7,50
	1274411	profil colț exterior tip L 80 x 80 mm eloxat	7,50
	1003515	profil drenaj Al natur	5,00
	1035151	profil canelat, anodizat	5,00
	1545066	Profil colț 45°	6,60
	1089811	Profil cadru T, anodizat	

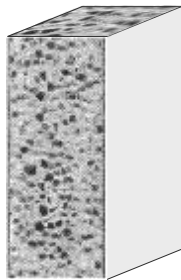
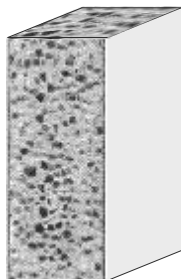
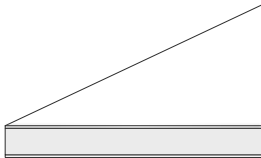
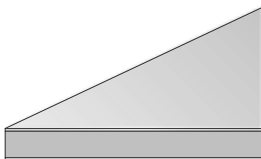
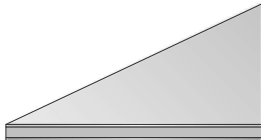
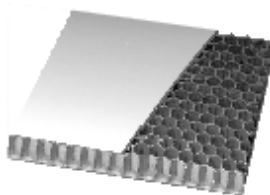
STRUCTURI INCHISE EUROBOX

Simbol	Cod	Denumire	Lung. ca. m
	1007461	Profil protectie interioara 260x50mm	7,50
	1074611	Profil protectie interioara 260x50mm anodizat	
	1074600	Profil protectie interioara drept 260mm anodizat	7,50
	1007462	Profil protectie interioara drept 150mm	
	1006443	profil terminal 20mm	6,00
	1064431	similar eloxat	6,00
	1027179	profil terminal 20 mm	6,00
	1271791	similar eloxat	6,00
	1007212	profil terminal	6,50
	1072121	similar eloxat	6,50
	1027563	Profil terminal 25 mm margine 20 mm	6,50
	1275631	profil terminal "h" de 25 mm eloxat	6,50
	1008066	profil rama usa 25 mm Etansare 1009681 sau 1009680	6,50
	1080661	profil terminal de uşa cu etanşare, anodizat	6,50
	1009681	Etansare cauciuc profil nr. 1008066	0,17 / m
	1009680	Etansare cauciuc mica	0,17 / m

STRUCTURI INCHISE EUROBOX

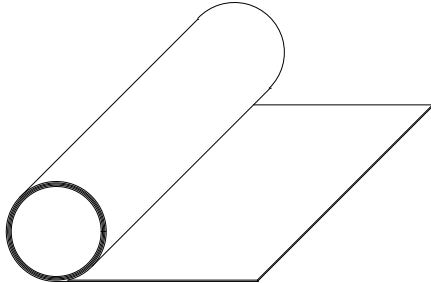
Simbol	Cod	Denumire	Greutate kg / buc.	Lung. ca. m
	1017573	profil terminal 40 mm marginie 30 mm		6,5
	1005791	Balama completa pt. placa 20 mm cu miez plastic		3,00
	1000584	Balama completa 25 mm mit miez otel inox		3,00
	1000245	Banda Tila adancime 29 mm L = 2500 mm	3,60	2,50
	1636371	Balama aluminiu pt. podea L = 2500 mm		2,50
	1636372	balama aluminiu pt. clapa L = 2500 mm		2,50
	1365408	element protectie colț turnat față		0,28
	1365409 0.1	element protectie colț față din material plastic		

PLACI COMPOZIT

Simbol	COD	Denumire	Dimensiuni mm	Greutate kg / m ²	Fact.K Wm.K	
		ALUCOPAN 85 – Placa compozit dintr-un miez din material izolant ambele parti cu folie de aluminiu 1,0 mm grosime. Ambele parti : Folie Al Mn, alb alcuit cu folie de protectie.				
	550019	Alucopan 85	20 2180 5980	7,00	1,35	1495,00
		ECOPAN 85 - Placa compozit dintr-un miez din material izolant acoperit pe ambele parti cu folie fibra de sticla GFK de 1,5 mm grosime. Ambele parti: GFK cu fibra de sticla alba RAL 9010 cu folie de protectie. Pentru acest material exista un variat program de profile si accesorii.				
		Ecopan 85	25 2180 5980	6,40	1,23	
	5000054	Ecopan 85	40 2180 5980	7,00	0,80	
		GFK Compozit	25 2400 6600	6,40		
	5000025					
		ALUCOBOND – Placa din compozit pe ambele parti placata cu foaie de Al 0,5 mm PVDF emailat cu folie de protectie grosime= 4 mm alte grosimi la cerere				
		IPONLight – Placa compozit pe ambele parti acoperita cu folie aluminiu 0,21 mm grosime lacuit pe ambele parti Folie de protectie pe o singura parte grosime = 2 mm sau 3 mm Alte grosimi la cerere				
		ALUCORE - Placa compozit aluminiu structura fagure Rezistenta la incovoiere ridicata si greutate foarte redusa, planeitate superioara si aderență sporita. Permite realizarea fațala de lucrari in arhitectura, construcții, industrie si transport. grosime 6 - 25 mm				
		Taierea la dimensiuni pe masini de debitat este posibila!				

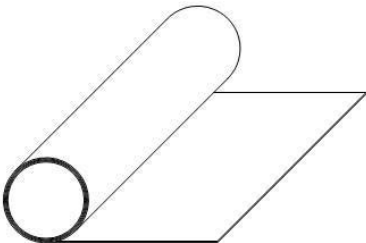
GFK - FIBRA DE STICLA

Simbol	Cod	Denumire	Dimensiuni mm	Greutate kg / m ²
Rola fibra de sticla intarita cu poliester rezistenta la rupere 996 kg/cm ²	1192500	VR 900 R GMB alb RAL 9010 o fata neteda o fata bruta	Gros. 2 Latime 2500 lungim 30000	3,00



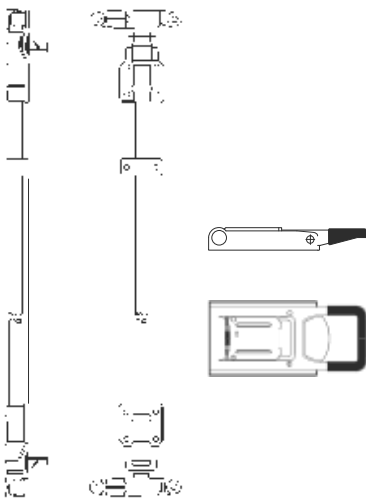
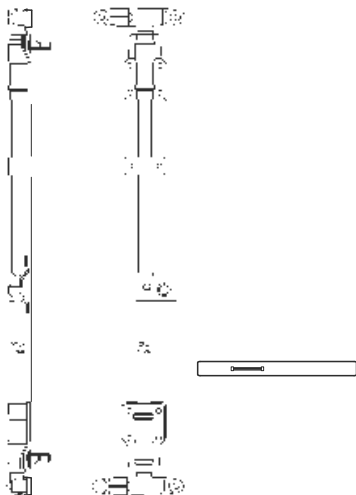
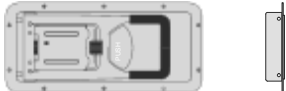
Livrare in toate latimile, lungimi dupa solicitare

Fibră de sticlă cu folie de protecție vopsita alb RAL9010

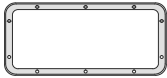



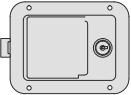
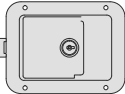


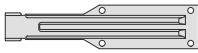

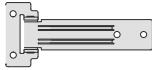
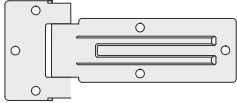
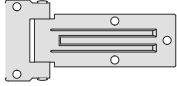
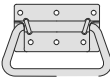


109250015	Fibră de sticlă 1,7x1500x30m	2.30
109250016	Fibră de sticlă 1,7x1600x30m	2.30
109250018	Fibră de sticlă 1,7x1800x30m	2.30
109250019	Fibră de sticlă 1,7x1900x30m	2.30
109250020	Fibră de sticlă 1,7x2000x30m	2.30
109250021	Fibră de sticlă 1,7x2100x30m	2.30
109250022	Fibră de sticlă 1,7x2200x30m	2.30
109250023	Fibră de sticlă 1,7x2300x30m	2.30
109250024	Fibră de sticlă 1,7x2400x30m	2.30
109250025	Fibră de sticlă 1,7x2500x30m	2.30
109250026	Fibră de sticlă 1,7x2600x30m	2.30
109250028	Fibră de sticlă 1,7x2800x30m	2.30
109250115	Fibră de sticlă 2x1500x30m	2.60
109250116	Fibră de sticlă 2x1600x30m	2.60
109250118	Fibră de sticlă 2x1800x30m	2.60
109250119	Fibră de sticlă 2x1900x30m	2.60
109250120	Fibră de sticlă 2x2000x30m	2.60
109250121	Fibră de sticlă 2x2100x30m	2.60
109250122	Fibră de sticlă 2x2200x30m	2.60
109250123	Fibră de sticlă 2x2300x30m	2.60
109250124	Fibră de sticlă 2x2400x30m	2.60
109250125	Fibră de sticlă 2x2500x30m	2.60
109250126	Fibră de sticlă 2x2600x30m	2.60
109250128	Fibră de sticlă 2x2800x30m	2.60

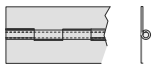
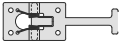

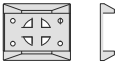
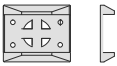
Accesorii INCHIZATOARE / BALAMALE

Simbol	Cod	Denumire	Greutate kg / buc.
	1010021	Inchizator exterior tip bara cu placa de presiune Niro Ø 22mm cu tija 115 mm si anti-rack de prindere fara rotire tija	6,50
Fara imagine	1041201	tija rotativa Niro 22 x 2 x 2500 mm	2,47
	1042401	Inchizator exterior tip bara Niro Ø 22 mm cu tija 115 mm si anti-rack de prindere fara rotire tija	3,49
	1010095	inchizator tip bara incastrat Niro 25,5 mm 322 x 154 mm	1,86
	1010093	inchizator tip bara incastrat Niro 29 mm 322 x 154 mm	1,91
	1020910	inchizator tip bara incastrat Niro 24 mm 122 x 246 mm	1,90

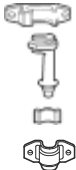
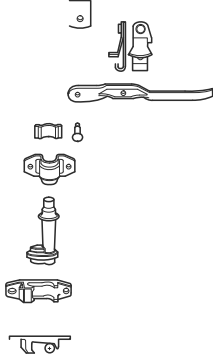
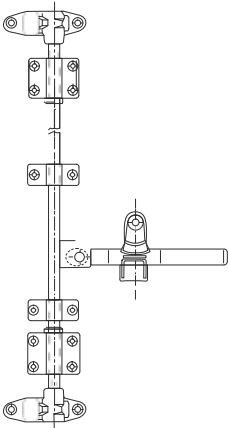
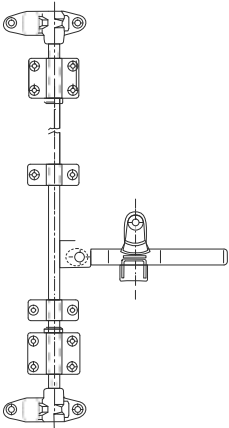
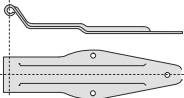

Accesorii INCHIZATORI / BALAMALE

Simbol	Cod	Denumire	Lung. ca. mm
	1037902	Garnitura nylon Pt.inchizator 1010093, 1010095	
	1030923	contrapiesă pentru cârlig nr. 1030903	
	1031207	tija zincata cu carlige sudate Niro pt.fixare orizontala	L~2800 mm
	1031208	tija Niro cu carlige sudate Niro pt.fixare orizontala	L~2800 mm
	1000383	încăstrător încastat pentru ușă laterală de 25 mm	
	1050383	inchizator Niro cu cheie 192 x 64 mm	
	1005181	Corp balama Niro 366 mm, dist.intre gauri 50 mm	
	1005261	Suport balama Niro Pt.suruburi inclusiv bolturi 50 mm	
	1053401	Corp balama Niro 280 mm dist.intre gauri 39,5 mm	
	1054001	Suport balama Niro 38 mm inclusiv bolturi	
	1006151	balama pt. uso laterale, Niro pt.garnitura de 117 mm	
	1050614	balama pt. uso laterale, Niro pt.garnitura de 186 mm	
	1006291	balama pt. uso laterale, Niro pt.garnitura de 133 mm	
	1003331	maner Niro	

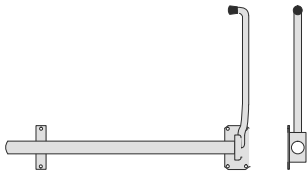
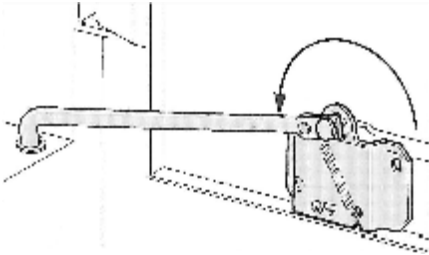
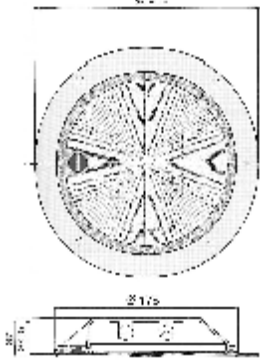
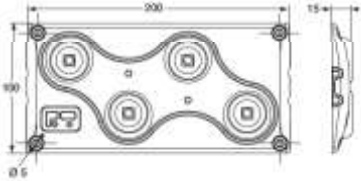
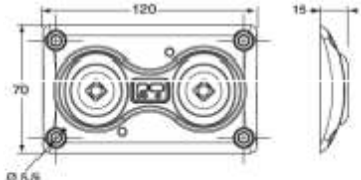
Accesorii INCHIZATORI / BALAMALE

Simbol	Cod	Denumire
	1000624	balama tip piano de 1970x60x2 mm
	1003351	opritor usa Niro (partea mobila)
	1003371	opritor usa Niro (partea fixa)
	1003391	contraplaca pt. 1003351
	1003392	contraplaca pt. 1003371


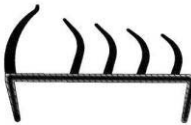
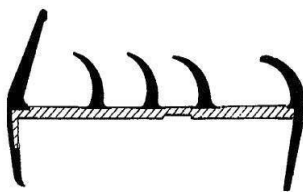

Accesorii INCHIZATORI / BALAMALE

Simbol	Cod	Denumire
	1004542	inchizator cu bara din otel zincat pe dreapta pt. tub 21 x 3 mm fara tija
	1004541	inchizator cu bara din otel zincat pe stanga pt. tub 21 x 3 mm fara tija
fara imagine	1041201	tija tub Niro 22 x 2 x 2500 mm
	1000611	încizător de 27 mm tip bară, exterior, stanga
	1006111	încizător de 27 mm tip bară, exterior, dreapta
	1035701	Tija Niro 27 x 2,5 x 3000 mm
	1080376	balama de 295 mm
	1080380	set suport balama pt. 1080376

Diverse ACCESORII

Simbol	Cod	Denumire	Greutate kg / buc.
	1080296	blocator zincat ușă cu arc	1,90
	1080297	blocator ușă cu arc	1,90
	1000861	Blocator usa stanga pliabil, Niro	0,21
	1008611	Blocator usa dreapta pliabil, Niro	0,21
	1001966	lampa iluminat 12 Volt	0,30
	4052550	lampa iluminat 4 LED, 12 Volt 15 x 200 x 100 mm	
	4052260	lampa iluminat 2 LED, 12 Volt 15 x 120 x 70 mm	

ETANSARI

Simbol	Cod	Denumire	Greutate kg / buc.	Lung. ca. m
	1003021	etansare PVC gri 20mm	2.50	5
	1002383	etansare PVC gri 26mm	3.00	5
	10023301	etansare PVC gri 30mm	1.76	2.7
	1002330	etansare PVC gri 30mm	3.25	5
	10023351	etansare PVC gri 35mm	1.90	2.7
	1002335	etansare PVC gri 35mm	3.50	5
	10023841	etansare PVC gri 40mm	2.16	2.7
	1002385	etansare PVC gri 40mm	4.00	5
	1002384	etansare PVC gri 55mm	2.16	5
		1000065	etansare PVC gri 65mm	4.80
				
	1000083	etansare PVC gri 83mm	3.80	5
				
	1054009	banda acoperire colt	0,01	1,00
				

Notizen

RAMPE

6.02 Profile pt. RAMPE

6.03 ASIGURAREA INCARCATURII



PLATFORME



PRELATE



SISTEME PENTRU LEMN



BASCULANTE



STRUCTURI INCHISE



RAMPE



ACCESORII







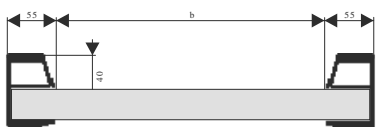
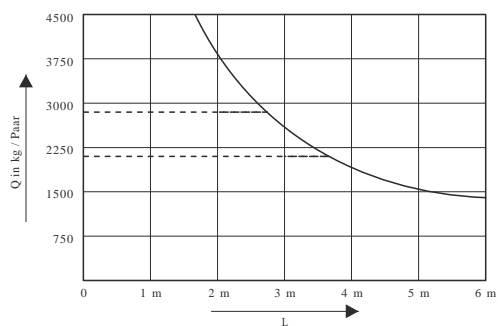
SISTEM TIMO



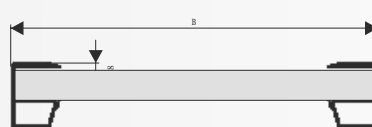
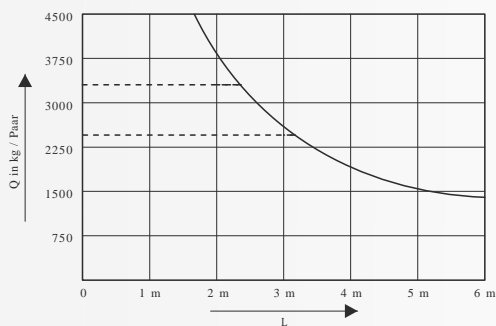
TABLA STRIATA

Profile pt. INCARCATOARE MOBILE + SINE INCARCARE

Simbol	cod	Denumire	Lung. ca. m
	1041095	profil podea pentru rampa de 30 mm	7,50
	1050276	profil de margine pentru rampa	8,00 6,20
	1050062	profil terminal pt. rampa	7,60
	1026371	profil inferior intarit 88 mm	7,35

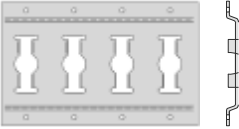
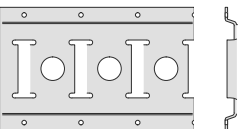
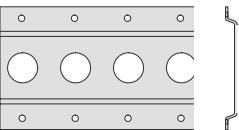
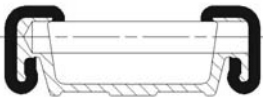





- b = 300 mm
- - - b = 450 mm
- - - b = 600 mm





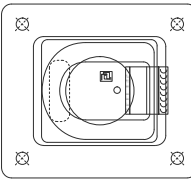
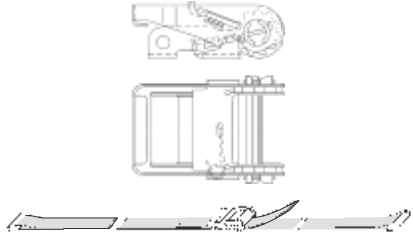


- B = 300 mm
- - - B = 450 mm
- - - B = 600 mm

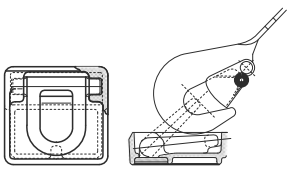
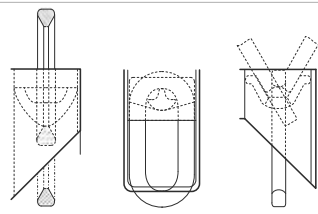
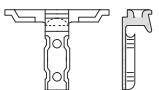
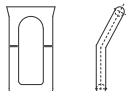
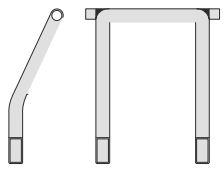


ASIGURAREA INCARCATURII

Simbol	Cod	Denumire	Greutate kg / buc.
	1071219	șină de fixare combinată, din oțel zincat L = 3000 mm B = 133 mm T = 12 mm Gauri Ø = 25 mm	8,00
	1071220	similar Aluminiu	3,00
	1071004	șină de fixare combinată, din oțel zincat, construcție orizontală L = 3000 mm B = 131 mm T = 12 mm gauri Ø = 20 mm	8,00
	1071005	similar aluminiu	2,92
	1071007	șină de fixare combinată cu gauri rotunde zincat auriu L = 3000 mm B = 85 mm T = 12 mm gauri Ø = 20 mm	5,50
	1511034	Sina ancorare Aluminiu L = 3000 mm B = 43 mm T = 25,5 mm	4,20
	1071059	Sina ancorare Aluminiu L = 5000 mm B = 120 mm T = 25 mm	5,00
	1719075	Sina alunecare cu sina fixare integrata oțel 71219 / 140 x 25 mm	
	1719075	similar sina fixare aluminiu 71005	
	1071229	Bara încărcare patrata din Aluminiu pt. sina 1071005, 1071007 Forța de încărcare uniformă admisă 700 daN L = 2380 - 2530 mm	10,00

ASIGURAREA INCARCATURII

Simbol	Cod	Denumire	Greutate kg / buc.
	1071033	bară telesopică, din oțel zincat pentru șină nr. 1071219 și nr. 1071220	8,20
	1071084	bară reglabilă din aluminiu, cu cremalieră sarcina max.ca. 170 daN lung.regl. 2350 - 2720 mm Ø 42 mm	6,30
	1010501	perete separator marfa 122 x 30 mm	
	1001050	cheie fixare între pereti din oțel zincata pentru perete separator marfa	
	1002410	ochi de fixare demontabil, zincat incarcare max.1000 daN	
	1079265	chinga cu clichet pentru șină 1071004, 1071005 1071219, 1071220 lung.stransa: lungime: Forța strângere: latime: 1200 mm 3600 mm 1200 daN 50 mm	

ASIGURAREA INCARCATURII

Simbol	Cod	Denumire
	1071102	ochi de fixare sudat din fontă sarcina 2500 daN
	1071108	ochi de fixare sudat patrat, grunduit sarcina 2000 daN
	1060048	opritor zincat pt. ochi fixare
	1060049	bucla zincata pt. ochi fixare sarcina 2000 daN
fara imagine	1000821	suruburi cap innecat 2 x buc pe set 1060048
	1060050	Ancora pt. cadru 7321 + 7323 + 7326 + 41440 Ø = 10 mm sarcina = 1500 daN
	1000801	Intinzator otel zincat fara farachinga
Fara imagine	1000831	chinga intinzator 1000801 strangere 6000 daN
	1080603	carlig intinzator 1000801, otel sudabil

ACCESORII

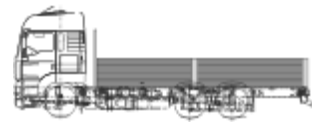
7.02 CUTII SCULE

7.03 SCARI

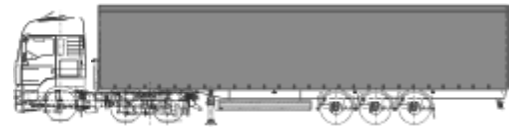
7.04 PROTECTIE ANTIBICICLISTI

7.06 APARATORI

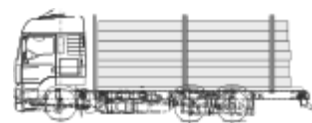
7.08 DIVERSE ACCESORII



PLATFORME



PRELATE



SISTEME PENTRU LEMN



BASCULANTE



STRUCTURI INCHISE



RAMPE



ACCESORII






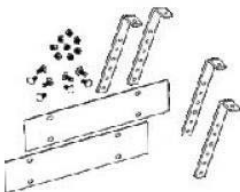


SISTEM TIMO

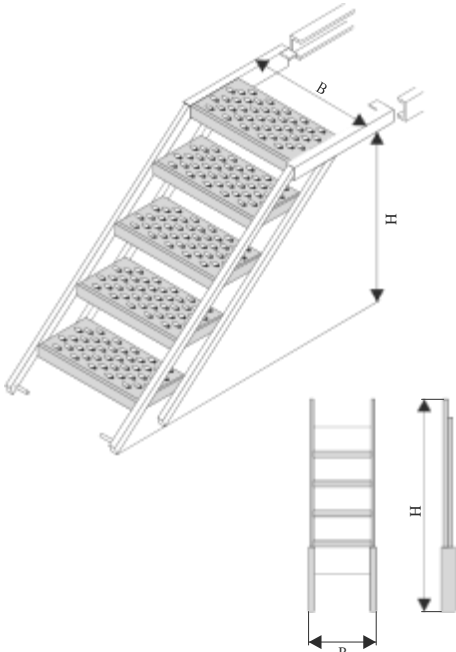
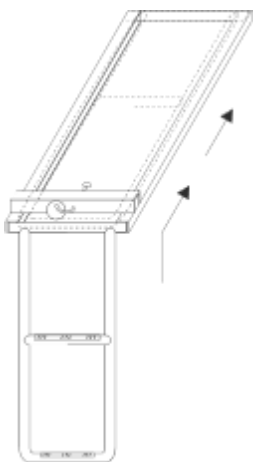
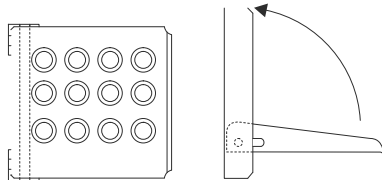


TABLE
STRIATE

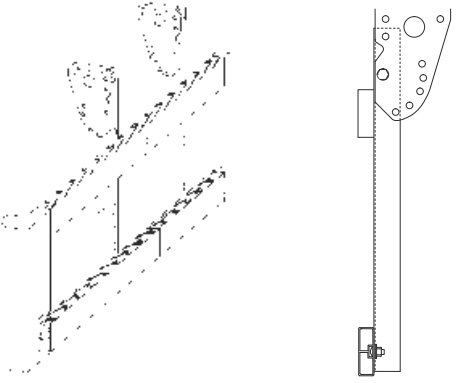
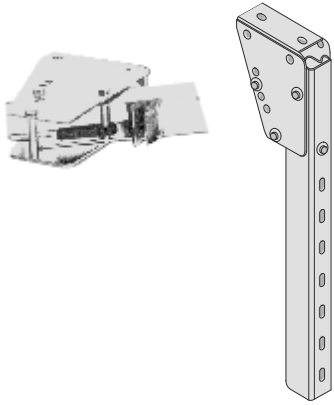




CUTII SCULE

Simbol	cod	Denumire	Greutate kg / buc.
	5042553	cutie scule 500X350X 400 mm cu yale si suport	6,50
	5115000	cutie scule 600 x 400 x 500 mm cu yale si cheie	9,0
	5120000	cutie scule 800 x 500 x 500 mm cu yale si cheie	12,0
	5044100	cutie scule 1000 x 500 x 460 mm cu yale si suport	15
	5042001	cutie pentru stingator 6-9kg	2,9
	1034881	rezervor apa 30l cu suportii	3
		set suport cutii scule (includuse)	

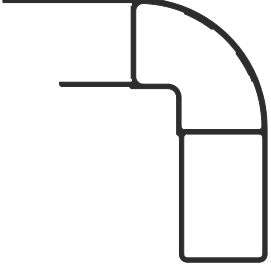


SCARI extensibile, oțel zincat

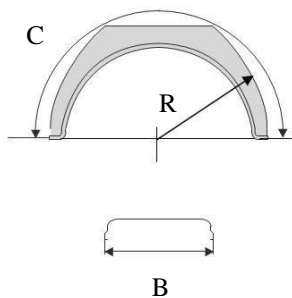
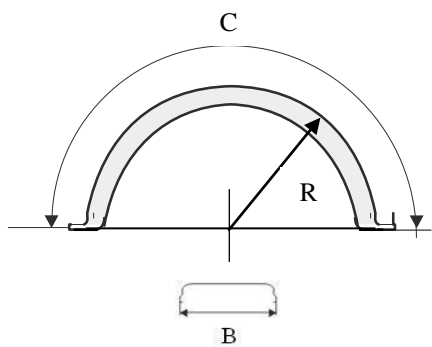
Simbol	Cod	Denumire	Greutate kg / buc.
	1060004	scara extensibila +cadru galvanizata 4 trepte B= 590 mm H= 650 - 800 mm	39
	1060005	scara extensibila +cadru galvanizata 5 trepte B= 590 mm H= 650 - 900 mm	45
	1050161	scara glisanta 2 trepte Oțel zincat	5,10
		1 treapta	la cerere
		3 trepte	la cerere
	1050162	scară glisantă cu o treaptă	la cerere
	1060110	treaptă de urcare pentru oblon, zincată	1,10
	1060111	treapta plianta, interioara oțel zincat	1,10

Accesorii PROTECTIE ANTIBICICLISTI

Simbol	Cod	Denumire	Greutate kg / buc.	Lung. m
	1000255	suport oțel zincat 780 mm reglabil suport SSV-H		4,00
	1000254	suport oțel zincat 572 mm reglabil		4,00
	1008516	Suport SSV-H zincat, 735 mm cu blocare patentata	lung.	4,00
	1009259	profil protectie laterala 120 x 30 mm		6,80
	1006941	profil protectie laterala 100 x 30 mm		7,20
	1069411	similar 100 x 30 anodizat		7,20
	1000041	dop plastic pt. Profil 1006941; 1069411	0,10	
	1000059	dop plastic pt. profil 1009259	0,10	
	1698819	Surub special zincat M 8 x 25	0,10	

Accesorii PROTECTIE ANTIBICICLISTI

Simbol	COD.	Denumire	Greutate kg / buc.	Lung m
	1008585	Profil terminal Aluminiu natur		6,0
	1085851	Profil terminal elem. protectie laterala eloxat		6,0
	1000042	dop plastic pt. Profil 1085851		0,01

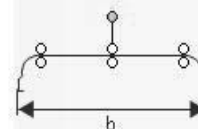
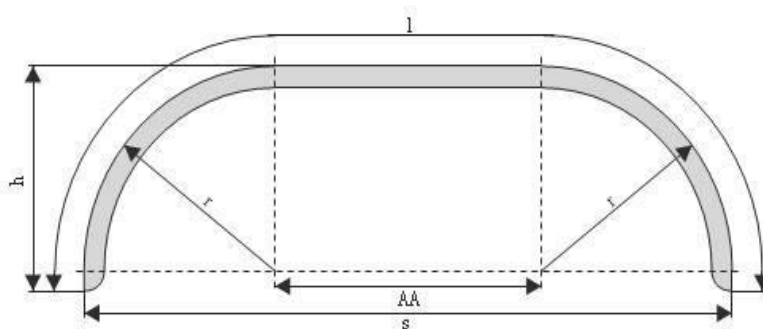


5010217	aripa 680 x 2175 x 650
5020217	aripa 650 x 2175 x 650
5020940	aripa 630 x 1650 x 580
5021178	aripa 600 x 1600 x 580
5023171	aripa 550 x 1700 x 500
5024160	aripa 500 x 1600 x 500
6425000	aripa 500 x 1620 x 510
5025130	aripa 450 x 1300 x 420
6465000	aripa 430 x 2125 x 650
3662000	aripa 430 x 1900 x 650
5026504	aripa 415 x 1420 x 420
5027130	aripa 240 x 1300 x 420

1016523	aripa 650 x 2175 x 660 plată
5024188	aripa 550 x 1880 x 550 plată
5023950	aripa 510 x 1770 x 500 plată
5025137	aripa 460 x 1500 x 450 plată
5025135	aripa 450 x 1300 x 360 plată
5026560	aripa 260 x 1570 x 410 plată

1016536

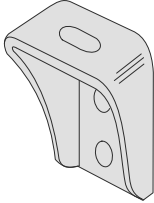
aripa dubla din Aluminiu h = 650
 r = 650
 l = 3550
 s = 2750
 b = 680



APARATORI / PROTECTII

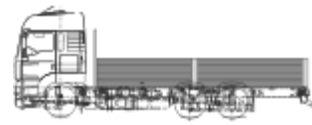
Simbol	COD	Denumire	Greutate kg / buc.
	1008250	bara suport aripa otel zincat	4,50
	1000050	suport aparatoare otel zincat	0,50
	1312610	suport aripa aluminiu eloxat L = 6800 mm	
	1000061	suruburi fixare pt. bara suport 1031260 si 1312601	0,13
	1000037	marcaj contur galben conform ECE 104 amplasare laterala, pt. elemente rigide 50 m / Rola latime = 55 mm	
	1000036	marcaj contur rosu conform ECE 104 amplasare spate, pt elemente rigide 50 m / Rola latime = 55 mm	

Diverse ACCESORII CONSTRUCTIE

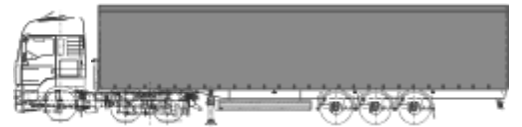
Simbol	Cod	Denumire	Greutate kg / buc.
	1045166	consola zincata din oțel mica pt. prinderea șasiului	0,38
	1451661	similar galvanizata	
	1045163	consola zincata mica H = 75 mm	0,38
	1045177	consolă zincată din oțel pentru prinderea șasiului cu trei gauri	0,55
			0,76
	1045172	consola zincata mare H = 103 mm	
	1451721	similar galvanizata	

Sistem TIMO

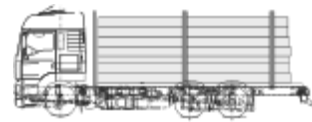
8.02 PREZENTARE SISTEM



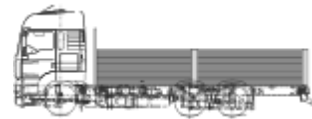
PLATFORME



PRELATE



SISTEME PENTRU LEMN



BASCULANTE



STRUCTURI INCHISE



RAMPE



ACCESORII



SISTEM TIMO



TABLE STRIATE

TIMO

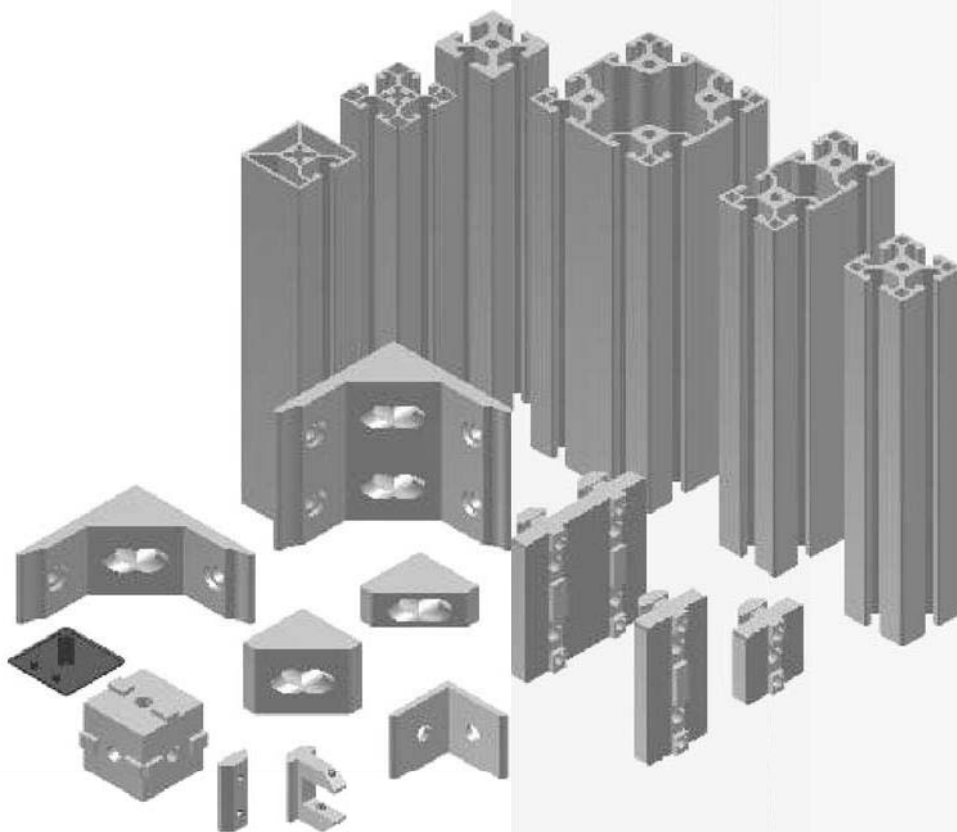
Sistem transport modular
pt.industrie

Este un sistem de profile care aduce solutii inovative in domeniul constructiilor de masini, automatizarii, manipularii, vehicule comerciale si aplicatii industriale.

Profile cu diverse sectiuni transversale si un complet program de accesorii sunt disponibile pentru a satisface diferite criterii de selectie.

Impreuna cu clientii nostri dezvoltam solutii care se concentreaza pe anumite cerinte specifice variabile.

- Sisteme de profile modulare pentru aplicatii versatile
- Profitati de beneficiile dv.aduse de gama noastra extinsa
- Personalul nostru ofera consultanta de specialitate si solutii orientate.

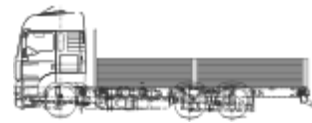


Pentru informatii suplimentare, va rugam sa solicitati catalogul nostru pentru aceste profile sau sa contactati echipa noastra de vanzari

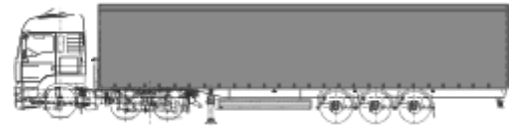
STANDARDS

TABLE SI PLACI

9.08 TABLE STRIATE



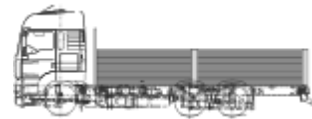
PLATFORME



PRELATE



SISTEME PENTRU LEMN



BASCULANTE



STRUCTURI



RAMPE



ACCESORII



SISTEM TIMO

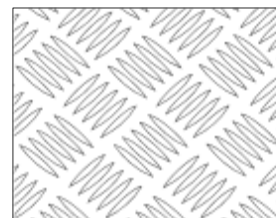


TABLE STRIATE

5754 TABLE STRIATE

EN AW 5754, Al Mg 3
Inaltime striatii 0,5 mm

Cod	Dimensiuni (mm)	Stare	kg/tabla
158 / 134	2/2.5 x 1000 x 2000	H 114	12.20
941	2/2.5 x 1250 x 2500	H 114	18.00
144	2/3.5 x 1000 x 2000	H 114	12.20
145	2/3.5 x 1250 x 2500	H 114	18.03
913	2.5/4 x 1250 x 2500	H 114	24.35
4913	2.5/4 x 1000 x 2000	ENAW 1050	16.25
147	3/4.5 x 1000 x 2000	H 114	18.00
148	3/4.5 x 1250 x 2500	H 114	26.00
149	3/4.5 x 1500 x 3000	H 114	37.50
151	5/6.5 x 1000 x 2000	H 114	27.50
152	5/6.5 x 1250 x 2500	H 114	43.00
153	5/6.5 x 1500 x 3000	H 114	62.00



3003 TABLE STRIATE DIAMOND

EN AW 3003 H224, Al Mg 1 Cu
Inaltime striatii 0,5 mm

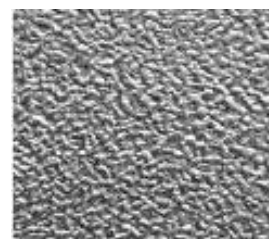
Cod	Dimensiuni (mm)	Stare	kg/tabla
1229	1.5/2 x 1000 x 2000	H 224	8.70
1275	1.5/2 x 1250 x 2500	H 224	13.30



3003 TABLE STUCCO

EN AW 1050

Cod	Dimensiuni (mm)	Stare	kg/tabla
1284	0.8 x 1000 x 2000	H 14 / H 24	4.35



ANEXA TEHNICA

10.2 EUROLOCK

10.4 ZUGANKER 25

10.5 PROFILE MONOBLOC

10.6 PROFILE TERMINALE

10.8 ZUGANKER 30

10.9 PROFILE PALCOM/ PALFIX

10.11 SINE PRELATA & EUROBOX



PLATFORME



PRELATE



SISTEME PENTRU LEMN



BASCULANTE



STRUCTURI INCHISE



RAMPE



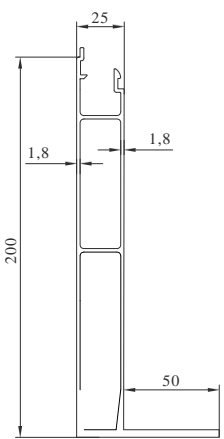
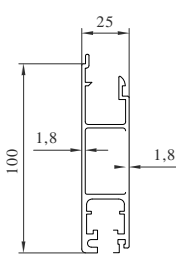
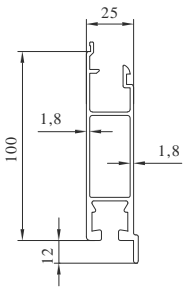
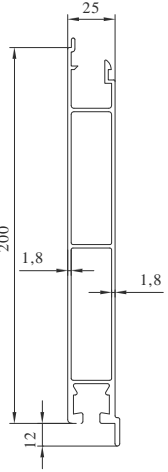
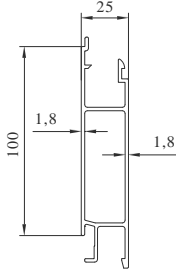
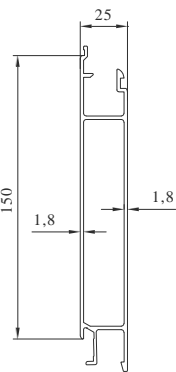
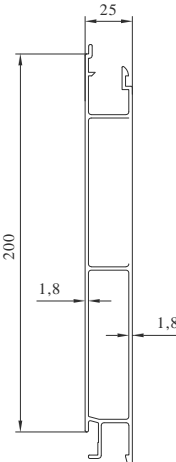
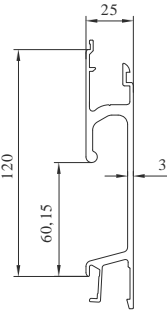
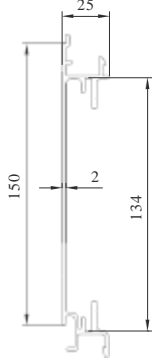
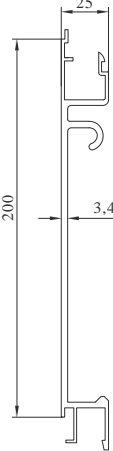
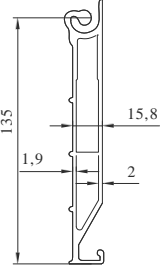
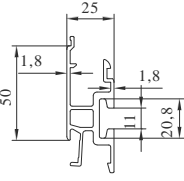
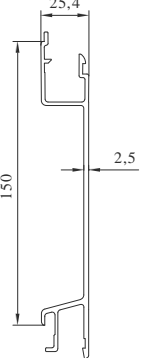
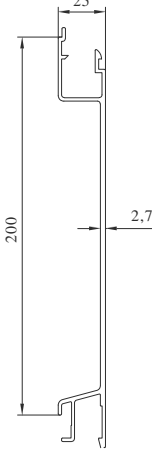
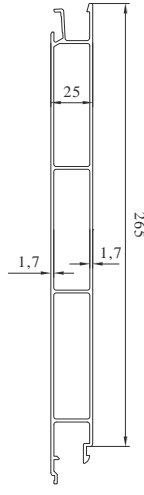
ACCESORII



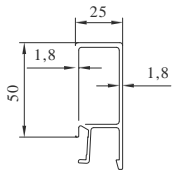
SISTEM TIMO



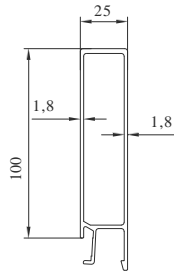
TABLE STRIATE

 <p>Profil nr. 1008244</p>	 <p>Profil nr. 1007948</p>	 <p>Profil nr. 1541755</p>	 <p>Profil nr. 1007783</p>	 <p>Profil nr. 1007785</p>
 <p>Profil nr. 1541497</p>	 <p>Profil nr. 1007046</p>	 <p>Profil nr. 1007786</p>	 <p>Profil nr. 1541503</p>	 <p>Profil nr. 1017569</p>
 <p>Profil nr. 1017570</p>	 <p>Profil nr. 1023439</p>	 <p>Profil nr. 1018233</p>	 <p>Profil nr. 1007045</p>	 <p>Profil nr. 1551841</p>

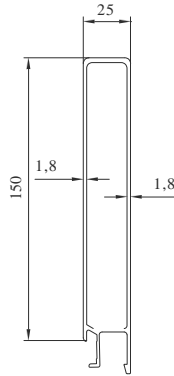
EUROLOCK
Anexa Tehnica



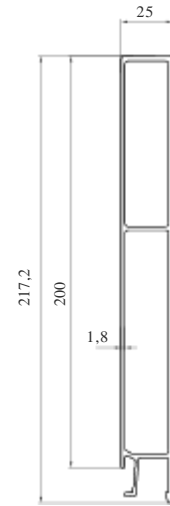
Profil nr. 1012934



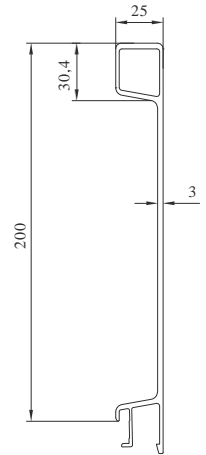
Profil nr. 1007048



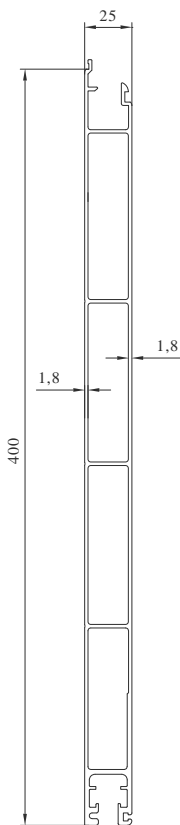
Profil nr. 1018450



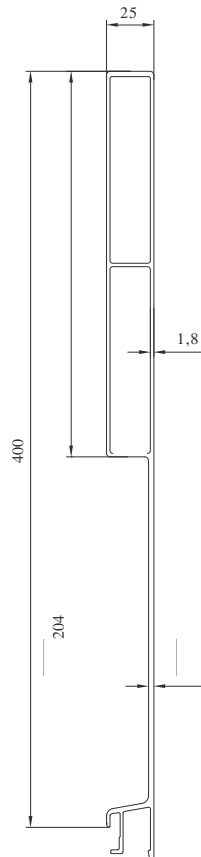
Profil nr. 1007047



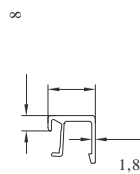
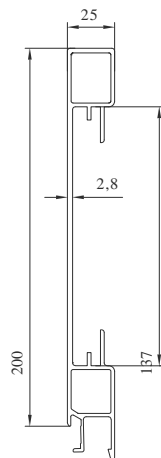
Profil nr. 1541753

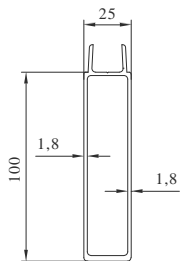


Profil nr. 1541593

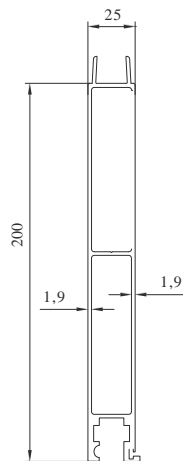


Profil nr. 1012894

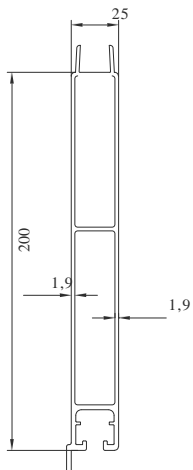




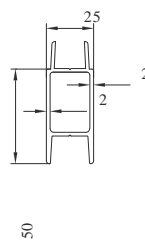
Profil nr. 1044730



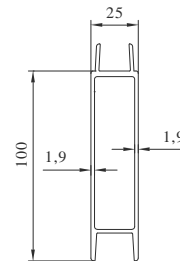
Profil nr. 1070191



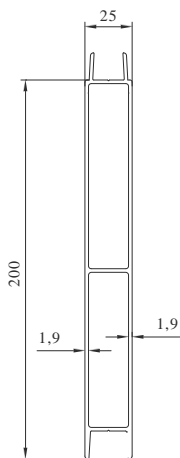
Profil nr. 1049063



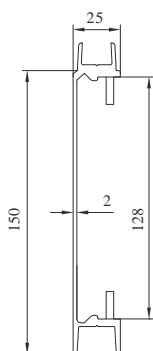
Profil nr. 1035914



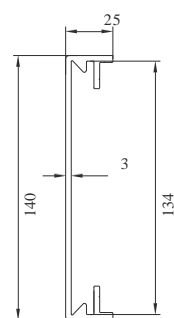
Profil nr. 1042794



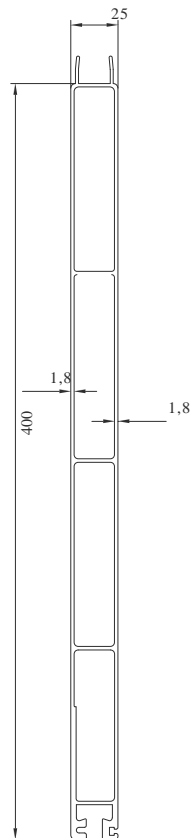
Profil nr. 1042795



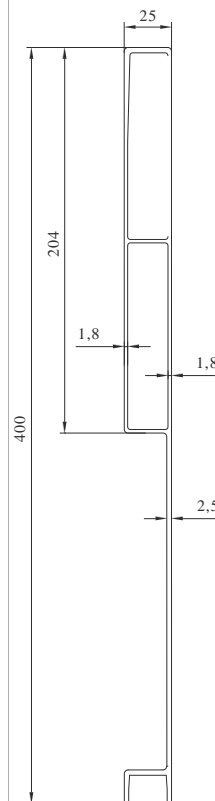
Profil nr. 1719092



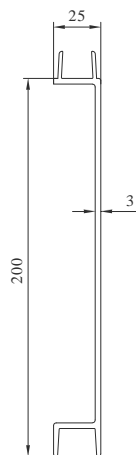
Profil nr. 1719074



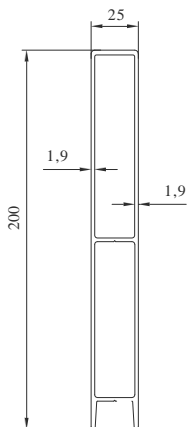
Profil nr. 1701140



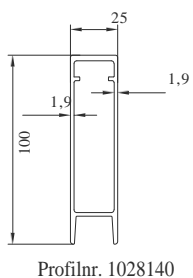
Profil 1701138



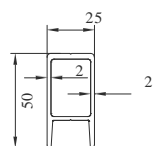
Profil nr. 1042798



Profil nr. 1042796

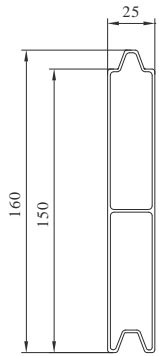


Profilnr. 1028140

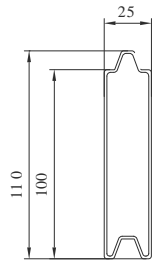


Profil nr. 1029126

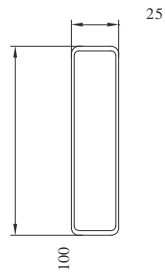
PROFILE MONOBLOC
Anexa Tehnica



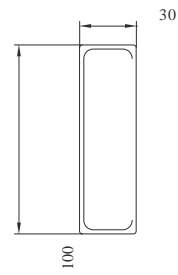
Profil nr. 10007336



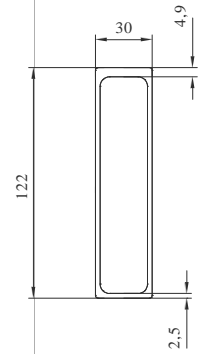
Profil nr. 1004766



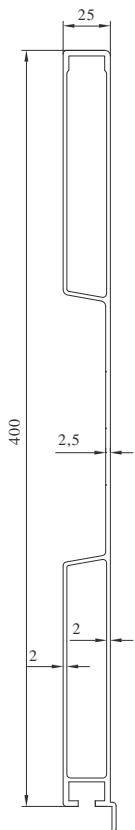
Profil nr. 1032225



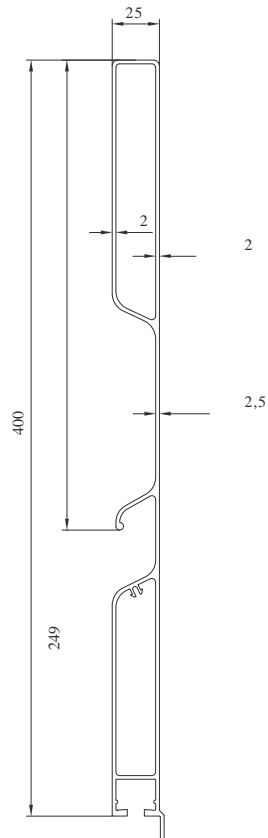
Profil nr. 1041088



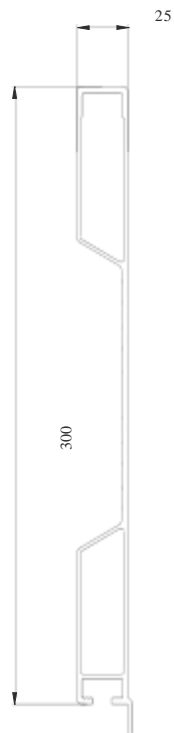
Profil nr. 1032871



Profil nr. 5418431

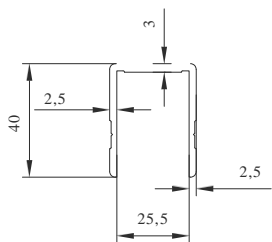


Profil nr. 1033651

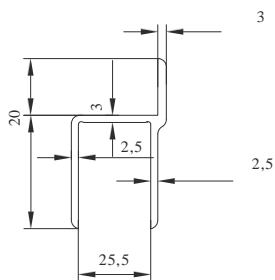


Profil nr. 1256551

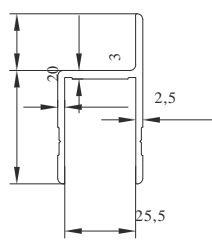
PROFILE TERMINALE
Anexa Tehnica



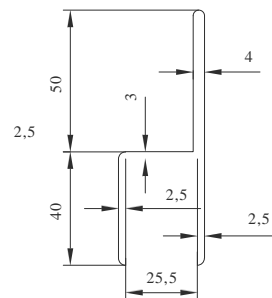
Profil nr. 1007212



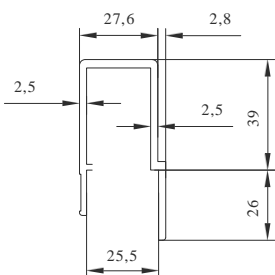
Profil nr. 1027563



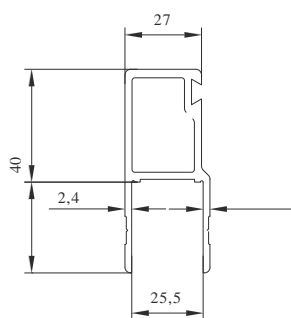
Profil nr. 1007214



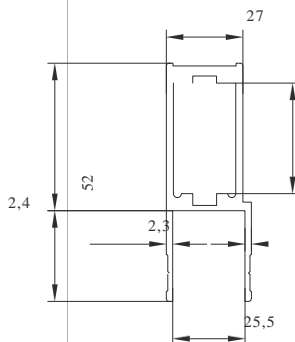
Profil nr. 1017572



Profil nr. 1008830

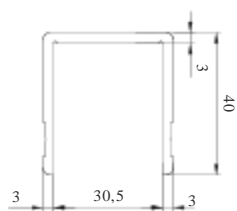


Profil nr. 1025259

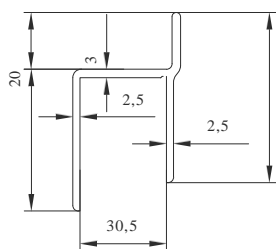


Profil nr. 1610004

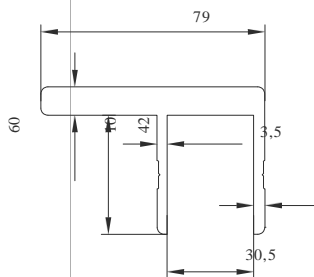
39
2



Profil nr. 1040696



Profil nr. 1024907

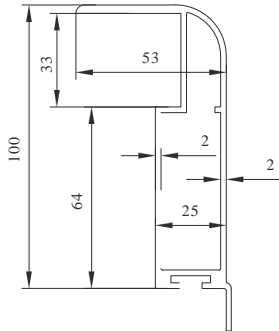


Profil nr. 1032410

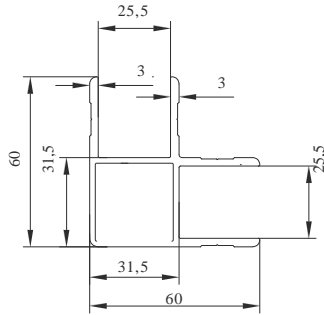
4

PROFILE TERMINALE

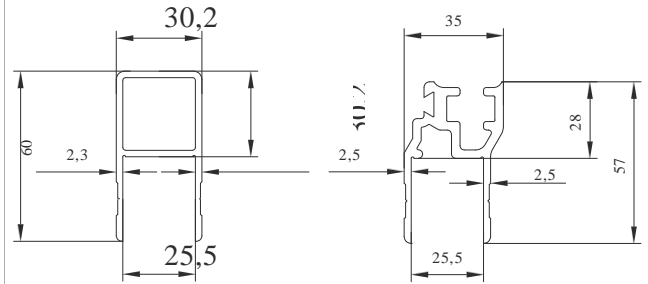
Anexa Tehnica



Profil nr. 1044580

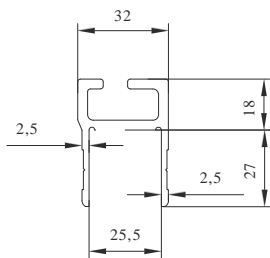


Profil nr. 1007870

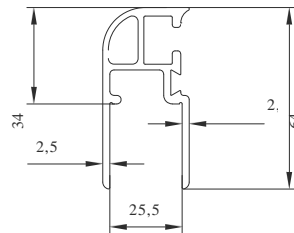


Profil nr. 1014206

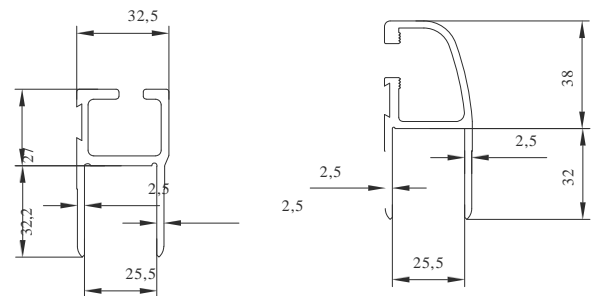
Profil nr. 1007270



Profil nr. 1030760

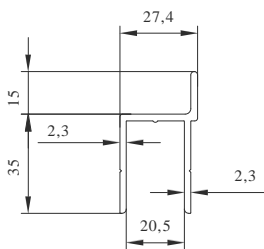


Profil nr. 1007271

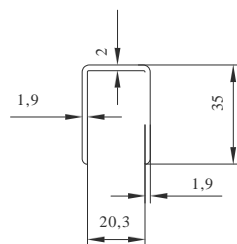


Profil nr. 1021797

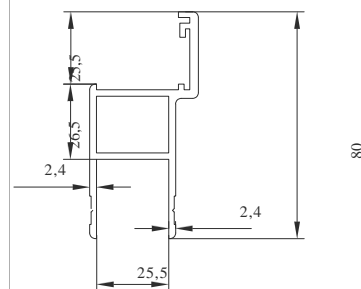
Profil 1021798



Profil nr. 1027179



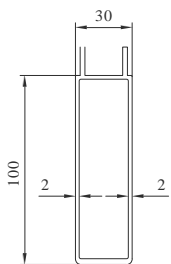
Profil nr. 1006443



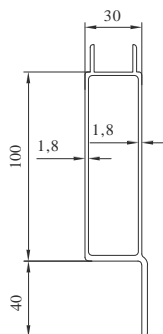
Profil nr. 1008066

PROFILE ZUGANKER 30

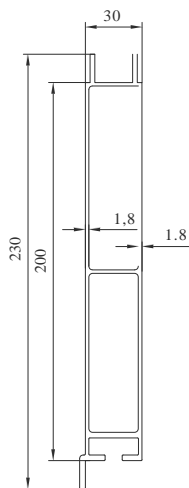
Anexa Tehnica



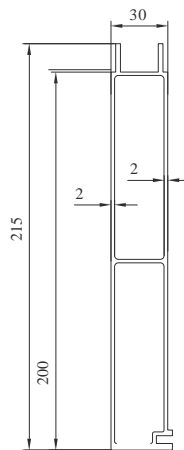
Profil nr. 1032949



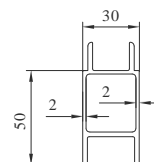
Profil nr. 1022713



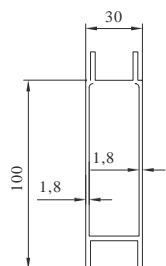
Profil nr. 1000121



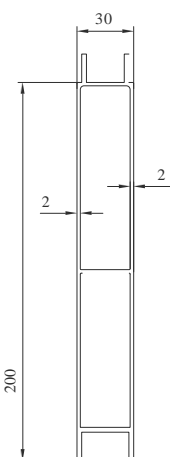
Profil nr. 1050476



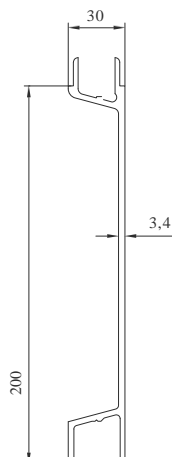
Profil 10U/66/



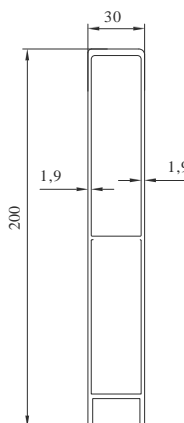
Profil nr. 1005728



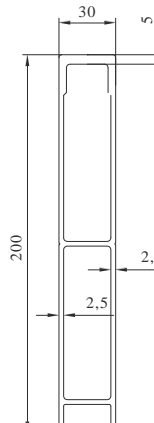
Profil nr. 1037374



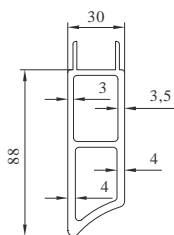
Profil nr. 1046021



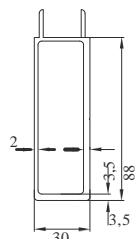
Profil nr. 1037373



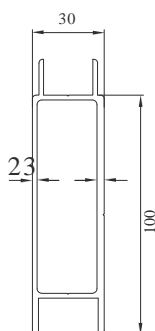
Profil 1373732



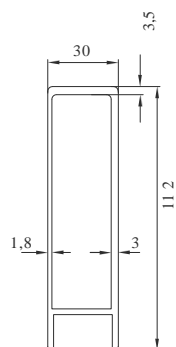
Profil nr. 1026371



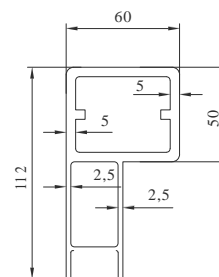
Profil nr. 1037377



Profil nr. 1037376

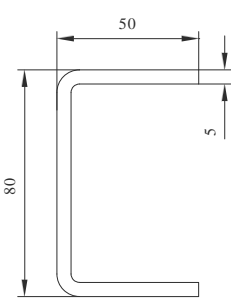
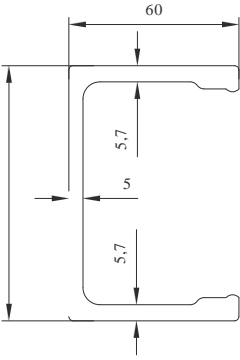
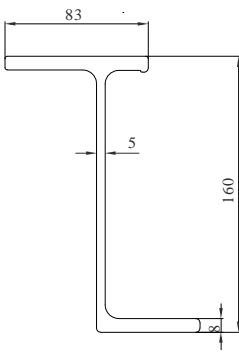
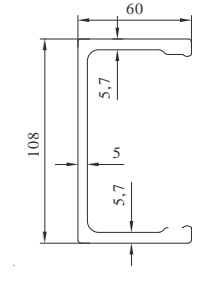
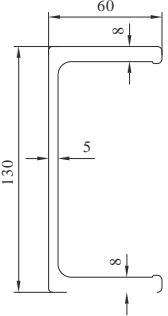
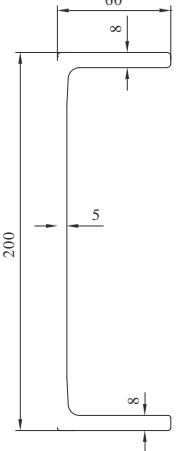
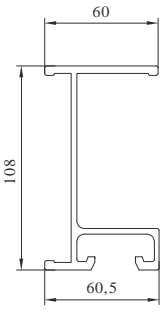
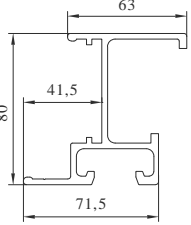
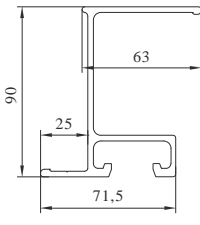
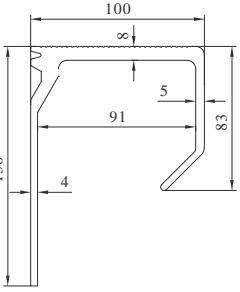
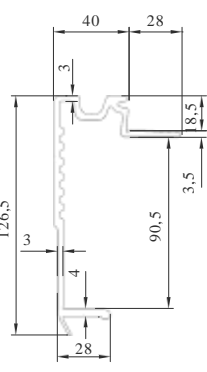
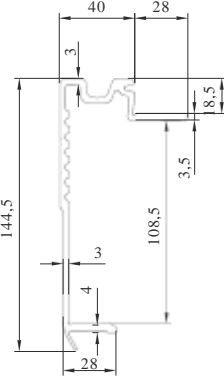
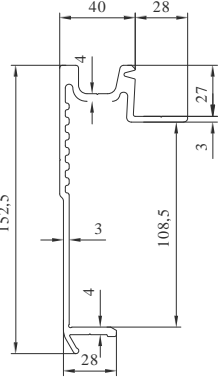
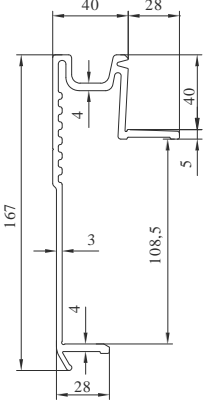
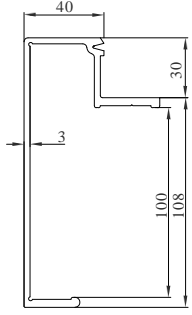


Profil 1037375

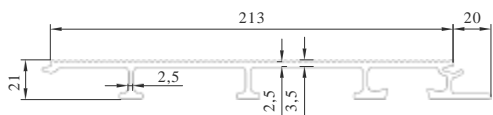


Profil 1026646

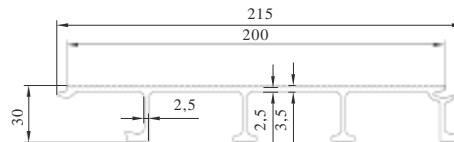
PALCOM / PALFIX
Anexa Tehnica

 <p>Profil nr. 1006409</p>	 <p>Profil nr. 1007316</p>	 <p>Profil nr. 1052362</p>	 <p>Profil nr. 1007317 Profil nr. 1007324</p>	 <p>Profil nr. 1080370 Profil nr. 1054477</p>
 <p>Profil nr. 1031491</p>	 <p>Profil nr. 1007315</p>	 <p>Profil nr. 1024548</p>	 <p>Profil nr. 1007317 Profil nr. 1007324</p>	 <p>Profil nr. 1080370 Profil nr. 1054477</p>
 <p>Profil nr. 1007323</p>	 <p>Profil nr. 1007321</p>	 <p>Profil nr. 1007326</p>	 <p>Profil nr. 1041440</p>	 <p>Profil nr. 1007545</p>

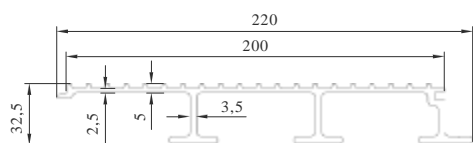
PALCOM / PALFIX & BALAMALE / PROFILE TERMINALE K20, Typ K IV
Anexa Tehnica



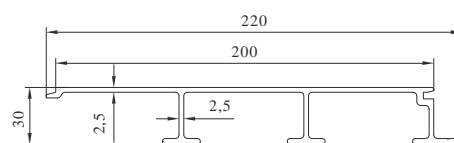
Profil nr. 1007542



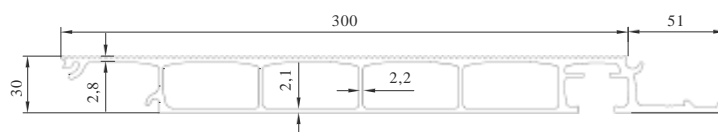
Profil nr. 1007543



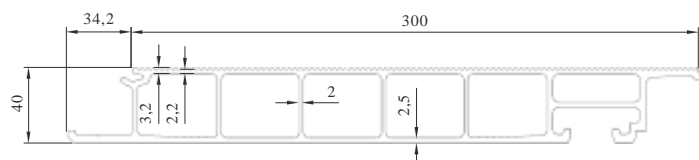
Profil nr. 1041095



Profil 1041960

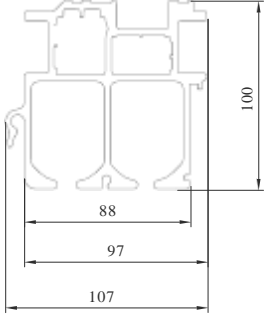
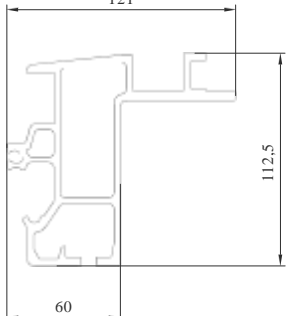
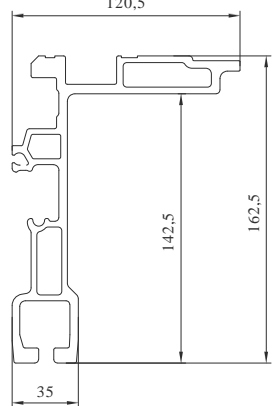
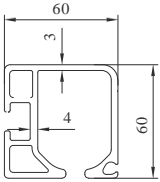
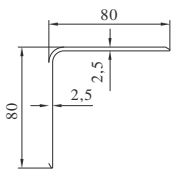
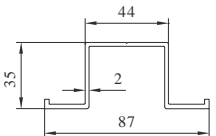
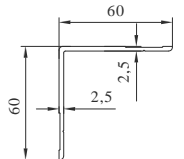
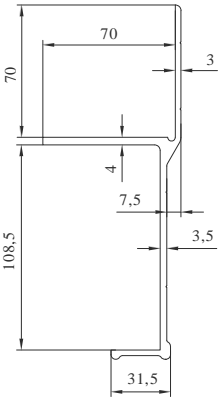
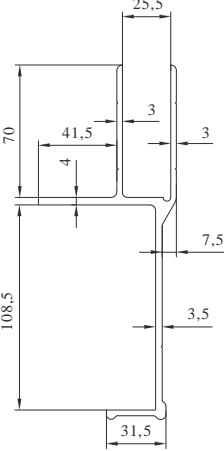
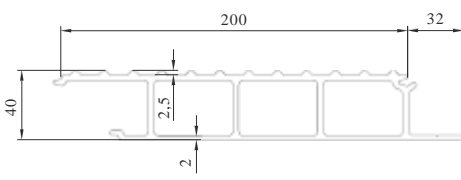
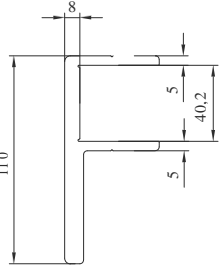
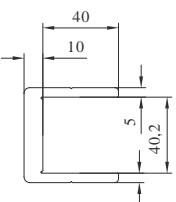
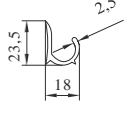
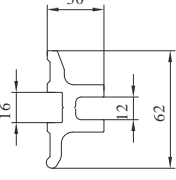


Profil nr. 1027485

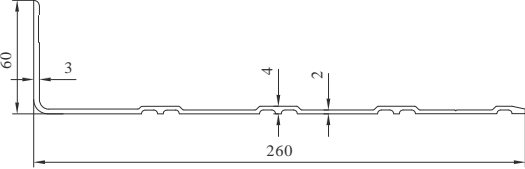
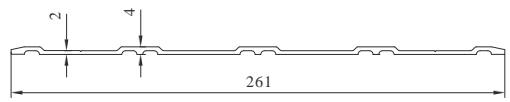
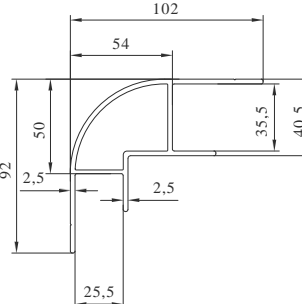
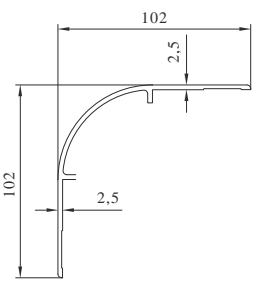
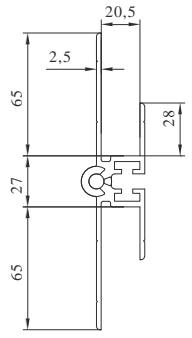
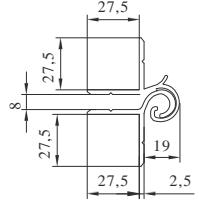
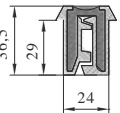
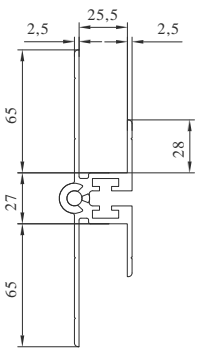
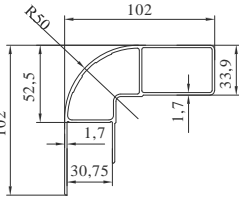
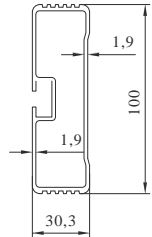
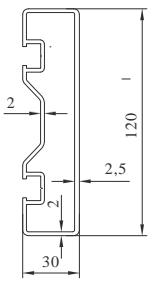
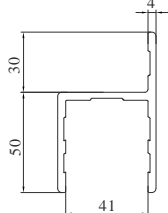
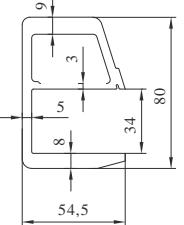
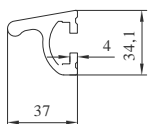
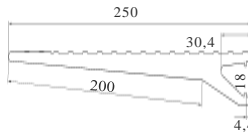
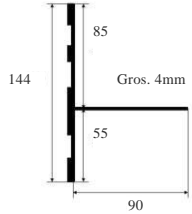


Profil nr. 1041055

SINE PRELATA & EUROBOX
Anexa Tehnica

 <p>Profil nr. 1005022</p>	 <p>Profil nr. 1054370</p>	 <p>Profil nr. 1805180</p>	 <p>Profil nr. 1021142</p>
 <p>Profil nr. 1027441</p>	 <p>Profilnr. 1051083</p>  <p>Profil nr. 1006818</p>	 <p>Profil nr. 1007971</p>	 <p>Profil nr. 1007899</p>
 <p>Profil nr. 1088960</p>	 <p>Profil 1088990</p>	 <p>Profil nr. 1008898</p>	 <p>Profil 1003515</p>
		 <p>Profil 1021070</p>	

EUROBOX
Anexa Tehnica

 <p>Profil nr. 1007461</p>	 <p>Profil nr. 1007460</p>			
 <p>Profil nr. 1020517</p>	 <p>Profil nr. 1006817</p>	 <p>Profil nr. 1005791</p>	 <p>Profil nr. 1636371 / 1636372</p>	
 <p>Profil nr. 1000245</p>	 <p>Profil nr. 1000584 Profil nr. 1026371</p>	 <p>Profil nr. 1008585</p>	 <p>Profil 1006941</p>	 <p>Profil 1009259</p>
 <p>Profil nr. 1017573</p>	 <p>Profil nr. 1050276</p>	 <p>Profil 1312610</p>	 <p>Profil 1050062</p>	 <p>Profil 1006941</p>

SISTEM PRELATA DECOPERTABILA

DIMENSIONARI DUPA SOLICITARE

